

RADIAL LEADED PTC RG MODEL

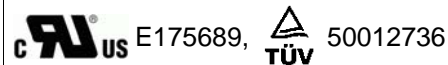

■ FEATURES

- Very high hold current, Solid state
- Radial-leaded product ideal for up to 16Vdc
- Operation current: 3A~14 A
- Maximum voltage: 16V
- Temperature range -40°C to 85°C
- Cured, flame retardant epoxy polymer insulating material meets UL 94V-0 requirement
- Bulk packing, tape and reel available on most models

■ APPLICATIONS

- Audio Equipment
- Automotives Electronic
- Fire Alarm/ Security System
- Halogen Light
- Medical/ Test Equipment
- Wire Harness

■ PART NUMBERING SYSTEM

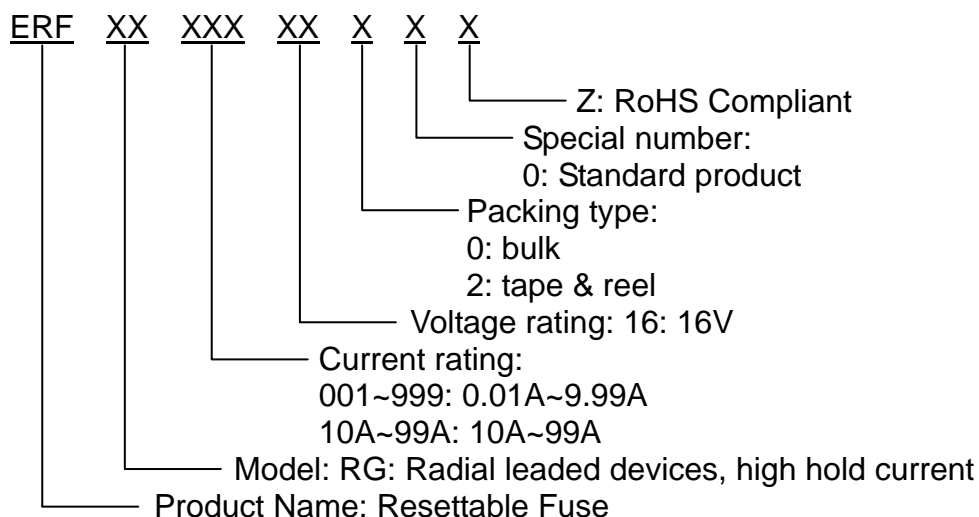

NOTE: Specifications subject to change without prior notice.

■ Marking system

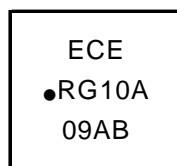

Example

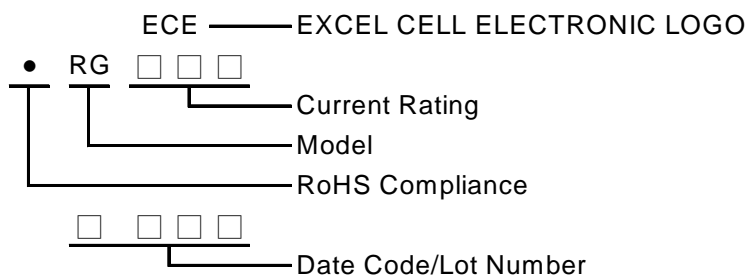

■ Electrical characteristics(23°C)

Part Number	Hold Current	Trip Current	Max. Time to trip	Maximum Current	Rated Voltage	Typical Power	Resistance Tolerance	
							R _{MIN}	R _{1MAX}
	I _H , A	I _T , A	at 5xI _H	I _{MAX} , A	V _{MAX} , V _{dc}	P _d , W	Ω	Ω
RG300-16	3.0	5.1	2.0	100	16	2.3	0.034	0.105
RG400-16	4.0	6.8	3.5	100	16	2.4	0.020	0.063
RG500-16	5.0	8.5	3.6	100	16	2.6	0.010	0.044
RG600-16	6.0	10.2	5.8	100	16	2.8	0.009	0.033
RG700-16	7.0	11.9	8.0	100	16	3.0	0.006	0.021
RG800-16	8.0	13.6	9.0	100	16	3.0	0.005	0.018
RG900-16	9.0	15.3	12.0	100	16	3.3	0.004	0.015
RG10A-16	10.0	17.0	12.5	100	16	3.3	0.003	0.012
RG11A-16	11.0	18.7	13.5	100	16	3.7	0.003	0.010
RG12A-16	12.0	20.4	16.0	100	16	4.2	0.002	0.009
RG14A-16	14.0	23.8	20.0	100	16	4.6	0.002	0.008

I_H=Hold current-maximum current at which the device will not trip at 23°C still air.

I_T=Trip current-minimum current at which the device will always trip at 23°C still air.

V_{MAX}=Maximum voltage device can withstand without damage at its rated current.

I_{MAX}= Maximum fault current device can withstand without damage at rated voltage (V max).

P_d=Typical power dissipated from device when in the tripped state in 23°C still air environment.

R_{MIN}=Minimum device resistance at 23°C.

R_{1MAX}=Maximum device resistance at 23°C 1 hour after tripping .

NOTE: Specifications subject to change without prior notice.

■ **Typical Time-To-Trip at 23°C**

- A=RG300-16
- B=RG400-16
- C=RG500-16
- D=RG600-16
- E=RG700-16
- F=RG800-16
- G=RG900-16
- H=RG10A-16
- I=RG11A-16
- J=RG12A-16
- K=RG14A-16

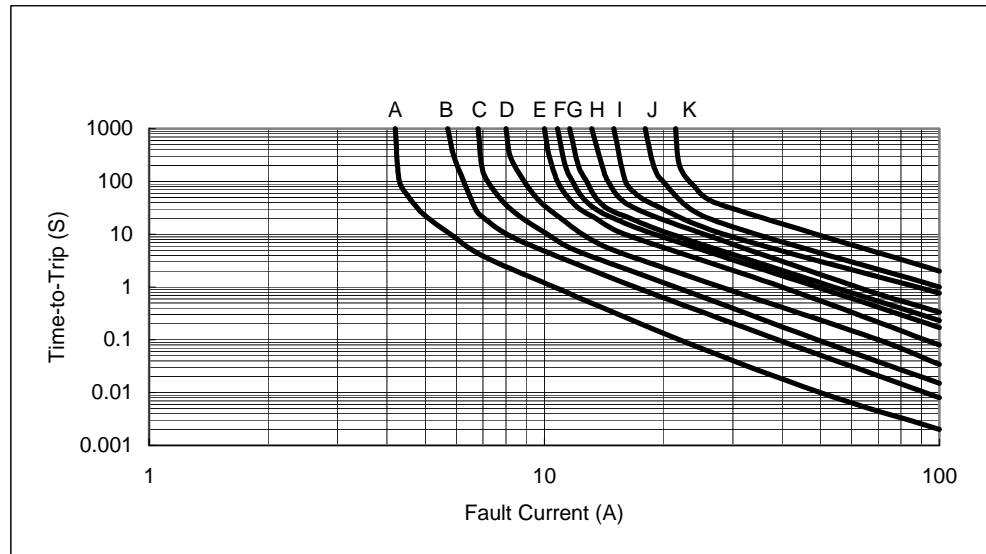

■ **Thermal Derating Curve**

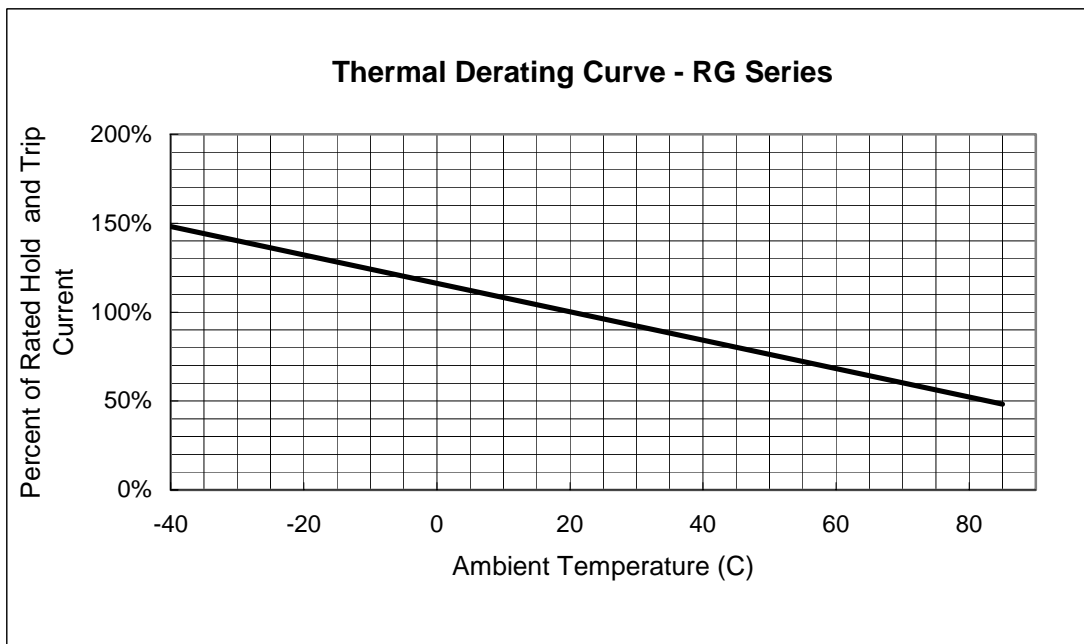

NOTE: Specifications subject to change without prior notice.

■ **RG Product Dimensions (UNIT: mm)**

Part Number	A	B	C	D	E	F
	Maximum	Maximum	Typical	Minimum	Maximum	Typical
RG300-16	7.1	11.0	5.1	7.6	3.0	1.2
RG400-16	8.9	12.8	5.1	7.6	3.0	1.2
RG500-16	10.4	14.3	5.1	7.6	3.0	1.2
RG600-16	10.7	17.1	5.1	7.6	3.0	1.2
RG700-16	11.2	19.7	5.1	7.6	3.0	1.2
RG800-16	12.7	20.9	5.1	7.6	3.0	1.2
RG900-16	14.0	21.7	5.1	7.6	3.0	1.2
RG10A-16	16.5	24.1	5.1	7.6	3.0	1.2
RG11A-16	17.5	26.0	5.1	7.6	3.0	1.2
RG12A-16	17.5	28.0	10.2	7.6	3.6	1.4
RG14A-16	27.9	27.9	10.2	7.6	3.4	1.4

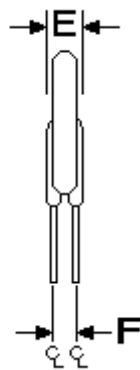
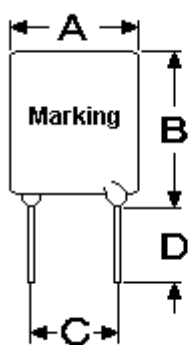

RG 300-16 ~ RG 11A-16

- Lead Size: 20AWG
- \varnothing 0.81mm Diameter

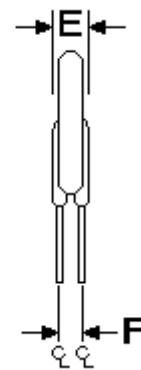
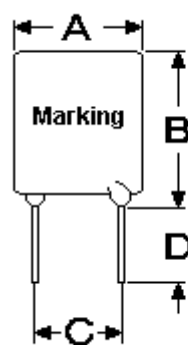

RG 12A-16 ~ RG 14A-16

- Lead Size: 18AWG
- \varnothing 1.0mm Diameter

NOTE: Specifications subject to change without prior notice.