

ESPE-9012-P3

- high quality desktop 12 V power supply

FEATURES:

- compact design
- high power output
- premium class design
- fully protected

APPLICATIONS:

- consumer electronics
- office equipment
- general purpose
- computer devices
- POS, POI equipment



ESPE-9012-P3 is a compact and efficient 90-watt desktop power unit for various types of electronic devices. It is based on high quality electronic components that allow continuous, long-lasting work in all conditions. It is reliable, fully secured and stable. It provides high efficiency and excellent specification.

TECHNICAL SPECIFICATION

Group	Parameter	Value	Conditions
Input	Rated input voltage	100-240 VAC	
	Input voltage range	90-264 VAC	
	Mains frequency range	47-63 Hz	
	AC current (max.)	2.2 A	At 100 VAC and full load
	Inrush current (max.)	50 A	
	No load power consumption	0.15 W	
	Input leakage current (max.)	Max. 0.5 mA	At 264 VAC
Output	Rated output voltage	12 V	
	Rated output power	90 W	
	Rated output current	7.5 A	
	Average efficiency	88%	
	Efficiency at 10% load	86.4%	At 230 VAC
	Line regulation	±3%	
	Load regulation	±5%	
	Ripple and noise	150 mVp-p	At 100 VAC
	Minimal output current	No	
	Hold up time (max.)	Over 5 ms	At 100 VAC and full load
	DC voltage rise time (max.)	Up to 40 ms	At 100 VAC and full load
	Turn on delay time (max.)	Up to 1.5 s	At 100 VAC and full load
Environmental	Working temperature	0 to +40°C	
	Working humidity	25% to 75% RH	40°C
	Storage temperature	-10°C to +80°C	
	Cooling method	Free air circulation	
Protection	Short circuit	Yes	
	Overcurrent	Yes	
	Output overvoltage	Yes	
	Automatic recovery on fault remove	Yes	
Safety and EMC	Withstand isolation voltage	1.5 kVAC (input to output)	5 mA, 1 min
	Isolation resistance	100 MΩ	500 VDC
	Isolation class	1	
	Safety compliance	EN62368	
	EMC compliance	EN55022 class B	
	Marking	RoHS, CE	
Mechanical and features	Enclosure	Black ABS plastic	
	Dimension	155 × 60 × 35 mm	D × S × W
	Weight	400 g	
	Output connector	DC Jack 2.1 × 5.5 × 10 mm	Plus in the middle
	Input connector	IEC320 C13 3-pole socket	
	Output cable	1.2 m	1.3 mm ²
	Single package	188 × 72 × 70 mm	
	Packing	400 × 165 × 370 mm	20 pieces
	Warranty	China	3 years

Notes:

Unless otherwise stated, all parameters are specified at 230 VAC input voltage, 50 Hz, ambient temperature 25°C and relative humidity 70% for rated load output. The values of parameters related to the output voltage regulation is measured from low to high line or for load changes from 0 to 100%, respectively. The power supply is considered as an independent unit, but the final equipment still need to reconfirm that the whole system complies with the EMC directives. If the PSU is installed in the final device as a subassembly, the tests should be repeated to verify that the system has been met compliance. Detailed technical data are available on request.

BLOCK DIAGRAM

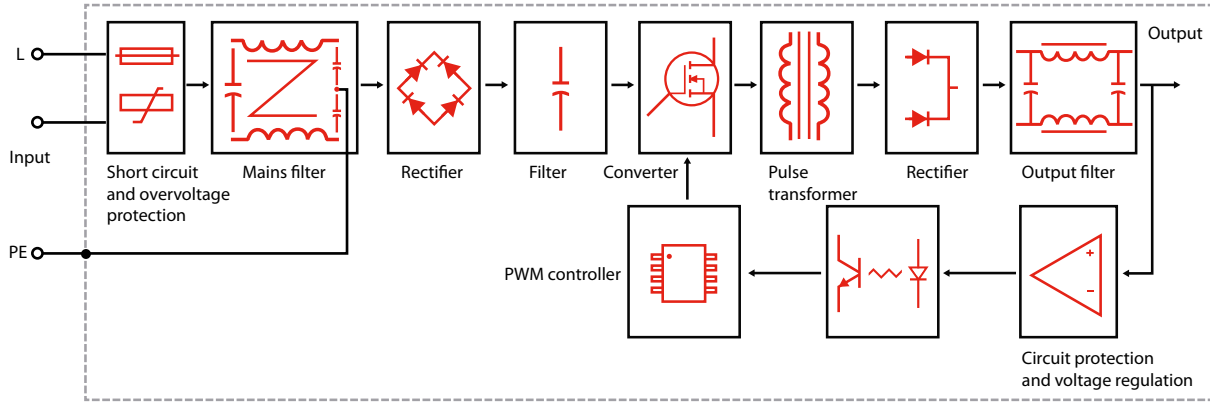

MECHANICAL SPECIFICATION

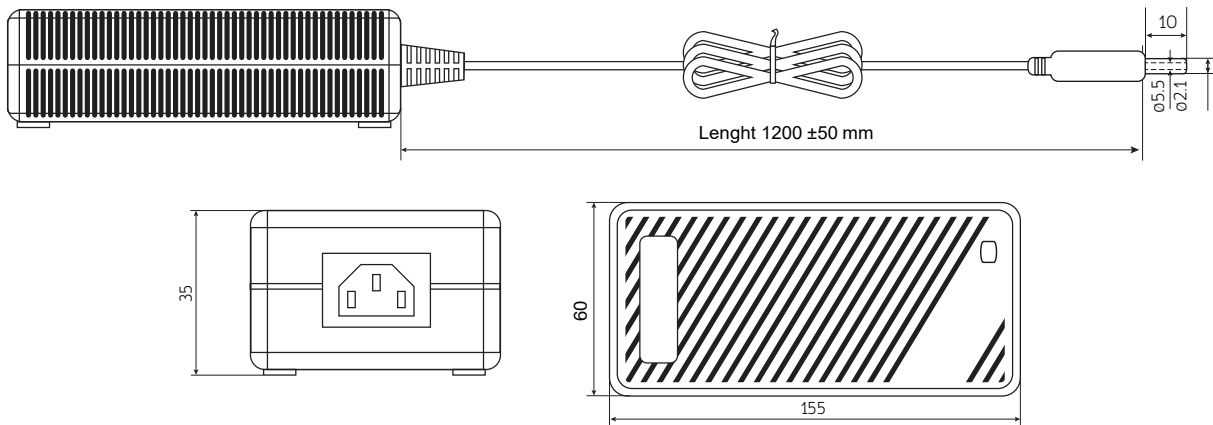

PRODUCT LABEL



Legend to the label icons:

- power supply intended for indoor use only
- means safety isolating control gear with short circuit protection
- polarization: plus in the middle, minus outside
- the product must not be disposed of in normal waste containers

MARKING SYSTEM

ESPE-9012-P3

- Input socket type **P3**
- Rated output voltage **12 V**
- Output power **90 W**
- Family **ESPE**

OTHER POWER SUPPLIES IN THIS SERIES

Model	ESPE-3612-T2	ESPE-6012-T2	ESPE-9012-P3	ESPE-12012-P3	ESPE-9024-P3	ESPE-12024-P3
Rated output voltage	12 V	12 V	12 V	12 V	24 V	24 V
Rated output current	3 A	5 A	7.5 A	10 A	3.75 A	5 A
Rated output power	36 W	60 W	90 W	120 W	90 W	120 W
Efficiency	88%	89%	88%	85%	89%	89%
Plug type	DC Jack 2.1×5.5×11 mm – straight			DC Jack 2.1×5.5×10 mm – straight		DC Jack 2.1×5.5×11 mm – angled