



HELUKABEL®



HELUTOP®

**For every application
the correct cable gland**

www.helukabel.de

Welcome at HELUKABEL®



Headquarters Hemmingen



The Logistic Centre Hemmingen



Cables & Wires



Special Cables



Cable Accessories



Data, Network & Bus Technology



Media Technology



Robotics

Today, HELUKABEL® GmbH is one of Germany's leading cable companies, boasting an extensive range of cables, wires, special cables, media technology and wires, as well as cable accessories and data, networks and bus technology.

We design, manufacture and supply for all markets and for all applications. Our extensive warehouse stock, containing over 33.000 articles, enables us to deliver your order within extremely short times.

The catalogue provides a full overview of all products in our HELUTOP® cable gland range. We continuously update our wide range to keep abreast of market requirements. Our internal and field service team is happy to provide you with assistance in finding the best solution for your needs.

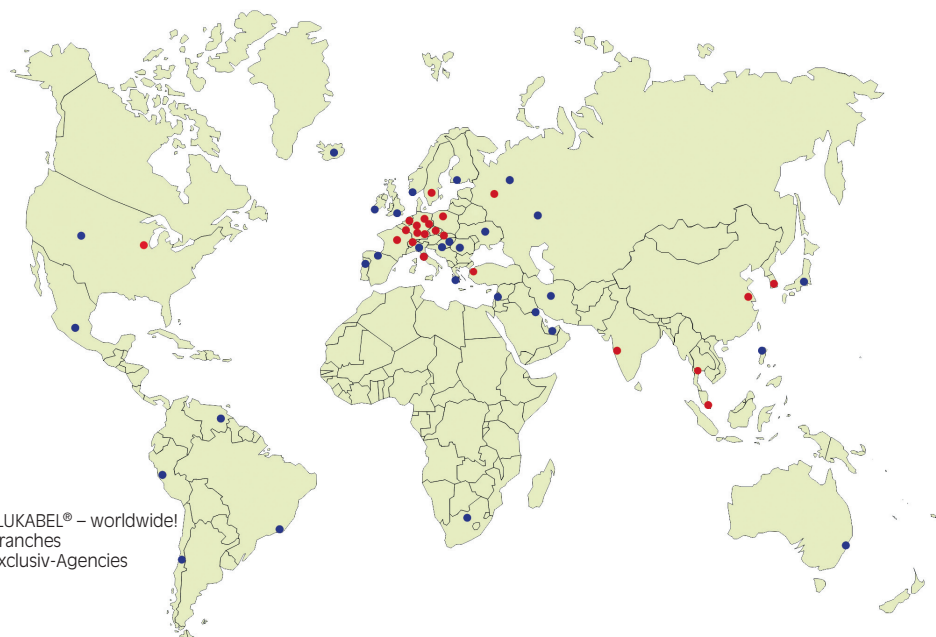

Table of contents, cable glands

Description	Page
General information	2
Installation notes	3
Plastic cable glands	5
HELUTOP® HT (polyamide)	6
HELUTOP® HT-BS (with dust protection)	7
HELUTOP® HT-K (with bent protection)	8
Counternut KMK-PA	9
Adapter PA	10
Enlarger EW-PA, Reducer RE-PA	11
Stainless steel cable glands	13
HELUTOP® HT-E (stainless steel)	14
Counternut KM-INOX (stainless steel)	15
Brass cable glands	17
HELUTOP® HT-MS (brass)	18
Counternut KM (brass)	19
Adapter (brass)	20
Enlarger EW, Reducer RE (brass)	21
Cable glands for EMC	23
Electromagnetic compatibility	24
HELUTOP® MS-EP (EMC and earthing gland)	26
Counternut KM-EMV	27
General accessories	29
Protection tabs HT	30
Multiple sealing inserts MFDE / Sealing billets	31
O-rings / Connection thread sealing rings PE	32
HELUTOP® blind plugs BL-H, BL-W	33
Approval to HELUTOP® HT	34
Contact – Germany	35
Contact – International	36
Fax inquiry	37

Our general terms and conditions of sale and payment are valid, visible at www.helukabel.de.

General information

Basic functions of a cable gland

Transferring cables and wires	<ul style="list-style-type: none">• Power (electricity)• Signals and data (current, voltage, light)
Cable protection	If a wire is to be connected in a housing, the housing must have a protective lead-through. Otherwise there is a danger that the wire will become damaged in case of movement.
Strain relief	A wire always moves to a greater or lesser extent – both during installation, and in long-term use. It is important to protect it against tensile loads. The movements may be either constant or intermittent. For this reason, a cable gland with strain relief is necessary. Strain reliefs are described in EN 50262. A distinction is made between retention, strain relief A and strain relief B. Generally, cable glands have strain relief A.
Protection classification	The lead-through in the wall of the housing must be sealed. This is described by ingress protection IP. The cable glands presented here have protection classification IP 68 – 5 bar. The 6 stands for “No dust penetration”, while the 8 stands for “Protected when permanently submerged in water” – this is tested at a water pressure of 5 bar (corresponds to 50 m water depth) for a duration of 30 min.
Seal with insert	A seal is compressed by tightening the cap nut. A particularly high quality seal and strain relief are achieved.
Sealing with clamping plates	When the cap nuts are screwed tight, lamellae press against the moulded seal – the wire is thereby sealed and the strain is relieved. The particular advantage of the clamping lamellae is that they make a large clamping range possible, to allow for different wire diameters.
Resistance	Different applications demand different degrees of resistance. Plastic cable glands made from polyamide can be used at a temperature range of between -30 °C and +80 °C. They are abrasion- and impact resistant as well as being resistant against hydrocarbons/fuels and cleaning agents. Stainless steel glands are suitable for heavy-duty use– they are waterproof and resistant to a large number of disinfectants used in food production. Brass glands are used when a long-lasting metal gland is required. Cable glands for EMC applications are also made from brass (EMC = Electro-magnetic Compatibility).
Compact design	<ul style="list-style-type: none">• No disassembly during final assembly. Simply loosening the cap nuts is sufficient.• No losing components• Quick assembly
Standard EN 50262	Cable glands are produced and tested according to the standard EN 50262. This stipulates the dimensions of the connection threads (“metric threaded connection”) as well as a series of safety-relevant parameters, e.g. strain relief. Cable glands are also available with another threaded connection (PG, NPT, etc.).
RoHS	Directive 2002/95/EC defines environment-relevant standards for electrical and electronic components and devices. This is known as RoHS for short: „Restriction of the use of certain hazardous substances in electrical and electronic equipment“. The use of heavy metals (lead, cadmium, etc.) and a number of other hazardous substances is forbidden.

Installation notes

No disassembly

Disassembly of the glands HELUTOP® are not necessary – provided that the cap nut is applied in such a way as to allow smooth running, there is no problem with subsequent insertion of the cable.

Screwing in

When screwing, observe the necessary tightening torque. If only one through-hole without thread is available, a lock nut must be used.

Protection classification

In order to achieve the desired protection classification even when working with an unfavourable surface, it may be necessary to use an O-ring or a connection thread gasket. To ensure a consistently high-quality seal, we recommend re-tightening the gland some time after assembly.

Lead through cable – turn cap nut – that's all there is to it!

Clamping ranges HELUTOP® HT

	Gland type		
	HELUTOP® HT HELUTOP® HT-BS HELUTOP® HT-E HELUTOP® HT-MS HELUTOP® MS-EP	HELUTOP® HT-R HELUTOP® HT-MS-R	HELUTOP® HT-K
Thread size	Standard	reduced sealing	with anti-kink protection
M 12x1,5	3,0 - 6,5 mm	2,0 - 5,0 mm	3,0 - 6,5 mm
M 16x1,5	4,0 - 8,0 mm	3,0 - 7,0 mm	
M 16x1,5	5,0 - 10,0 mm		5,0 - 10,0 mm
M 20x1,5	6,0 - 12,0 mm	5,0 - 9,0 mm	6,0 - 12,0 mm
M 25x1,5	11,0 - 17,0 mm	9,0 - 13,0 mm	10,0 - 14,0 mm
M 32x1,5	15,0 - 21,0 mm	11,0 - 15,0 mm	13,0 - 18,0 mm
M 40x1,5	19,0 - 28,0 mm	14,5 - 23,0 mm	
M 50x1,5	28,0 - 38,0 mm	24,0 - 31,0 mm	
M 63x1,5	34,0 - 44,0 mm	29,0 - 35,0 mm	

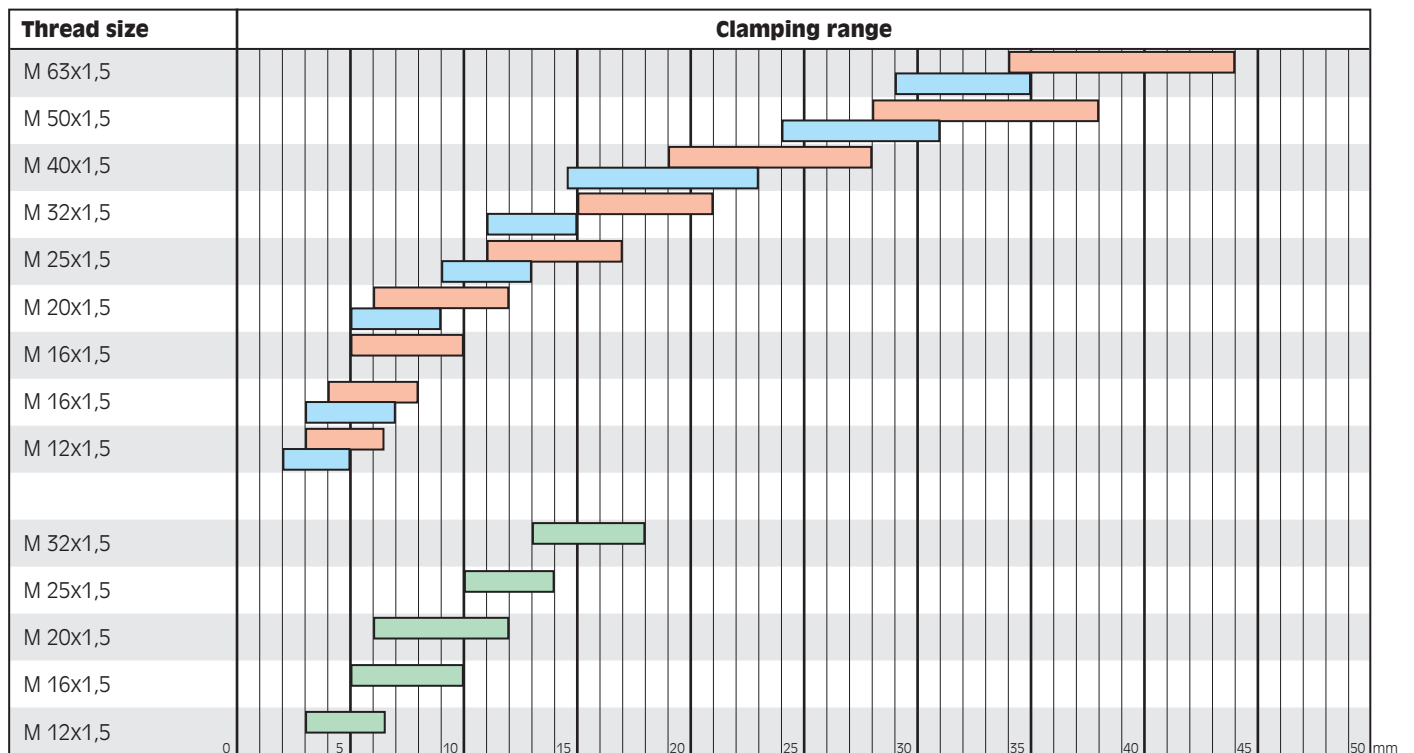



Plastic cable glands

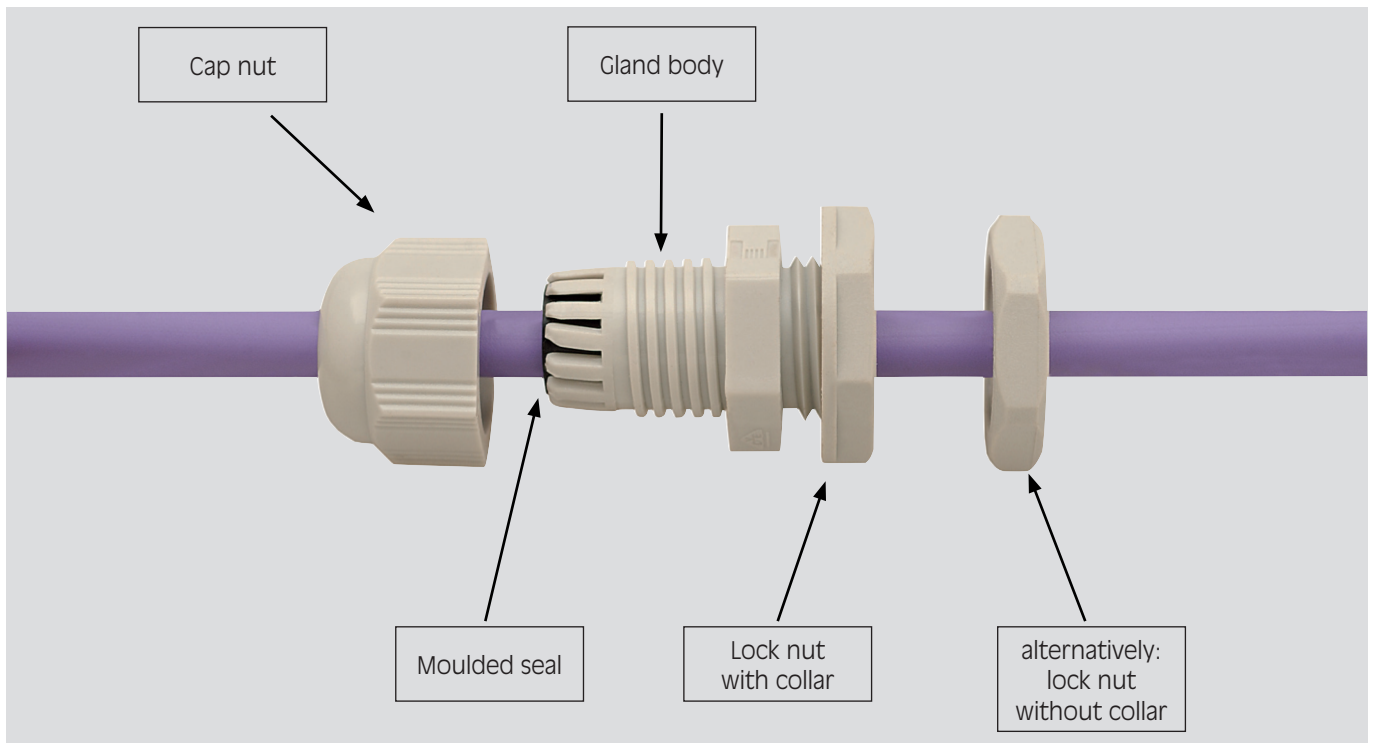

Cable gland

Cap nut and gland body are made of polyamide PA6 in the following colours:

- light grey RAL 7035
- dark grey RAL 7001
- black RAL 9005.

Polyamide PA6 is abrasion- and impact resistant, and resistant against hydrocarbons/fuels and cleaning agents. It is tried-and-tested as a material for cable glands in standard applications.

The moulded seal is made from neoprene.

The cable glands HELUTOP® HT are fitted with vibration protection for secure attachment in mobile applications.

Lock nut

The lock nuts with or without collar are made from polyamide PA6.

Accessories

Accessories suitable for use with the plastic cable glands:

- Lock nuts
- Adapters
- Enlarger
- Reducers

Accessories suitable for use with all HELUTOP® cable glands:

- Sealing plugs
- Multiple sealing inserts / lock bolts
- O-rings
- Connection thread gaskets
- Blind plates



HELUTOP® HT

The plastic cable gland with vibration protection

Properties

- Optimum strain relief through clamping plates
- Easy to assemble
- Large clamping areas

Material

- halogen-free
- phosphor-free
- silicone-free
- cadmium-free

Polyamide PA 6
UV-resistant (RAL 9005)
Seal: Neoprene

Technical data

Protection classification : IP 68 - 5 bar
Temperature range: -30°C up to +80°C
Test standard: EN50262

Note

Details on the international standards see page 34.

metric thread

Part no. light grey RAL 7035	Part no. dark grey RAL 7001	Part no. black RAL 9005	Size Metr.	Cable-Ø from / to mm	Thread length mm	Spanner size mm	Unit	net EUR/100 items at acceptance of		
								up to 100	101 - 500	501 - 1000
93908	93923	93937	M 12 x 1,5	3,0 - 6,5	8,0	15	100	o. r.	o. r.	o. r.
93909	93924	93938	M 16 x 1,5	4,0 - 8,0	8,0	19	50	o. r.	o. r.	o. r.
92667	92668	92669	M 16 x 1,5	5,0 - 10,0	10,0	22	50	o. r.	o. r.	o. r.
93910	93925	93939	M 20 x 1,5	6,0 - 12,0	10,0	24	50	o. r.	o. r.	o. r.
93911	93926	93940	M 25 x 1,5	11,0 - 17,0	8,0	29	50	o. r.	o. r.	o. r.
93912	93927	93941	M 32 x 1,5	15,0 - 21,0	10,0	36	25	o. r.	o. r.	o. r.
93913	93928	93942	M 40 x 1,5	19,0 - 28,0	10,0	46	20	o. r.	o. r.	o. r.
93914	93929	93943	M 50 x 1,5	28,0 - 38,0	18,0	60	10	o. r.	o. r.	o. r.
93915	93930	93944	M 63 x 1,5	34,0 - 44,0	18,0	65	10	o. r.	o. r.	o. r.

metric thread - with reducing seal

Part no. light grey RAL 7035	Part no. dark grey RAL 7001	Part no. black RAL 9005	Size Metr.	Cable-Ø from / to mm	Thread length mm	Spanner size mm	Unit	net EUR/100 items at acceptance of		
								up to 100	101 - 500	501 - 1000
903532	903542	903552	M 12 x 1,5	2,0 - 5,0	8,0	15	100	o. r.	o. r.	o. r.
903533	903543	903553	M 16 x 1,5	3,0 - 7,0	10,0	22	50	o. r.	o. r.	o. r.
903534	903544	903554	M 20 x 1,5	5,0 - 9,0	10,0	24	50	o. r.	o. r.	o. r.
903535	903545	903555	M 25 x 1,5	9,0 - 13,0	8,0	29	50	o. r.	o. r.	o. r.
903536	903546	903556	M 32 x 1,5	11,0 - 15,0	10,0	36	25	o. r.	o. r.	o. r.
903537	903547	903557	M 40 x 1,5	14,5 - 23,0	10,0	46	20	o. r.	o. r.	o. r.
903538	903548	903558	M 50 x 1,5	24,0 - 31,0	18,0	60	10	o. r.	o. r.	o. r.
903539	903549	903559	M 63 x 1,5	29,0 - 35,0	18,0	65	10	o. r.	o. r.	o. r.

Dimensions and specifications may be changed without prior notice

o. r. = on request

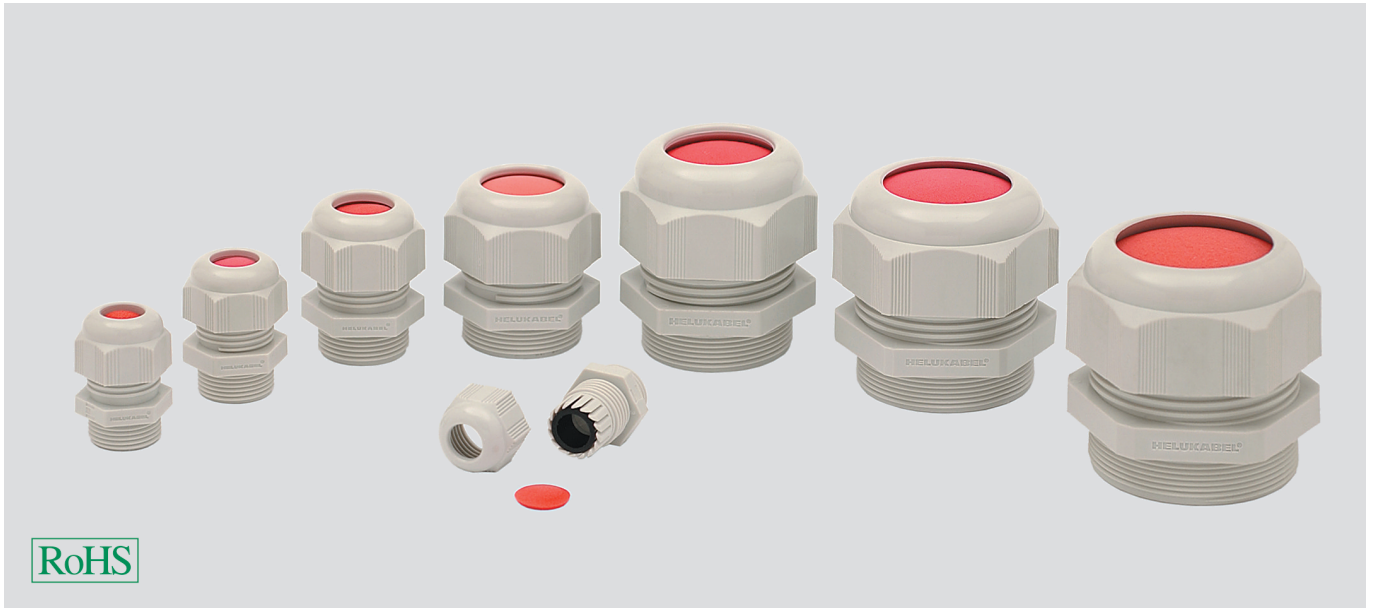

HELUTOP® HT-BS

The plastic cable gland with vibration protection and pre-assembled dust protection

Properties

- Optimum strain relief through clamping plates
- Easy to assemble
- Large clamping areas

Material

- halogen-free
- phosphor-free
- silicone-free
- cadmium-free

Polyamide PA 6
UV-resistant (RAL 9005)
Seal: Neoprene

Dust protection: foam rubber

Technical data

Protection classification : IP 68 - 5 bar
Temperature range: -30°C up to +80°C
Test standard: EN50262

Note

Details on the international standards see page 34.

Part no. light grey RAL 7035	Part no. light grey RAL 7035	Part no. dark grey RAL 7001	Size Metr.	Cable-Ø from / to mm	Thread length mm	Spanner size mm	Unit	net EUR/100 items at acceptance of		
								up to 100	101 - 500	501 - 1000
94530	94531	94541	M 16 x 1,5	5,0 - 10,0	10,0	22	50	o. r.	o. r.	o. r.
94551	94532	94542	M 20 x 1,5	6,0 - 12,0	10,0	24	50	o. r.	o. r.	o. r.
94552	94533	94543	M 25 x 1,5	11,0 - 17,0	8,0	29	50	o. r.	o. r.	o. r.
94553	94534	94544	M 32 x 1,5	15,0 - 21,0	10,0	36	25	o. r.	o. r.	o. r.
94554	94535	94545	M 40 x 1,5	19,0 - 28,0	10,0	46	20	o. r.	o. r.	o. r.
94555	94536	94546	M 50 x 1,5	28,0 - 38,0	18,0	60	10	o. r.	o. r.	o. r.
94556	94537	94547	M 63 x 1,5	34,0 - 44,0	18,0	65	10	o. r.	o. r.	o. r.

Dimensions and specifications may be changed without prior notice

o. r. = on request



HELUTOP® HT-K

With anti-kink spirals for movable, flexible lines.

Properties

- Optimum strain relief through clamping plates
- Easy to assemble

Material

- halogen-free
- phosphor-free
- silicone-free
- cadmium-free

Polyamide PA 6
 UV-resistant (RAL 9005)
 Seal: Neoprene

Technical data

Protection classification : IP 68 - 5 bar
 Temperature range: -30°C up to +80°C
 Test standard: EN50262

Note

Details on the international standards see page 34.

Part no. light grey RAL 7035	Part no. dark grey RAL 7001	Part no. black RAL 9005	Size Metr.	Cable-Ø from / to mm	Thread length mm	Spanner size mm	Unit	net EUR/100 items at acceptance of		
								up to 100	101 - 500	501 - 1000
93867	93856	93878	M 12 x 1,5	3,0 - 6,5	8,0	15	50	o. r.	o. r.	o. r.
93868	93857	93879	M 16 x 1,5	5,0 - 10,0	10,0	22	50	o. r.	o. r.	o. r.
93869	93858	93880	M 20 x 1,5	6,0 - 12,0	10,0	24	50	o. r.	o. r.	o. r.
93870	93859	93881	M 20 x 1,5	10,0 - 14,0	10,0	27	25	o. r.	o. r.	o. r.
93871	93860	93882	M 25 x 1,5	13,0 - 18,0	10,0	33	20	o. r.	o. r.	o. r.

Dimensions and specifications may be changed without prior notice

o. r. = on request

Counternut KMK-PA

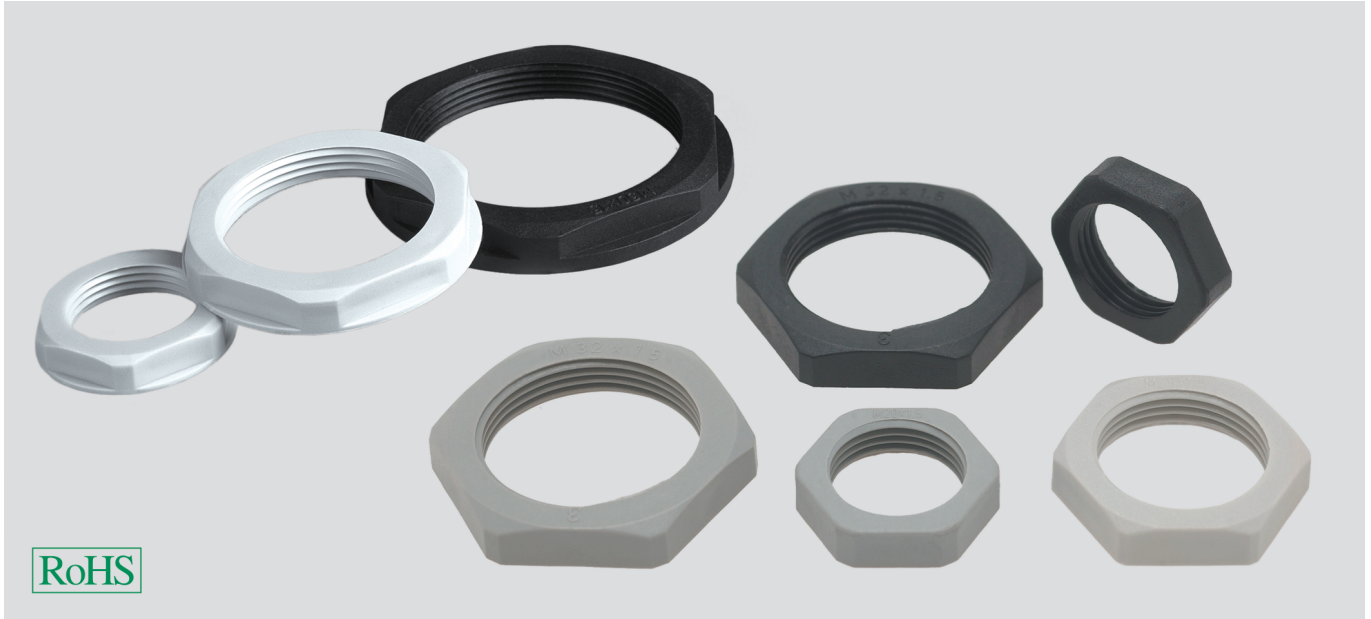

KMK-PA MB

The counternut made of polyamide.
The counternut with collar has a bigger sealing area - sealing with an additional O-ring will be simplified.

Material

- halogen-free
- silicone-free
- phosphor-free
- cadmium-free

Polyamide PA 6
UV-resistant (RAL 9005)

Technical data

Temperature range: -40°C up to +100°C

KMK-PA-MB

Counternut with collar

Part no. light grey RAL 7035	Part no. dark grey RAL 7001	Part no. black RAL 9005	Size Metr.	Thread length mm	Unit	net EUR/100 items at acceptance of		
						up to 100	101 - 500	501 - 1000
97816	94260	98163	M 12 x 1,5	18	100	o. r.	o. r.	o. r.
97817	94261	98164	M 16 x 1,5	22	100	o. r.	o. r.	o. r.
97818	94262	98165	M 20 x 1,5	26	100	o. r.	o. r.	o. r.
97819	94263	98166	M 25 x 1,5	32	100	o. r.	o. r.	o. r.
97820	94264	98167	M 32 x 1,5	41	100	o. r.	o. r.	o. r.
97821	94265	98168	M 40 x 1,5	50	50	o. r.	o. r.	o. r.
97822	94266	98169	M 50 x 1,5	60	50	o. r.	o. r.	o. r.
97823	94267	98170	M 63 x 1,5	75	25	o. r.	o. r.	o. r.

KMK-PA-OB

Counternut without collar

Part no. light grey RAL 7035	Part no. dark grey RAL	Part no. black RAL 9005	Size Metr.	Thread length mm	Unit	net EUR/100 items at acceptance of		
						up to 100	101 - 500	501 - 1000
94630	94640	94650	M 12 x 1,5	18	100	o. r.	o. r.	o. r.
94631	94641	94651	M 16 x 1,5	22	100	o. r.	o. r.	o. r.
94632	94642	94652	M 20 x 1,5	26	100	o. r.	o. r.	o. r.
94633	94643	94653	M 25 x 1,5	32	100	o. r.	o. r.	o. r.
94634	94644	94654	M 32 x 1,5	41	100	o. r.	o. r.	o. r.
94635	94645	94655	M 40 x 1,5	50	50	o. r.	o. r.	o. r.
94636	94646	94656	M 50 x 1,5	60	50	o. r.	o. r.	o. r.
94637	94647	94657	M 63 x 1,5	75	25	o. r.	o. r.	o. r.

Dimensions and specifications may be changed without prior notice

o. r. = on request

Adapter PA



Adapter PA

The adapter made of polyamide for solving problems when converting from PG to metric.

Material

- halogen-free
- silicone-free
- phosphor-free
- cadmium-free

Polyamide

Colours: light grey
RAL: 7035

Technical data

Temperature range: -40°C up to +100°C

Part no.	Size PG outer	Size metric inner	Unit	net EUR/100 items at acceptance of		
				up to 100	101 - 500	501 - 1000
93650	7	M 12 x 1,5	100	o. r.	o. r.	o. r.
93651	7	M 16 x 1,5	100	o. r.	o. r.	o. r.
93652	9	M 12 x 1,5	100	o. r.	o. r.	o. r.
93653	9	M 16 x 1,5	100	o. r.	o. r.	o. r.
93654	9	M 20 x 1,5	100	o. r.	o. r.	o. r.
93655	11	M 16 x 1,5	100	o. r.	o. r.	o. r.
93656	11	M 20 x 1,5	100	o. r.	o. r.	o. r.
93657	13,5	M 16 x 1,5	100	o. r.	o. r.	o. r.
93658	13,5	M 20 x 1,5	100	o. r.	o. r.	o. r.
93659	13,5	M 25 x 1,5	100	o. r.	o. r.	o. r.
93660	16	M 20 x 1,5	100	o. r.	o. r.	o. r.
93661	16	M 25 x 1,5	100	o. r.	o. r.	o. r.
93662	21	M 25 x 1,5	50	o. r.	o. r.	o. r.
93663	21	M 32 x 1,5	50	o. r.	o. r.	o. r.
93664	29	M 32 x 1,5	50	o. r.	o. r.	o. r.
93665	29	M 40 x 1,5	50	o. r.	o. r.	o. r.

Dimensions and specifications may be changed without prior notice

o. r. = on request

Enlargement EW-PA, Reducer RE-PA



EW-PA

The extender made of polyamide.
Transition from small to large thread.

Material

- halogen-free
- phosphor-free
- silicone-free
- cadmium-free

Polyamide

Colours: light grey
RAL: 7035

Technical data

Temperature range: -40°C up to +100°C

Part no.	Size metric outer	Size metric inner	Unit	net EUR/100 items at acceptance of		
				up to 100	101 - 500	501 - 1000
98585	M 12 x 1,5	M 16 x 1,5	100	o. r.	o. r.	o. r.
98586	M 16 x 1,5	M 20 x 1,5	100	o. r.	o. r.	o. r.
95099	M 20 x 1,5	M 25 x 1,5	100	o. r.	o. r.	o. r.
98587	M 25 x 1,5	M 32 x 1,5	50	o. r.	o. r.	o. r.
98588	M 32 x 1,5	M 40 x 1,5	50	o. r.	o. r.	o. r.
98589	M 40 x 1,5	M 50 x 1,5	25	o. r.	o. r.	o. r.

RE PA

The reducer made of polyamide.
Transition from large to small thread.

Material

- halogen-free
- phosphor-free
- silicone-free

Polyamide

Colours: light grey
RAL: 7035

Technical data

Temperature range: -30°C up to +100°C

Part no.	Size metric outer	Size metric inner	Unit	net EUR/100 items at acceptance of		
				up to 100	101 - 500	501 - 1000
97829	M 20 x 1,5	M 12 x 1,5	100	o. r.	o. r.	o. r.
97830	M 20 x 1,5	M 16 x 1,5	100	o. r.	o. r.	o. r.
97831	M 25 x 1,5	M 12 x 1,5	100	o. r.	o. r.	o. r.
97832	M 25 x 1,5	M 16 x 1,5	100	o. r.	o. r.	o. r.
97833	M 25 x 1,5	M 20 x 1,5	100	o. r.	o. r.	o. r.
97834	M 32 x 1,5	M 12 x 1,5	50	o. r.	o. r.	o. r.
97835	M 32 x 1,5	M 16 x 1,5	50	o. r.	o. r.	o. r.
97836	M 32 x 1,5	M 20 x 1,5	50	o. r.	o. r.	o. r.
97837	M 32 x 1,5	M 25 x 1,5	50	o. r.	o. r.	o. r.
97838	M 40 x 1,5	M 16 x 1,5	50	o. r.	o. r.	o. r.
97839	M 40 x 1,5	M 20 x 1,5	50	o. r.	o. r.	o. r.
97840	M 40 x 1,5	M 25 x 1,5	50	o. r.	o. r.	o. r.
97841	M 40 x 1,5	M 32 x 1,5	50	o. r.	o. r.	o. r.
97842	M 50 x 1,5	M 20 x 1,5	25	o. r.	o. r.	o. r.
97843	M 50 x 1,5	M 25 x 1,5	25	o. r.	o. r.	o. r.
97844	M 50 x 1,5	M 32 x 1,5	25	o. r.	o. r.	o. r.
97845	M 50 x 1,5	M 40 x 1,5	25	o. r.	o. r.	o. r.
97846	M 63 x 1,5	M 25 x 1,5	25	o. r.	o. r.	o. r.
97847	M 63 x 1,5	M 32 x 1,5	25	o. r.	o. r.	o. r.
97848	M 63 x 1,5	M 40 x 1,5	25	o. r.	o. r.	o. r.
97849	M 63 x 1,5	M 50 x 1,5	25	o. r.	o. r.	o. r.

Dimensions and specifications may be changed without prior notice



Stainless steel cable glands

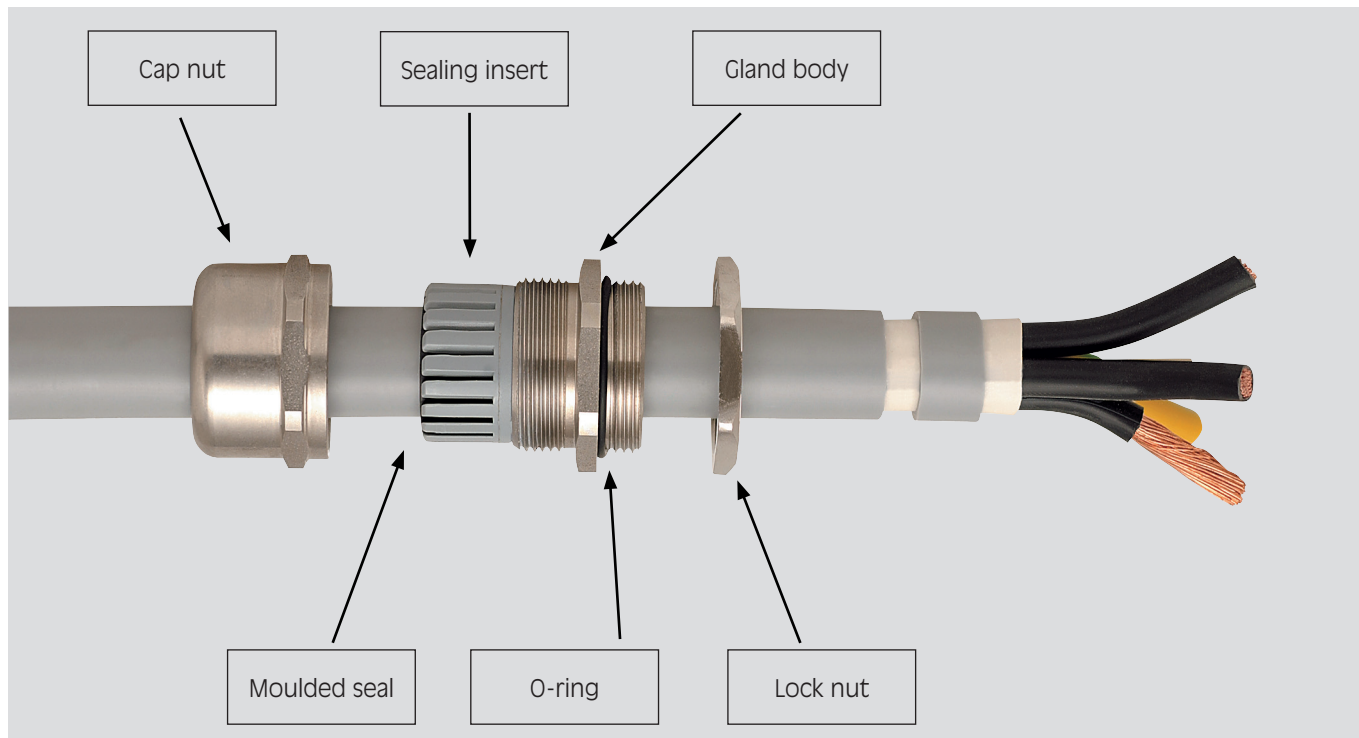

Cable gland

Cap nut and gland body are made from stainless steel. Due to their high degree of corrosion resistance and longevity, these glands are suitable for tough conditions:

- Heavy chemical loads
- Cleaning agents (e.g. in the food industry)
- Weather-resistant when used outdoors.

The terminal insert is made from polyamide PA6.

The moulded seal is made from neoprene.

The O-ring is made from Buna-N

Lock nut

The lock nuts are made from stainless steel.

Accessories

Accessories suitable for use with the stainless steel cable glands:

- Lock nuts

Accessories suitable for use with all cable glands:

- Sealing plugs
- Multiple sealing inserts / lock bolts
- O-rings
- Connection thread gaskets
- Blind plates



HELUTOP® HT-E

The stainless steel cable gland for heavy load

Properties

- Optimum strain relief through clamping plates
- Highly corrosion-resistant
- Highly durable
- Easy to assemble
- Large clamping areas

Material

Stainless steel 1.4305
 Clamp: Polyamide PA 6
 Seal: Neoprene
 O-ring: Buna-N

Technical data

Protection classification : IP 68 - 5 bar
 Temperature range: -40°C up to +100°C
 Test standard: EN50262

Note

Details on the international standards see page 34.

Part no.	Size Metr.	Cable-Ø from / to mm	Thread length mm	Spanner size mm	Unit	net EUR/100 Items at acceptance of		
						up to 100	101 - 500	501 - 1000
99980	M 12 x 1,5	3,0 - 6,5	6,0	14	50	o. r.	o. r.	o. r.
99981	M 16 x 1,5	5,0 - 10,0	7,0	20	50	o. r.	o. r.	o. r.
99982	M 20 x 1,5	6,0 - 12,0	8,0	22	50	o. r.	o. r.	o. r.
99983	M 25 x 1,5	11,0 - 17,0	8,0	27	25	o. r.	o. r.	o. r.
99984	M 32 x 1,5	15,0 - 21,0	8,0	34	20	o. r.	o. r.	o. r.
99985	M 40 x 1,5	19,0 - 28,0	9,0	43	10	o. r.	o. r.	o. r.
99986	M 50 x 1,5	28,0 - 38,0	9,0	58	5	o. r.	o. r.	o. r.
99987	M 63 x 1,5	34,0 - 44,0	14,0	64/68	5	o. r.	o. r.	o. r.

Dimensions and specifications may be changed without prior notice

o. r. = on request

Counternut KM-INOX (stainless steel)

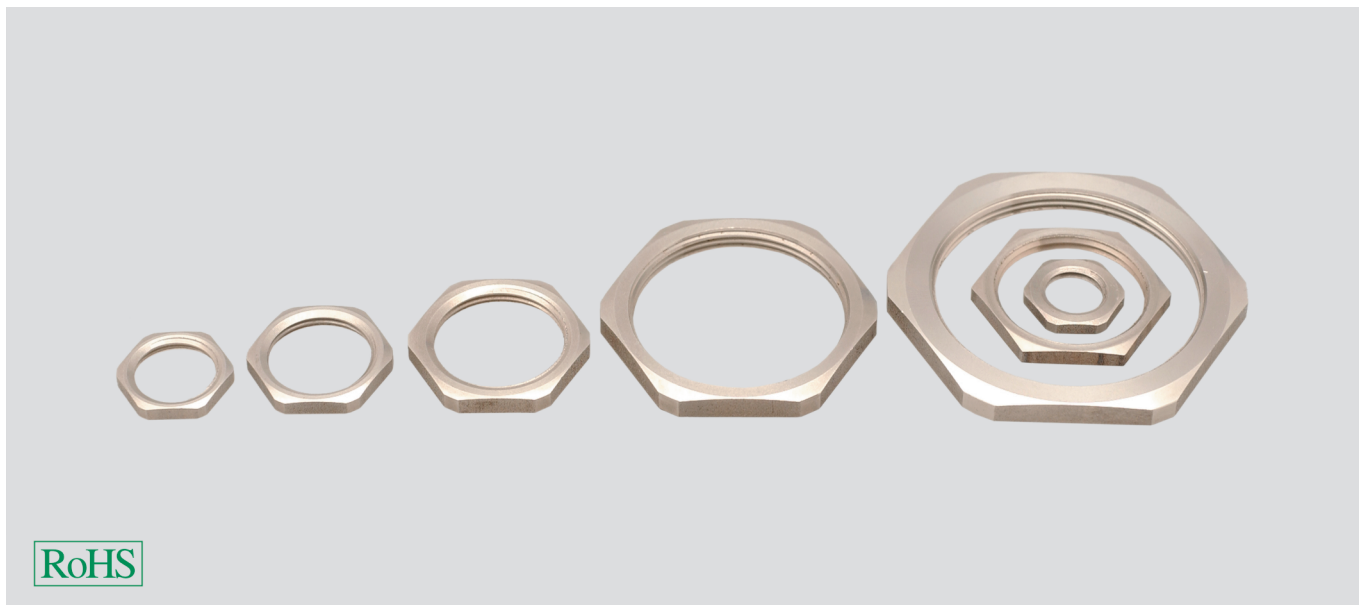

KM INOX

The counternut made of stainless steel.

Material

Stainless steel 1.4305

Technical data

Temperature range: up to +200°C

KM INOX

Counternut made of stainless steel

Part no.	Size Metr.	Thread length mm	Unit	net EUR/100 items at acceptance of		
				up to 100	101 - 500	501 - 1000
920605	M 12 x 1,5	15	50	o. r.	o. r.	o. r.
920606	M 16 x 1,5	19	50	o. r.	o. r.	o. r.
920607	M 20 x 1,5	24	50	o. r.	o. r.	o. r.
920608	M 25 x 1,5	30	50	o. r.	o. r.	o. r.
920609	M 32 x 1,5	36	50	o. r.	o. r.	o. r.
920610	M 40 x 1,5	46	25	o. r.	o. r.	o. r.
920611	M 50 x 1,5	60	25	o. r.	o. r.	o. r.
920612	M 63 x 1,5	70	10	o. r.	o. r.	o. r.

Dimensions and specifications may be changed without prior notice

o. r. = on request



Brass cable glands

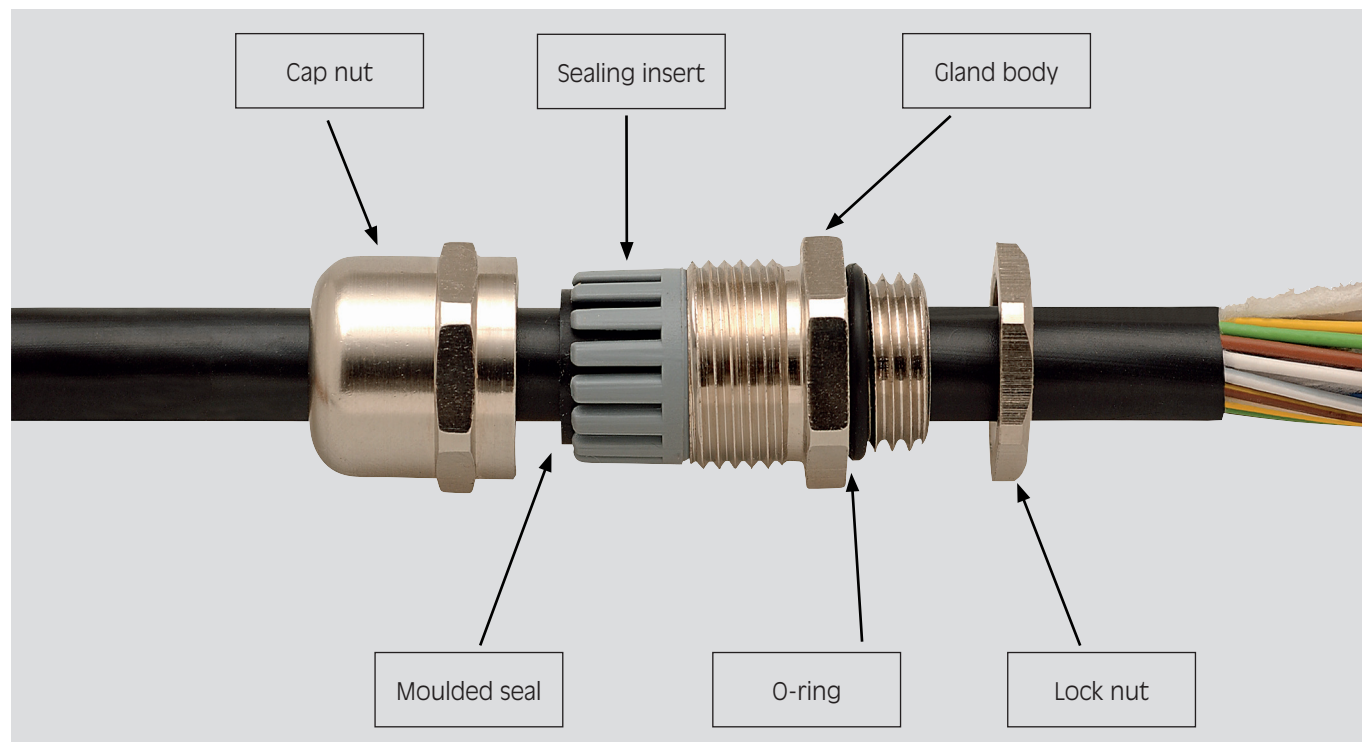

Cable gland

Cap nut and gland body are made from nickel-plated brass. These glands are used for those standard applications where metal glands are needed.

The terminal insert is made from polyamide PA6.

The moulded seal is made from neoprene.

The O-ring is made from Buna-N.

Lock nut

The lock nuts are made from nickel-plated brass.

Accessories

Accessories suitable for use with the brass cable glands:

- Lock nuts
- Adapters
- Enlarger
- Reducers

Accessories suitable for use with all cable glands:

- Sealing plugs
- Multiple sealing inserts / lock bolts
- O-rings
- Connection thread gaskets
- Blind plates



HELUTOP® HT-MS

The nickel-coated brass cable gland.

Properties

- Optimum strain relief through clamping plates
- Easy to assemble
- Large clamping areas

Material

Brass, nickel plated
 Clamp: Polyamide PA 6
 Seal: Neoprene
 O-ring: Buna-N

Technical data

Protection classification : IP 68 - 5 bar
 Temperature range: -40°C up to +100°C
 Test standard: EN50262

Note

Details on the international standards see page 34.

metric thread

Part no.	Size Metr.	Cable-Ø from / to mm	Thread length mm	Spanner size mm	Unit	net EUR/100 items at acceptance of		
						up to 100	101 - 500	501 - 1000
90760	M 12 x 1,5	3,0 - 6,5	6,0	14	50	o. r.	o. r.	o. r.
99960	M 16 x 1,5	5,0 - 10,0	7,0	20	50	o. r.	o. r.	o. r.
90762	M 20 x 1,5	6,0 - 12,0	8,0	22	50	o. r.	o. r.	o. r.
99961	M 25 x 1,5	11,0 - 17,0	8,0	27	25	o. r.	o. r.	o. r.
94624	M 32 x 1,5	15,0 - 21,0	8,0	34	20	o. r.	o. r.	o. r.
99962	M 40 x 1,5	19,0 - 28,0	9,0	43	10	o. r.	o. r.	o. r.
99963	M 50 x 1,5	28,0 - 38,0	9,0	58	5	o. r.	o. r.	o. r.
90767	M 63 x 1,5	34,0 - 44,0	14,0	64/68	5	o. r.	o. r.	o. r.

metric thread - with reduced seal insert

Part no.	Size Metr.	Cable-Ø from / to mm	Thread length mm	Spanner size mm	Unit	net EUR/100 items at acceptance of		
						up to 100	101 - 500	501 - 1000
903560	M 12 x 1,5	2,0 - 5,0	6,0	14	50	o. r.	o. r.	o. r.
903561	M 16 x 1,5	3,0 - 7,0	7,0	20	50	o. r.	o. r.	o. r.
903562	M 20 x 1,5	5,0 - 9,0	8,0	22	50	o. r.	o. r.	o. r.
903563	M 25 x 1,5	9,0 - 13,0	8,0	27	25	o. r.	o. r.	o. r.
903564	M 32 x 1,5	11,0 - 15,5	8,0	34	20	o. r.	o. r.	o. r.
903565	M 40 x 1,5	14,5 - 23,0	9,0	43	10	o. r.	o. r.	o. r.
903566	M 50 x 1,5	24,0 - 31,0	9,0	58	5	o. r.	o. r.	o. r.
903567	M 63 x 1,5	29,0 - 35,0	14,0	64/68	5	o. r.	o. r.	o. r.

Dimensions and specifications may be changed without prior notice

o. r. = on request

Counternut KM (brass)



KM

The counternut from nickel-coated brass.

Material

Brass, nickel plated

Technical data

Temperature range: up to +200°C

KM

Counternut made of nickel-coated brass

Part no.	Size Metr.	Thread length mm	Unit	net EUR/100 items at acceptance of		
				up to 100	101 - 500	501 - 1000
90175	M 12 x 1,5	15	100	o. r.	o. r.	o. r.
90176	M 16 x 1,5	19	100	o. r.	o. r.	o. r.
90177	M 20 x 1,5	24	100	o. r.	o. r.	o. r.
90178	M 25 x 1,5	30	100	o. r.	o. r.	o. r.
90179	M 32 x 1,5	36	100	o. r.	o. r.	o. r.
90180	M 40 x 1,5	46	50	o. r.	o. r.	o. r.
90181	M 50 x 1,5	60	25	o. r.	o. r.	o. r.
90182	M 63 x 1,5	70	10	o. r.	o. r.	o. r.

Dimensions and specifications may be changed without prior notice

o. r. = on request

Adapter (brass)



Adapter hexagonal, brass

Hexagonal adapters made by brass for solving the transition from PG to metric thread.

Material

Brass, nickel plated

Technical data

Temperature range: up to +200°C

hexagonal

Part no.	Size PG outer	Size metric inner	Unit	net EUR/100 items at acceptance of		
				up to 100	101 - 500	501 - 1000
904327	13,5	M 16 x 1,5	100	o. r.	o. r.	o. r.
904328	16	M 20 x 1,5	50	o. r.	o. r.	o. r.
904329	21	M 25 x 1,5	50	o. r.	o. r.	o. r.
904330	29	M 32 x 1,5	25	o. r.	o. r.	o. r.
904331	36	M 40 x 1,5	10	o. r.	o. r.	o. r.

hexagonal - high-profile design

Part no.	Size PG outer	Size metric inner	Unit	net EUR/100 items at acceptance of		
				up to 100	101 - 500	501 - 1000
904332	7	M 12 x 1,5	100	o. r.	o. r.	o. r.
904333	9	M 16 x 1,5	100	o. r.	o. r.	o. r.
904334	11	M 16 x 1,5	100	o. r.	o. r.	o. r.
904335	13,5	M 20 x 1,5	100	o. r.	o. r.	o. r.
904336	16	M 20 x 1,5	50	o. r.	o. r.	o. r.
904337	16	M 25 x 1,5	50	o. r.	o. r.	o. r.
904338	21	M 25 x 1,5	50	o. r.	o. r.	o. r.
904339	21	M 32 x 1,5	50	o. r.	o. r.	o. r.
904340	29	M 40 x 1,5	25	o. r.	o. r.	o. r.
904341	36	M 50 x 1,5	10	o. r.	o. r.	o. r.
904342	42	M 63 x 1,5	5	o. r.	o. r.	o. r.

round

Part no.	Size PG outer	Size metric inner	Unit	net EUR/100 items at acceptance of		
				up to 100	101 - 500	501 - 1000
904374	11	M 20 x 1,5	100	o. r.	o. r.	o. r.
904375	13,5	M 20 x 1,5	100	o. r.	o. r.	o. r.

round - high-profile design

Part no.	Size PG outer	Size metric inner	Unit	net EUR/100 items at acceptance of		
				up to 100	101 - 500	501 - 1000
904376	9	M 16 x 1,5	100	o. r.	o. r.	o. r.
904377	11	M 20 x 1,5	100	o. r.	o. r.	o. r.
904378	13,5	M 20 x 1,5	100	o. r.	o. r.	o. r.
904379	16	M 25 x 1,5	50	o. r.	o. r.	o. r.

Dimensions and specifications may be changed without prior notice

o. r. = on request

Enlarger EW, Reducer RE (brass)



EW

The extender made of brass. Transition from small to large thread.

Material

Brass, nickel plated

Technical data

Temperature range: up to +200°C

round

Part no.	Size metric outer	Size metric inner	Unit	net EUR/100 items at acceptance of		
				up to 100	101 - 500	501 - 1000
94064	M 12 x 1,5	M 16 x 1,5	50	o. r.	o. r.	o. r.
94066	M 16 x 1,5	M 20 x 1,5	50	o. r.	o. r.	o. r.
94069	M 20 x 1,5	M 25 x 1,5	50	o. r.	o. r.	o. r.
94072	M 25 x 1,5	M 32 x 1,5	50	o. r.	o. r.	o. r.
94075	M 32 x 1,5	M 40 x 1,5	50	o. r.	o. r.	o. r.
94078	M 40 x 1,5	M 50 x 1,5	25	o. r.	o. r.	o. r.
94081	M 50 x 1,5	M 63 x 1,5	10	o. r.	o. r.	o. r.

RE

The reducer made of brass. Transition from large to small thread.

Material

Brass, nickel plated

Technical data

Temperature range: up to +200°C

hexagonal

Part no.	Size metric outer	Size metric inner	Unit	net EUR/100 items at acceptance of		
				up to 100	101 - 500	501 - 1000
904380	M 16 x 1,5	M 12 x 1,5	100	o. r.	o. r.	o. r.
904381	M 20 x 1,5	M 12 x 1,5	100	o. r.	o. r.	o. r.
904382	M 20 x 1,5	M 16 x 1,5	100	o. r.	o. r.	o. r.
904383	M 25 x 1,5	M 16 x 1,5	100	o. r.	o. r.	o. r.
904384	M 25 x 1,5	M 20 x 1,5	100	o. r.	o. r.	o. r.
94073	M 32 x 1,5	M 20 x 1,5	25	o. r.	o. r.	o. r.
94946	M 32 x 1,5	M 25 x 1,5	50	o. r.	o. r.	o. r.
94076	M 40 x 1,5	M 25 x 1,5	25	o. r.	o. r.	o. r.
90909	M 40 x 1,5	M 32 x 1,5	25	o. r.	o. r.	o. r.
904385	M 50 x 1,5	M 32 x 1,5	10	o. r.	o. r.	o. r.
90865	M 50 x 1,5	M 40 x 1,5	10	o. r.	o. r.	o. r.
94947	M 63 x 1,5	M 40 x 1,5	5	o. r.	o. r.	o. r.
904386	M 63 x 1,5	M 50 x 1,5	5	o. r.	o. r.	o. r.

round

Part no.	Size metric outer	Size metric inner	Unit	net EUR/100 items at acceptance of		
				up to 100	101 - 500	501 - 1000
94065	M 16 x 1,5	M 12 x 1,5	100	o. r.	o. r.	o. r.
94067	M 20 x 1,5	M 12 x 1,5	100	o. r.	o. r.	o. r.
94068	M 20 x 1,5	M 16 x 1,5	100	o. r.	o. r.	o. r.
94070	M 25 x 1,5	M 16 x 1,5	100	o. r.	o. r.	o. r.
904407	M 25 x 1,5	M 20 x 1,5	100	o. r.	o. r.	o. r.
904408	M 32 x 1,5	M 20 x 1,5	50	o. r.	o. r.	o. r.
94074	M 32 x 1,5	M 25 x 1,5	50	o. r.	o. r.	o. r.
904409	M 40 x 1,5	M 25 x 1,5	10	o. r.	o. r.	o. r.
94077	M 40 x 1,5	M 32 x 1,5	10	o. r.	o. r.	o. r.
94079	M 50 x 1,5	M 32 x 1,5	10	o. r.	o. r.	o. r.
94080	M 50 x 1,5	M 40 x 1,5	10	o. r.	o. r.	o. r.
94082	M 63 x 1,5	M 40 x 1,5	10	o. r.	o. r.	o. r.
94083	M 63 x 1,5	M 50 x 1,5	10	o. r.	o. r.	o. r.

Dimensions and specifications may be changed without prior notice

o. r. = on request



Cable glands for electromagnetic compatibility (EMC)

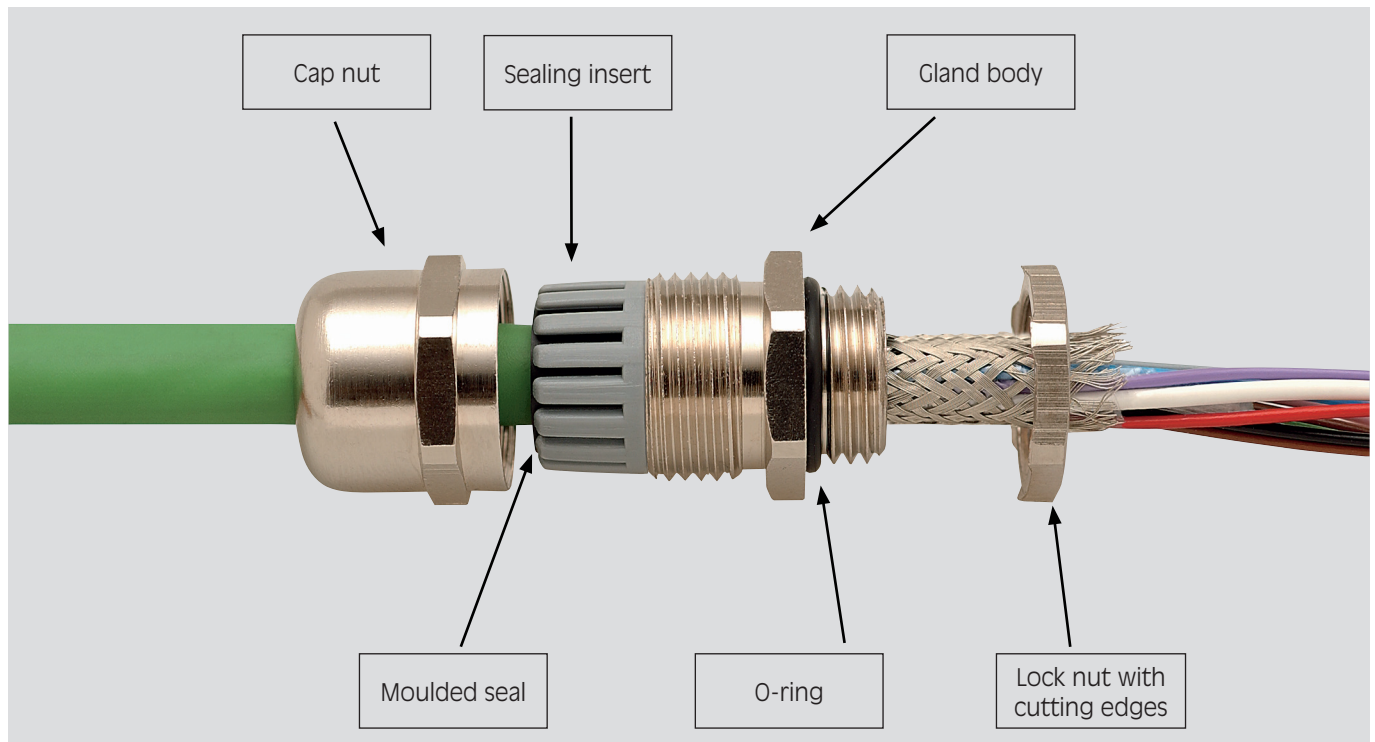

Cable gland

These cable glands are used in high-quality EMC applications.

Cap nut and gland body are made from nickel-plated brass.

The contact springs form a safe and reliable contact with the screened braiding of the cable. They are made from copper-beryllium – this material ensures a good conductivity and a strong spring force in the long term. The spring ring is movable prior to the cap nut being tightened – damage to the screened braiding during assembly is thus prevented.

The terminal insert is made from polyamide PA6.

The moulded seal is made from neoprene.

The O-ring is made from Buna-N.

Lock nut

The lock nuts are made from nickel-plated brass. They have cutting edges for cutting through coated surfaces.

Accessories

Accessories suitable for use with the brass cable glands:

- Lock nuts

Accessories suitable for use with all cable glands:

- Sealing plugs
- O-rings
- Connection thread gaskets
- Blind plates

Electromagnetic compatibility

The subject of electromagnetic compatibility covers everything connected with intentional and unintentional malfunctions in electrical operating materials caused by electrical, magnetic or electromagnetic fields and processes.

Technically, a distinction is made between “conducted” and “non-conducted” faults:

Conducted faults are transferred directly from the source of the fault to the sink via feeder or signal lines.

Non-conducted faults are coupled with the sink by means of an electromagnetic field, i.e. as electromagnetic radiation, and are received there by a wire functioning as an antenna.

Faults should not occur

In the European **EMC Directive**, electromagnetic compatibility is defined as follows:

The ability of a device, unit of equipment or system to function satisfactorily in its electromagnetic environment without introducing intolerable electromagnetic disturbances to any device, unit of equipment or system in that environment.

The energy supply companies and the EU legislator require that manufacturers of electrical devices adhere to appropriate “protection requirements”.

In Germany, the Electromagnetic Compatibility Act applies. The EMC Directive is generally applied in conjunction with the Low Voltage Directive.

Important components for preventing faults

Screened cables:

The screen over the inner sheath of the cable is designed to keep out external disturbances and keep in internally-generated disturbances.

Sheet shielding or

Screened braiding – a coverage of more than 85% is considered necessary.

Electromagnetic compatibility

EMC glands:

The screen of the cable is contacted with the housing of the control / motor via appropriate cable glands.

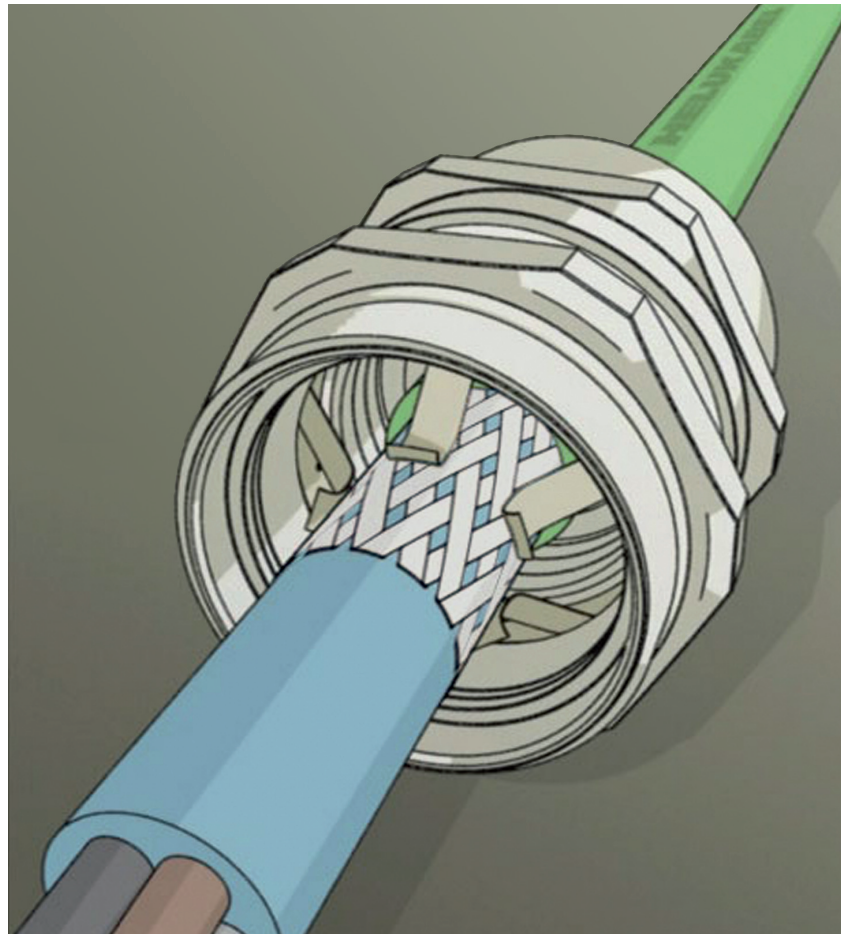

If the screen is applied at both ends, then one has the additional benefit of potential equalisation at both ends, and effective screening. Here it should be ensured that the two grounds are not different, otherwise a flow of disturbing equalising currents could occur.

The contact in the gland is generally created by means of a contact spring. This gives a good contact but also allows rapid assembly. Our HELUTOP® MS-EP has a simultaneously-rotating spring ring. Provided that the cable is not yet fixed, it is still possible to turn the cable in the gland. Only when it is fixed by turning the cap nut is the screen contact also finally fixed.

Most important accessories: Lock nut with cutting edges. Painted, anodised or contaminated surfaces are cut through by the cutting edges and the contact between the cable gland and the housing is thereby securely made.



HELUTOP® MS-EP

The EMC- and earthing gland with integrated contact system for safe, quick assembly and contacting.

Properties

- Optimum strain relief through clamping plates
- No damage of shield during assembly or disassembly by moving contact ring.
- Contact made automatically when the gland is closed
- Excellent shield damping and current deflection
- High savings achieved in time and assembly costs

Material

Brass, nickel plated
 Contact system: Copper-Beryllium
 Clamp: Polyamide PA 6
 Seal: Neoprene

Technical data

Protection classification : IP 68 - 5 bar
 Temperature range: -40°C up to +100°C
 Test standard: EN50262
 Contact system: patented

Note

Details on the international standards see page 34.

Part no.	Size Metr.	Cable-Ø from / to mm	Thread length mm	Spanner size mm	Unit	net EUR/100 items at acceptance of		
						up to 100	101 - 500	501 - 1000
99950	M 12 x 1,5	3,0 - 6,5	6,0	14	50	o. r.	o. r.	o. r.
99951	M 16 x 1,5	5,0 - 10,0	7,0	20	50	o. r.	o. r.	o. r.
99952	M 20 x 1,5	6,0 - 12,0	8,0	22	50	o. r.	o. r.	o. r.
99953	M 25 x 1,5	11,0 - 17,0	8,0	27	25	o. r.	o. r.	o. r.
99954	M 32 x 1,5	15,0 - 21,0	8,0	34	20	o. r.	o. r.	o. r.
99955	M 40 x 1,5	19,0 - 28,0	9,0	43	10	o. r.	o. r.	o. r.
99956	M 50 x 1,5	28,0 - 38,0	9,0	58	5	o. r.	o. r.	o. r.
99957	M 63 x 1,5	34,0 - 44,0	14,0	64/68	5	o. r.	o. r.	o. r.

Dimensions and specifications may be changed without prior notice

o. r. = on request

Counternut KM-EMV



KM-EMV

- The counternut with cutting edges for secure fixing of EMC cable glands
- for cutting through painted surfaces to ensure optimum contact with equipotential bonding
- increased vibration resistance.

Material

Brass, nickel coated

Technical data

Temperature range: up to +200°C

Part no.	Size Metr.	Thread length mm	Unit	net EUR/100 items at acceptance of		
				up to 100	101 - 500	501 - 1000
90165	M 12 x 1,5	15	100	o. r.	o. r.	o. r.
90166	M 16 x 1,5	19	100	o. r.	o. r.	o. r.
90167	M 20 x 1,5	24	100	o. r.	o. r.	o. r.
90168	M 25 x 1,5	30	100	o. r.	o. r.	o. r.
90169	M 32 x 1,5	36	100	o. r.	o. r.	o. r.
90170	M 40 x 1,5	46	50	o. r.	o. r.	o. r.
90171	M 50 x 1,5	60	25	o. r.	o. r.	o. r.
90172	M 63 x 1,5	70	10	o. r.	o. r.	o. r.

Dimensions and specifications may be changed without prior notice

o. r. = on request



Accessories for cable glands

Accessories suitable to the various materials/applications:

	Cable gland types made from			
	Plastic	Stainless steel	Brass	Brass for EMC
Lock nut	KMK-PA-MB, with collar KMK-PA-OB, without collar, page 9	KM-INOX page 15	KM page 19	KM-EMV page 27
Adapter	Adapter PA page 10	-	Adapter, brass page 20	(non-typical: adapter, brass)
Enlarger	EW-PA page 11	-	EW page 21	(non-typical: EW)
Reducer	RE-PA page 11	-	RE page 21	(non-typical: RE)

Accessories suitable for use with all HELUTOP® cable glands:

	Cable gland types made from			
	Plastic	Stainless steel	Brass	Brass for EMC
Sealing plug	Sealing plug HT page 31			
Multiple sealing insert / lock bolt	HT-MFDE lock bolt page 31			(non-typical)
O-Ring	O-Ring page 32			
Threaded connection gasket	AGDR-PE page 32			
Blind plate	BL-H, hard BL-W, soft page 33			

Protection tabs HT



HELUTOP® HT protection tab

Protection tab HT for sealing of empty cable glands HELUTOP® HT

Material

Polyamide
UV-resistant (RAL 9005)

Colours: black

Technical data

Temperature range: -20°C up to +100°C

Part no.	Size metric	Diameter head mm	Diameter insert mm	Size total mm	Size head mm	Unit	net EUR/100 items at acceptance of		
							5 - 100	105 - 500	505 - 1000
903492*	M 16 x 1,5	13,5	9,7	20,7	5,7	50	o. r.	o. r.	o. r.
903493	M 20 x 1,5	15,8	12,0	18,0	8,0	50	o. r.	o. r.	o. r.
903494	M 25 x 1,5	19,9	16,4	18,3	7,3	50	o. r.	o. r.	o. r.
903495	M 32 x 1,5	24,1	20,4	21,2	9,2	50	o. r.	o. r.	o. r.
903496	M 40 x 1,5	32,0	27,5	25,2	9,2	50	o. r.	o. r.	o. r.

* only for cable glands type HT or HT-MS with clamping range 5-10 mm
Dimensions and specifications may be changed without prior notice

o. r. = on request

Multiple sealing inserts HT-MFDE / Sealing billets



HELUTOP® HT-MFDE

for HT gland shells

Material

NBR

Colours: black

Technical data

Temperature range: -20°C up to +100°C

Part no.	Size metric	Insert colour	Number x Ø borehole mm	Unit	net EUR/100 items at acceptance of		
					up to 100	101 - 500	501 - 1000
920102*	M 16 x 1,5	black	2x 4,0	50	o. r.	o. r.	o. r.
903575*	M 16 x 1,5	black	2x 4,5	50	o. r.	o. r.	o. r.
920104	M 20 x 1,5	black	2x 6,0	50	o. r.	o. r.	o. r.
920105	M 20 x 1,5	black	3x 4,0	50	o. r.	o. r.	o. r.
920106	M 20 x 1,5	black	3x 5,0	50	o. r.	o. r.	o. r.
920109	M 20 x 1,5	black	4x 3,0	50	o. r.	o. r.	o. r.
920112	M 25 x 1,5	black	3x 6,0	50	o. r.	o. r.	o. r.
920114	M 25 x 1,5	black	4x 5,0	50	o. r.	o. r.	o. r.
920117	M 25 x 1,5	black	6x 4,0	50	o. r.	o. r.	o. r.
903529	M 25 x 1,5	black	7x 3,0	50	o. r.	o. r.	o. r.
920122	M 32 x 1,5	black	3x 8,0	50	o. r.	o. r.	o. r.
920126	M 32 x 1,5	black	6x 5,0	50	o. r.	o. r.	o. r.
903530	M 32 x 1,5	black	6x 6,0	50	o. r.	o. r.	o. r.
903531	M 32 x 1,5	black	9x 3,0	50	o. r.	o. r.	o. r.
920129	M 32 x 1,5	black	9x 4,0	50	o. r.	o. r.	o. r.

* only for cable glands type HT or HT-MS with clamping range 5-10 mm

Fastening pins

Fastening pins for empty penetrations.

Material

Polyethylene

Technical data

Temperature range: -20°C up to +100°C

Part no. black	Part no. white	Diameter x length	Unit	net EUR/100 items at acceptance of		
				up to 100	101 - 500	501 - 1000
903515	903502	3,0 x 25,0	100	o. r.	o. r.	o. r.
903516	903503	4,0 x 20,0	100	o. r.	o. r.	o. r.
903517	903504	4,0 x 25,0	100	o. r.	o. r.	o. r.
	903505	5,0 x 25,0	100	o. r.	o. r.	o. r.
903518		5,3 x 25,0	100	o. r.	o. r.	o. r.
903519		6,0 x 25,0	100	o. r.	o. r.	o. r.
	903506	6,0 x 28,0	100	o. r.	o. r.	o. r.
903520	903507	6,4 x 25,0	100	o. r.	o. r.	o. r.
903521		7,0 x 25,0	100	o. r.	o. r.	o. r.
	903508	7,0 x 28,0	100	o. r.	o. r.	o. r.
903522	903509	7,5 x 20,0	100	o. r.	o. r.	o. r.
903523		8,0 x 20,0	100	o. r.	o. r.	o. r.
	903510	8,0 x 30,0	100	o. r.	o. r.	o. r.
903524		9,0 x 20,0	100	o. r.	o. r.	o. r.
	903511	9,0 x 30,0	100	o. r.	o. r.	o. r.
903525		9,3 x 20,0	100	o. r.	o. r.	o. r.
903526		10,0 x 20,0	100	o. r.	o. r.	o. r.
	903512	10,0 x 30,0	100	o. r.	o. r.	o. r.
	903513	11,0 x 30,0	100	o. r.	o. r.	o. r.
	903514	12,0 x 30,0	100	o. r.	o. r.	o. r.

Dimensions and specifications may be changed without prior notice

o. r. = on request

O-rings / Connection thread sealing rings PE

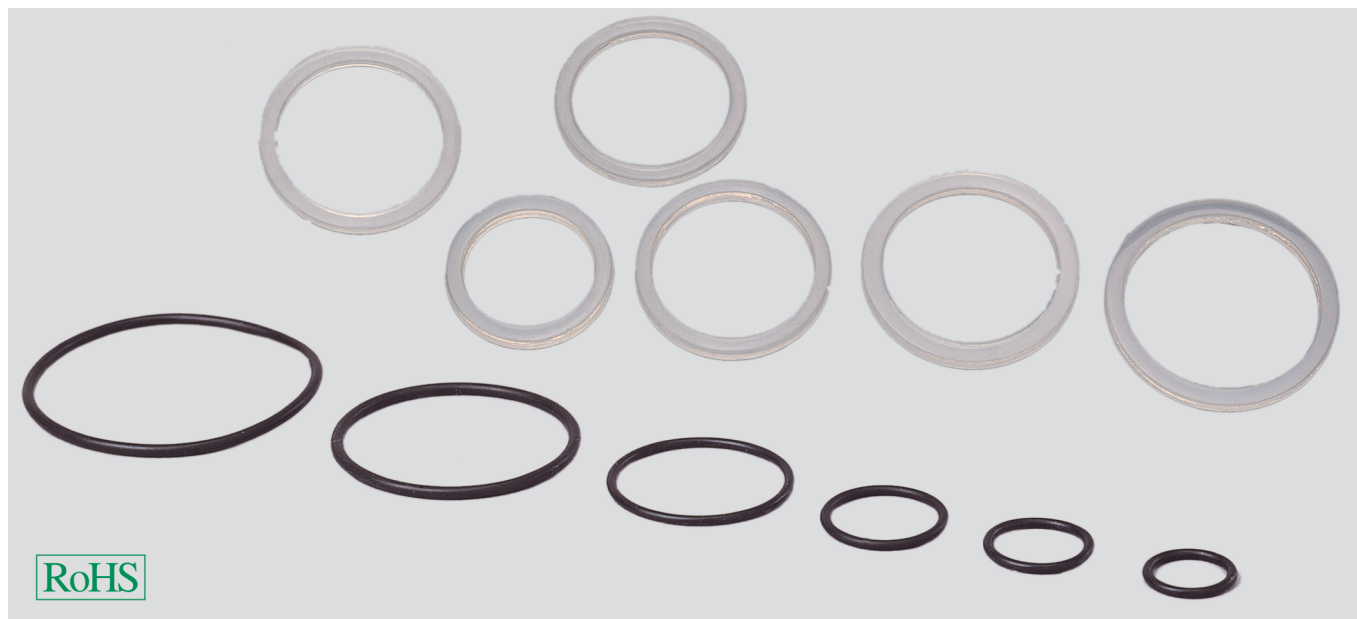

O-rings

O-rings for sealing against water, dust and oil.

Material

- halogen-free
- silicone-free
- phosphor-free

Buna-N

Colours: black

Technical data

Temperature range: -30°C up to +120°C

O-rings

Part no.	Size metric	Inner Ø mm	Outer Ø mm	Thickness mm	Unit	net EUR/100 items at acceptance of		
						up to 100	101 - 500	501 - 1000
90263	M 12 x 1,5	9,0	12,0	1,5	100	o. r.	o. r.	o. r.
90264	M 16 x 1,5	13,0	16,0	1,5	100	o. r.	o. r.	o. r.
90265	M 20 x 1,5	17,0	20,0	1,5	100	o. r.	o. r.	o. r.
90266	M 25 x 1,5	22,0	26,0	2,0	100	o. r.	o. r.	o. r.
90267	M 32 x 1,5	29,0	33,0	2,0	100	o. r.	o. r.	o. r.
90268	M 40 x 1,5	35,0	39,0	2,0	100	o. r.	o. r.	o. r.
90269	M 50 x 1,5	45,0	49,0	2,0	100	o. r.	o. r.	o. r.
90270	M 63 x 1,5	59,0	63,0	2,0	100	o. r.	o. r.	o. r.

AGDR-PE

Threaded connection rings for sealing against water and dust.

Material

- halogen-free
- phosphor-free
- cadmium-free

Polyethylene

Colours: natural

Technical data

Temperature range: -30°C up to +70°C

Connection thread sealing rings PE

Part no.	Size metric	Inner Ø mm	Outer Ø mm	Thickness mm	Unit	net EUR/100 items at acceptance of		
						up to 100	101 - 500	501 - 1000
90890	M 12 x 1,5	12,0	16,0	2,0	100	o. r.	o. r.	o. r.
90891	M 16 x 1,5	16,0	19,5	2,0	100	o. r.	o. r.	o. r.
90892	M 20 x 1,5	20,0	24,0	2,0	100	o. r.	o. r.	o. r.
90893	M 25 x 1,5	25,0	31,5	2,0	100	o. r.	o. r.	o. r.
90894	M 32 x 1,5	32,0	38,5	2,0	100	o. r.	o. r.	o. r.
90895	M 40 x 1,5	40,0	53,0	2,0	100	o. r.	o. r.	o. r.
90896	M 50 x 1,5	50,0	60,0	2,0	100	o. r.	o. r.	o. r.
90897	M 63 x 1,5	63,0	73,0	2,0	100	o. r.	o. r.	o. r.

Dimensions and specifications may be changed without prior notice

o. r. = on request

Blind plugs BL-H, BL-W

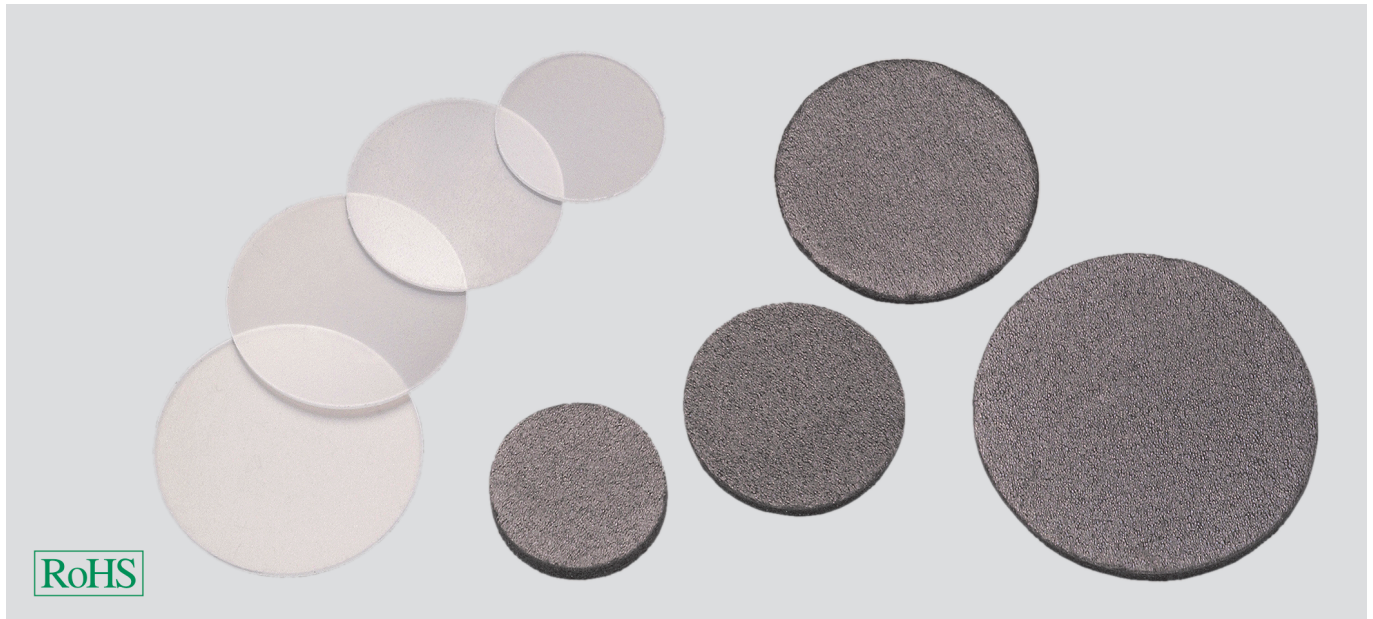

Blind plugs BL-H / BL-W

Blind plates as dust cap for HELUTOP® cable glands.

Material

H = Hard PVC
W = Foam

Technical data

Temperature range: -20°C up to +70°C

BL-H hard

Part no. clear	Size metric	Outer Ø mm	Unit	net EUR/100 items at acceptance of		
				up to 100	101 - 500	501 - 1000
96417	M 16 x 1,5	13,5	100	o. r.	o. r.	o. r.
96419	M 20 x 1,5	18,5	100	o. r.	o. r.	o. r.
96421	M 25 x 1,5	26,0	100	o. r.	o. r.	o. r.
96422	M 32 x 1,5	35,0	100	o. r.	o. r.	o. r.
96423	M 40 x 1,5	45,0	100	o. r.	o. r.	o. r.
96424	M 50 x 1,5	52,0	100	o. r.	o. r.	o. r.
96425	M 63 x 1,5	57,0	100	o. r.	o. r.	o. r.

BL-W soft

Part no. black	Size metric	Outer Ø mm	Unit	net EUR/100 items at acceptance of		
				up to 100	101 - 500	501 - 1000
96377	M 16 x 1,5	13,5	100	o. r.	o. r.	o. r.
96915	M 20 x 1,5	18,5	100	o. r.	o. r.	o. r.
96380	M 25 x 1,5	26,0	100	o. r.	o. r.	o. r.
96381	M 32 x 1,5	35,0	100	o. r.	o. r.	o. r.
96382	M 40 x 1,5	45,0	100	o. r.	o. r.	o. r.
96385	M 50 x 1,5	52,0	100	o. r.	o. r.	o. r.
96384	M 63 x 1,5	57,0	100	o. r.	o. r.	o. r.

Dimensions and specifications may be changed without prior notice

o. r. = on request

Approval to HELUTOP® HT

HELUTOP® HT-M cable gland from polyamide, metric thread

Approval certificate no. 138040

Approval certificate no. 134171

Type designation BM (corresponding to HELUTOP® HT-M)

For all products:

Temperature range: -20°C / +80°

Protection classification: IP 68 - 5bar (30min.)

Size metric	Sealing range mm	Clamping range of Strain relief mm	Category of Strain relief	Installation torque tested to EN 50262* Nm	Category of Impact effect
M12x1,5	3-6	3-6	A	1,7/2,5	2
M16x1,5	4-8	4-8	A	2,5/3,75	2
M16x1,5	5-10	5-10	A	2,5/3,75	2
M20x1,5	6-12	6-12	A	3,3/3,75	2
M20x1,5	10-14	10-14	A	3,3/3,75	2
M25x1,5	12-17	12-17	A	5,0/7,5	2
M25x1,5	13-18	13-18	A	5,0/7,5	2
M32x1,5	15-21	15-21	A	12/7,5	4
M32x1,5	18-25	18-25	A	12/7,5	4
M40x1,5	19-28	19-28	A	12/7,5	4
M40x1,5	22-31	22-31	A	12/7,5	4
M50x1,5	30-36	30-36	A	12/7,5	4
M63x1,5	34-44	34-44	A	12/7,5	4
M63x1,5	35-44	35-44	A	12/7,5	4

*Cap nut/gland and/or locknut

			VDE	UL	UR	CSA	
Helutop HT	metric	M12 - M16	VDE		UR	CSA	
		M20 - M63			UL		
	PG	PG7 - PG11	-	UR			
		PG13,5 - PG48		UL			
NPT	3/8" - 1"		UL				
Helutop HT-R	metric, reduced	M12 - M63	VDE		-	CSA	
Helutop HT-BS	metric	M12 - M16	VDE		UR	CSA	
		M20 - M63			UL		
Helutop HT-K	metric	M12 - M16	-		UR	CSA	
		M20 - M25			UL		
	PG	PG7 - PG11			UR		
		PG13,5 - PG21			UL		
NPT	3/8" - 1"	UL					
Helutop-HT-MS	metric	M12 - M16	VDE		UR	-	
		M20 - M63			UL		
	PG	PG7 - PG48	-				
		NPT	3/8" - 1"	UL			
Helutop MS-R	metric, reduced	M12 - M63	VDE		-	-	
Helutop MS-EP	metric	M12 - M16	-		UR	-	
		M20 - M63			UL		
	NPT	3/8" - 1"			UL		
Helutop MS-E	PG	PG7 - PG48	-		-	-	
Helutop HT-E	metric	M12 - M16	-		UR	-	
		M20 - M63			UL		
	PG	PG7 - PG48			-		
		NPT			3/8" - 1"		UL
Updated: 26 January 2009							

Contact – Germany

Sales office

D-25524 Itzehoe
Bahnhofstraße 9

Telephone +49 4821 40394-0 • Fax +49 4821 40394-29

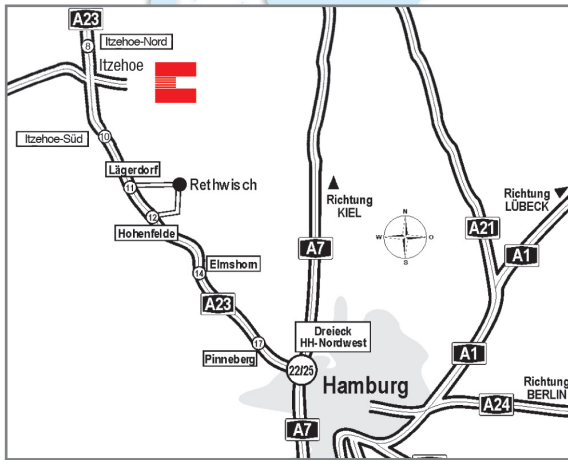

Sales office and stock

D-15366 Neuenhagen/Berlin
Zum Mühlenfließ 1

Telephone +49 3342 2397-0 • Fax +49 3342 80033



Sales office

D-47269 Duisburg

Am Handwerkershof 2-4

Telephone +49 203 73995-0 • Fax +49 203 73995-210

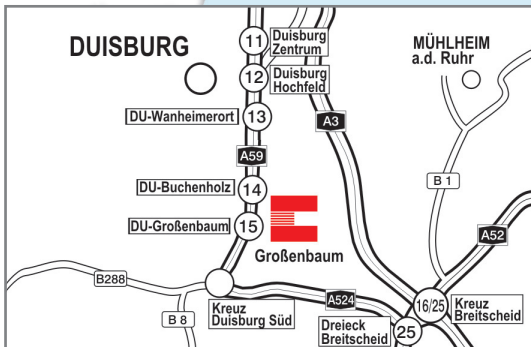

Sales office and stock

D-09212 Limbach/Oberfrohna

Eichelbergstraße 7

Telephone +49 3722 6086-0 • Fax +49 3722 6086-420

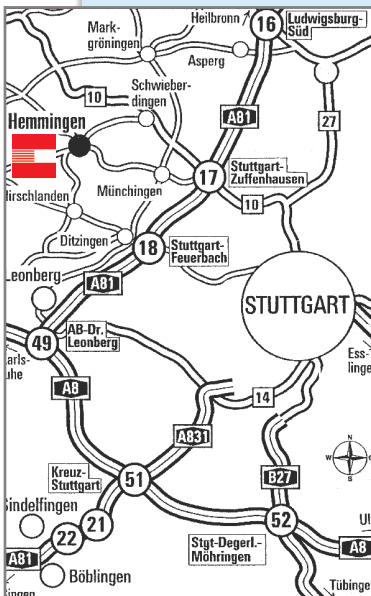
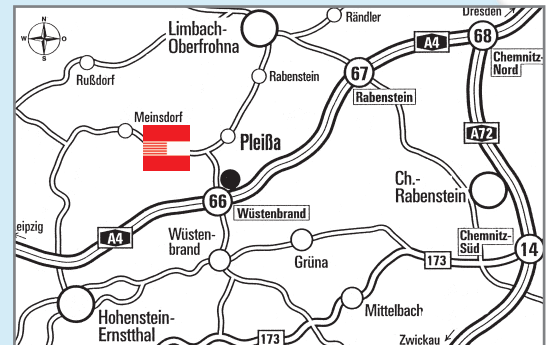

Headquarters

D-71282 Hemmingen
Dieselstraße 8-12

Telephone +49 7150 9209-0
 Fax +49 7150 8884

Development & production

D-91575 Windsbach/Nuremberg

Neuseser Weg 11

Telephone +49 9871 6793-0 • Fax +49 9871 1055

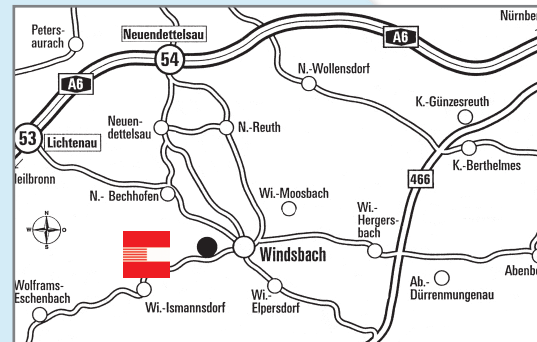

Contact – International

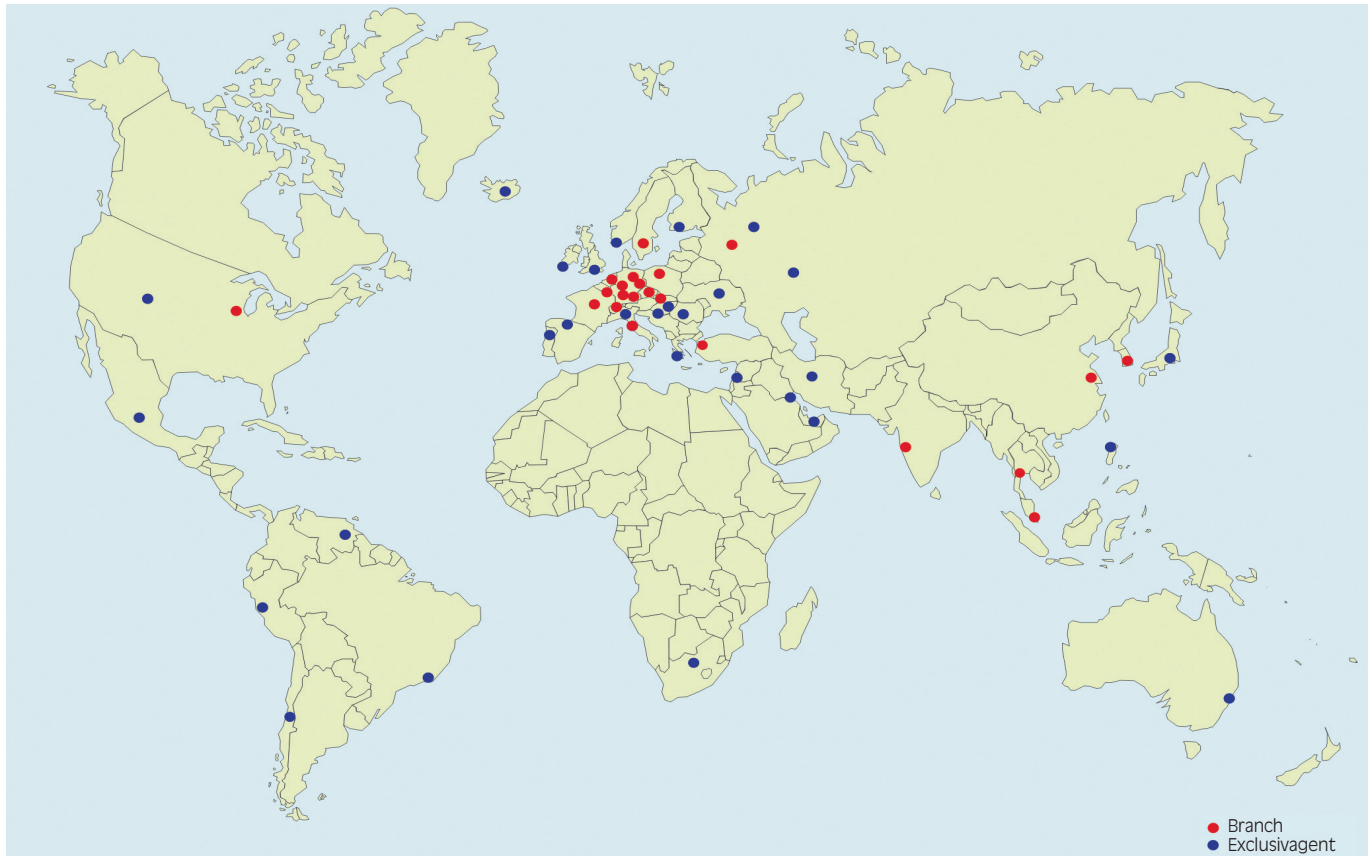

How to find our export department: Ph. +49 7150 9209-337 · Fax +49 7150 8884 · E-mail info@helukabel.de

HELUKABEL AG (CH)

Grabäckerstraße 60 · CH-8957 Spreitenbach
Tel. +41 56 4181515 · Fax +41 56 4181516
contact@helukabel.ch

Büro Suisse Romande (CH)

Tel. +41 24 4414414 · Fax +41 24 4414412

HELUKABEL Italia S.r.l.

Via delle Rovedine 23 · I-23899 Robbiate (LC)
Mobile: +39 3465861390
Tel. +39 039 9515450 · Fax +39 039 9281579
info@helukabel.it

HELUKABEL Polska Sp. z o.o. (PL)

Krze Duże 2 · PL-96325 Radziejowice
Tel. +48 46 85801-00 · Fax +48 46 85801-17/-18
biuro@helukabel.pl

HELUKABEL B.V. (NL)

De Kempen 4 · NL-6021PZ Budel/Eindhoven
Tel. +31 495 499049 · Fax +31 495 499048
info@helukabel.nl

HELUKABEL France SARL (F)

3, rue DMC-B.P. 30 · Z.A. du Pont d'Aspach
F-68520 Burnhaupt le haut
Tel. +33 389627562 · Fax +33 389627700
info@helukabel.fr

HELUKABEL Belgium BVBA

Z.1 Researpark 310 · B-1731 Zellik
Tel. +32 24810020 / +32 478426727
Fax +32 24810022
luc.rediers@helukabel.be

HELUKABEL China (CN)

1st Floor, Bldg. No.4, 668 HengAn Rd.
Pudong New Dist. Shanghai, China
PRC-200137 Shanghai
Tel. +86 21 58696108 · Fax +86 21 58693666
service@helukabel.com.cn

HELUKABEL AB (S)

Spjutvägen 1 · S-17561 Järfälla
Tel. +46 8 7617805 · Fax +46 8 6210059
info@helukabel.se

HELUKABEL CZ s.r.o. (CZ)

Areál dolu Max · CZ-27306 Linbušín/Kladno
Tel. +42 0 312672620 · Fax +42 0 312672621
prodej@helukabily.cz

HELUKABEL (RUS)

Tel. +49 7150 9209389 · Fax +49 7150 922695
kanarikov@helukabel.de

HELUKABEL India PVT LTD. (IN)

F-305 Kailash Complex
Hiranandani Gardens Link Road,
Vikhroli West, Mumbai - 400 079
Tel. +91 22 25185841 · Fax +91 22 25185839
Cell. 9324048933
info@heluindia.com

HELUKABEL Singapore Pte. Ltd. (SGP)

No. 3, New Industrial Road · #01-01 Kimly
Building
Singapore 536197
Tel. +65 64880170 · Fax +65 62851513
sales@helukabel.com.sg

HELUKABEL Korea Co. Ltd. (KR)

521-17 Daejeo 2 Dong Gang-seo Gu,
ROK - Busan Korea
Tel. +82 51 972-8646 · Fax +82 51 972-8649
huk365@helukabel.co.kr

HELUKABEL Thailand Co. Ltd. (THA)

73/4 Moo.1 Bangkrauy-Sainoi Rd.,
Banglane, Bangyai,
11140 Nonthaburi, Thailand
Tel. +66 29273570-3 / +66 25954401-4
Fax +66 29215402
sales@helukabel.co.th

HELUKABEL Slovakia (SK)

Balazi Kamil, Palkovicova 4087/6
SK-95501 Topolcany · Tel. +42 1915751549
balazi@helukabel.sk

HELUKABEL Kablo San. ve Tic.Ltd Sti. (TR)

Siyavuspasa Cad. Cevizlik Sok., Birlik Ap. 19/1
34182 Bahcelievler-Istanbul Turkey
Tel. +90 2125024195 · Fax +90 2125024198
GSM +90 5334831788
demirkiran@helukabel.com.tr

HELUKABEL USA, Inc.

1355 Bowes Road, Unit C, Elgin, IL 60123
Tel. +1 8479305118 · Fax +1 8476228766
info@helukabel.com



HELUKABEL®

Cable accessories

Fax enquiry

Fax +49 7150 8884

Sender / stamp

Should you have any questions, our specialist advisers will also be glad to help you by telephone.
Tel. +49 7150 9209-0

Contact person

Description	Art No.	Quantity/pcs.	Desired delivery date

We would like to learn more about HELUKABEL® and hereby request:

Catalogue

- Cables & Wires
- Cable Accessories
- Data, Network & Bus Technology
- Media Technology

Information via

- General documentation
- Customer visit
- Quotation for: _____

Remark/comment: _____

HELUKABEL® GmbH
 Headquarters
 Dieselstraße 8-12
 D-71282 Hemmingen
 Ph. +49 7150 9209-0
 Fax +49 7150 8884



HELUKABEL®

The Logistic Centre Hemmingen



**HELUKABEL® GmbH
Headquarters**

Dieselstraße 8-12
D-71282 Hemmingen
Germany

Phone +49 7150 9209-0

Fax +49 7150 8884

info@helukabel.de

Other branches:

Switzerland · France · Sweden · Italia
Belgium · Netherlands · Poland
Czech Republic · Slovakia · Turkey
China · Singapore · India · Thailand
South Korea · Russia · USA