

Technical data sheet

Cable gland, PG thread, set with locknut, light grey

Art.-Nr. 2024665



The quickest and most convenient way of providing strain relief and tightness with cable glands on junction boxes and housings is with the tried-and-trusted V-TEC VM cable glands from OBO. With the integrated sealing lip and the special OBO slat technology, protection class IP68 is achieved. Strain relief and tightness have been tested to DIN EN 62444.

The connecting threads of the cable glands are metric or PG and are therefore suitable for universal use. Once screwed in place, the installation is there forever, as the optimum thread adjustment with the right pitch ensures permanent resistance to shaking.

Applications: From private housing with junction boxes up to industrial applications in the distributor cabinet.

Temperature range: -20 °C to +65 °C.



PA Polyamide

Product additional text 1

Table column D1: sealing range to VDE 0619, in which no strain relief is required.

Product additional text 2

Table column D2: sealing range including strain relief and twist protection to VDE 0619

Master data

Item No.	2024665
Type	V-TEC PG21+ LGR
Description 1	Cable gland
Description 2	with locknut
Dimension	PG21
Colour	Light grey
RAL number	7.035,00
Material	Polyamide
Material symbol	PA
Smallest sales unit	25,00 pcs
Weight	2,76 kg/100 pcs.

Technical specifications

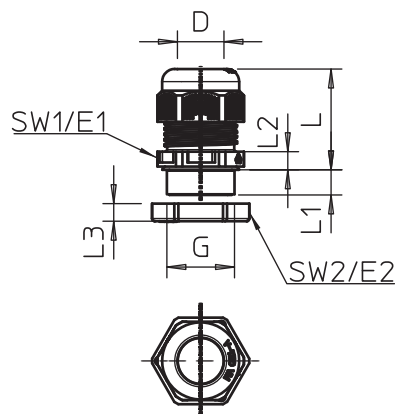

Dimension E1	37,50 mm
Dimension E2	39,00 mm
Dimension L min.	28,00 mm
Dimension L max.	38,00 mm
Dimension L1	11,00 mm
Dimension L2	6,00 mm
Dimension L3	7,00 mm
SW 1	33,00 mm
SW 2	36,00 mm
Version	Straight
Type of seal	Sealing ring
Bend protection	<input checked="" type="checkbox"/>
Sealing range D	9,00 - 18,00 mm
Sealing range D	0,55 - 0,71 in
explosion-proof	<input checked="" type="checkbox"/>
Flat cable threaded connection	<input checked="" type="checkbox"/>
For Ex zone	Without
For Ex zone gas	Without
For Ex zone dust	Without
Thread	Pg 21

Technical data sheet

Cable gland, PG thread, set with locknut, light grey

Art.-Nr. 2024665



Technical specifications

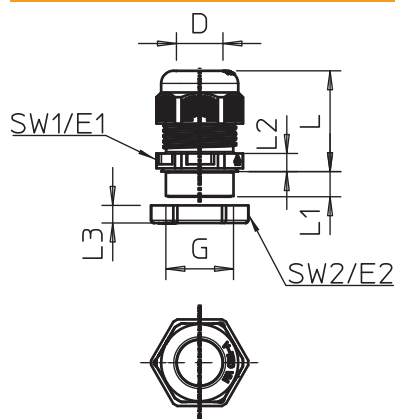

Thread type	PG
Thread length	11,00 mm
Thread increase	1,50 mm
Nominal thread size	21,00
Glass-fibre reinforced	<input checked="" type="checkbox"/>
Halogen-free	<input checked="" type="checkbox"/>
Multiple sealing insert	<input checked="" type="checkbox"/>
With locknut	<input checked="" type="checkbox"/>
Impact resistant	<input checked="" type="checkbox"/>
Hexagonal corner dimension	37,50 mm
Protection rating	IP68
Splittable gland	<input checked="" type="checkbox"/>
Strain relief and wringing protection D2	12,00 - 18,00 mm
Strain relief option	<input checked="" type="checkbox"/>