

## Smart Latching Relay with Netatmo

Cat. number: FC80RC



Beforehand requires the installation of a "Starter Pack" or a "Module Control".

| CONTENTS                            | Pages |
|-------------------------------------|-------|
| 1. Description - Use.....           | 1     |
| 2. Range .....                      | 1     |
| 3. Overall dimensions .....         | 1     |
| 4. Preparation - Connection .....   | 1     |
| 5. General characteristics .....    | 5     |
| 6. Compliance and approvals.....    | 6     |
| 7. Auxiliaries and accessories..... | 6     |

### 1. DESCRIPTION - USE

#### Use:

Allows to remotely control (ON / OFF) lightings previously controlled by push buttons (wireless and/or wired type) by smartphone with "Home+Control" app and/or by voice via a voice assistant. This connected version also offers functions as:

- Energy consumption: automatically energy consumption information is available for the circuit to whom the latching relay is wired to.

- Scheduling: automatic opening and reclosing action scenarios based on a timeline. (daily/weekly/specific event such as "holidays")

#### Symbol:

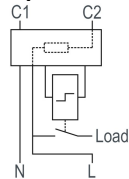

### 2. RANGE

#### Noise level:

. Silent switch: <10dB

#### Width:

. 1 module. 17.8 mm wide

#### Types of contact:

. Closing contact " F "



#### Rated current:

. 20 A

#### Rated voltage:

. 240V AC

#### Rated frequency:

. 50 Hz

#### Poles:

. 1 pole «1F»

### 2. RANGE (continued)

#### Configuration and use:

. Can be used as a " standard " latching relay not connected And /Or

Can be used with:

- Legrand smartphone app  
" HOME + CONTROL "



. Available for free on Google Play or App Store

- Voice assistants (compatible with the main voice assistants of the market).



### 3. OVERALL DIMENSIONS

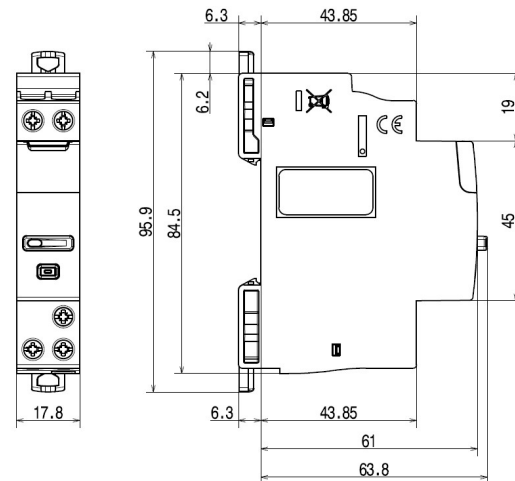

### 4. PREPARATION - CONNECTION

#### Mounting:

. On symmetrical rail EN / IEC 60715 or DIN 35.

#### Operating position:

. Vertical, Horizontal, Flat.

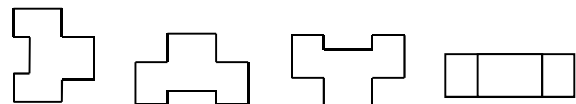

## 4. PREPARATION - CONNECTION *(continued)*

### Row positioning:

The product shape and the positioning of the terminals allow the passage of single-line, three-lines and plug-in supply busbars in the upper part of the product. Then, it is possible to freely choose the position of the Connected Latching Relay in the row and to connect by supply busbar the other devices put on the same DIN rail.

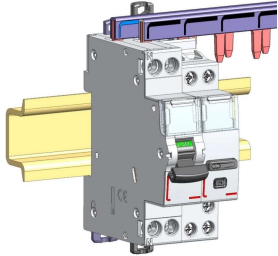

### Module maintenance:

It is possible to switch a Connected Latching Relay in the middle of a row supplied with an upstream busbar without disconnecting the other devices on the same DIN rail.

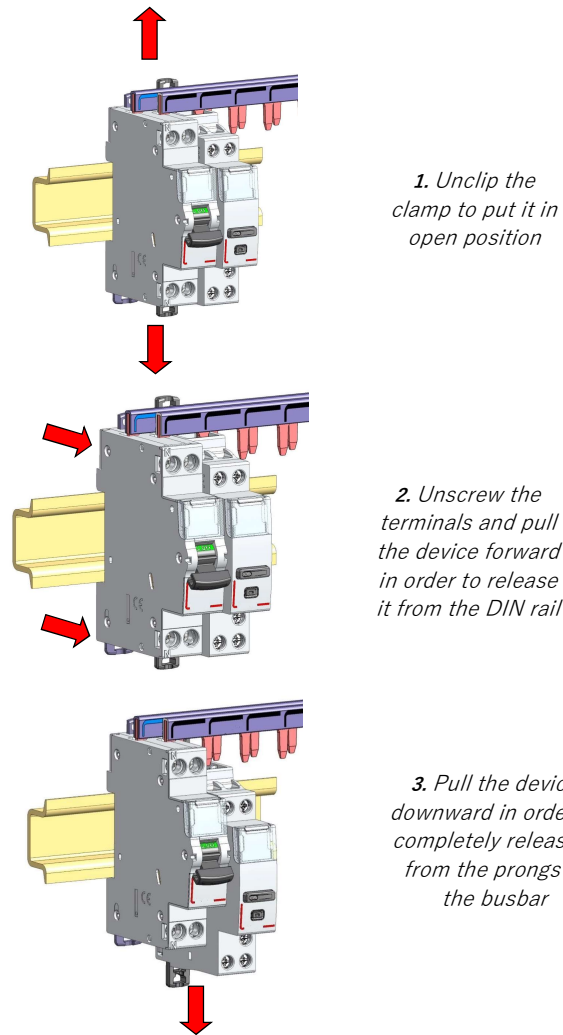

## 4. PREPARATION - CONNECTION *(continued)*

### Wiring of the upstream terminals:

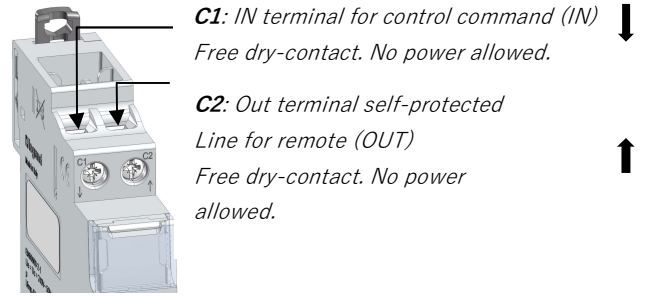

In case of a remote control done via a wired push button, the control is done either via C1 and C2 terminals.

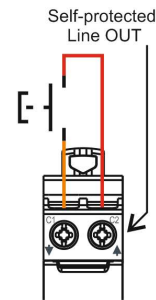

Or via a push button through the phase line protected by a circuit breaker on terminal C1

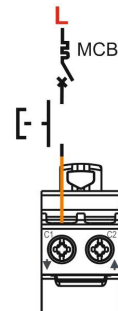

**Warning:** Do not wire from Neutral to C1 or C2

### Wiring of the power supply and the load (downstream terminals):

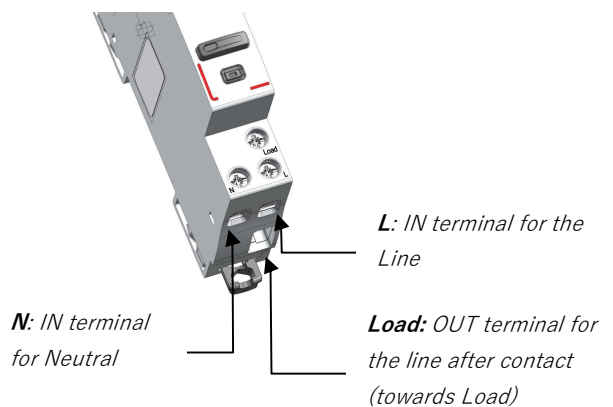

## 4. PREPARATION - CONNECTION (continued)

### Wiring diagrams:

- N (neutral) = blue
- L (Line) = everything but blue and green/yellow
- Line after contact = usually purple, orange...

. Wired installation:

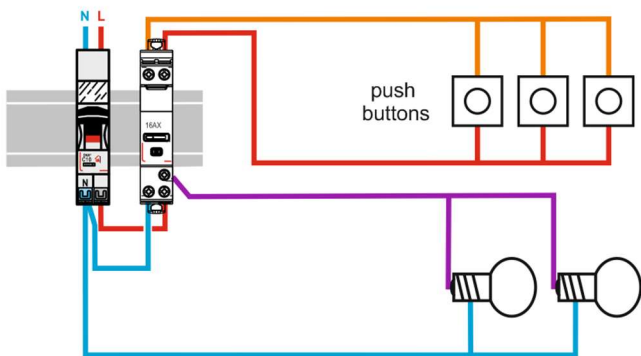

. Wired and wireless mixed installation:

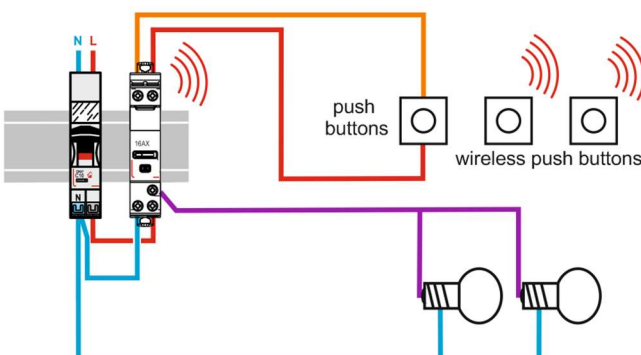

. Wired installation with junction box:

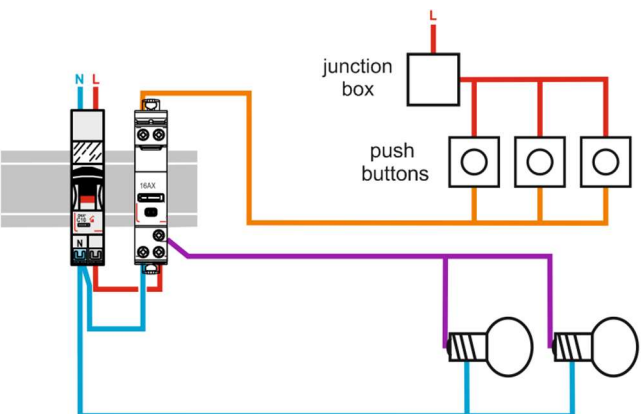

## 4. PREPARATION - CONNECTION (continued)

### Wiring diagrams (continued):

. Wireless installation:

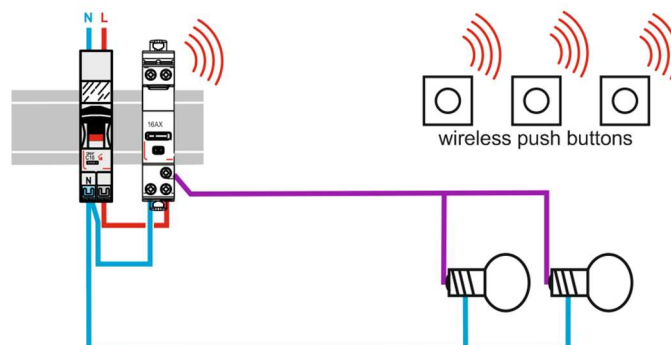

### Recommended tools:

- . For the terminals: screwdriver Pozidriv n° 1 or flat-blade 4 mm.
- . For clamping: screwdriver flat-blade (5,5 mm or less) or Pozidriv n° 1

### Connection:

. Control and power screw terminals:

- Terminal type: cage
- Depth: 9 mm
- Stripping length recommended: 9 mm
- Screw head: Posidriv n° 1 or slotted
- Type of screw: M3,5
- Minimum tightening torque: mini 0.8 Nm / maxi: 1.4 Nm advised: 1 Nm

### Conductor type for remote control terminals (C1, C2):

. Copper cables

|                | Without ferrule                                                       | With ferrule                                                           |
|----------------|-----------------------------------------------------------------------|------------------------------------------------------------------------|
| Rigid cable    | 1x (0.75 to 2.5mm <sup>2</sup> )<br>2 x (0.75 to 1.5mm <sup>2</sup> ) | -                                                                      |
| Flexible cable | 1x (0.75 to 2.5mm <sup>2</sup> )<br>2 x (0.75 to 1.5mm <sup>2</sup> ) | 1 x (0.75 to 2.5mm <sup>2</sup> )<br>2 x (0.75 to 1.5mm <sup>2</sup> ) |

### Conductor type for power terminals (N, L, LOAD):

. Copper cables

|                | Without ferrule                                                     | With ferrule                                                           |
|----------------|---------------------------------------------------------------------|------------------------------------------------------------------------|
| Rigid cable    | 1x (0.75 to 6mm <sup>2</sup> )<br>2 x (0.75 to 2.5mm <sup>2</sup> ) | -                                                                      |
| Flexible cable | 1x (0.75 to 6mm <sup>2</sup> )<br>2 x (0.75 to 2.5mm <sup>2</sup> ) | 1 x (0.75 to 2.5mm <sup>2</sup> )<br>2 x (0.75 to 1.5mm <sup>2</sup> ) |

## 4. PREPARATION - CONNECTION *(continued)*

### Remote control commands:

. Operation on-site, directly with the front face push-button of the device.

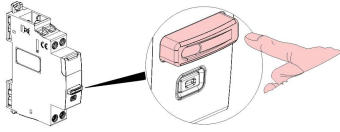

. Via on-wall push-button control wireless or standard "wired" ones (refer to # wiring diagrams)

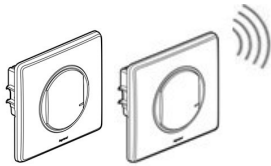

. Via the General Scenario Wireless Command « Departure/Arrival »

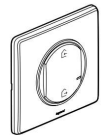

. Via smartphone with the Home + Control smartphone app





. By voice through a vocal assistant.

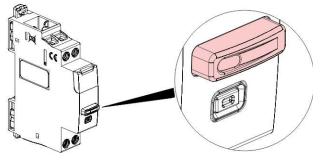

### Visualization of the operating mode of the device and contacts:

. Via the LED, on the push button command







| Color                                                                               | Status | Meaning                              |
|-------------------------------------------------------------------------------------|--------|--------------------------------------|
|  | OFF    | Manual mode and opened Contact (OFF) |
|  | Fixed  | Manual mode and closed Contact (ON)  |

## 4. PREPARATION - CONNECTION *(continued)*

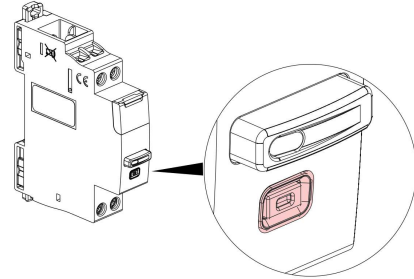
### Visualization of the setup:

. Via the LED on the settings button



| Color                                                                                       | Status | Meaning                                                                                               |
|---------------------------------------------------------------------------------------------|--------|-------------------------------------------------------------------------------------------------------|
| <br>Red    | Fixed  | Temporary status. Device not connected to the radio network                                           |
| <br>Green | Fixed  | Temporary status. Device correctly paired to the radio network (when the radio network is still open) |
|          | OFF    | Normal status. Device paired to the radio network (when the radio network is closed)                  |

### Configurations and actions

. Refer to the online guides and to the indications provided through the Home + Control application.

### Self-protection

. The load is disconnected (OFF) if the current exceeds the rated value for more than 7.5 seconds.

### Labelling:

. Circuit identification by way of a label inserted in the label holder situated on the front of the product.

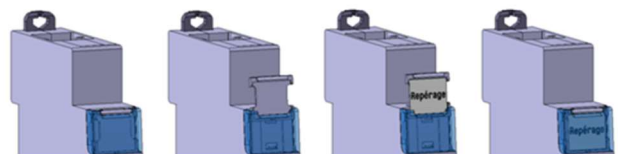

## 5. GENERAL CHARACTERISTICS

### Marking of the Connected Latching Relay:

Markings of the front side:



Terminal markings:



Markings on the upper side

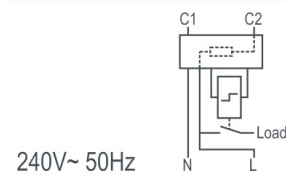

Lateral markings

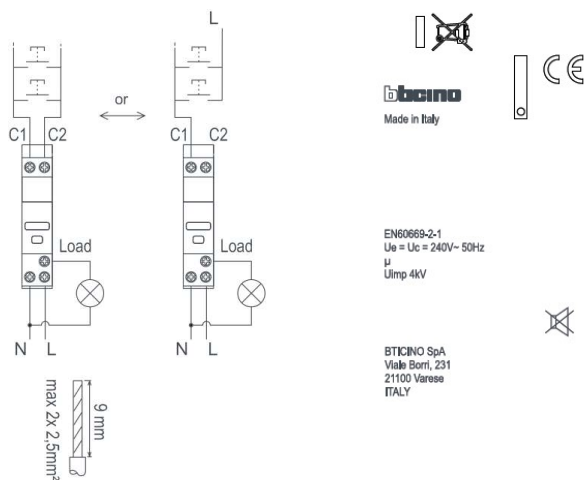

## 5. GENERAL CHARACTERISTICS (continued)

### Sectioning distance:

. micro-gap contact according to the standard EN 60669-2-1

### Rated insulation voltage (Ui):

.  $U_i = 250 \text{ V} \sim$

### Degree of pollution:

. 2

### Rated impulse withstand voltage (Uimp):

. 4 kV

### Influence of altitude:

. No influence up to 2 000 m

### Assigned frequency:

. 50 Hz

### Rated voltage of use (Ue):

.  $U_e = 240 \text{ V} \sim$

### Resistance to short-circuits:

. Presumed short circuit current 1500 A according to EN 60669-2-1

. Thermal stress: 15 000 A<sup>2</sup>s to EN 60669-2-1

### Recommendations:

. For the device protection against short circuits according to the conditional current, it is recommended to use a circuit breaker or fuse gG rated current  $\leq 16 \text{ A}$ .

### Endurance:

. 20 000 000 operations without load

. 10000 operations under fluo load according to EN 60669-2-1

. 10000 operations under inductive load according to EN 60669-2-1

. 10000 operations under load SBL650W according to EN 60669-2-1

. 200000 operations under resistive load according to EN 60669-2-5

### Characteristics of the radio interface:

. Standard IEEE 802.15.4

. Frequencies 2,4 à 2,4835Ghz

. Transmitter output power <100mW

### Dielectric resistance:

. 2000V between front face and rail.

. 750V between upstream and downstream

### Protection degree:

. Protection index of terminals against direct contacts: IP2X (IEC/EN 60529)

. Protection index of the front face against direct contacts: IP3XD (IEC/EN 60529)

. Class II, front panel with faceplate.

. Class of protection against mechanical impacts IK04 (IEC/EN 62262)

## 5. GENERAL CHARACTERISTICS *(continued)*

### Vibrations and shaking resistance:

- . vibrations: 10 to 55 to 10Hz single amplitude 0.75mm
- . Shaking: 1000m / s<sup>2</sup> (6 ± 1ms)

### Plastic material:

- . Self-extinguishing polycarbonate.
- . Heat and fire resistant according to IEC/EN 60669-2-1, glow-wire test at 960° C
- . Classification UL 94 V0 (≥1.5mm)

### Ambient operating temperature:

- . Min. = - 5 ° C Max. = + 45 ° C.

### Ambient storage temperature:

- . Min. = - 40 ° C Max. = + 70 ° C.

### Average weight:

- . 78g

### Volume when packed:

- . 0,17 dm<sup>3</sup>.

### Environmental profile:

- . PEP document available

### Installation software:

- . XL PRO3

## 6. COMPLIANCE AND APPROVALS

### Compliance to standards:

- . NF EN 60669-2-1 / IEC 60669-2-1

### Environment respect – Compliance with European Union Directives:

- . Compliance with Directive 2002/95/EC of 27/01/03
- . Compliance with the Directive 91/338/EEC of 18/06/91
- . Compliant with regulation REACH

### Conformity with electromagnetic interference (EMC):

- . Compliant EN 301 489-1, IEC 60669-2-5, NF EN 60669-2-1
- . Immunity to shock waves
- . Radio transmission
- . Immunity to electrical transients in bursts.
- . Immunity to conducted disturbances induced by radio fields
- . Immunity to radiated fields
- . Electrostatic discharge immunity
- . Immunity to voltage dips and short break
- . Compliance mission radiated according to NF EN55032.

### Plastic materials:

- . Halogen-free plastics.
- . Marking of parts according to ISO 11469 and ISO 1043.
- . ISO 7000: 2004, Graphical symbols to be used on equipment - Index and synopsis

### Packaging:

- . Design and manufacture of packaging in accordance with Decree 98-638 of 20/07/98 and Directive 94/62 / EC.

## 7. AUXILIARIES AND ACCESSORIES

Beforehand, requires the installation of a " starter pack " or " a Module Control ".

