

## Features

### Multi-function and multi-voltage timer

- One module 17.5 mm wide housing
- Seven functions (4 with supply start and 3 with signal start)
- Additional Reset function
- Six time ranges from 0.1s to 10h
- 35 mm rail (EN 60715) mounting

81.01  
Screw terminal

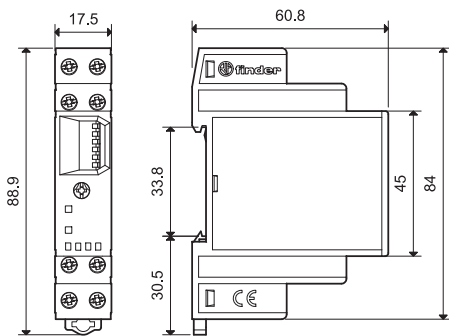

**NEW** 81.01



- Multi-voltage (DC non polarized)
- Multi-function
- 35 mm rail (EN 60715) mounting

**AI:** ON delay  
**DI:** ON pulse  
**SW:** Symmetrical recycling: ON start  
**SP:** Symmetrical recycling: OFF start  
**BE:** Signal OFF delay  
**DE:** Signal ON pulse  
**EE:** Signal OFF pulse

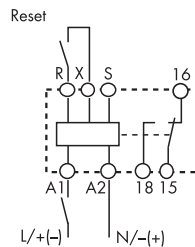

Wiring diagram  
(Supply START)

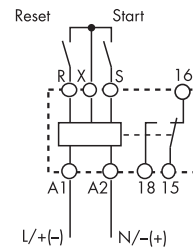

Wiring diagram  
(Signal START)

Contact specification		
Contact configuration		1 CO (SPDT)
Rated current/Maximum peak current	A	16/30
Rated voltage/Maximum switching voltage V AC		250/400
Rated load AC1	VA	4000
Rated load AC15 (230 V AC)	VA	750
Single phase motor rating (230 V AC)	kW	0.55
Breaking capacity DC1: 30/110/220 V	A	16/0.3/0.12
Minimum switching load	mW (V/mA)	500 (10/5)
Standard contact material		AgCdO
Supply specification		
Nominal voltage (U <sub>N</sub> )	V AC (50/60 Hz)	12...230
	V DC	12...230 (non polarized)
Rated power AC/DC	VA (50 Hz)/W	< 2 / < 2
Operating range	V AC	10.8...250
	V DC	10.8...250
Technical data		
Specified time range		(0.1...1)s, (1...10)s, (10...60)s, (1...10)min, (10...60)min, (1...10)h
Repeatability	%	± 1
Recovery time	ms	≤ 50
Minimum control impulse	ms	50
Setting accuracy-full range	%	± 5
Electrical life at rated load in AC1	cycles	100·10 <sup>3</sup>
Ambient temperature range	°C	-10...+50
Protection category		IP 20
Approvals (according to type)		<b>CE</b>

## Ordering information

Example: 81 series, modular timer multi-voltage, 1 CO (SPDT) - 16 A, supply rated at (12...230)V AC/DC.

**8 1 . 0 1 . 0 . 2 3 0 . 0 0 0 0**

**Series** \_\_\_\_\_  
**Type** \_\_\_\_\_  
 0 = Multi-function (AI, DI, SW, SP, BE, DE, EE)  
**No. of poles** \_\_\_\_\_  
 1 = 1 CO (SPDT)

**Supply voltage**  
 230 = (12 ... 230)V AC/DC  
**Supply version**  
 0 = AC (50/60 Hz)/DC

## Technical data

EMC specifications			
Type of test	Reference standard		
Electrostatic discharge	contact discharge	EN 61000-4-2	4 kV
	air discharge	EN 61000-4-2	8 kV
Radio-frequency electromagnetic field (80 ÷ 1000 MHz)		EN 61000-4-3	10 V/m
Fast transients (burst) (5-50 ns, 5 kHz) on Supply terminals		EN 61000-4-4	4 kV
Surges (1.2/50 µs) on Supply terminals	common mode	EN 61000-4-5	4 kV
	differential mode	EN 61000-4-5	4 kV
Radio-frequency common mode (0.15 ÷ 80 MHz) on Supply terminals		EN 61000-4-6	10 V
Radiated and conducted emission		EN 55022	class A
Other data			
Current absorption on signal control (B1)		< 1 mA (S-X)	< 1 mA (R-X)
Voltage potential on the input terminal R - X and S -X		Not galvanic separation from the supply voltage on A1 - A2	
Power lost to the environment	without contact current	W	1.3
	with rated current	W	3.2
Screw torque		Nm	0.8
Max. wire size		solid cable	stranded cable
		mm <sup>2</sup>	1x4 / 2x2.5
		AWG	1x12 / 2x14

## Time range setting

	(0.1...1)s	(1...10)s	(10...60)s	(1...10)min	(10...60)min	(1...10)h
1						
2						
3						
4						
5						
6						

NOTE: time range and function must be set before energising the timer.

**Functions**

- U** = Supply voltage
- S** = Signal switch
- R** = Reset
- = Output contact

LED (green)	LED (red)	Supply voltage	NO output contact	Contacts	
				Open	Closed
		OFF	Open	15 - 18	15 - 16
		ON	Open	15 - 18	15 - 16
		ON	Closed	15 - 16	15 - 18

Supply Start = Start via contact in supply line (A1).  
 Signal Start = Start via contact into control terminal (B1).

**Wiring diagram**

**Supply START**

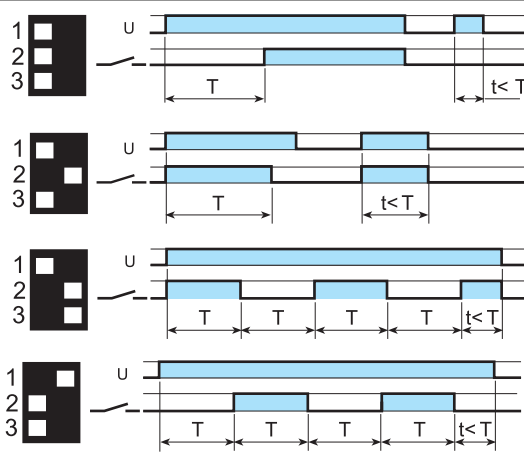
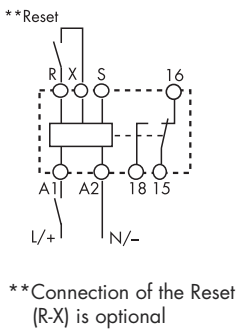

**(AI) ON delay.**  
 Apply power to timer. Output contacts transfer after preset time has elapsed. Reset occurs when power is removed.

**(DI) ON pulse.**  
 Apply power to timer. Output contacts transfer immediately. After the preset time has elapsed, contacts reset.

**(SW) Symmetrical recycling: ON start.**  
 Apply power to timer. Output contacts transfer immediately and cycle between ON and OFF for as long as power is applied. The ratio is 1:1 (time on = time off).

**(SP) Symmetrical recycling: OFF start.**  
 Apply power to timer. First transfer of contact occurs after preset time has elapsed. The timer now cycles between OFF and ON as long as power is applied. The ratio is 1:1 (time on = time off).

**Signal START**

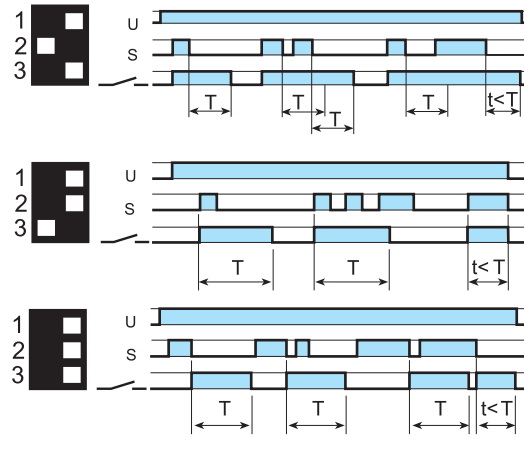
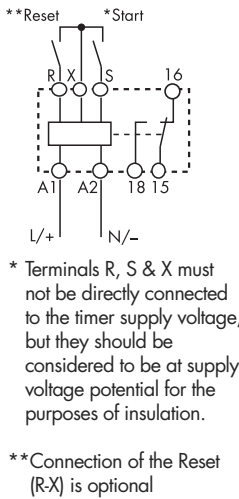

**(BE) Signal OFF delay.**  
 Power is permanently applied to the timer. The output contacts transfer immediately on closure of the Signal Switch (S). Opening the Signal Switch initiates the preset delay, after which time the output contacts reset.

**(DE) Signal ON pulse.**  
 Power is permanently applied to the timer. On momentary or maintained closure of Signal Switch (S), the output contacts transfer, and remain so for the duration of the preset delay, after which they reset.

**(EE) Signal OFF pulse.**  
 Power is permanently applied to the timer. On opening of the Signal Switch (S) the output contacts transfer, and remain so for the duration of the preset delay, after which they reset.

**RESET function (R)**

For each and every function and time range, the timer is immediately reset when the reset switch is closed.

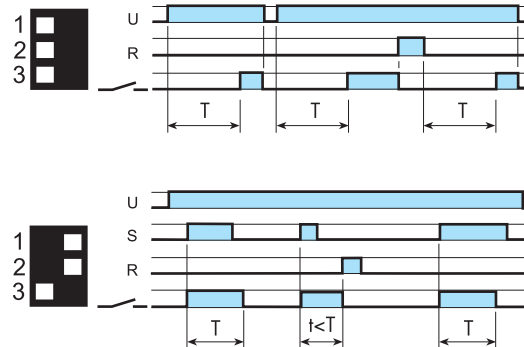

Example:  
 Supply START; ON delay function  
**Closing the external reset switch immediately resets the timer. Opening the reset switch re-initiates the timing function.**

Example:  
 Signal START; ON pulse function.  
**Closing the external reset switch terminates the interval time and resets the timer. To re-start, it is necessary to open the reset switch, before closing the signal START contact.**

## Accessories



019.01

**Identification tag**, for types 81.01, plastic, 1 tag, 17x25.5 mm

019.01



060.72

**Sheet of marker tags**, for types 81.01, plastic, 72 tags, 6x12 mm

060.72