

# Syr-line TMR48D

## Digital Timer

### Front Panel 48x48 (1/16 DIN)

- › Large LED or LCD Screen (13.2 mm)
- › Multi-function and single-function
- › Basic & Advance configuration modes
- › Multi-range (0.05 s – 9999 h)
- › Multi-voltage (24-240 V AC/DC)
- › 1 or 2 relay outputs (Changeover)
- › Memory option in event of a break in supply
- › Lock function
- › Up or down timing
- › DIN Sized (48x48 mm) Housing
- › Compact body (63 mm long)
- › Water & Dust-proof (IP66)
- › 8-Pins & 11-Pins connections



Standard Version  
(MDE1)



Performance Version  
(MDA2, MDF1, GDF1, GDS2)

## Product Selection

Type	Part Number	Function	Connections	Output	Supply Voltage	Screen
MDE1	MDE1R0524U	A, B, C, H, D, Di	8-Pins	1 x 5A	24 V AC/DC	LCD
MDE1	MDE1R05MVA	A, B, C, H, D, Di	8-Pins	1 x 5A	100-240 V AC/DC	LCD
MDA2	MDA2R10MV2	A	8-Pins	2 x 10A	24-240 V AC/DC	LED
MDF1	MDF1R10MV2	A, Ac, Ad, B, C, H, L, Li, D, Di	8-Pins	1 x 10A	24-240 V AC/DC	LED
GDF1	GDF1R10MV2	A, Ac, Ad, B, C, H, L, Li, D, Di	11-Pins	1 x 10A	24-240 V AC/DC	LED
GDS2	GDS2R10MV2	A, Ab, Ac, Ad, AMt, At, B, C, H, Ht, L, Li, T, W, D, Di	11-Pins	2 x 10A	24-240 V AC/DC	LED

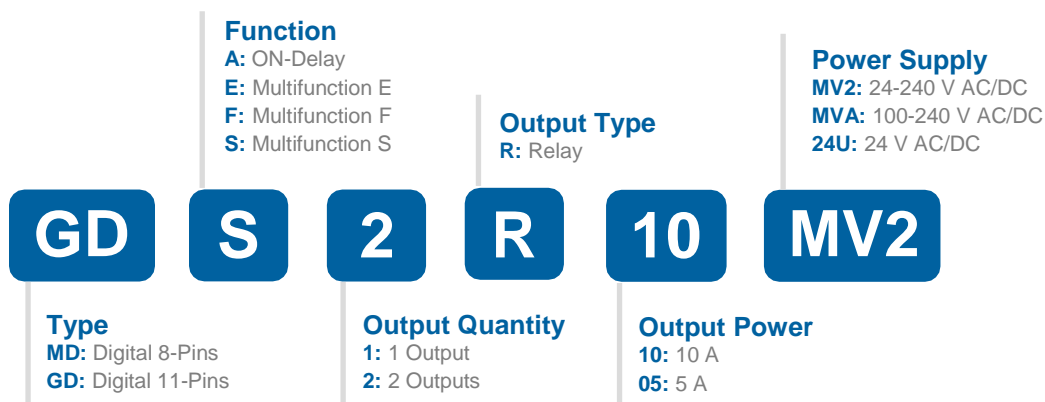

## Description:

The new Syr-line Digital Timers has higher precision and many programming features with the biggest screen ever seen in the timer relays' market and the most intuitive programming for ease to use and fast configuration

For more information about the Syr-line TMR48D Digital Timer please visit [www.crouzet.com](http://www.crouzet.com).

## Input Specifications

Description	MDE1...24U	MDE1...MVA	GDF1	MDF1	MDA2	GDS2
Rated supply voltage Un	24 V AC/DC	100-240 V AC/DC	24-240 V AC/DC	24-240 V AC/DC	24-240 V AC/DC	24-240 V AC/DC
Voltage supply tolerance	-15 % +10 %					
AC supply voltage frequency	50 / 60 Hz +/- 5%					
Galvanic isolation of supply / inputs	10					
Max power consumption @ Un	2.5 VA (VAC) 1 W (VDC)					
Immunity to power micro cuts	10 ms					

## Timing Specifications

Description	MDE1...24U	MDE1...MVA	GDF1	MDF1	MDA2	GDS2
Specified time ranges (10)	IEC 1812-1: 0.001 s to 9.999 s, 0.01 s to 99.99 s, 0.1 s to 999.9 s, 1 s to 9999 s, 1 s to 99 min 59 s, 0.1 min to 999.9 min, 1 min to 9999min, 1 n in to 99h 59 min, 0.1 h to 999.9 h, 1 h to 9999 h					
Minimum control pulse duration	IEC 1812-1: 1 ms or 20 ms select able					
Recovery time (after by de-energization)	IEC 1812-1: 120 ms Max					
Repeatability	IEC 1812-1: $\leq \pm 0.03 \% \pm 20 \text{ ms (VDC) / } 50 \text{ ms (VAC)}$					
Setting Accuracy	IEC 1812-1: $\leq \pm 0.03 \% \pm 20 \text{ ms (VDC) / } 50 \text{ ms (VAC)}$					
Temperature drift	$\leq \pm 0.03 \% \pm 20 \text{ ms (VDC) / } 50 \text{ ms (VAC)}$					
Voltage drift	$\leq \pm 0.03 \% \pm 20 \text{ ms (VDC) / } 50 \text{ ms (VAC)}$					

## Output Specifications

Description	MDE1...24U	MDE1...MVA	GDF1	MDF1	MDA2	GDS2
Contact arrangement	1 CO (SPDT)		1 CO (SPDT)		2 CO (SPDT)	
Maximum switching voltage	250 VAC / 30 VDC		250 VAC / 10 A resistive / 125 VDC / 0.3 A resistive		250 VAC / 10 A resistive / 125 VDC / 0.3 A resistive	
Switching current rate (resistive)	NO: 5A 250 VAC / 5 A 30 VDC - NC: 3A 250 VAC / 3 A 30 VDC		NO / NC: 10 A 250 VAC / 10 A 30 VDC		NO/NC: 2x10 A @ 40 °C 250 V AC / 2x10 A @ 40 °C 30 VDC NO / NC: 2x8 A @ 60 °C 250 V AC / 2x8A @ 60 °C 30 VDC	
Maximum switching power (resistive)	NO: 1250 VA / 150 W – NC: 750 VA / 90 W		2500 VA / 300 W		2 x 2500 VA / 2 x 300 W	
Electrical life at nominal switching current rate (resistive)	1x10 <sup>5</sup> cycles NO 7x10 <sup>4</sup> cycles NC		1x10 <sup>5</sup> cycles (10 A 250 VAC resistive)		1x10 <sup>5</sup> cycles (10 A 250 VAC resistive)	
Minimum switching contact	10 mA / 12 VDC					
Maximum rate (at max switching power)	360 cycles /hour					
Mechanical life	10 x 10 <sup>6</sup> cycles					
Dielectric strength between open contacts	1 kV / 1 min / 1 mA / 50 Hz					

## Insulation Specifications

Description	MDE1...24U	MDE1...MVA	GDF1	MDF1	MDA2	GDS2
Rated Insulation voltage	IEC 60664-1: 300 V					
Insulation coordination	IEC 60664-1: Overvoltage category III; pollution degree 2					
Rated impulse voltage	IEC 60664-1: 4 kV (1.2/50 µs)					
Clearance / Creepage distances	IEC 60664-1: 3 mm / 3.2 mm					
Dielectric strength	EN-61812-1: 2.5 kV / 1 min / 1 mA / 50 Hz					
Insulation Resistance	NFC 93 050: > 500 MΩ / 250 VDC / 1min					

## General Specifications

Description	MDE1...24U	MDE1...MVA	GDF1	MDF1	MDA2	GDS2
Display	4 digits per value 7 segments LCD	4 digits per value 7 segments LCD	4 digits per value 7 segments LCD with backlight	4 digits per value 7 segments LCD with backlight	4 digits per value 7 segments LCD with backlight	4 digits per value 7 segments LCD with backlight
Memory backup	EEPROM (rewrite 1,000,000 times min, 40 years data hold min)					
Casing	48x48 mm (1/16 DIN)					
Mounting position	All positions					
Mounting	Mounting Front panel, by clip Mounting base-mounted on socket					
Housing material	UL94: enclosure plastic type V0					
Degree of protection (Front Face)	IEC 60529: IP66 with front panel seal					
Degree of protection (Housing)	IEC 60529: IP20					
Operating temperature	IEC 60068-2: -10 °C to +60 °C					
Storage temperature	IEC 60068-2: -30 °C to +70 °C					
Humidity	IEC 60068-2-30: 93 % without condensation					
Vibration resistance	IEC 60068-2-6: ±0.15 mm 10 Hz - 60 Hz 2 g 60 Hz - 150 Hz					
Shock resistance	IEC60068-2-27: 15 gn – 11 ms, 3 x 6 axis (Output non-energized) 5gn – 11 ms, 3 x 6 axis (Output energized)					
Drop to concrete floor	IEC 60068-2-32: Height: 0.75 m					
Weight	Approx. 105 g (150 g with packing)					

## Standards Specifications

Description	MDE1...24U	MDE1...MVA	GDF1	MDF1	MDA2	GDS2
EU Directives	2014/30/EU: EMC, 2014/35/EU: Low voltage					
Approvals / Marking	CE, cULus Listed Industrial Control Equipment					
Security standard	IEC 60664-1: Insulation coordination for equipment within low-voltage systems					
Conformity with environmental directives	2015/863/UE: RoHS 1907/2006: Reach 2012/19/UE: WEEE					
Product standard	IEC 61812-1: Specified time relays for industrial use UL 508 (60947-4-1): Industrial Control Equipment (NRNT- Industrial Control Switches)					
Immunity to electrostatic discharges	Level III Air +/-8 KV / Contact +/-6 KV					
Immunity to radiated, radio-frequency, electromagnetic field	IEC61000-4-3: Level III, 10 V/m (80 MHz to 1 GHz) 80% AM (1 kHz), 3 V/m (1.4 to 2 GHz) 80% AM (1 KHz), 1 V/m (2 to 2.7 GHz) 80% AM (1 KHz)					
Immunity to rapid transient bursts	IEC 61000-4-4: Level IV, direct +/-4 kV (power supply) / capacitive coupling clamp +/-2 KV, (command input and outputs)					
Immunity to shock waves on power supply	IEC 61000-4-5: Level III, line-to-earth +/-2 kV / line-to-line +/-1 kV					
Immunity to radiofrequency in common mode	IEC 61000-4-6: Level III, 10 Vrms (0,15 to 80 MHz) 80% AM (1 kHz)					
Immunity to voltage dips and breaks	IEC 61000-4-11: Industrial Class II, 0 % residual voltage during 1 cycle AC power ports, 70 % residual voltage during 25/30 cycles AC power ports, 0 % residual voltage, 250/300 cycles AC power ports. Residential: 0 % residual voltage during 10 cycle AC power ports, 40 % residual voltage during 10 cycles AC power ports, 70 % residual voltage during 10 cycles AC power ports, 0 % residual voltage, 250/300 cycles AC power ports					
AC/DC main port emissions	EN55022 / CISPR22 Class B EN 55011 / CISPR11 Class B, Group 1					
Radiated emissions	EN55022 / CISPR22 Class B EN 55011 / CISPR11 Class B, Group 1					

## Accessories

<p><b>Socket for DIN Rail or Panel Mount</b></p>  <p>Plug-In 8-Pins</p> <p>25 622 130</p>	<p><b>Socket for DIN Rail or Panel Mount</b></p>  <p>Plug-In 11-Pins</p> <p>25 622 080</p>	<p><b>Socket with Screw Terminal</b></p>  <p>Plug-In 8-Pins</p> <p>25 622 203</p>
<p><b>Solder Plug</b></p>  <p>Plug-In 8-Pins</p> <p>25 622 301</p>	<p><b>Solder Plug</b></p>  <p>Plug-In 11-Pins</p> <p>25 622 076</p>	<p><b>Socket with Screw Terminal</b></p>  <p>Plug-In 11-Pins</p> <p>79 694 002</p>

### Dimensions in(mm)

#### Connector socket

11-pin 25622080 / 8-pin 25622130

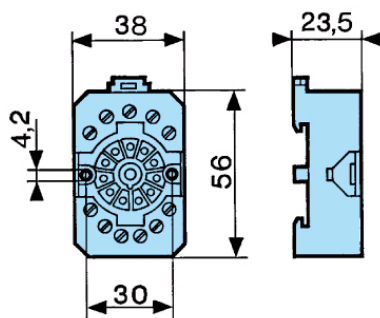

79694002: Panel-mounted

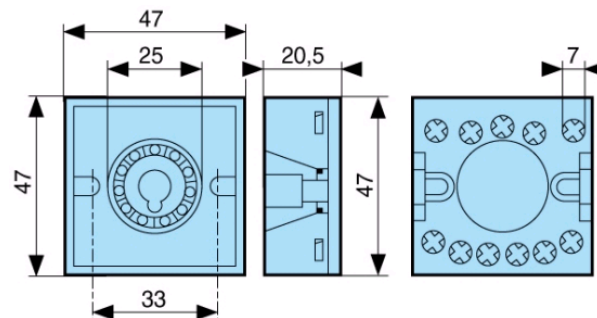

Solder-connected plug:  
25622301: 8 pin / 25622076: 11 pin

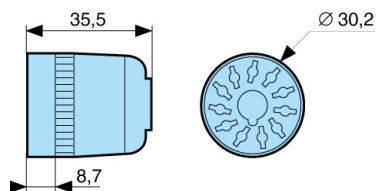

# Diagrams

## Wiring Diagrams

MDE1...24U

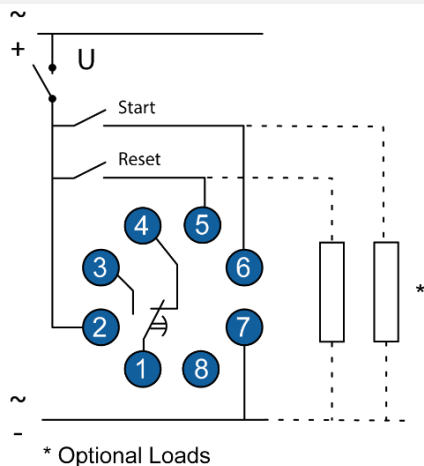

MDE1...MVA

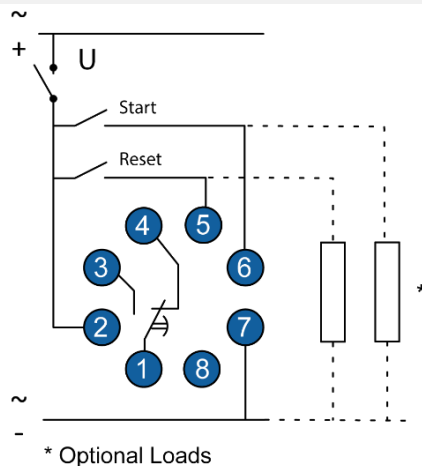

MDF1

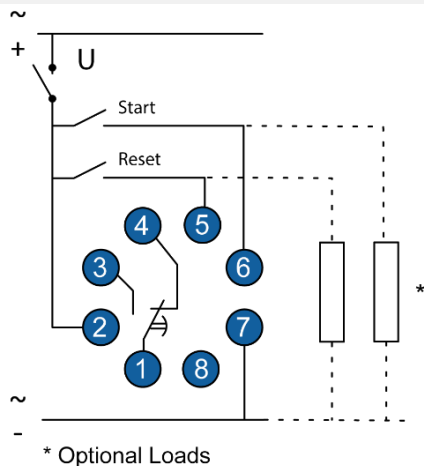

GDF1

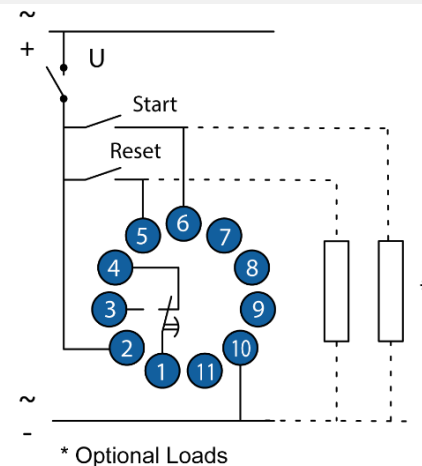

MDA2

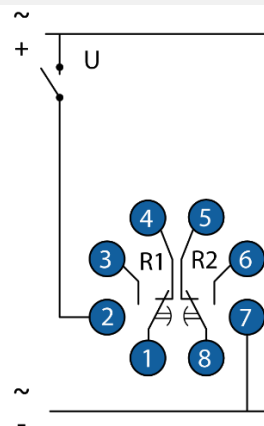

GDS2

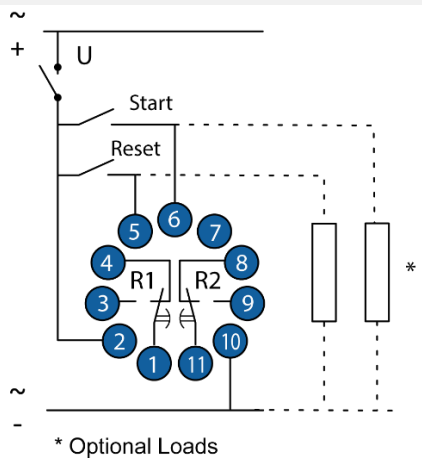

Dimensions in(mm)

Side View

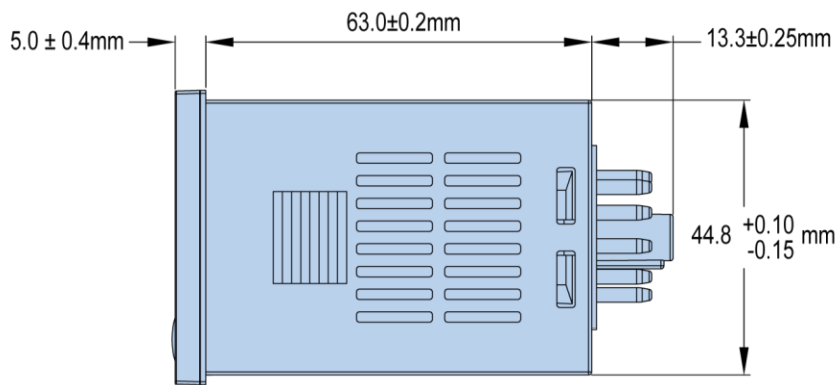

Front View

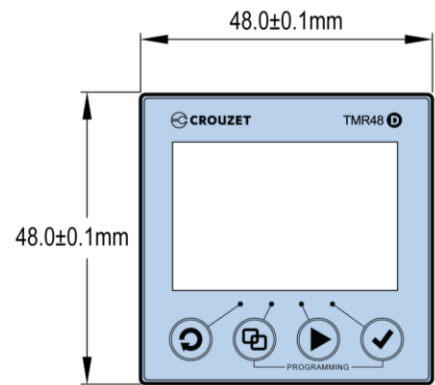

Mounting

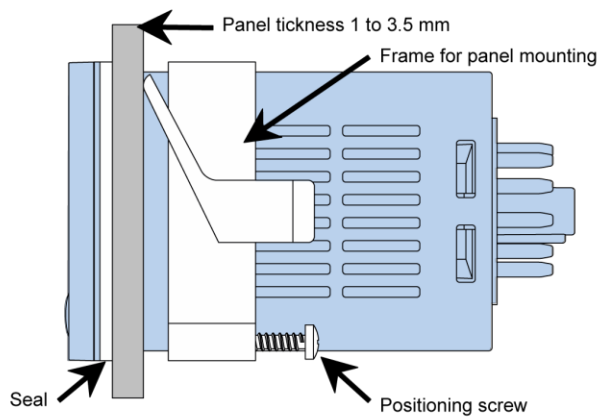

Panel Cut-Out

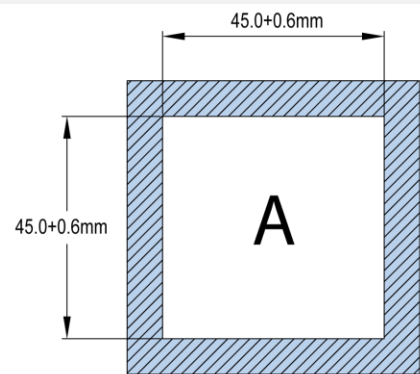

Basic Time Chart

Detailed Time Chart

FUNCTION A: On-Delay (Delay on make)

A

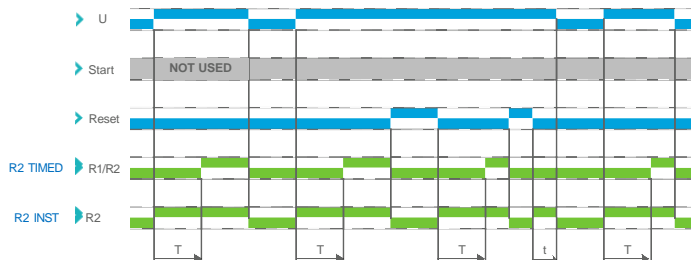
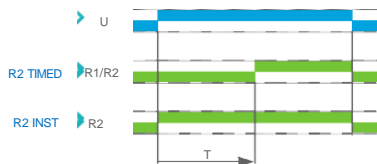

FUNCTION A + Memory Option

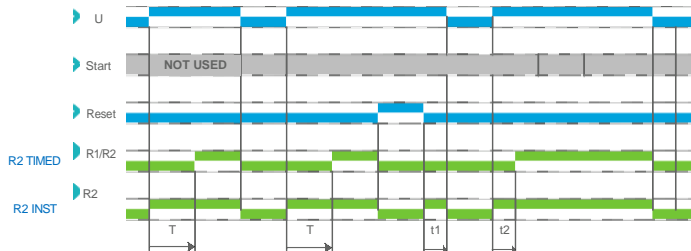
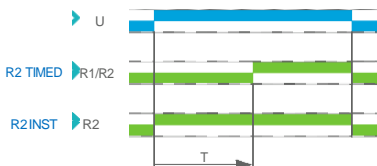

FUNCTION Ab: Delayed Interval

Ab

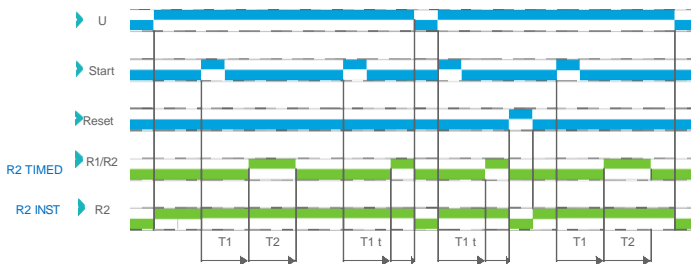
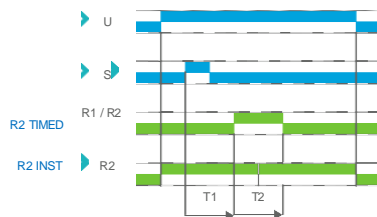

FUNCTION Ab + Memory Option

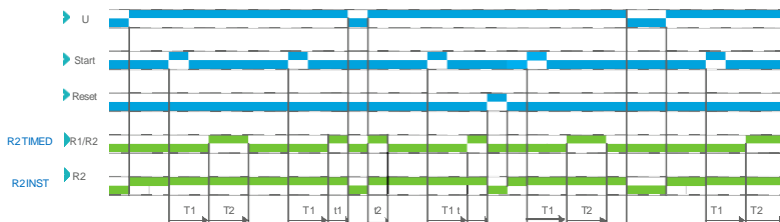
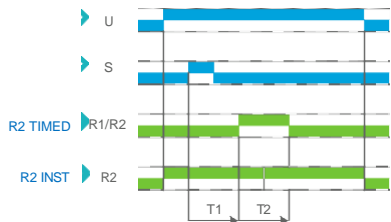

FUNCTION Ac: On/Off Delay (Delay on make/break)

Ac

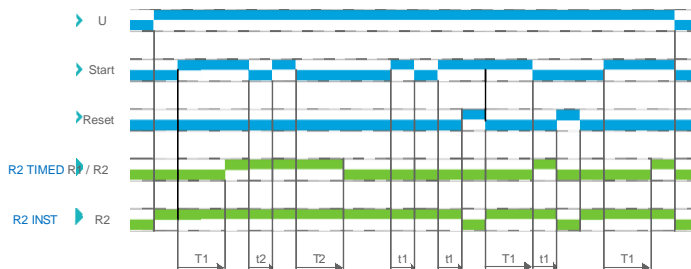
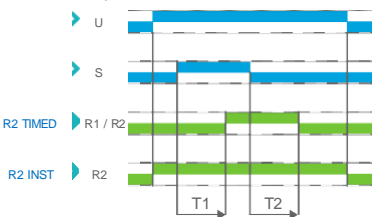



FUNCTION Ac + Memory Option

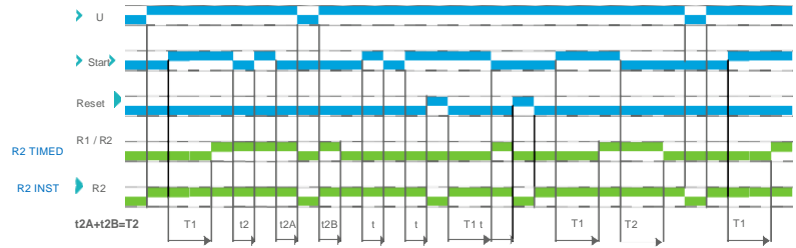
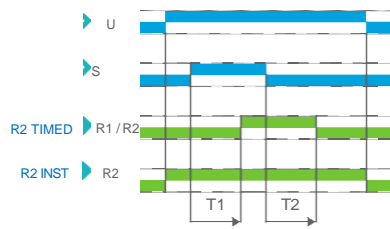

FUNCTION Ad: Delay on Start

Ad

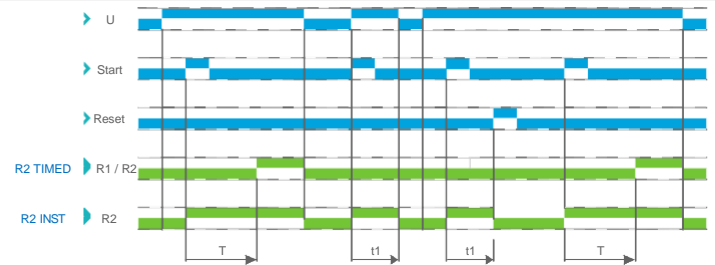
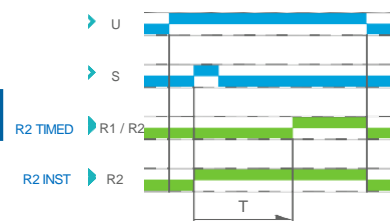

FUNCTION Ad + Memory Option

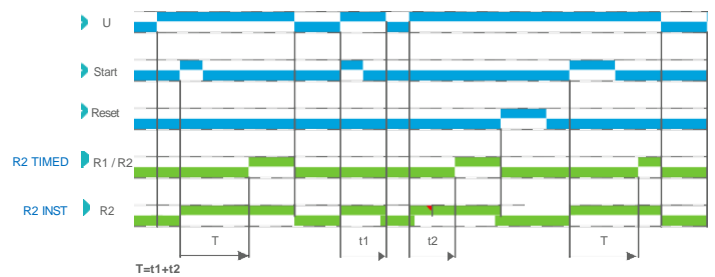
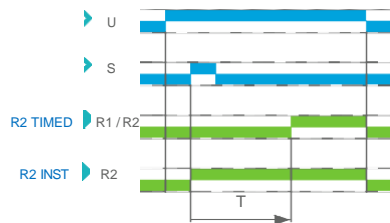

FUNCTION At: Summation Time Relay

At

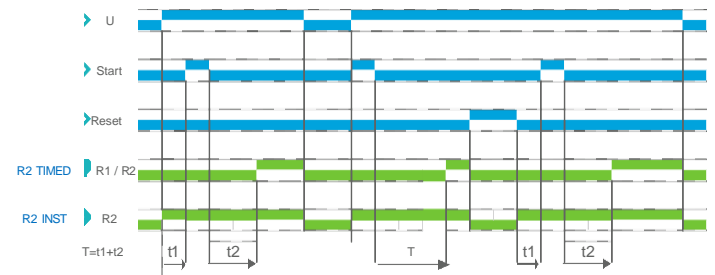
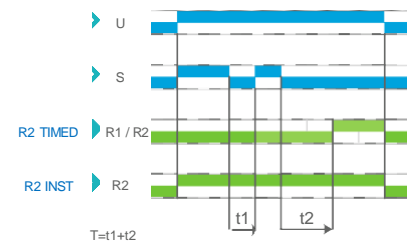

FUNCTION At + Memory Option

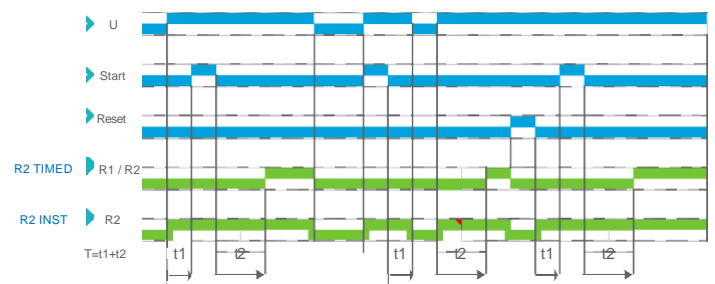
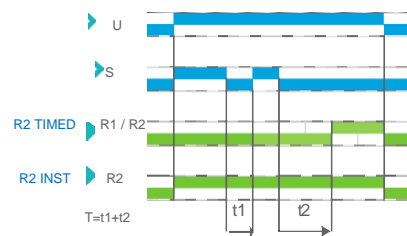

FUNCTION AMt: On-Delay (Delay on make, Total memory: one delay)

AMt

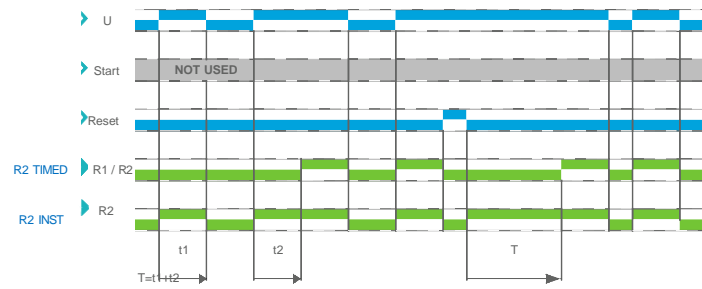
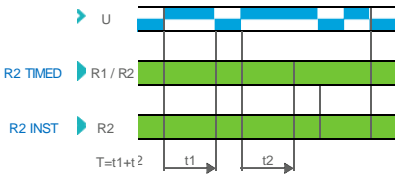

FUNCTION B: One-Shot

B

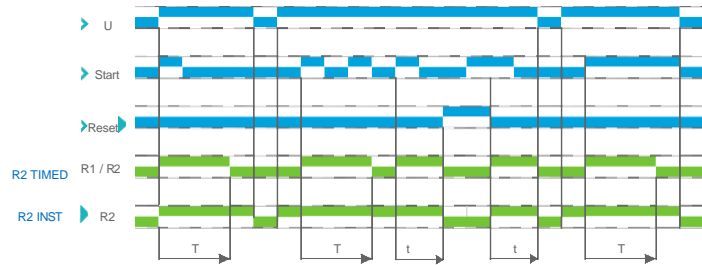
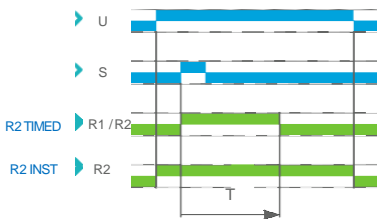

FUNCTION B + Memory Option

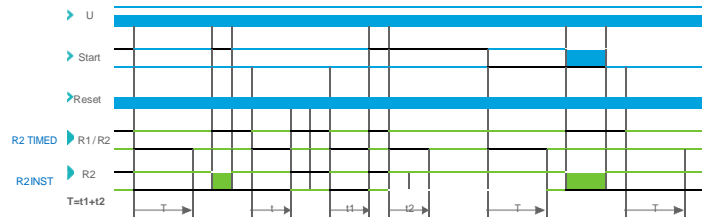
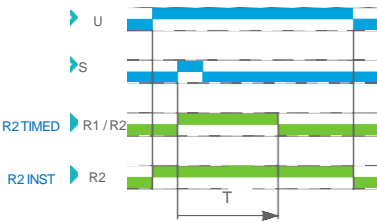

FUNCTION C: Off-Delay (Delay on break)

C

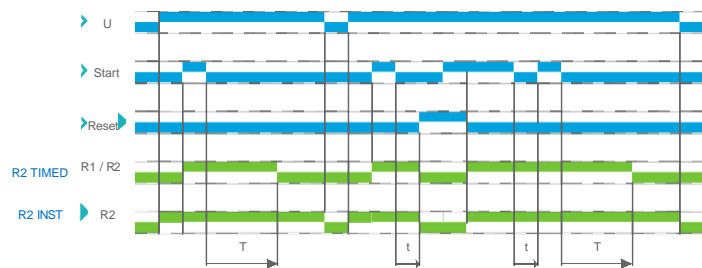
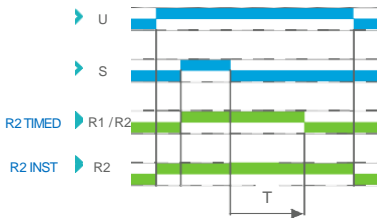

FUNCTION C + Memory Option

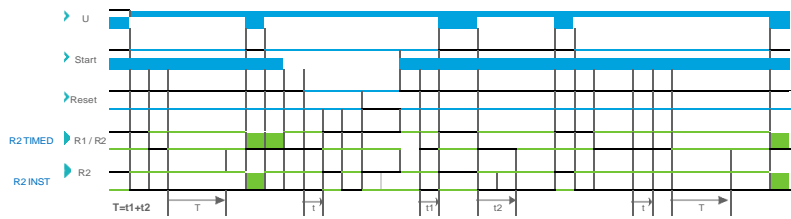
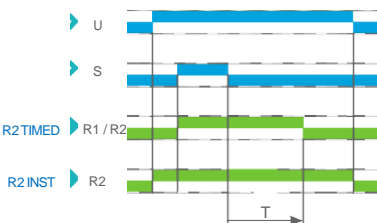

FUNCTION H: Interval

H

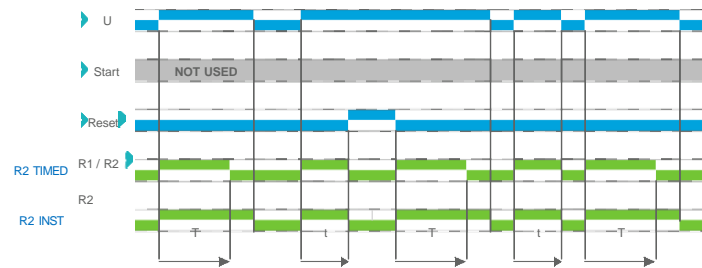
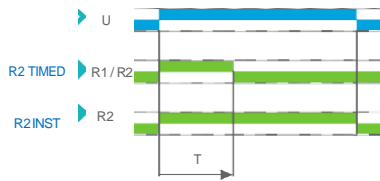

FUNCTION H + Memory Option

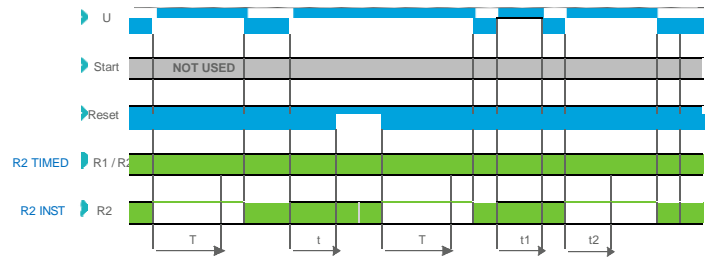
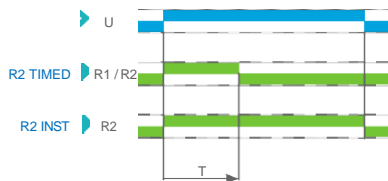

FUNCTION Ht: interval summation time relay

Ht

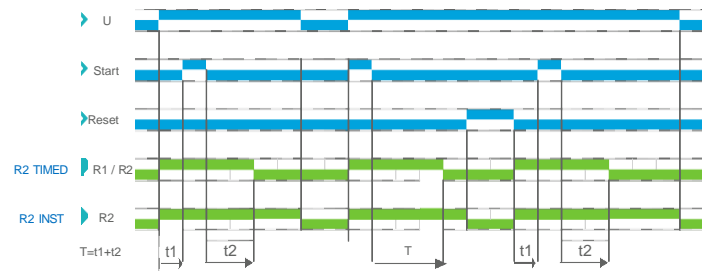
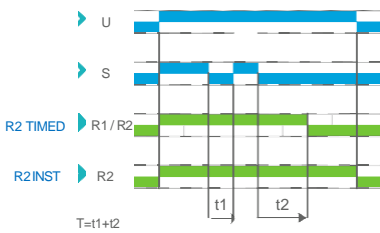

FUNCTION Ht + Memory Option

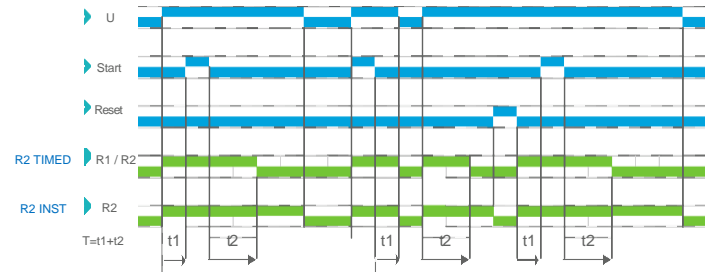
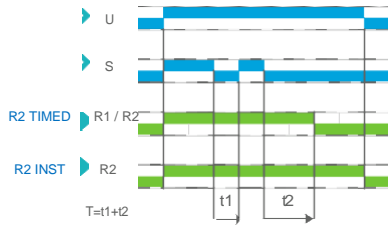

FUNCTION L: Recycler (OFF Start)

L

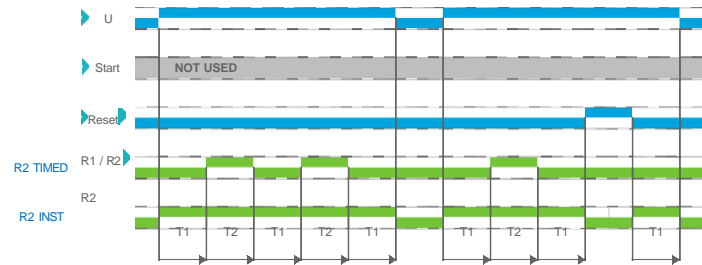
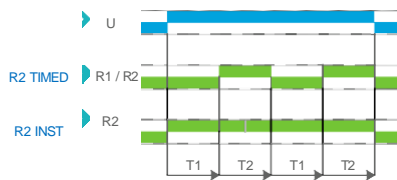

### FUNCTION L + Memory Option

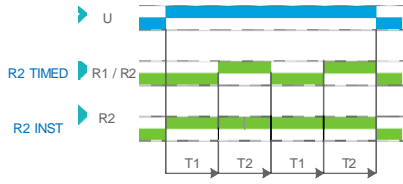

### FUNCTION Li: Recycler (ON Start)

Li

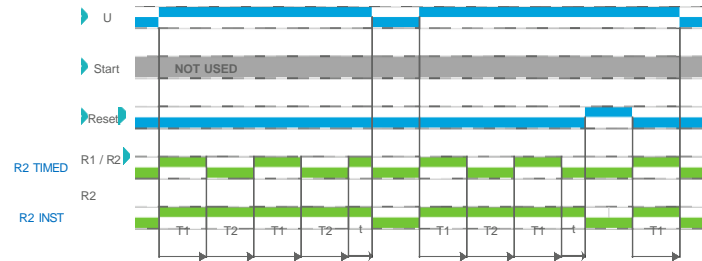
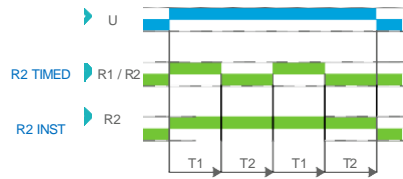

### FUNCTION Li + Memory Option

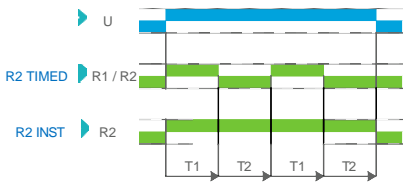

### FUNCTION T: On-Delay (Delay on make): sum of times

T

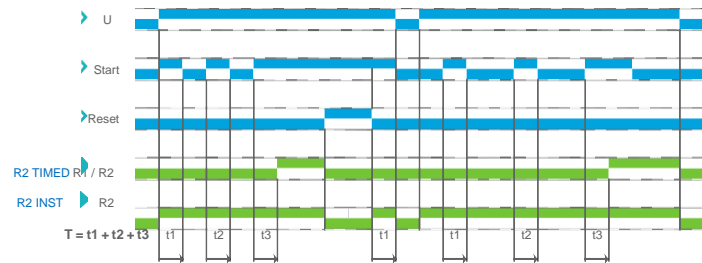
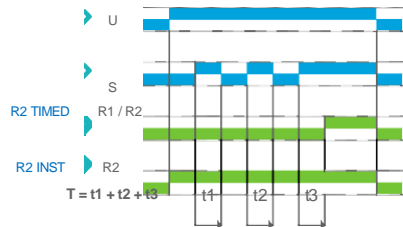

### FUNCTION T + Memory Option

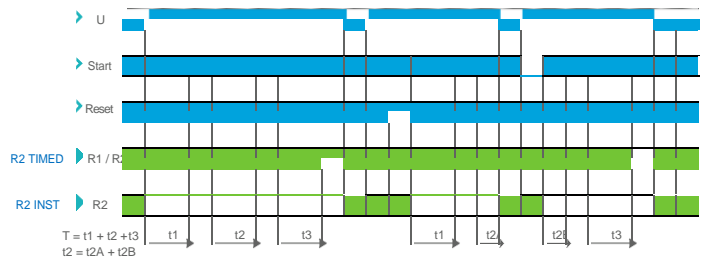
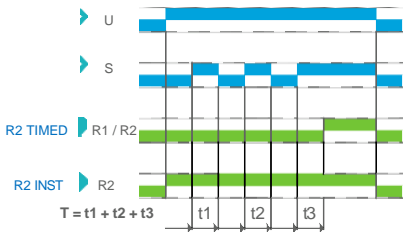

FUNCTION W: Timing after pulse of control contact

W

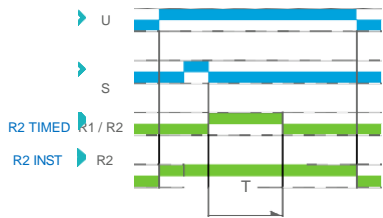

FUNCTION W + Memory Option

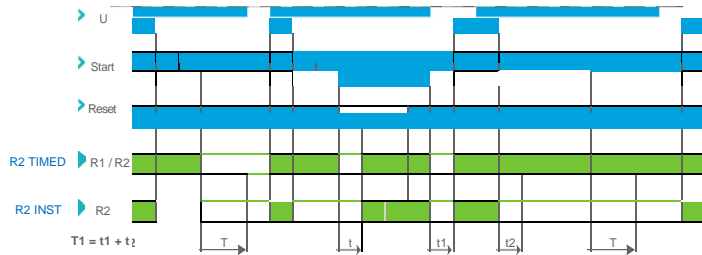
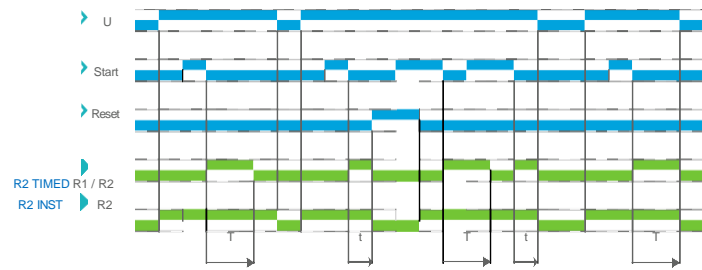
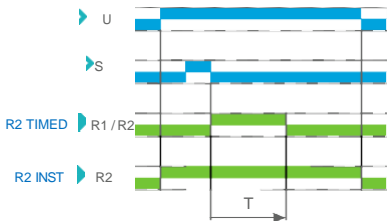

FUNCTION D: Symmetrical flashing (OFF start)

D

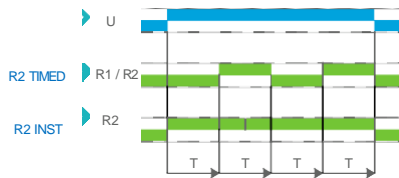

FUNCTION D + Memory Option

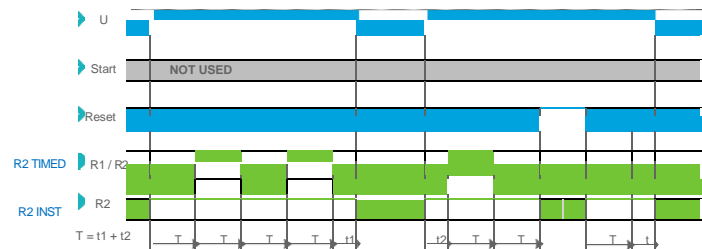
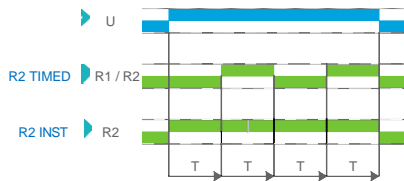

FUNCTION Di: Symmetrical flashing (ON start)

Di

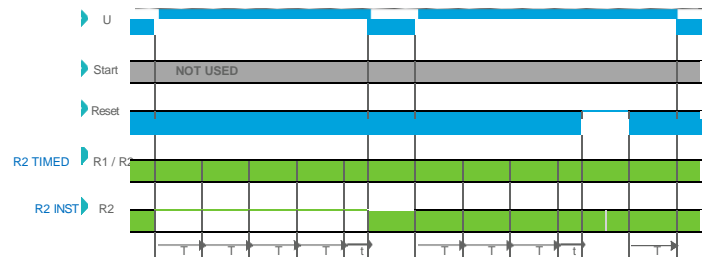
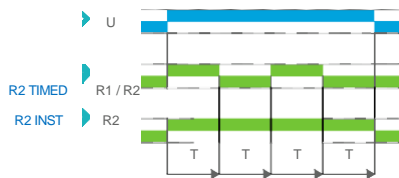

FUNCTION Di + Memory Option

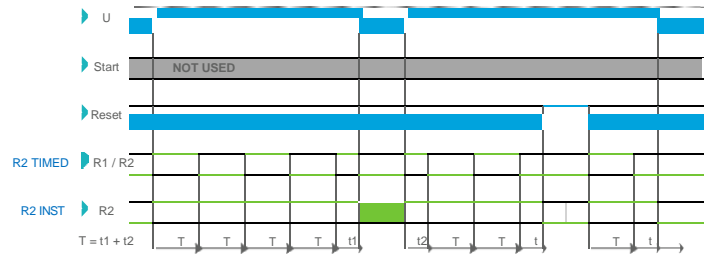
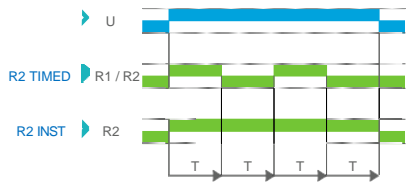

Keys Function

Set Time

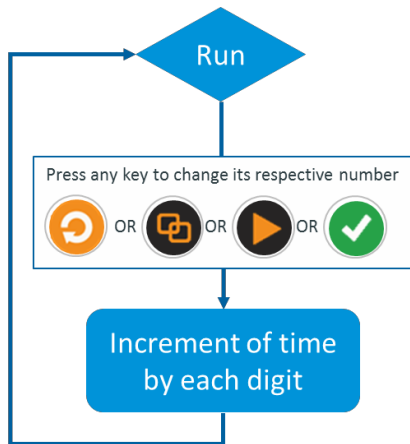

Check Configured Time and Function

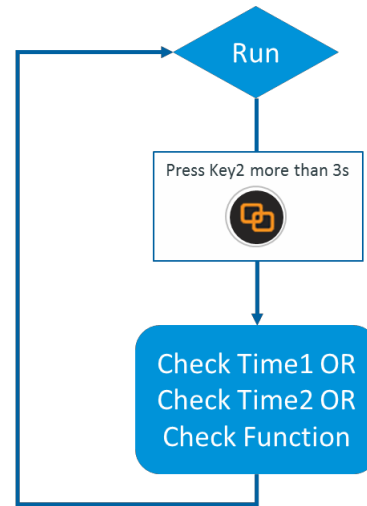

Reset Time

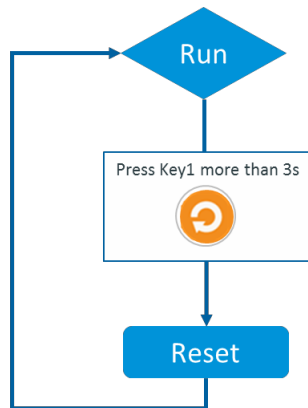

Programming Mode

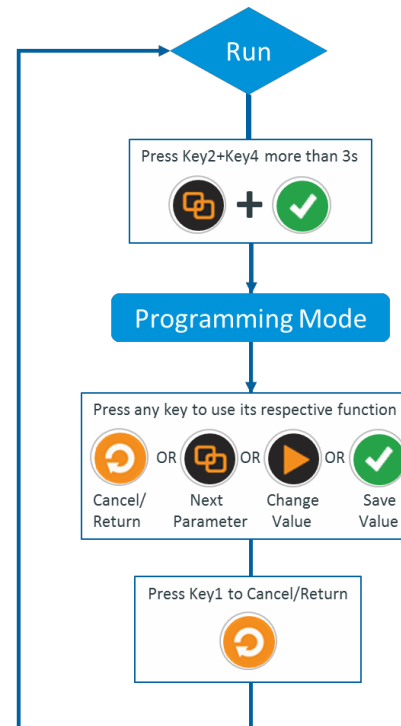

## Programming Mode

Programming Main Menu		
#	Parameter	Value
1	<b>PASS</b> Pass If "Lock" function is on, pass needs to be entered	0000 0000
2	<b>bASIC_ProG</b> Basic Prog Enter to Basic Programming Mode	
3	<b>ADVANCED_ProG</b> Advanced Prog Enter to Advanced Programming Mode	
4	<b>tEST</b> Test Enter to Test Mode	

Basic Prog Menu		
#	Parameter	Value
1	<b>FUncti on</b> Function Select the timing function	A Ab AC Ad ANt At b C A Ab Ac Ad AMt At B C H Ht L Li d di t ũ H Ht L Li D Di T W
2	<b>tI NE_rAnGE</b> Time Range Select the timing range	-.---s ---.---s ---.---s ---s ---m---s -.-s --.-s ---s ---s --m--s ---.---m ---m ---h---m ---.---h ---h ---.---m ---m --h--m ---.---h ---h
3	<b>CoUnt</b> Count Select the timing count up or down	UP Down Up Down
4	<b>MEmory</b> Memory Activate memory option (save timing after power off)	off on Off On
5	<b>oUtPUt_2</b> Output 2 Select if Out 2 works timed or instantaneous (MDA2, GDS2)	tI NE i nSt Timed Instantaneous

Advanced Prog Menu		
#	Parameter	Value
1	<b>i nPUt_tYPE</b> Input Type Select input to work with a NPN or PNP signal	P nP n P n PNP NPN
2	<b>tI NE_cHAnGE</b> Time Change Select if a timing change will be applied during current cycle (Now) or at the end of it (End)	no ũ End Now End
3	<b>tI NE_Li mIt</b> Time Limit Select upper time limit	9999 0000 9999 0000

4	<b>BRIGHTNESS</b> Brightness Select screen brightness	100 100%	50 50%			
5	<b>SLEEP AFTER</b> Sleep After Select the time needed to turn off the screen	OFF Off	5 s 5s	10 s 10s	30 s 30s	60 s 60s
6	<b>LOCK</b> Lock Select security level 1 (lock configuration) or 2 (lock all)	OFF Off	1 1	2 2		
6.1	<b>PASS</b> Pass Set password for lock option	0000 0000				
6.2	<b>DONE</b> Done Indication that the lock is on					
7	<b>DEFAULT SETTINGS</b> Default Settings Reset settings to default values	NO No	YES Yes			
7.1	<b>SURE</b> Sure Confirm if reset settings to default values	NO No	YES Yes			
7.2	<b>DONE</b> Done Indication that settings have been reset					

Test Mode Menu						
#	Parameter	Value				
1	<b>OUT 1</b> Out 1 Turn on/off Relay Output 1	OFF Off	ON On			
2	<b>OUT 2</b> Out 2 Turn on/off Relay Output 2 (MDA2, GDS2)	OFF Off	ON On			
3	<b>DISPLAY</b> Display Turn on/off all display segments	OFF Off	ON On			
4	<b>MEMORY</b> Memory Test the memory of the timer	OFF Off	TEST Test			
4.1	<b>Good</b> Good Indication that the memory is working properly					
4.2	<b>Err.</b> Error Indication that the memory is not working properly					

All specifications in this document are subject to change without written notice. Actual product may differ from pictures provided in this document.