

# PIR15...T with time module COM3

## time relays



R15 - 3 CO  
+ GZP11 + COM3

- Time relay **PIR15 - 3 CO (standard)** consists of: electromagnetic relay **R15 - 3 CO**, black plug-in socket **GZP11**, time module **COM3**, spring wire clip **GZP-0054**, white description plate **GZP-0035**
- Time relay **PIR15 - 2 CO** consists of: electromagnetic relay **R15 - 2 CO**, black plug-in socket **GZP8**, time module **COM3**, spring wire clip **GZP-0054**, white description plate **GZP-0035**
- 35 mm rail mount acc. to PN-EN 60715 or on panel mounting with two M3 screws • Recognitions, certifications, directives: recognitions R15, RoHS,

### Output circuits - contact data

Number and type of contacts	2 CO, 3 CO	
Contact material	<b>AgNi</b>	
Max. switching voltage	440 V AC / 250 V DC	
Rated load (capacity)	AC1	10 A / 250 V AC
	AC15	3 A / 120 V    1,5 A / 240 V (B300)
	AC3	370 W (single-phase motor; 0,5 HP / 240 V AC UL 508)
	DC1	10 A / 24 V DC (see Fig. 3)
	DC13	0,22 A / 120 V    0,1 A / 250 V (R300)
Max. inrush current	20 A	
Rated current	10 A	
Max. breaking capacity	AC1	2 500 VA
Min. breaking capacity	0,3 W    5 V, 5 mA	
Contact resistance	≤ 100 mΩ	
Max. operating frequency		
• at rated load	AC1	1 200 cycles/hour
• no load	12 000 cycles/hour	
<b>Input circuit</b>		
Rated voltage of output relay R15	50/60 Hz AC	24 ... 240 V
	DC	24 ... 220 V
Supply voltage of time module COM3	24 ... 240 V AC/DC (universal module)	
Operating range of supply voltage	0,85...1,1 U <sub>n</sub> see Tables 1, 2	
Rated power consumption	AC	3,0 VA
	DC	2,0 W
Range of supply frequency	48...63 Hz	
<b>Control contact (B1) S ①</b>		
• min. time of pulse duration ②	100 ms	
<b>Insulation according to PN-EN 60664-1</b>		
Insulation rated voltage	250 V AC	
Overvoltage category	III	
Dielectric strength		
• input - outputs	2 500 V AC	type of insulation: basic
• contact clearance	1 500 V AC	type of clearance: micro-disconnection
• pole - pole	2 000 V AC	type of insulation: basic
Input - outputs distance		
• clearance	≥ 3 mm	
• creepage	≥ 4,2 mm	
<b>General data</b>		
Operating / release time (typical values)	AC: 12 ms / 10 ms	DC: 18 ms / 7 ms
Electrical life		
• resistive AC1	> 2 x 10 <sup>5</sup> 10 A, 250 V AC	
• cosφ	patrz Wykres 2	
Mechanical life (cycles)	> 2 x 10 <sup>7</sup>	
Dimensions (L x W x H)	73 x 38,2 x 85,4 mm	
Weight	3 CO: 175 g	2 CO: 168 g
Ambient temperature	• storage	-40...+70 °C
	• operating	-40...+55 °C
Cover protection category	IP 20	PN-EN 60529
Environmental protection	R15: RTI    GZP11, GZP8: RT0	PN-EN 116000-3
Shock resistance	10 g	
Vibration resistance	5 g 10...500 Hz	

The data in bold type pertain to the standard versions of the relays.

① The control terminal B1 is activated by connection to A1 terminal via the external control contact S.

② Where the control signal is recognizable.

# PIR15...T with time module COM3

## time relays

### Time module data

Functions	E, Wu, Bp, Bi, R, Ws, Wa, Es
Function adjustment ④	selection with microswitches
Time ranges	1 s; 10 s; 1 min.; 10 min.; 1 h; 10 h; 1 d; 10 d
Timing adjustment ④	(0,05...1) x time range - with microswitches; within the range - with a potentiometer
Base accuracy	± 1% (calculated from the final range values)
Setting accuracy	± 5% (calculated from the final range values)
Repeatability	± 0,5% or ± 5 ms
Temperature influence	± 0,01% / °C
Recovery time	150 ms
LED indicator	green LED U ON - indication of supply voltage U green LED U flashing - measurement of T time

④ Settings of switches - see below.

### Settings of switches

Function adjustment	E	Wu	Bi	Bp	R	Ws	Wa	Es
microswitches 1, 2, 3								
Timing adjustment (max.)	1 s	10 s	1 min.	10 min.	1 h	10 h	1 d	10 d
microswitches 4, 5, 6								

### Input data - DC voltage version

Table 1

Input voltage code	Rated input voltage $U_n$ V DC	Input resistance at 20 °C $\Omega$	Acceptable resistance	Input - voltage range V DC	
				min. (at 20 °C)	max. (at 55 °C)
<b>024DC</b>	<b>24</b>	<b>430</b>	<b>± 10%</b>	<b>19,2</b>	<b>26,4</b>
048DC	48	1 750	± 10%	38,4	52,8
060DC	60	2 700	± 10%	48,0	66,0
110DC	110	9 200	± 10%	88,0	121,0
120DC	120	11 000	± 10%	96,0	132,0
<b>220DC</b>	<b>220</b>	<b>37 000</b>	<b>± 10%</b>	<b>176,0</b>	<b>242,0</b>

The data in bold type pertain to the standard versions of the relays.

### Input data - AC 50/60 Hz voltage version

Table 2

Input voltage code	Rated input voltage $U_n$ V AC	Input resistance at 20 °C $\Omega$	Acceptable resistance	Input - voltage range V AC	
				min. (at 20 °C)	max. (at 55 °C)
<b>024AC</b>	<b>24</b>	<b>75</b>	<b>± 15%</b>	<b>19,2</b>	<b>26,4</b>
048AC	48	305	± 15%	38,4	52,8
060AC	60	475	± 15%	48,0	66,0
110AC	110	1 700	± 15%	88,0	121,0
120AC	120	1 910	± 15%	96,0	132,0
<b>230AC</b>	<b>230</b>	<b>7 080</b>	<b>± 15%</b>	<b>184,0</b>	<b>253,0</b>
240AC	240	7 760	± 15%	192,0	264,0

The data in bold type pertain to the standard versions of the relays.

14.07.2014

### Time functions

**E - ON delay.**

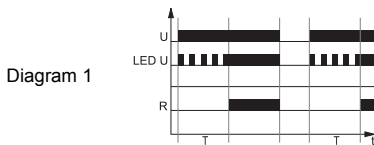

On applying the supply voltage U the set interval T begins - off-delay of the output relay R. After the interval T has lapsed, the output relay R switches on and remains on until supply voltage U is interrupted - see Diagram 1.

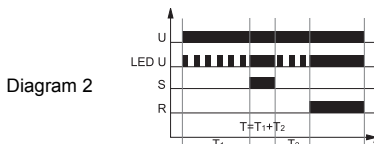

**Note:** in case the **control contact S is closed** in the course of the interval T, measurement of the interval T will be interrupted for the time in which the contact S is closed. Opening of the control contact S begins further measurement of the interval T. After the set interval T has lapsed, the output relay switches on and remains in this position until the supply voltage U is interrupted - see Diagram 2.

**Wu - ON for the set interval.**

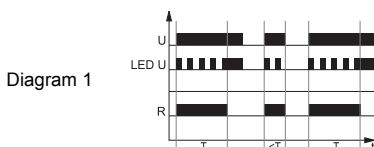

Applying the supply voltage U immediately switches the output relay R on for the set interval T. After the interval T has lapsed, the output relay R switches off - see Diagram 1.

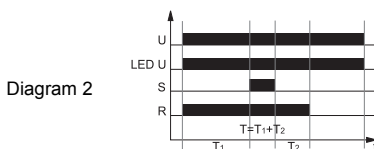

**Note:** if the **control contact S is closed** during the interval T, the interval is stopped for the time for which the control contact S remains closed. Opening of the control contact S restores the measurement of the interval T. After the interval T has lapsed, the output relay R switches off - see Diagram 2.

**Bp - Symmetrical cyclical operation pause first.**

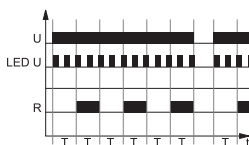

Applying the supply voltage U starts the cyclical operation from the T interval - switching the output relay R off followed by switching on the output relay R for the interval T. The cyclical operation lasts until the supply voltage U is interrupted.

**Bi - Symmetrical cyclical operation pulse first.**

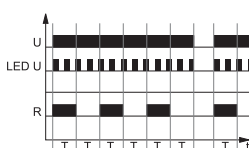

Applying the supply voltage U starts the cyclical operation from switching on the output relay R for the set interval T. After the interval T has lapsed,

the output relay R switches off for the interval T. The cyclical operation lasts until the supply voltage U is interrupted.

**R - OFF delay with the control contact S.**

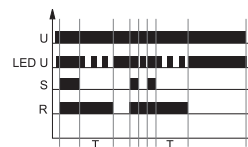

The input of the time relay is supplied with voltage U continuously. Closing of the control contact S immediately switches on the output relay R. Opening of the control contact S starts the set time of the delayed switching off of the output relay R. After the interval T has lapsed, the output relay R switches off. If the control contact S is closed during the interval T, the already measured time is reset, and the output relay R is switched on again. The OFF delay of the output relay R will start when the control contact S is opened again.

**Ws - Single shot for the set interval triggered by closing of the control contact S.**



The input of the time relay is supplied with voltage U continuously. Closing of the control contact S immediately switches the output relay R on for the set interval T. After the interval T has lapsed, the output relay R is switched off. In the course of the interval T, any opening of the control contact S does not affect the function to be performed. The output relay R may be switched on again for the set interval, after the interval T has lapsed, by closing the control contact S again.

**Wa - ON for the set interval triggered with the control contact S.**

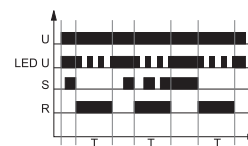

The input of the time relay is supplied with voltage U continuously. Closing of the control contact S does not start the interval T, and it does not change the position of the output relay R. Opening of the control contact S immediately switches on the output relay R for the set time. After the interval T has lapsed, the output relay R switches off. Opening and closing of the control contact S in the course of the interval T does not affect the function to be performed. The output relay R may be switched on again for the set interval with another closing and opening of the control contact S.

**Es - ON delay with the control contact S.**

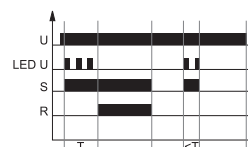

The input of the time relay is supplied with voltage U continuously. Closing of the control contact S starts the interval T - on-delay of the output relay R. After the interval T has lapsed, the output relay R switches on and remains in this position until the control contact S is opened. In case the control contact S is closed for time shorter than the set interval T, the output relay R will not activate.

U - supply voltage; R - output state of the relay; S - control contact state; T, T<sub>1</sub>, T<sub>2</sub> - measured times; t - time axis

# PIR15...T with time module COM3 time relays

## Dimensions

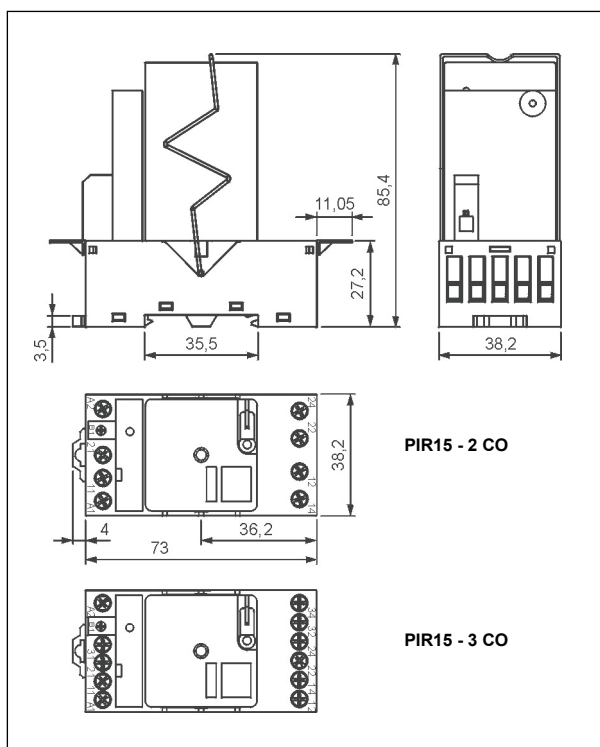

## Electrical life at AC resistive load. Switching frequency: 1 200 cycles/hour

Fig. 1

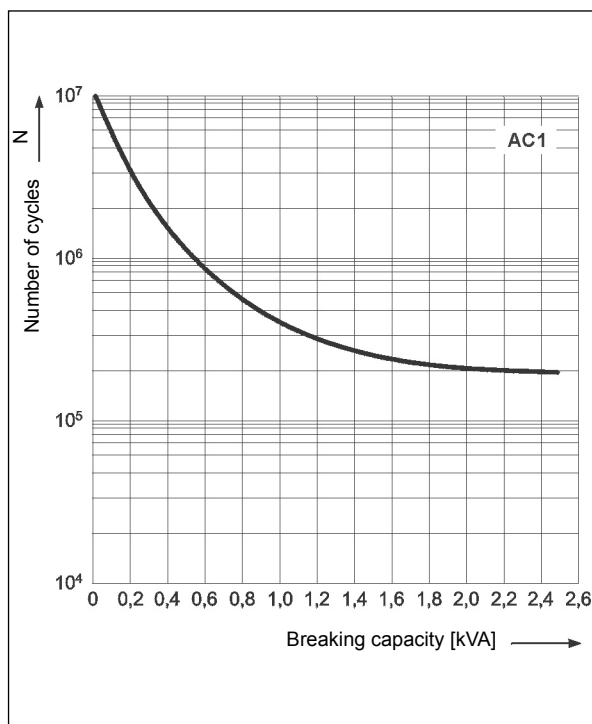

## Electrical life reduction factor at AC inductive load

Fig. 2

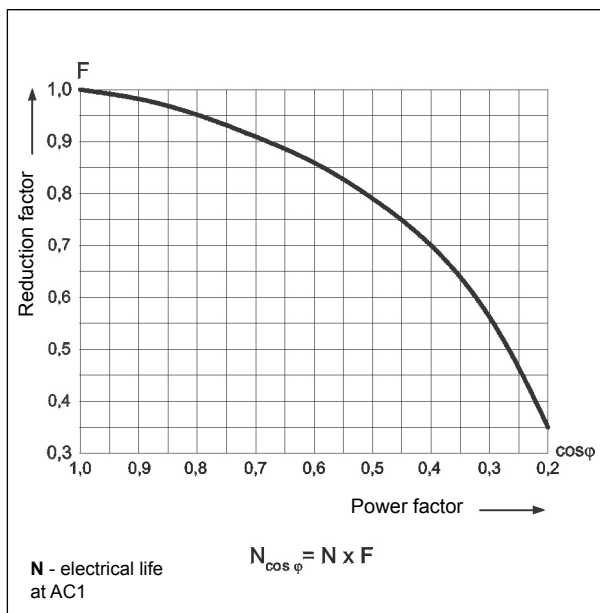

## Max. DC breaking capacity A - resistive load DC1 B - inductive load L/R = 40 ms

Fig. 3

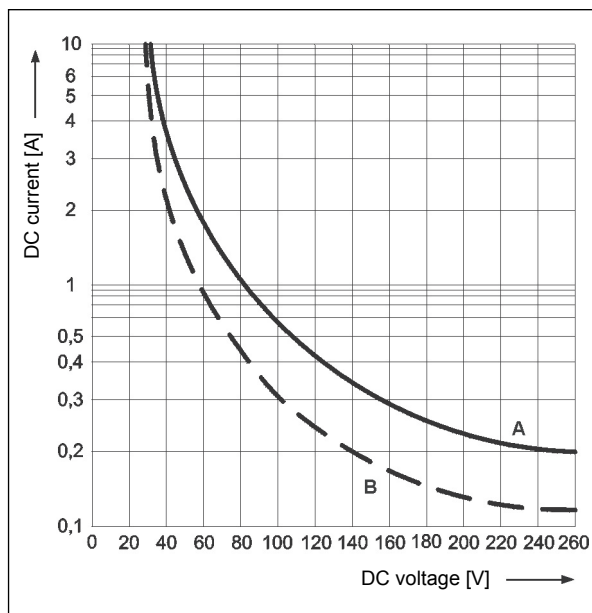

## Mounting

Relays PIR15...T are designed for direct mounting on 35 mm rail mount acc. to PN-EN 60715 or on panel mounting with two M3 screws. **Connections:** max. cross section of the cables (stranded):  $2 \times 2,5 \text{ mm}^2$  ( $2 \times 14 \text{ AWG}$ ), length of the cable deinsulation: 6,5 mm, max. tightening moment for the terminal: 0,5 Nm.

# PIR15...T with time module COM3 time relays

## Connection diagrams (screw terminals side view)

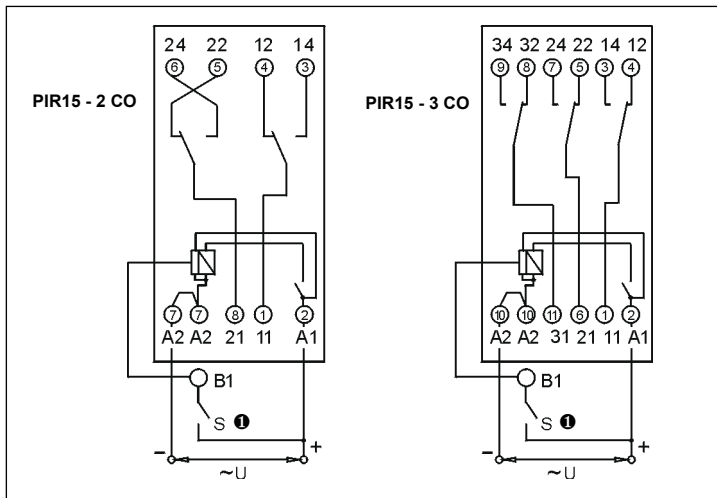

❶ The control terminal B1 is activated by connection to A1 terminal via the external control contact S.

## Dimensions - time module COM3

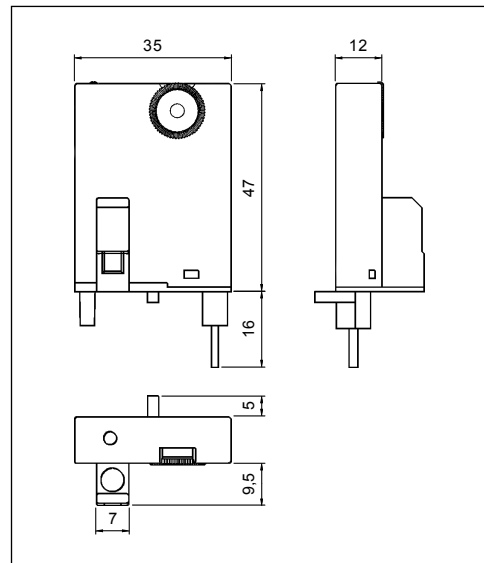

## Ordering codes

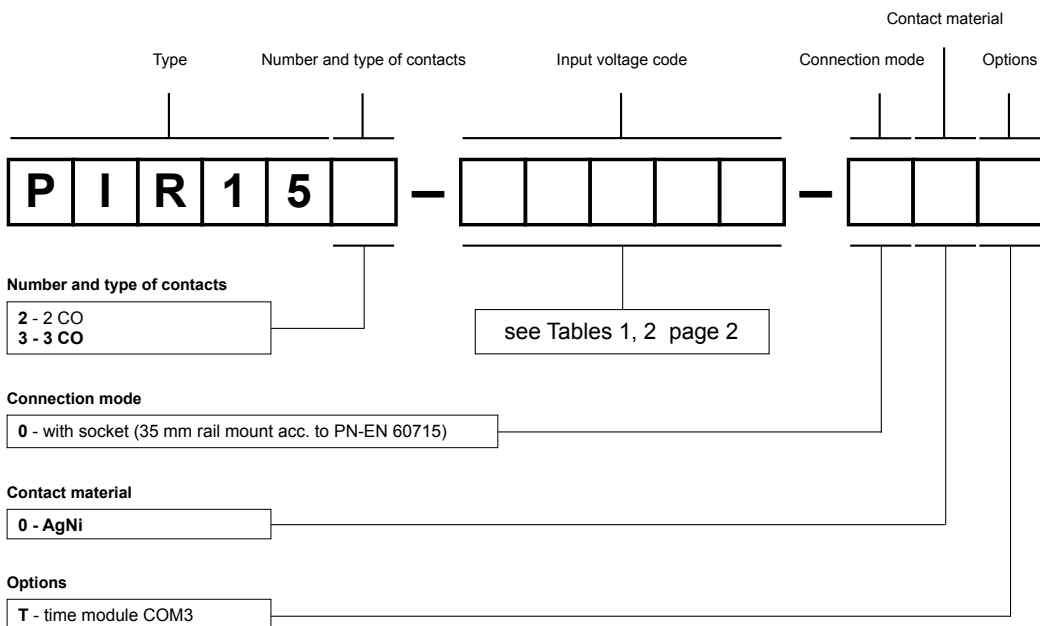

Examples of ordering codes:

**PIR153-230AC-00T** time relay **PIR15 - 3 CO**, which consists of: relay **R15 - 3 CO** (contact material AgNi, rated input voltage 230 V AC 50/60 Hz), black plug-in socket **GZP11** (screw terminals), time module **COM3**, spring wire clip **GZP-0054**, white description plate **GZP-0035**

**PIR152-024DC-00T** time relay **PIR15 - 2 CO**, which consists of: relay **R15 - 2 CO** (contact material AgNi, rated input voltage 24 V DC, black plug-in socket **GZP8** (screw terminals), time module **COM3**, spring wire clip **GZP-0054**, white description plate **GZP-0035**

### PRECAUTIONS:

1. Ensure that the parameters of the product described in its specification provide a safety margin for the appropriate operation of the device or system and never use the product in circumstances which exceed the parameters of the product. 2. Never touch any live parts of the device. 3. Ensure that the product has been connected correctly. An incorrect connection may cause malfunction, excessive heating or risk of fire. 4. In case of any risk of any serious material loss or death or injuries of humans or animals, the devices or systems shall be designed so to equip them with double safety system to guarantee their reliable operation.

## COM3

Universal time module  
- see [www.repol.com.pl](http://www.repol.com.pl)

