

Operating Instruction

1. Power off

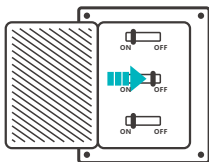

⚠ To avoid electric shocks, please consult the dealer or a qualified professional for help when installing and repairing! Please do not touch the switch during use.

2. Wiring instruction

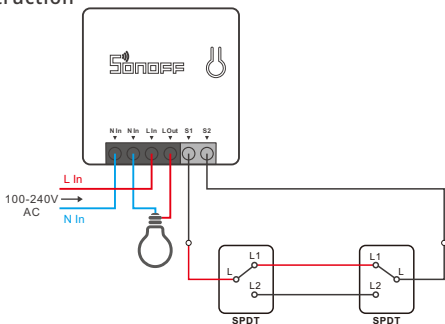

ⓘ Make sure the neutral wire and live wire connection is correct.

⚠ S1/S2 can connect with the rocker light switch or doesn't connect. To ensure safety, do not connect the neutral wire and live wire to it.

3. Download APP

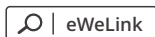

Android™ & iOS

4. Power on

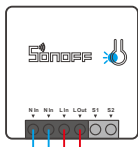

After powering on, the device will enter the quick pairing mode (Touch) during the first use. The Wi-Fi LED indicator changes in a cycle of two short and one long flash and release.

⚠ The device will exit the quick pairing mode (Touch) if not paired within 3mins. If you want to enter this mode, please long press the manual button for about 5s until the Wi-Fi LED indicator changes in a cycle of two short and one long flash and release.

5. Add the device

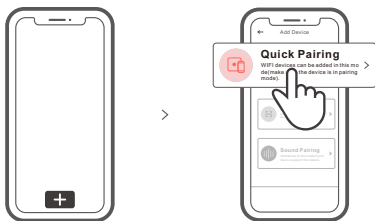

Tap "+" and select "Quick Pairing", then operate following the prompt on the APP.

Compatible Pairing Mode

If you fail to enter Quick Pairing Mode (Touch), please try "Compatible Pairing Mode" to pair.

- 1 Long press Pairing button for 5s until the Wi-Fi LED indicator changes in a cycle of two short flashes and one long flash and release. Long press Pairing button for 5s again until the Wi-Fi LED indicator flashes quickly. Then, the device enters Compatible Pairing Mode.
- 2 Tap "+" and select "Compatible Pairing Mode" on APP.

Select Wi-Fi SSID with ITEAD-***** and enter the password 12345678, and then go back to eWeLink APP and tap "Next". Be patient until pairing completes.

Specifications

Model	MINIR2
Input	100-240V AC 50/60Hz 10A Max
Output	100-240V AC 50/60Hz 10A Max
Operating systems	Android & iOS
Wi-Fi	IEEE 802.11 b/g/n 2.4GHz
Material	PC V0
Dimension	42.6x42.6x20mm

Product Introduction

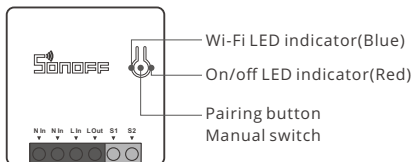

- ⚠ The device weight is less than 1 kg.
The installation height of less than 2 m is recommended.

Wi-Fi LED indicator status instruction

Wi-Fi LED indicator status	Status instruction
Flashes (one long and two short)	Quick Pairing Mode
Keeps on	Device is connected successfully
Flashes quickly	Compatible Pairing Mode
Flashes quickly once	Unable to discover the router
Flashes quickly twice	Connect to the router but fail to connect to Wi-Fi
Flashes quickly three times	Upgrading

Features

Turn on/off the device from anywhere, schedule power on/off and share APP with your family to control.



Remote Control

Single/Countdown
Timing

Voice Control



Share Control



Smart Scene



Sync Status



No Hub Required



Camera Linking



Power-on State



LAN Control

Switch Network

If you need to change the network, long press the pairing button for 5s until the Wi-Fi LED indicator changes in a cycle of two short and one long flash and release, then the device enters quick pairing mode and you can pair again.

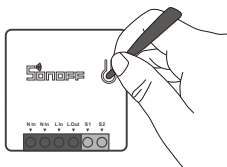

Factory Reset

Deleting the device on the eWeLink app indicates you restore it to factory setting.

Common Problems

Q: Why my device stays "Offline"?

A: The newly added device needs 1 – 2mins to connect Wi-Fi and network. If it stays offline for a long time, please judge these problems by the blue Wi-Fi indicator status:

1. The blue Wi-Fi indicator quickly flashes once per second, which means that the switch failed to connect your Wi-Fi:
 - ① Maybe you have entered a wrong Wi-Fi password.
 - ② Maybe there's too much distance between the switch your router or the environment causes interference, consider getting close to the router. If failed, please add it again.
 - ③ The 5G Wi-Fi network is not supported and only supports the 2.4GHz wireless network.
 - ④ Maybe the MAC address filtering is open. Please turn it off.

If none of the above methods solved the problem, you can open the mobile datanetwork on your phone to create a Wi-Fi hotspot, then add the device again.

2. Blue indicator quickly flashes twice per second, which means your device has connected to Wi-Fi but failed to connect to the server.
Ensure steady enough network. If double flash occurs frequently, which means you access an unsteady network, not a product problem. If the network is normal, try to turn off the power to restart the switch.