

Linkeo C

- Connecteurs
- Connectoren
- Connectors
- Stecker

- Conectores
- Conectores
- Złącza
- Разъёмы

• 连接头
• الموصلات

RJ 45 - Cat 5e - Cat 6 - Cat 6A



	UTP	FTP	STP
Cat 5e	6 329 11	-	6 329 10
Cat 6	6 329 09	6 329 08	6 329 07
Cat 6A	6 329 06	-	6 329 05

- Installation
- Installatie
- Installation
- Installation
- Instalación
- Instalação

- Instalacja
- Установка
- 安装
- التركيب

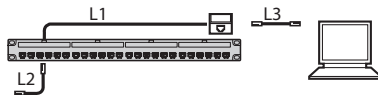

Cat 5e - Cat 6	L1 ≤ 90 m
	L2 ≤ 5 m
	L3 ≤ 5 m
Cat 6A	15 m ≤ L1 ≤ 90 m
	L2 ≤ 5 m
	L3 ≤ 5 m

- Câblage (AWG 23....26)
- Bekabeling (AWG 23....26)
- Cabling (AWG 23 to 26)
- Verdringung (AWG 23 bis 26)
- Cableado (AWG 23....26)
- Cablagem (AWG 23-26)
- Okablowanie (AWG 23....26)
- Прокладка проводов (AWG 23....26)
- 布线 (AWG 23...26)
- ربط الأسلاك (AWG 23...26)

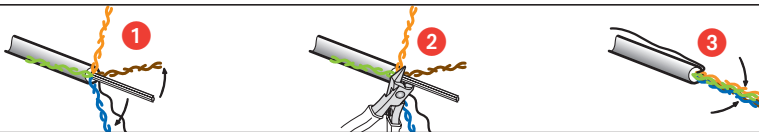
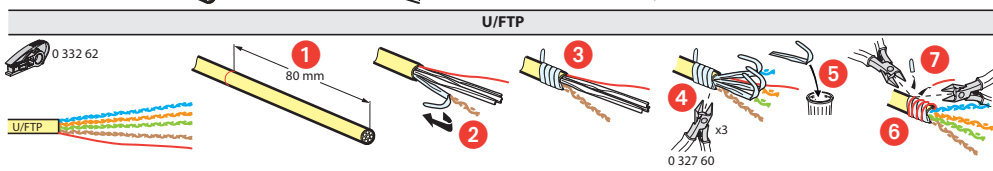
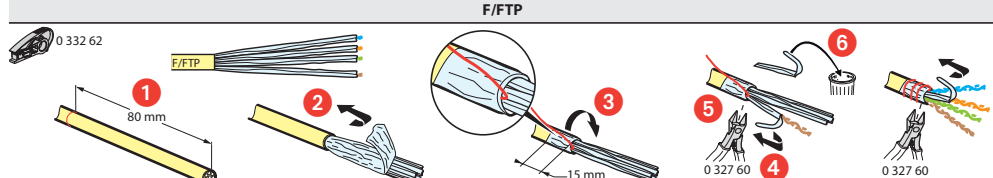
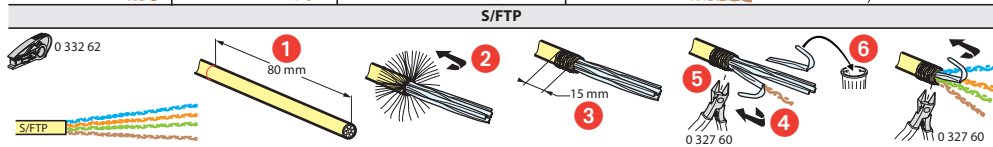
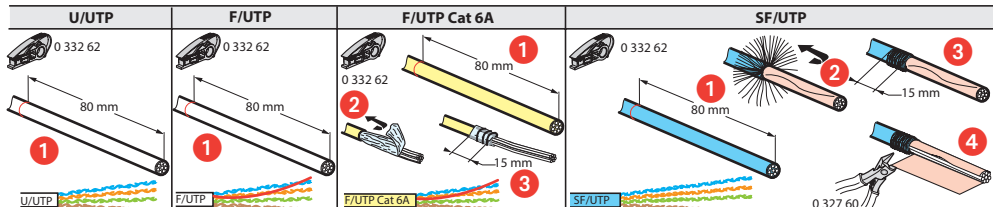

LE13273AA



T 568 A



T 568 B

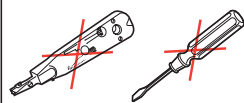
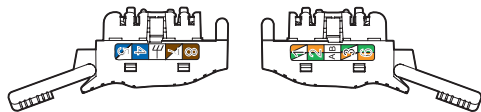

- Ouverture du connecteur
- De connector openen
- Opening the connector
- Öffnen des Steckers

- Apertura del conector
- Abertura do conector
- Otworzenie złącza
- Открытие разъема

- 打开连接头
- فتح الفوصل

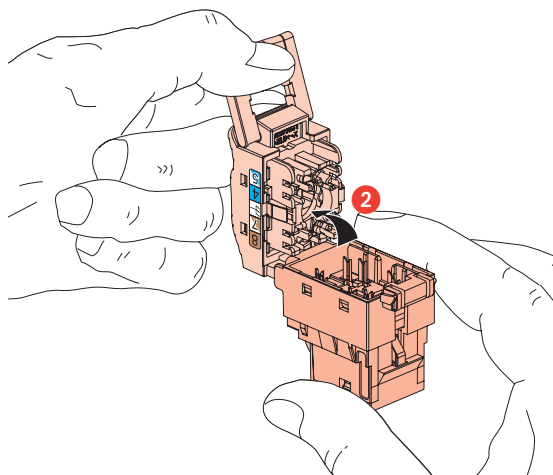
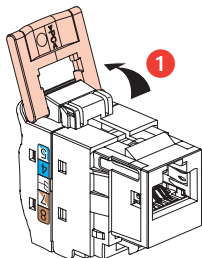

OK ✓

NO ✗

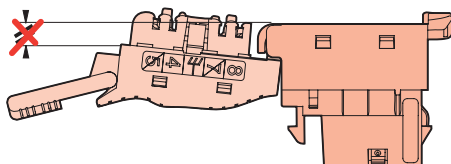
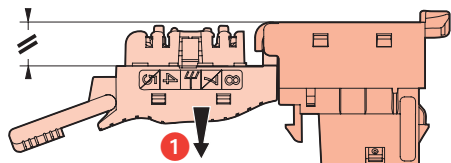

- Préparation connecteur UTP
- De connector UTP voorbereiden
- Preparing the UTP connector
- Vorbereitung UTP-Stecker

- Preparación conector UTP
- Preparação de conector UTP
- Przygotowanie złącza UTP
- Подготовка разъема UTP

- 准备UTP接头
- إعداد الموصل UTP

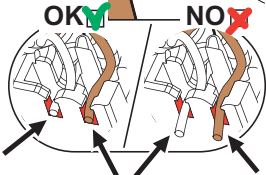
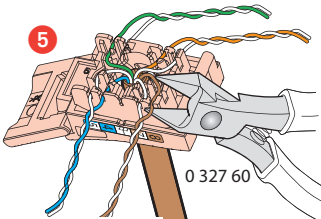
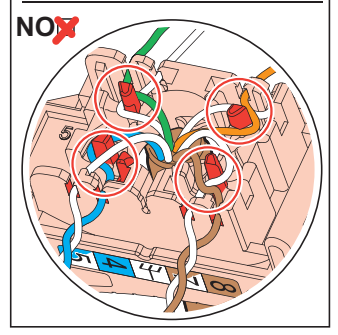
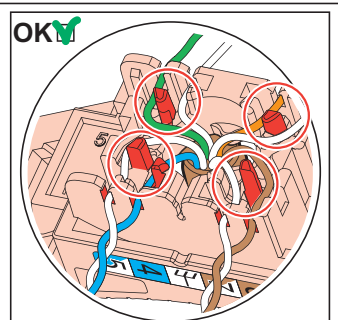
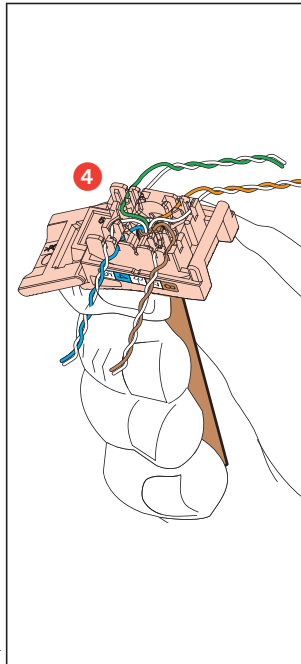
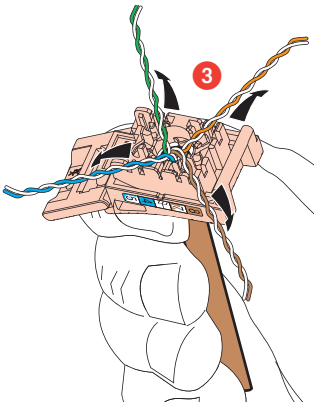
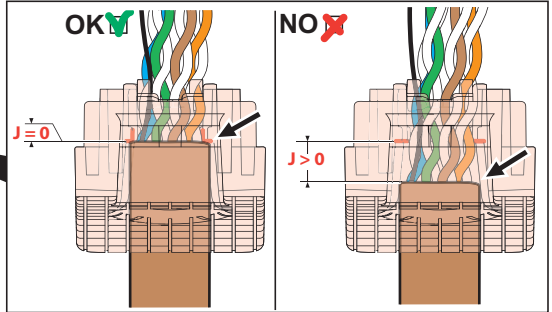
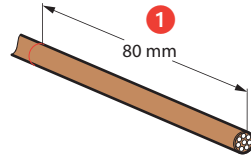
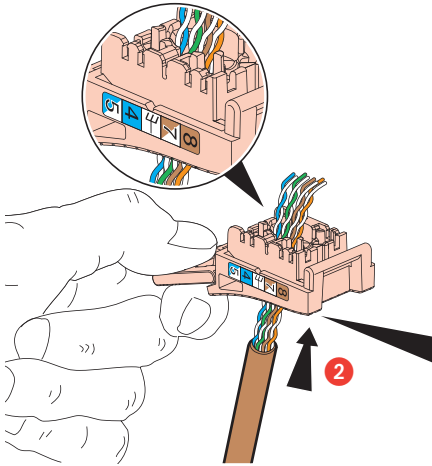

- Fermeture connecteur UTP
- De connector UTP sluiten
- Closing the UTP connector
- Schließen UTP-Stecker

- Cierre conector UTP
- Fecho de conector UTP
- Zamknięcie złącza UTP
- Закрытие разъема UTP

- 关闭UTP连接头
- غلق الموصل UTP

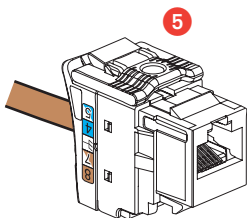
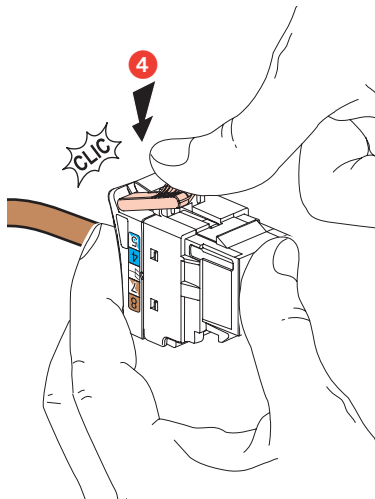
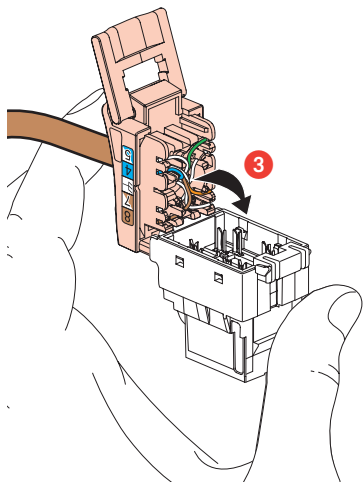
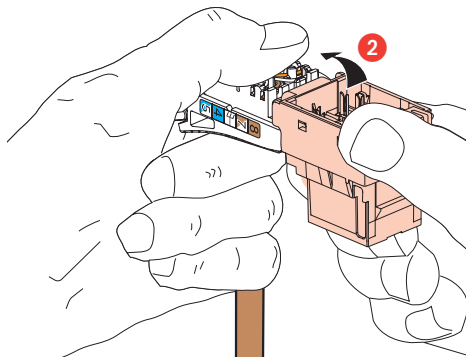
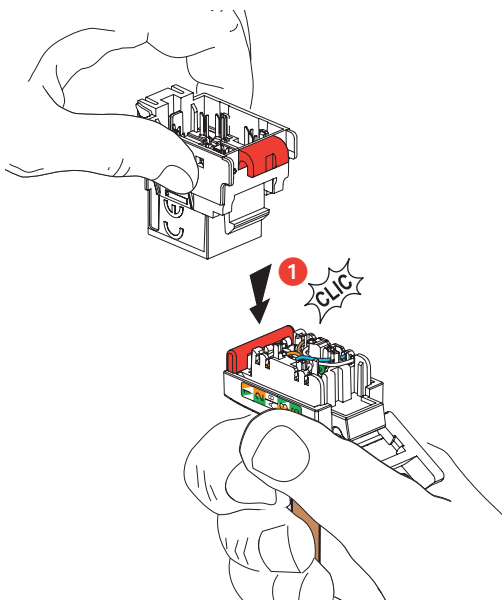

- Préparation connecteur FTP
- De connector FTP voorbereiden
- Preparing the FTP connector
- Vorbereitung FTP-Stecker

- Preparación conector FTP
- Preparação de conector FTP
- Przygotowanie złącza FTP
- Подготовка разъема FTP

- 准备FTP连接头
- إعداد الموصل FTP

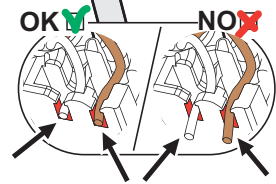
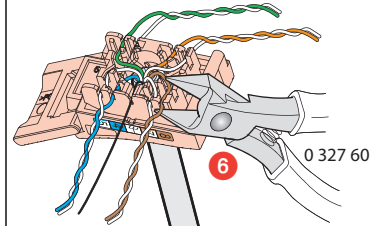
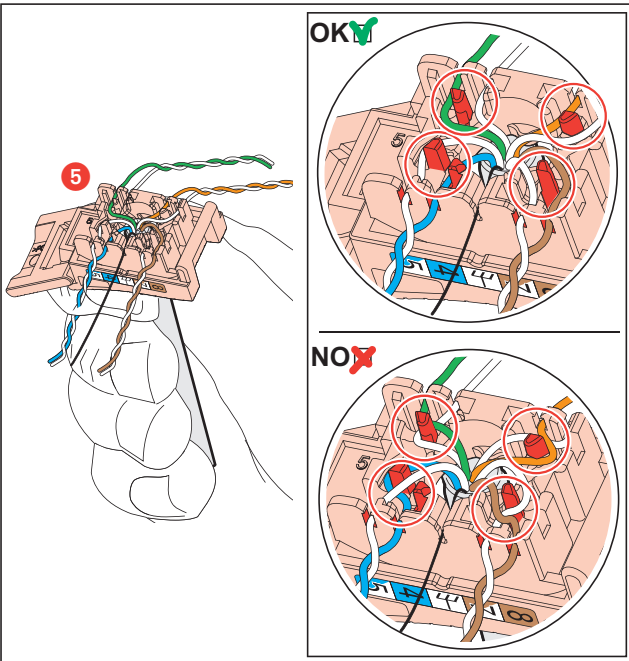
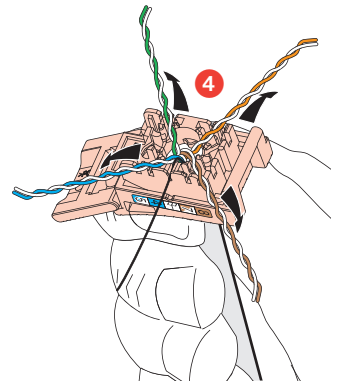
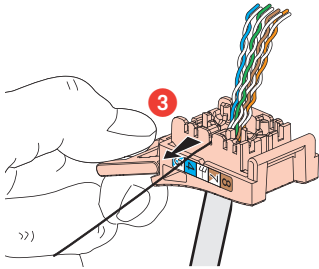
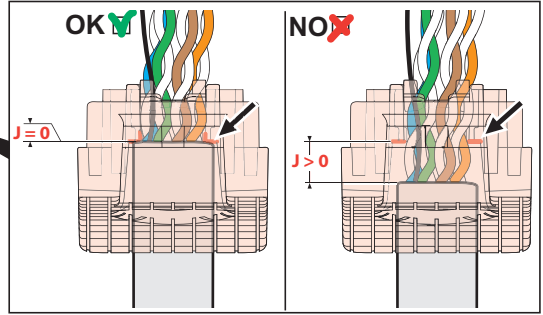
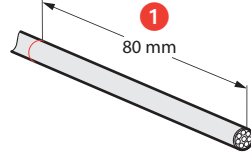
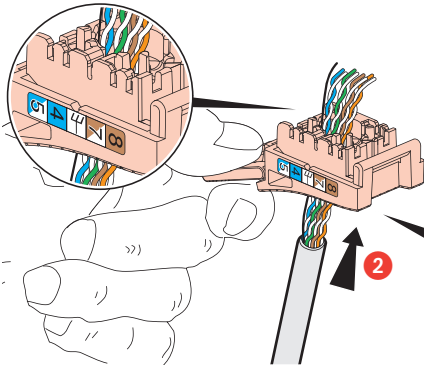

- Fermeture connecteur FTP
- De connector FTP sluiten
- Closing the FTP connector
- Schließen FTP-Stecker

- Cierre conector FTP
- Fecho de conector FTP
- Zamknięcie złącza FTP
- Закрыццё раз'ёма FTP

- 关闭FTP 连接头
- غلق الموصل FTP

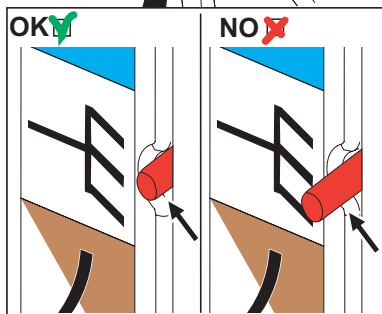
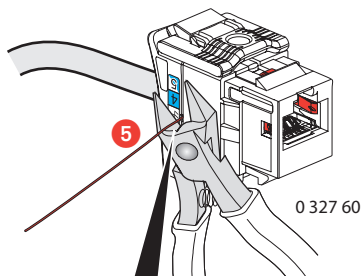
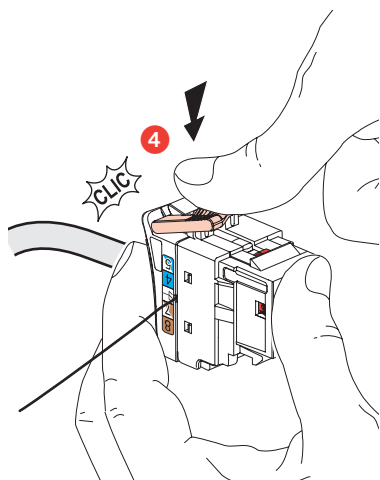
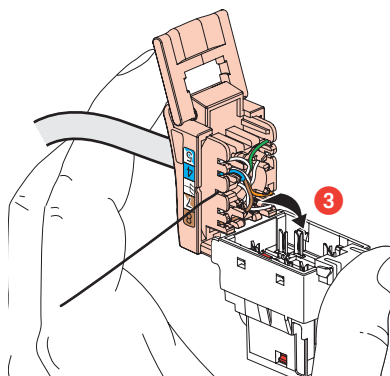
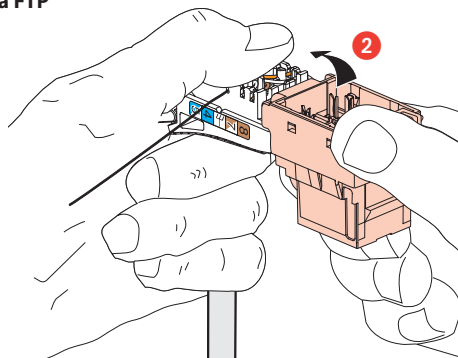
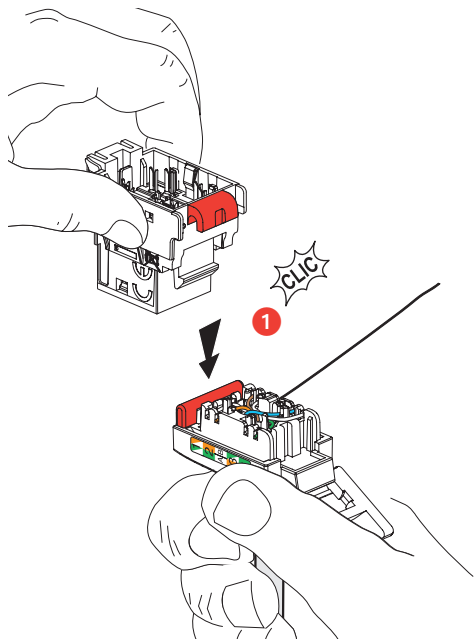

- Préparation connecteur STP
- De connector STP voorbereiden
- Preparing the STP connector
- Vorbereitung STP-Stecker

- Preparación conector STP
- Preparação de conector STP
- Przygotowanie złącza STP
- Подготовка разъема STP

- 准备STP接头
- إعداد الموصل STP

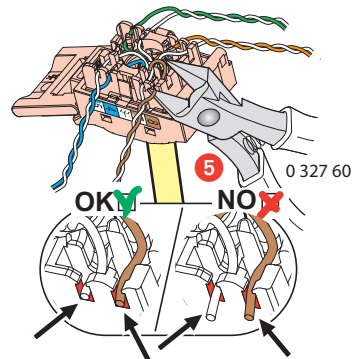
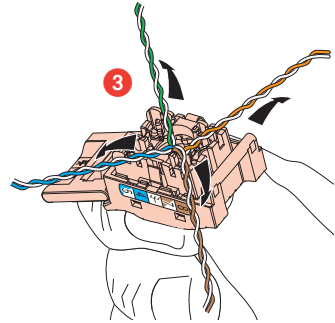
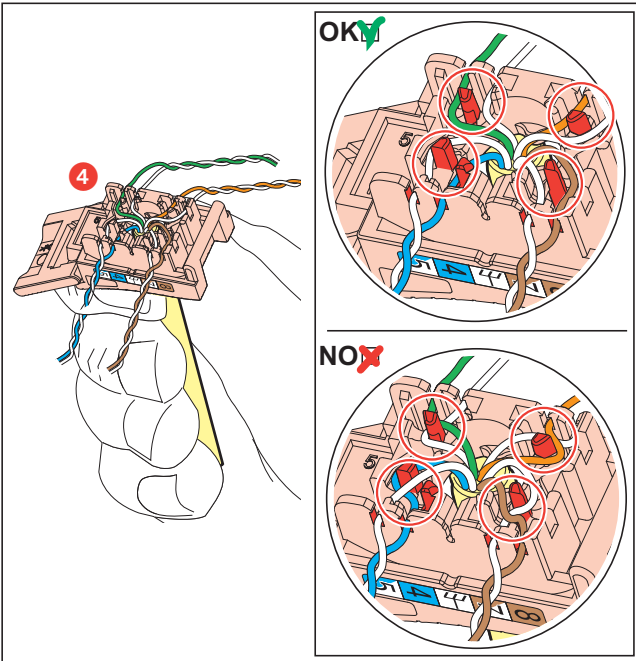
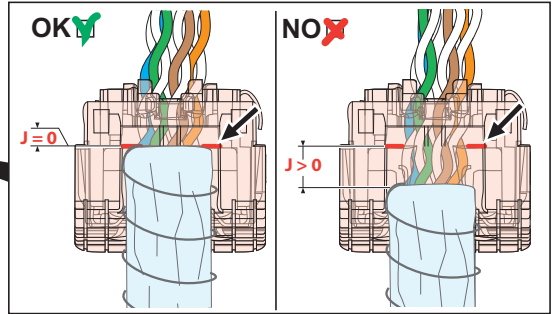
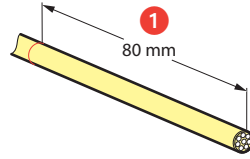
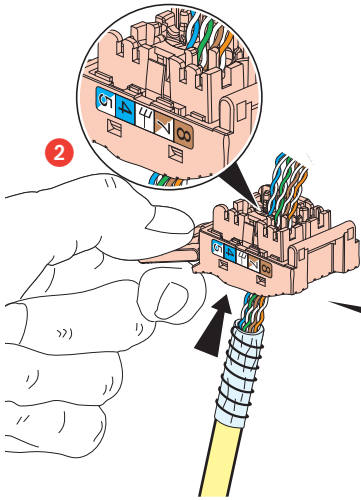

- Fermeture connecteur STP
- De connector STP sluiten
- Closing the STP connector
- Schließen STP-Stecker

- Cierre conector STP
- Fecho de conector STP
- Zamknięcie złącza STP
- Закрыццё раз'ёма STP

- 关闭STP连接头
- غلق الموصل STP

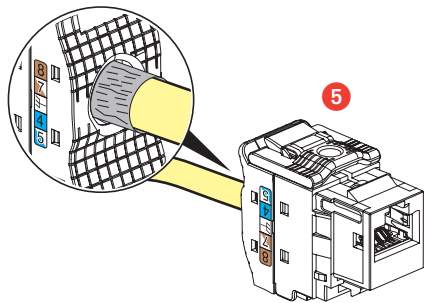
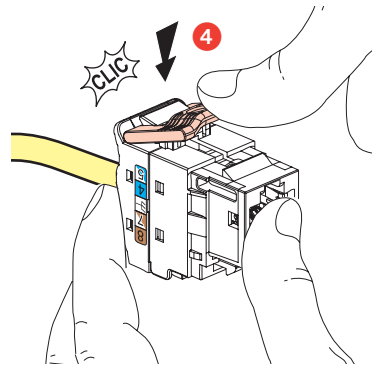
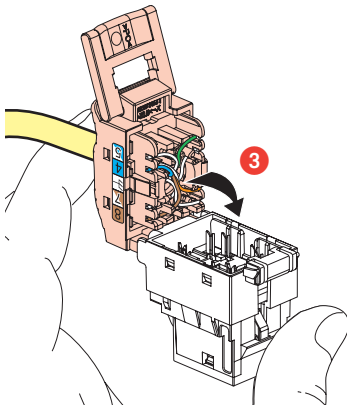
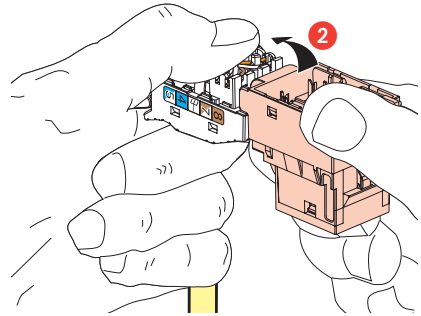
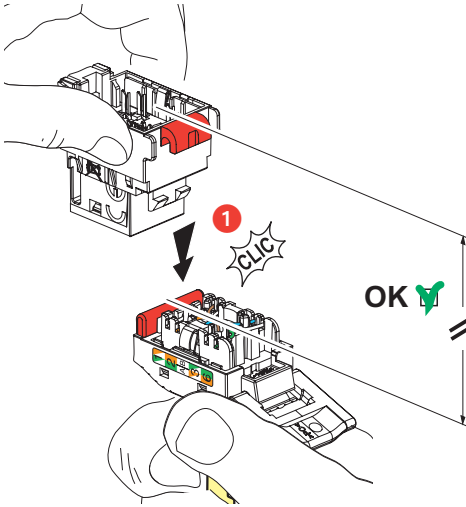

Consignes de sécurité

Avant toute intervention, couper le courant.
Respecter strictement les conditions d'installation et d'utilisation.

(FR) (LI) (HE) (CH)

Veilighedsvoorschriften

Onderbreek voor enige ingreep de stroom.
Neem de installatie- en gebruiksvoorwaarden nauwgezet in acht.

(NL) (BE)

Safety instructions

Make sure the power supply is disconnected before any intervention.
Strictly comply with instructions for installation and use.

(GB) (IE)

Sicherheitshinweise

Vor jeglichem Eingriff die Spannungsfreiheit sicherstellen.
Einbau- und Gebrauchsanleitungen sind genau zu beachten.

(DE) (CH)

Consignas de seguridad

Antes de realizar cualquier intervención, cortar la corriente eléctrica.
Respetar estrictamente las condiciones de instalación y uso.

(ES)

Instruções de segurança

Antes de qualquer intervenção, desligar a corrente.
Respetar rigorosamente as condições de instalação e de utilização.

(PT)

Przepisy bezpieczeństwa

Przed każdą czynnością na urządzeniu, odłączyć dopływ prądu.
Ścisłe przestrzegać instrukcji dotyczących instalacji i użytkowania.

(PL)

Меры предосторожности

Отключить питание перед проведением любых ремонтных работ.
Строго соблюдайте требования к условиям монтажа и эксплуатации.

(RU)

安全提示

在任何干涉以前一定要断电，严格遵守安全和使用的规定。

إرشادات الأمان:
القطع التيار الكهربائي قبل أي تدخل. تلبيةً لعمليّة تماماً بشروط التركيب والاستخدام.