

6 - Control, timing & monitoring relays



Control relays.....6.1 - 6.38

Features and benefits	6.1
General information	
Panorama	6.2 - 6.3
Technical terms and definitions.....	6.4
IEC Standards, utilization categories	6.5
Pilot duty ratings and overload trip classes.....	6.6
NF/NFZ control relays	6.7
Selection	
NF, 4 & 8 pole	6.8
NFZ, 4 & 8 pole.....	6.9
NS/NSL 4 & 8 pole	6.10
NS/NSL 4 & 8 pole, spring terminated	6.11
K6 miniature, 4 pole	6.12
KC6 miniature, 4 pole	6.13
KC6 interface relays, 4 pole	6.14
Accessory fitting details	
NF(Z), 4 & 8 pole.....	6.15
NS/L 4 & 8 pole, screw terminated.....	6.16
NS/L 4 & 8 pole, spring terminated	6.17
Accessories	
Auxiliary contact blocks & interlocks.....	6.18
Surge suppression for control relay coils	6.19
Electronic timers	6.20
Function markers, protective covers & coil terminal blocks.....	6.21
Terminal marking & positioning.....	6.22 - 6.25
Technical data	6.26 - 6.37

Timers & monitors6.39 - 6.298

General information	
Overview.....	6.40
Approvals and marks	6.41
CT-D Range timers	
Benefits and advantages.....	6.44
Ordering details.....	6.45
Function diagrams	6.46 - 6.48
Connection diagrams.....	6.49
Technical data & diagrams	6.50 - 6.52
Approximate dimensions.....	6.53
CT-E Range timers	
Benefits and advantages.....	6.56
Ordering details.....	6.57 - 6.58
Function diagrams	6.59 - 6.63
Connection diagrams.....	6.64
Technical data & diagrams	6.65 - 6.67
Approximate dimensions.....	6.68
CT-S Range timers	
Benefits and advantages.....	6.70
Conversion table.....	6.71
Ordering details.....	6.72 - 6.74
Accessories	6.75 - 6.76
Function diagrams	6.77 - 7.84
Connection diagrams.....	6.85 - 6.87
Technical data & diagrams	6.88 - 6.91
Wiring notes.....	6.92
CM-E Range	
Benefits and advantages.....	6.94 - 6.95
Monitoring features and application ranges	6.96 - 6.98
Current & voltage monitoring relays	
Benefits and advantages.....	6.100
Selection and conversion	6.101 - 6.102

Ordering details.....	6.103 - 6.104
Function diagrams	6.105 - 6.106
Connection diagrams	6.109
Technical data.....	6.110 - 6.113

Three-phase monitoring relays

Benefits, advantages & applications	6.116
Selection and conversion	6.117 - 6.118
Ordering details.....	6.119 - 6.120
Function diagrams	6.121 - 6.125
Connection diagrams, DIP switches	6.126 - 6.127
Technical data.....	6.128 - 6.137

Insulation monitoring relays

Benefits and advantages.....	6.140
Insulation monitoring in IT systems.....	6.141
Application/monitoring function, measuring principles	6.142
Characteristics	6.143
Selection and conversion table.....	6.144
Ordering details.....	6.145
Operating state indication	6.146
Connection diagrams, DIP switches.....	6.147
Technical data	6.148 - 6.151
Application examples	6.152

Motor load monitoring relays

Fields of application	7.154
Ordering details.....	6.155
Technical data.....	6.157

Motor control and protection

Benefits and advantages.....	6.160
Technical data.....	6.161 - 6.162

Thermistor motor protection

Benefits and advantages.....	6.164
Product overview	6.165 - 6.166
Ordering details.....	6.167 - 6.168
Technical information.....	6.169 - 6.171

Temperature monitoring relays

Benefits and advantages.....	6.174
Selection and conversion	6.175
Ordering details.....	6.176
Overview, functional description and diagrams.....	6.177 - 6.178
Connection diagrams, resistance thermometer sensors	6.179
Technical data.....	6.180 - 6.182

Liquid level monitors & controls

Benefits and advantages.....	6.164
Ordering details.....	6.185 - 6.186
Function diagrams	6.187 - 6.188
Connection diagrams	6.189
Application examples	6.190 - 6.191
Technical data.....	6.192 - 6.194

Contact protection & sensor interface relays

Ordering details.....	6.196
Technical information.....	6.197 - 6.199

Cycle monitoring relay with watchdog function

Ordering details.....	6.202
Technical data.....	6.203

General technical data

Load limit curves	6.204
Approximate dimensions.....	6.205
Accessories	6.206 - 6.207

Continued next page

CR Range

Interface relays

Benefits and advantages.....	6.212
Approvals and marks	6.213
Ordering details.....	6.214 - 6.220
Technical data.....	6.221 - 6.223
Load limit curves.....	6.224
Connection diagrams.....	6.225
Approximate dimensions.....	6.226 - 6.227

Interface relays, R600, R500

Benefits and advantages.....	6.230
Type designators.....	6.231
Selection.....	6.232 - 6.233

Interface relays, R600

Benefits and advantages.....	6.234
Ordering details.....	6.235 - 6.236
Connection diagrams.....	6.237
Technical information.....	6.238 - 6.242

Interface relays, R500

Selection.....	6.243
Ordering details.....	6.244
Technical information.....	6.245

Optocouplers

Optocouplers, R600

Selection.....	6.248 - 6.249
Ordering details.....	6.250
Connection diagrams.....	6.251
Technical data.....	6.252 - 2.555

Optocouplers, R500

Selection.....	6.256 - 6.257
Connection diagrams.....	6.258
Technical data.....	6.259 - 6.264

Accessories..... 6.266 - 6.273

CL Range

Logic relays

System overview.....	6.276 - 6.277
Approvals and marks	6.278
Ordering details.....	6.279 - 6.282
Technical data.....	6.283 - 6.296
Approximate dimensions.....	6.297 - 6.298

Control relays



Industrial control relays

Pilot duty rated for control circuits

Positively guided, AC & DC controlled



NF / NFZ control relays

- 4 & 8 pole control relays
- Pilot duty rated up to 10 A
- For AC & DC control circuit switching
- Electronic AC/DC coil input voltages
- NFZ with low power consumption coils
- Direct PLC control $\geq 24\text{VDC}$, 500mA (NFZ)
- Mechanically linked contacts for safety
- Wide variety of accessories

NS / NSL control relays

- 4 & 8 pole control relays
- For high-volume applications
- Pilot duty rated up to 10 A
- Bulk packaging available
- Screw & spring termination
- Mechanically linked contacts for safety
- AC or DC coil input voltages

K / KC control & interface relays

- 4 pole miniature control relays
- Compact solutions up to 10 A
- Quick-connect & PCB mount options
- Interface relays for PLC control
- Mechanically linked contacts for safety
- AC or DC coil input voltages

Standards & approvals	NF / NFZ	NS / NSL	K / KC
	E252354	E252354	E48139
			LR56745
	✓	✓	✓
	✓	✓	✓

NOTE: K/C6 quick-connect and PCB-mount versions are UL recognized.

General information



Panorama



Control relays

Mini control relays – 4 pole





6

IEC	AC-15 Rated operational current	400 V	A
UL/CSA	Pilot duty		
			Type
			Type
			Type

3		
A 600		
		
K6-22Z	K6-31Z	K6-40E
KC6-22Z	KC6-31Z	KC6-0E
—	—	—

See pages 6.12...6.14

IEC	AC-15 Rated operational current	400 V	A
UL/CSA	Pilot duty		
			Type
			Type
			Type

—	—	—
—	—	—
—	—	—

General information

Panorama

Control relays – 4 pole



3 A 600, Q 300			3 A 600, Q 600		
NS22E NS22ES	NS31E NS31ES	NS40E NS40ES	NF22E NFZ22E	NF31E NFZ31E	NF40E NFZ40E
NSL22E NSL22ES	NSL31E NSL31ES	NSL40E NSL40ES	NF22E NFZ22E	NF31E NFZ31E	NF40E NFZ40E
–	–	–	NF22E NFZ22E	NF31E NFZ31E	NF40E NFZ40E
See pages 6.10...6.11			See pages 6.8...6.9		

6

Control relays – 8 pole



3 A 600, Q 300					3 A 600, Q 600				
NS44E NS44ES	NS53E NS53ES	NS62E NS62ES	NS71E NS71ES	NS80E NS80ES	NF44E NFZ44E	NF53E NFZ53E	NF62E NFZ62E	NF71E NFZ71E	NF80E NFZ80E
NSL44E NSL44ES	NSL53E NSL53ES	NSL62E NSL62ES	NSL71E NSL71ES	NSL80E NSL80ES	NF44E NFZ44E	NF53E NFZ53E	NF62E NFZ62E	NF71E NFZ71E	NF80E NFZ80E
–	–	–	–	–	NF44E NFZ44E	NF53E NFZ53E	NF62E NFZ62E	NF71E NFZ71E	NF80E NFZ80E
See pages 6.10...6.11					See pages 6.8...6.9				

General information

Technical terms and definitions

Altitude

Refers to the height of the site where the equipment is located, expressed in meters above the sea level.

Ambient temperature

Temperature of the air surrounding the unit.

Circuits

• Auxiliary circuit

All the conducting parts of a contactor, intended to be included in a circuit different from the main circuit and the control circuit of the contactor e.g. signalization, interlocking circuits etc ...

• Control circuit

All the conducting parts of a contactor (other than the main circuit) included in a circuit used for the closing operation, or opening operation, or both, of the contactor.

• Main circuit

All the conducting parts of a contactor included in the circuit which it is designed to close or open.

Coil operating range

Expressed as a multiple of the rated control circuit voltage U_c for the lower and upper limits.

Cycle duration

Total time of the on-load + off-load period.

Endurance / durability

• Electrical endurance

Number of on-load operating cycles (i.e. with current on the main contacts) a contactor can achieve, varies depending on the utilization category.

• Mechanical endurance

Number of off-load operating cycles (i.e. without current on the main contacts) a contactor can achieve.

Inching

Energizing a motor once or repeatedly for short periods to obtain small movements of the driven mechanism.

Insulation class according to the VDE 0110 and NFC 20-040

Characterizes contactors suitability in accordance with environment and utilization conditions. A contactor can be classified depending on its own clearance and creepage distances in the insulation classes A, B, C, D which correspond to different insulation voltage values.

The insulation class C is applicable to most of the industrial applications. Equipment described in this catalogue correspond to insulation class C.

Intermittent duty

Duty in which the main contacts of a contactor remain closed for periods of time insufficient to allow the contactor to reach thermal equilibrium, the current-carrying periods being separated by off-load periods of sufficient duration to restore equality of temperature with the cooling medium.

Mounting positions

Stated by the manufacturer. Please note restrictions when applicable.

On-load factor

Ratio of the current flow time to the total time of the cycle x 100.

Plugging

Stopping or reversing a motor quickly by interchanging two supply leads whilst the motor is running.

Rated breaking capacity; Rated making capacity

Value of r.m.s current a contactor can break or make at a fixed voltage value, within the conditions specified by the standards, depending on the utilization category.

Rated control circuit voltage U_c

Control voltage value for which the control circuit of the unit is sized.

Rated insulation voltage U_i

Voltage value which designates the unit and to which dielectric tests, clearance and creepage distances are referred.

Rated impulse withstand voltage U_{imp}

The highest peak value of an impulse voltage of prescribed form 1.2/50, which does not cause breakdown under specified conditions of test.

Rated operating current I_e

Current value stated by the manufacturer and taking into account the rated operating voltage U_e , the rated frequency, the rated duty, the utilization category, the electrical contact life and the type of the protective enclosure.

Rated operating voltage U_e

Voltage value to which utilization characteristics of the contactor are referred, i.e. phase to phase voltage in 3 phase circuits.

Conventional thermal current I_{th}

Value of current the contactor can withstand with poles in closed position, in free air for an eight hour duty, without the temperature rise of its various parts exceeding the limits specified by the standards.

Resistance to shocks

Requirements applicable for instance to vehicles, crane operation or switchgear slide-in module systems.

At the quoted permissible «g» values, contactors must not undergo a change in switching state and O/L relays must not trip.

Resistance to vibrations

Requirements applicable to all the vehicles, vessels and other similar transport systems. At the quoted amplitude and vibration frequency values, the unit must be capable to achieve the required duty.

Short-circuit protection coordination

Achieved by using back-up protection devices such as circuit-breakers, H.R.C. fuses or standard fuses.

Co-ordination types a, b, c are defined in IEC 292-1 publication, VDE 0660, NFC 63-650 standards. Co-ordination types "1" and "2" are defined in IEC 947-4-1.

• Type 1 co-ordination

There has been no discharge of parts beyond the enclosure. Damage to the contactor and the overload relay is acceptable.

• Type 2 co-ordination

No damage to the overload relay or other parts has occurred, except that welding of contactor or starter contacts is permitted, if they are easily separated.

Switching frequency

Number of operating cycles per hour.

Time

• Closing time

Time between energization of the coil until the moment the contacts of the first current path to be closed actually close.

• Opening time

Time from the beginning of state causing breaking until the moment when the contacts of the last current path to be opened are open.

• Minimal operation time

Shortest control duration to ensure complete closing or opening of a contactor.

• Short time current permissible

Value of current which the contactor can withstand in closed position for a short time period and within specified conditions.

• Time constant

Ratio of inductance to the resistance : $L/R = \text{mH}/\text{Ohm} = \text{ms}$.

General information

IEC Standards, utilization categories

Standards

- IEC standards 158-1: "Contactors" and series IEC 292 :

"Motor-starters" have been revised and replaced by the new IEC 947-4-1 (1990-05): "Contactors and Motor-starters" referring to IEC 947-1 (1988): "General rules" The new standards will constitute the basis of the future European and National standards, not yet revised.

Therefore the ratings indicated in this catalog are established according to the former and the future standards.

- Main changes and additions in the new standards are:
- Revision and extension of the utilization categories (see hereafter)
- Replacement of the coordination classes types a, b, c by new types: "1" (approximately equivalent to former class "a") and "2" (approximately equivalent to former class "c") with additional requirements.
- Classification of the thermal overload relays in tripping classes: 10 A; 10; 20 and 30 depending on their tripping times, at 1.5 and 7.2 times their setting current, in order to cover motor applications depending on their starting times. Class 10 A is adapted for motors according to IEC 34-1.
- Introduction of tests to verify the connecting capability and the mechanical strength of terminals.

Utilization categories

A contactor duty is characterized by the utilization category plus indication of the rated operating voltage and the rated operating current (see at Rated ...), or the motor characteristics.

Utilization categories for contactors according to IEC 947-4-1

Alternating current:	AC-1	Non-inductive or slightly inductive loads, resistance furnaces. Power factor 0.7 - 0.8 (slightly inductive).
	AC-2	Slip-ring motors: starting, switching-off.
	AC-3	Squirrel-cage motors: starting, switching-off motors during running. Power factor 0.4 - 0.5 (AC-3).
	AC-4	Squirrel-cage motors: starting, plugging, inching.
	AC-5a	Switching of electric discharge lamp controls.
	AC-5b	Switching of incandescent lamps.
	AC-6a	Switching of transformers.
	AC-6b	Switching of capacitor banks
	AC-8a AC-8b	Hermetic refrigerant compressor motor control with manual resetting of overload releases Hermetic refrigerant compressor motor control with automatic resetting of overload releases.
Direct current:	DC-1	Non-inductive or slightly inductive loads, resistance furnaces.
	DC-3	Shunt motors: starting, plugging, inching. Dynamic breaking of d.c. motors.
	DC-5	Series motors: starting, plugging, inching. Dynamic breaking of d.c. motors.
	DC-6	Switching of incandescent lamps

Utilization categories for contactor relays according to IEC 947-5-1

Alternating current:	AC-12	Control of resistive loads and solid state loads with isolation by opto couplers.
	AC-13	Control of solid state loads with transformer isolation.
	AC-14	Control of small electromagnetic loads (≤ 72 VA).
	AC-15	Control of electromagnetic loads (> 72 VA).
Direct current:	DC-12	Control of resistive loads and solid state loads with isolation by opto couplers.
	DC-13	Control of electromagnets.
	DC-14	Control of electromagnetic loads having economy resistors in circuit.

Utilization categories AC-1, AC-2, AC-3, AC-4 and DC-1, DC-3, DC-5 are maintained with slightly more severe tests.

Other categories have been added in order to standardize specific applications. In fact some contactor applications and the specific criteria characterizing the types of load controlled can modify the recommended utilization characteristics. These major applications are, for example :

Switching of capacitor banks

This application is characterized by high current peaks when switching-on the contactor and presence of harmonic currents on uninterrupted duty. For this application, IEC 947-4-1 has defined an utilization category AC-6b. Practical ratings have to be defined according to tests or, in absence of tests, by a calculation indicated in IEC 947-4-1.

Switching of transformers

This application is characterized by high current peaks on contactor closing due to magnetization phenomena. The corresponding utilization category according to IEC 947-4-1 is AC-6a. Ratings are derived from test-values for AC-3 or AC-4 according to formula given in IEC 947-4-1.

Switching of lighting circuits

The current peaks on contactor closing and power factor vary depending on the type of lamps, the switching method used and if compensation systems are fitted or not.

IEC 947-4-1 contains two standard utilization categories

- AC-5a for switching of the electric discharge lamps.
- AC-5b for switching of incandescent lamp.

General information

Pilot duty ratings and overload trip classes

Pilot duty ratings for AC control circuit contacts

Contact rating designation	Continuous thermal, test current (A)	Maximum current, 50/60 Hz (A)									
		120 v ac		240 v ac		480 v ac		600 v ac		Volt-amperes	
		Make	Break	Make	Break	Make	Break	Make	Break	Make	Break
A150	10	60	6.00	-	-	-	-	-	-	7200	720
A300	10	60	6.00	30	3.00	-	-	-	-	7200	720
A600	10	60	6.00	30	3.00	15	1.50	12	1.20	7200	720
B150	5	30	3.00	-	-	-	-	-	-	3600	360
B300	5	30	3.00	15	1.50	-	-	-	-	3600	360
B600	5	30	3.00	15	1.50	7.5	0.75	6	0.60	3600	360
C150	2.5	15	1.5	-	-	-	-	-	-	1800	180
C300	2.5	15	1.5	7.5	0.75	-	-	-	-	1800	180
C600	2.5	15	1.5	7.5	0.75	3.75	0.375	3.00	0.30	1800	180
D150	1.0	3.60	0.60	-	-	-	-	-	-	432	72
D300	1.0	3.60	0.60	1.80	0.30	-	-	-	-	432	72
E150	0.5	1.80	0.30	-	-	-	-	-	-	216	36

Mechanical switching ratings and test values as published in Table 1-4-1 of NEMA ICS 5-2000 (R2005, R2010)

Pilot duty ratings for DC control circuit contacts

Contact rating designation	Continuous thermal, test current (A)	Maximum current, 50/60 Hz (A)							
		120 v dc		250 v dc		301 to 600 v dc		Volt-amperes	
		Make / Break		Make / Break		Make / Break		Make / Break	
N150	10	2.2		-		-		275	
N300	10	2.2		1.1		-		275	
N600	10	2.2		1.1		0.40		275	
P150	5.0	1.1		-		-		138	
P300	5.0	1.1		0.55		-		138	
P600	5.0	1.1		0.55		0.20		138	
Q150	2.5	0.55		-		-		69	
Q300	2.5	0.55		0.27		-		69	
Q600	2.5	0.55		0.27		0.10		69	
R150	1.0	0.22		-		-		28	
R300	1.0	0.22		0.11		-		28	

Mechanical switching ratings and test values as published in Table 1-4-1 of NEMA ICS 5-2000 (R2005, R2010)

Pilot duty rating explanation

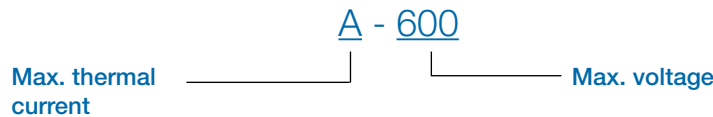

General information

NF/NFZ control relays

4 & 8 pole

Description

NF / NFZ control relays are provided in either four or eight auxiliary pole configurations with a variety of accessories including additional auxiliary contacts and electronic timers.

Application

NF / NFZ control relays are pilot duty rated and primarily used for switching both AC and DC control circuits.

Control circuit types

NF / NFZ coils are designed to utilize both AC (50/60 Hz) and DC control circuit inputs ranging from 12...500V. Surge suppression is included. NFZ types offer low power consumption coils.

Control relay types

4-pole:

NF(Z)22E, NF(Z)31E, NF(Z)40E

8-pole:

NF(Z)44E, NF(Z)53E, NF(Z)62E
NF(Z)71E, NF(Z)80E

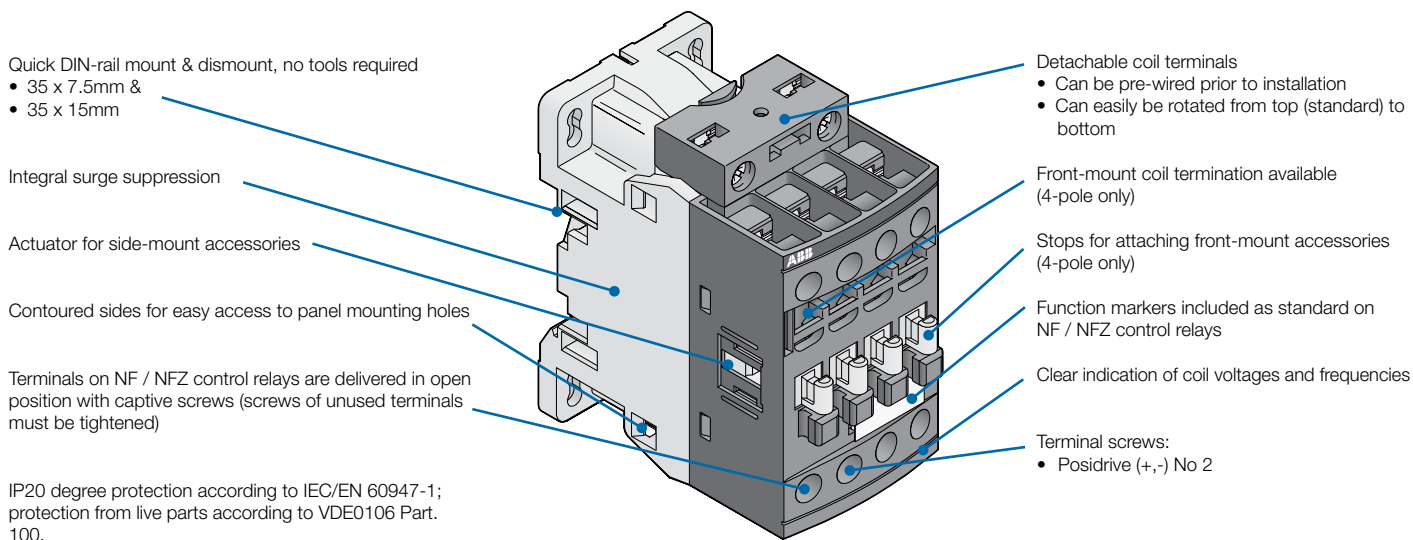

Catalog number explanation

For reference only – not all combinations will produce valid catalog numbers

NF 31 E - 13

Control relay type

Control relay type

- 22 = 2 NO / 2 NC
- 31 = 3 NO / 1 NC
- 40 = 4 NO
- 44 = 4 NO / 4 NC
- 53 = 5 NO / 3 NC
- 62 = 6 NO / 2 NC
- 71 = 7 NO / 1 NC
- 80 = 8 NO

Coil voltage code

(see product selection pages)



NF, 4 & 8 pole

For pilot duty applications up to 10 A
Electronic AC/DC operated coils

Description

- **NF** control relays include an electronic coil interface accepting a wide control voltage U_c min. ... U_c max.
Only four coils cover control voltages between 24...500 V 50/60 Hz or 20...500 V DC
- **NF** control relays can manage large control voltage variations. One coil (i.e. 100...250 V 50/60 Hz - DC) can be used for different control voltages used worldwide without any coil change
- **NF** control relays have built-in surge protection and do not require additional surge suppressors
- The control relays have mechanically-linked auxiliary contacts compliant with Annex L of IEC 60947-5-1 and include the "Mechanically Linked" symbol on their side
- 8-pole control relays are mounted with a non-removable auxiliary contact block (2nd stack).

Ordering Details

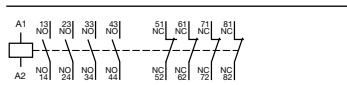
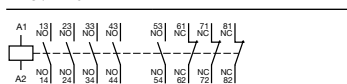
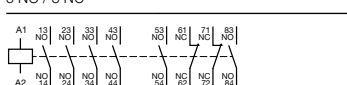
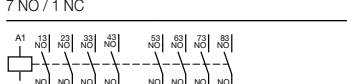
Number of contacts	Control voltage		Catalog number
	1 st stack	2 nd stack	
	Range		
	U_c min. ... U_c max.		
	V 50/60 Hz	V DC	
 2 NO / 2 NC	24...60	20...60	NF22E-11
	48...130	48...130	NF22E-12
	100...250	100...250	NF22E-13
	250...500	250...500	NF22E-14
 3 NO / 1 NC	24...60	20...60	NF31E-11
	48...130	48...130	NF31E-12
	100...250	100...250	NF31E-13
	250...500	250...500	NF31E-14
 4 NO	24...60	20...60	NF40E-11
	48...130	48...130	NF40E-12
	100...250	100...250	NF40E-13
	250...500	250...500	NF40E-14
 4 NO / 4 NC	24...60	20...60	NF44E-11
	48...130	48...130	NF44E-12
	100...250	100...250	NF44E-13
	250...500	250...500	NF44E-14
 5 NO / 3 NC	24...60	20...60	NF53E-11
	48...130	48...130	NF53E-12
	100...250	100...250	NF53E-13
	250...500	250...500	NF53E-14
 6 NO / 2 NC	24...60	20...60	NF62E-11
	48...130	48...130	NF62E-12
	100...250	100...250	NF62E-13
	250...500	250...500	NF62E-14
 7 NO / 1 NC	24...60	20...60	NF71E-11
	48...130	48...130	NF71E-12
	100...250	100...250	NF71E-13
	250...500	250...500	NF71E-14
 8 NO	24...60	20...60	NF80E-11
	48...130	48...130	NF80E-12
	100...250	100...250	NF80E-13
	250...500	250...500	NF80E-14

Main dimensions mm, inches

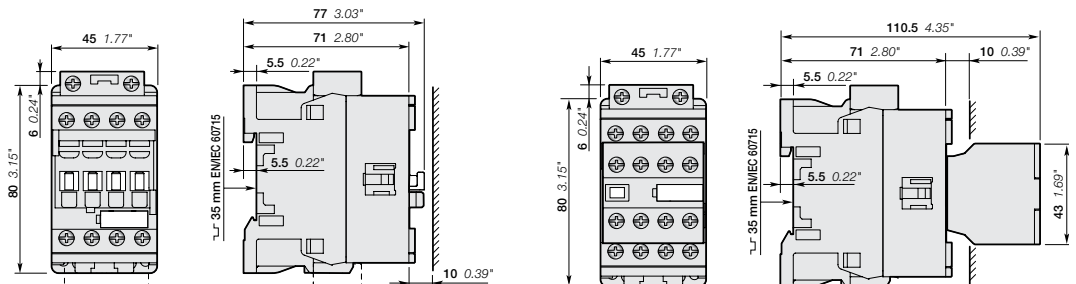

NF...22E, NF...31E, NF...40E

NF...44E, NF...53E, NF...62E, NF...71E, NF...80E

NFZ, 4 & 8 pole

For pilot duty applications up to 10 A

Low power consumption, electronic AC/DC operated coils

Description

– NFZ control relays include an electronic coil interface accepting a wide control voltage U_c min. ... U_c max. and managing large control voltage variations.

NFZ control relays cover control voltages between 24...250 V 50/60 Hz or 12...250 V DC

– NFZ control relays allow direct control by PLC-output ≥ 24 V DC 500 mA and obtain a reduced holding coil consumption.

NFZ control relays withstand short dips and voltage interruptions (SEMI F47-0706 compliance)

– NFZ control relays have built-in surge protection and do not require additional surge suppressors

– The control relays have mechanically-linked auxiliary contacts compliant with Annex L of IEC 60947-5-1 and include the "Mechanically Linked" symbol on their side

– 8-pole control relays are mounted with a non-removable auxiliary contact block (2nd stack).



NFZ22E



NFZ44E

Ordering Details

Number of contacts 1 st stack 2 nd stack	Control voltage Range		Catalog number
	U_c min. ... U_c max.		
	V 50/60 Hz	V DC	
 2 NO / 2 NC	-	12...20	NFZ22E-20
	24...60	20...60	NFZ22E-21
	48...130	48...130	NFZ22E-22
	100...250	100...250	NFZ22E-23
 3 NO / 1 NC	-	12...20	NFZ31E-20
	24...60	20...60	NFZ31E-21
	48...130	48...130	NFZ31E-22
	100...250	100...250	NFZ31E-23
 4 NO	-	12...20	NFZ40E-20
	24...60	20...60	NFZ40E-21
	48...130	48...130	NFZ40E-22
	100...250	100...250	NFZ40E-23
 4 NO / 4 NC	-	12...20	NFZ44E-20
	24...60	20...60	NFZ44E-21
	48...130	48...130	NFZ44E-22
	100...250	100...250	NFZ44E-23
 5 NO / 3 NC	-	12...20	NFZ53E-20
	24...60	20...60	NFZ53E-21
	48...130	48...130	NFZ53E-22
	100...250	100...250	NFZ53E-23
 6 NO / 2 NC	-	12...20	NFZ62E-20
	24...60	20...60	NFZ62E-21
	48...130	48...130	NFZ62E-22
	100...250	100...250	NFZ62E-23
 7 NO / 1 NC	-	12...20	NFZ71E-20
	24...60	20...60	NFZ71E-21
	48...130	48...130	NFZ71E-22
	100...250	100...250	NFZ71E-23
 8 NO	-	12...20	NFZ80E-20
	24...60	20...60	NFZ80E-21
	48...130	48...130	NFZ80E-22
	100...250	100...250	NFZ80E-23

Main dimensions mm, inches

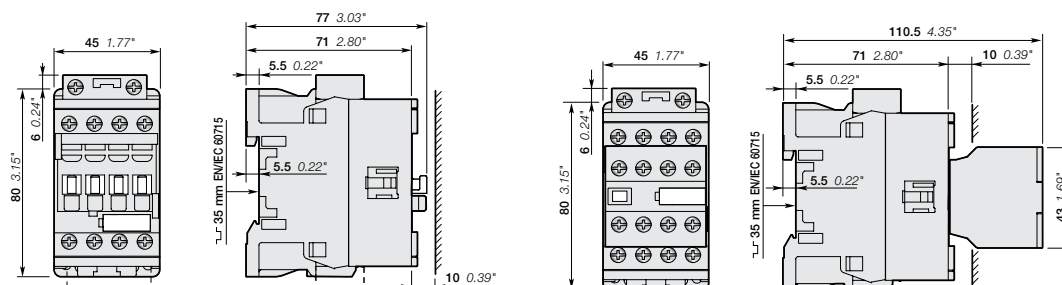

NS/NSL 4 & 8 pole

For pilot duty applications up to 10 A

AC or DC operated coils, bulk packaged for high volume

Description

NS/NSL contactor relays are used for switching auxiliary and control circuits.

These contactor relays are designed with:

- 4 poles or 8 poles. Contactor relays have mechanically linked auxiliary contact elements (side-marked symbol)
- Suitable for direct PLC control (DC 3W)
- add-on auxiliary contact blocks for front mounting and a comprehensive range of accessories.

Ordering details

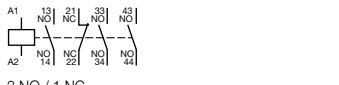
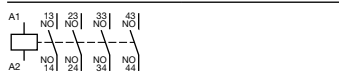
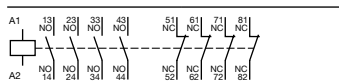
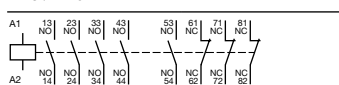
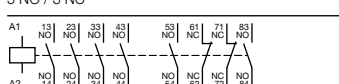
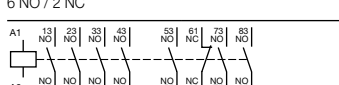
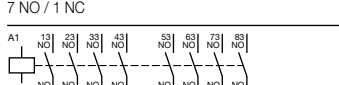
Number of contacts	Rated control circuit voltage U_c	Catalog number, AC controlled	Rated control circuit voltage U_c	Catalog number, DC controlled
 2 NO / 2 NC	V 50 Hz	24	24	NS22E-20M
	V 60 Hz	-	120	NS22E-16M
 3 NO / 1 NC	V 50 Hz	24	24	NS31E-20M
	V 60 Hz	-	120	NS31E-16M
 4 NO	V 50 Hz	24	24	NS40E-20M
	V 60 Hz	-	120	NS40E-16M
 4 NO / 4 NC	V 50 Hz	24	24	NS44E-20M
	V 60 Hz	-	120	NS44E-16M
 5 NO / 3 NC	V 50 Hz	24	24	NS53E-20M
	V 60 Hz	-	120	NS53E-16M
 6 NO / 2 NC	V 50 Hz	24	24	NS62E-20M
	V 60 Hz	-	120	NS62E-16M
 7 NO / 1 NC	V 50 Hz	24	24	NS71E-20M
	V 60 Hz	-	120	NS71E-16M
 8 NO	V 50 Hz	24	24	NS80E-20M
	V 60 Hz	-	120	NS80E-16M

NOTE: For DC operated devices, the polarity of A1+ and A2- must be respected.

Main dimensions mm, inches

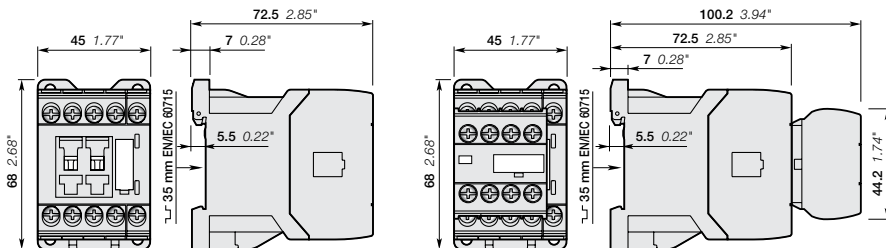

NS22E, NS31E, NS40E

NS44E, NS53E, NS62E, NS71E, NS80E



4 pole



8 pole

Standard bulk pack quantities (M)

Control relays	Quantity
NS/L22E NS/L31E NS/L40E	40
NS/L44E NS/L53E NS/L62E NS/L71E NS/L80E	20

Additional coil voltage codes

AC voltages		Coil code
V - 50 Hz	V - 60 Hz	
42	42	21
48	48	22
110	110	23
115	115	24
220	220	25
240	240	27
-	277	17
380	-	13
415	415	29

DC voltages		Coil code
V - DC		
12		80
60		84
125		87
240		89

NS/NSL 4 & 8 pole, spring terminated

For pilot duty applications up to 10 A
AC or DC operated coils, bulk packaged for high volume





Description

NS/NSL contactor relays are used for switching auxiliary and control circuits.

These contactor relays are designed with:

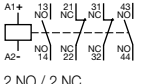
- 4 poles or 8 poles. Contactor relays have mechanically linked auxiliary contact elements (side-marked symbol)
- Suitable for direct PLC control (DC 3W)
- add-on auxiliary contact blocks for front mounting and a comprehensive range of accessories.

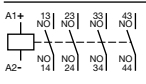
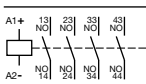
Ordering details

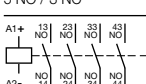
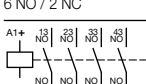
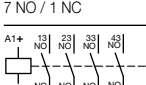
Number of contacts 1st stack 2nd stack	Rated control circuit voltage U_c		Catalog number, AC controlled	Rated control circuit voltage U_c	Catalog number, DC controlled
	V 50 Hz	V 60 Hz		V-DC	
 2 NO / 2 NC	24	24	NS22ES-20M	24	NSL22ES-81M
	-	120	NS22ES-16M	48	NSL22ES-83M
	230	230	NS22ES-26M	110	NSL22ES-86M
 3 NO / 1 NC	24	24	NS31ES-20M	24	NSL31ES-81M
	-	120	NS31ES-16M	48	NSL31ES-83M
	230	230	NS31ES-26M	110	NSL31ES-86M
 4 NO	24	24	NS40ES-20M	24	NSL40ES-81M
	-	120	NS40ES-16M	48	NSL40ES-83M
	230	230	NS40ES-26M	110	NSL40ES-86M
 4 NO / 4 NC	24	24	NS44ES-20M	24	NSL44ES-81M
	-	120	NS44ES-16M	48	NSL44ES-83M
	230	230	NS44ES-26M	110	NSL44ES-86M
 5 NO / 3 NC	24	24	NS53ES-20M	24	NSL53ES-81M
	-	120	NS53ES-16M	48	NSL53ES-83M
	230	230	NS53ES-26M	110	NSL53ES-86M
 6 NO / 2 NC	24	24	NS62ES-20M	24	NSL62ES-81M
	-	120	NS62ES-16M	48	NSL62ES-83M
	230	230	NS62ES-26M	110	NSL62ES-86M
 7 NO / 1 NC	24	24	NS71ES-20M	24	NSL71ES-81M
	-	120	NS71ES-16M	48	NSL71ES-83M
	230	230	NS71ES-26M	110	NSL71ES-86M
 8 NO	24	24	NS80ES-20M	24	NSL80ES-81M
	-	120	NS80ES-16M	48	NSL80ES-83M
	230	230	NS80ES-26M	110	NSL80ES-86M
		400	NS80ES-28M	220	NSL80ES-88M

NOTE: For DC operated devices, the polarity of A1+ and A2- must be respected.

Main dimensions mm, inches

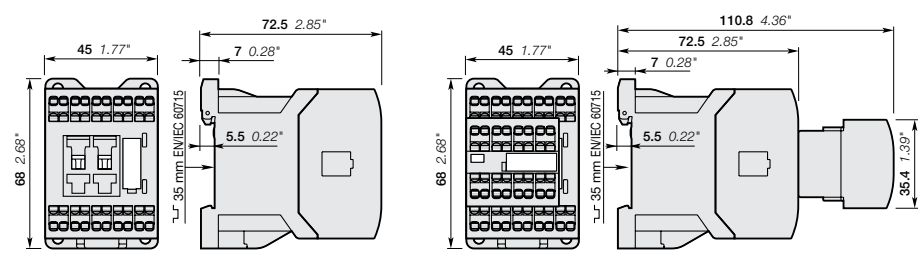

NSL22E, NSL31E, NSL40E

NSL44E, NSL53E, NSL62E, NSL71E, NSL80E



4 pole



8 pole

Standard bulk pack quantities (M)

Control relays	Quantity
NS/L22ES NS/L31ES NS/L40ES	40
NS/L44ES NS/L53ES NS/L62ES NS/L71ES NS/L80ES	20

Additional coil voltage codes

AC voltages		Coil code
V - 50 Hz	V - 60 Hz	
42	42	21
48	48	22
110	110	23
115	115	24
220	220	25
240	240	27
-	277	17
380	-	13
415	415	29

DC voltages		Coil code
V - DC		
12		80
60		84
125		87
240		89

K6 miniature, 4 pole

For compact pilot duty applications up to 10 A
AC operated coils

Description

These contactors are designed with:

- 4 poles with various contact combinations
- control circuit: AC operated, low coil consumption (3.5 VA at pull-in and at holding)
- hum-free coil
- add-on auxiliary contact blocks for front or side mounting
- designed for rail or wall mounting

Ordering details

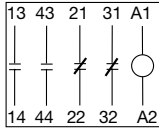
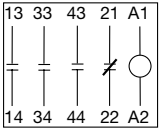
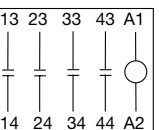
Number of contacts	Rated control circuit voltage U_c		Catalog number, screw termination	Catalog number, quick-connect termination	Catalog number, PCB-mount termination
	V-50 Hz	V-60 Hz			
 2 NO / 2 NC	24	24	K6-22Z-01	K6-22Z-F01	K6-22Z-P01
	42	42	K6-22Z-02	K6-22Z-F02	K6-22Z-P02
	48	48	K6-22Z-03	K6-22Z-F03	K6-22Z-P03
	110...127	110...127	K6-22Z-84	K6-22Z-F84	K6-22Z-P84
	220...240	220...240	K6-22Z-80	K6-22Z-F80	K6-22Z-P80
 3 NO / 1 NC	24	24	K6-31Z-01	K6-31Z-F01	K6-31Z-P01
	42	42	K6-31Z-02	K6-31Z-F02	K6-31Z-P02
	48	48	K6-31Z-03	K6-31Z-F03	K6-31Z-P03
	110...127	110...127	K6-31Z-84	K6-31Z-F84	K6-31Z-P84
	220...240	220...240	K6-31Z-80	K6-31Z-F80	K6-31Z-P80
 4 NO	24	24	K6-40E-01	K6-40E-F01	K6-40E-P01
	42	42	K6-40E-02	K6-40E-F02	K6-40E-P02
	48	48	K6-40E-03	K6-40E-F03	K6-40E-P03
	110...127	110...127	K6-40E-84	K6-40E-F84	K6-40E-P84
	220...240	220...240	K6-40E-80	K6-40E-F80	K6-40E-P80
380...415	380...415	K6-40E-85	K6-40E-F85	K6-40E-P85	



K6



K6...F



K6...P

Main dimensions mm, inches

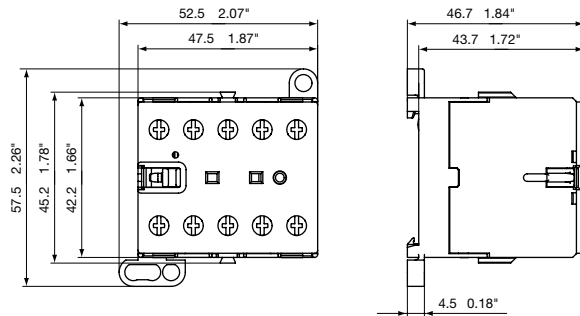

K6, K6...F

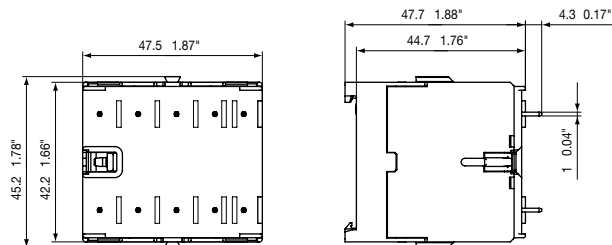

K6...P

KC6 miniature, 4 pole

For compact pilot duty applications up to 10 A
DC operated coils



KC6



KC6...F

Description

These contactors are designed with:

- 4 poles with various contact combinations
- control circuit: DC operated, low coil consumption (3.5 W at pull-in and at holding)
- hum-free coil
- add-on auxiliary contact blocks for front or side mounting
- designed for rail or wall mounting

Ordering details

Number of contacts	Rated control circuit voltage U_c	Catalog number, screw termination	Catalog number, quick-connect termination	Catalog number, PCB-mount termination
	V-DC			
 2 NO / 2 NC	12	KC6-22Z-07	KC6-22Z-F07	KC6-22Z-P07
	24	KC6-22Z-01	KC6-22Z-F01	KC6-22Z-P01
	48	KC6-22Z-16	KC6-22Z-F16	KC6-22Z-P16
	60	KC6-22Z-13	KC6-22Z-F13	KC6-22Z-P13
	110...125	KC6-22Z-04	KC6-22Z-F04	KC6-22Z-P04
	220...240	KC6-22Z-05	KC6-22Z-F05	KC6-22Z-P05
 3 NO / 1 NC	12	KC6-31Z-07	KC6-31Z-F07	KC6-31Z-P07
	24	KC6-31Z-01	KC6-31Z-F01	KC6-31Z-P01
	48	KC6-31Z-16	KC6-31Z-F16	KC6-31Z-P16
	60	KC6-31Z-13	KC6-31Z-F13	KC6-31Z-P13
	110...125	KC6-31Z-04	KC6-31Z-F04	KC6-31Z-P04
	220...240	KC6-31Z-05	KC6-31Z-F05	KC6-31Z-P05
 4 NO	12	KC6-40E-07	KC6-40E-F07	KC6-40E-P07
	24	KC6-40E-01	KC6-40E-F01	KC6-40E-P01
	48	KC6-40E-16	KC6-40E-F16	KC6-40E-P16
	60	KC6-40E-13	KC6-40E-F13	KC6-40E-P13
	110...125	KC6-40E-04	KC6-40E-F04	KC6-40E-P04
	220...240	KC6-40E-05	KC6-40E-F05	KC6-40E-P05

6

Main dimensions mm, inches

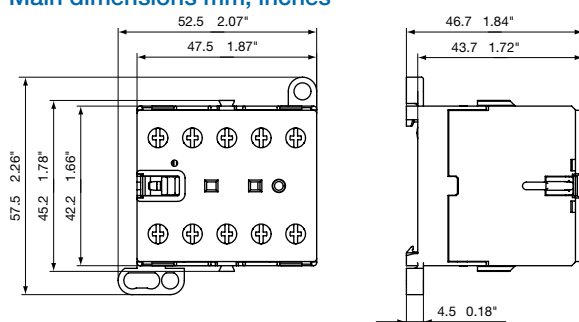

KC6, KC6...F

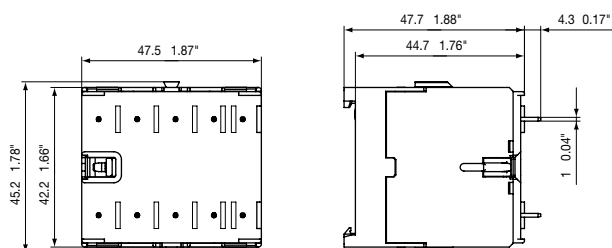

KC6...P

KC6 interface relays, 4 pole

For interface applications up to 4 A
Low power consumption, DC operated coils



Description

KC6 4-pole interface mini contactor relays are space optimized control products mainly used for control functions or for small loads up to 4 A.

These contactors are designed with:

- 4 poles with various contact combinations
- control circuit: DC operated, low coil consumption (1.4 ... 2.8 W at pull-in and at holding)
- hum-free coil
- no auxiliary contact block permitted for mounting
- designed for rail or wall mounting

Ordering details

Rated control circuit voltage U_c	Auxiliary contacts fitted		Catalog number, screw termination	Catalog number, quick-connect termination	Catalog number, PCB-mount termination
					
VDC					
DC operation 24 V / 1.4 W					
24	3	1	KC6-31Z-1.4	KC6-31Z-F1.4	KC6-31Z-P1.4
24	4	0	KC6-40E-1.4	KC6-40E-F1.4	KC6-40E-P1.4
DC operation 17...32 V / 2.4 W					
17...32 (1)	3	1	KC6-31Z-2.4	KC6-31Z-F2.4	KC6-31Z-P2.4
17...32 (1)	4	0	KC6-40E-2.4	KC6-40E-F2.4	KC6-40E-P2.4
DC operation 24 V / 1.7 W					
24	2	2	K6S-22Z-1.7	K6S-22Z-F1.7	K6S-22Z-P1.7
24	3	1	K6S-31Z-1.7	K6S-31Z-F1.7	K6S-31Z-P1.7
24	4	0	K6S-40E-1.7	K6S-40E-F1.7	K6S-40E-P1.7
DC operation 17...32 V / 2.8 W					
17...32 (1)	2	2	K6S-22Z-2.8	K6S-22Z-F2.8	K6S-22Z-P2.8
17...32 (1)	3	1	K6S-31Z-2.8	K6S-31Z-F2.8	K6S-31Z-P2.8
17...32 (1)	4	0	K6S-40E-2.8	K6S-40E-F2.8	K6S-40E-P2.8

(1) U_c min. and U_c max. limit values, including the voltage variation tolerances (-15 % and +10 %).

Main dimensions mm, inches

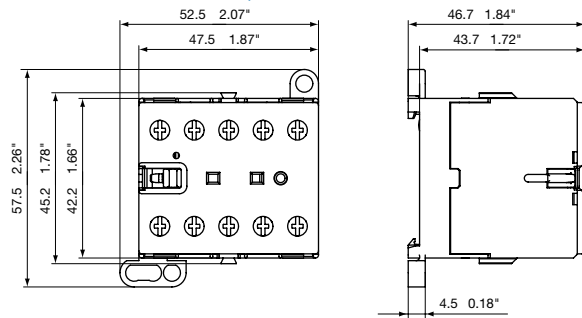

KC6, KC6...F

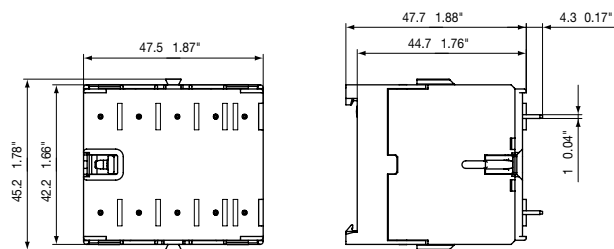

K6...P



KC6



KC6...F



KC6...P

NF(Z), 4 & 8 pole

Accessory fitting details

Contactor relays and main accessories (other accessories available)

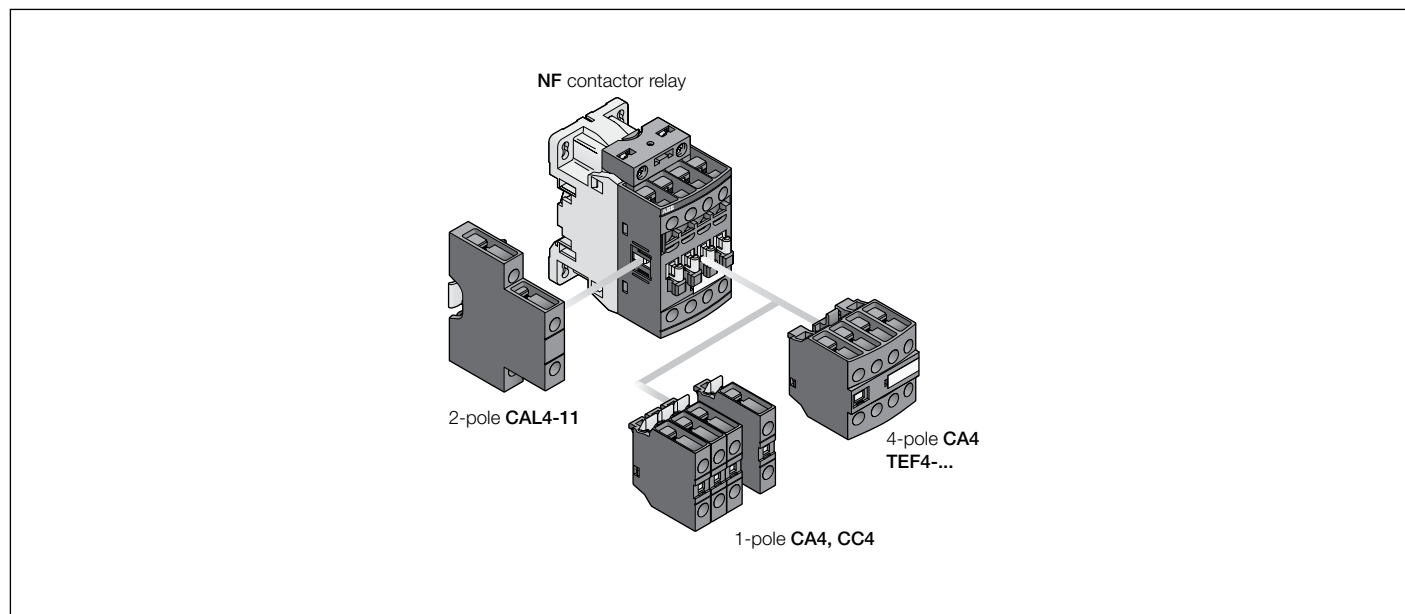

6

Accessory fitting details for a NF control relay

Many configurations of accessories are possible depending on whether these are front-mounted or side-mounted.

Control relay types	Main poles	Front-mounted accessories			Side-mounted accessories	
		Auxiliary contact blocks		Timers	Auxiliary contact blocks	
		1-pole CA4 / 1-pole CC4	4-pole CA4	TEF4-...	Left side 2-pole CAL4-11	Right side
		Max. add-on N.C. auxiliary contacts: 3 N.C. max. on positions 1, 2, 3, 4 and 2 N.C. max. on positions 1 ±30°, 5				
NF..	2 2 E	4 max.	or 1	or 1	+ 1	-
NF..	3 1 E	2 max.	-	-	+ 1	+ 1
		Max. add-on N.C. auxiliary contacts: 4 N.C. max. on positions 1, 2, 3, 4 and 3 N.C. max. on positions 1 ±30°, 5				
NF..	4 0 E	4 max.	or 1	or 1	+ 1	-
		2 max.	-	-	+ 1	+ 1
NF..	4 4 E					
NF..	5 3 E					
NF..	6 2 E	-	-	-	1	-
NF..	7 1 E					
NF..	8 0 E					

NS/L 4 & 8 pole, screw terminated Accessory fitting details

Contactor relays and main accessories (other accessories available)

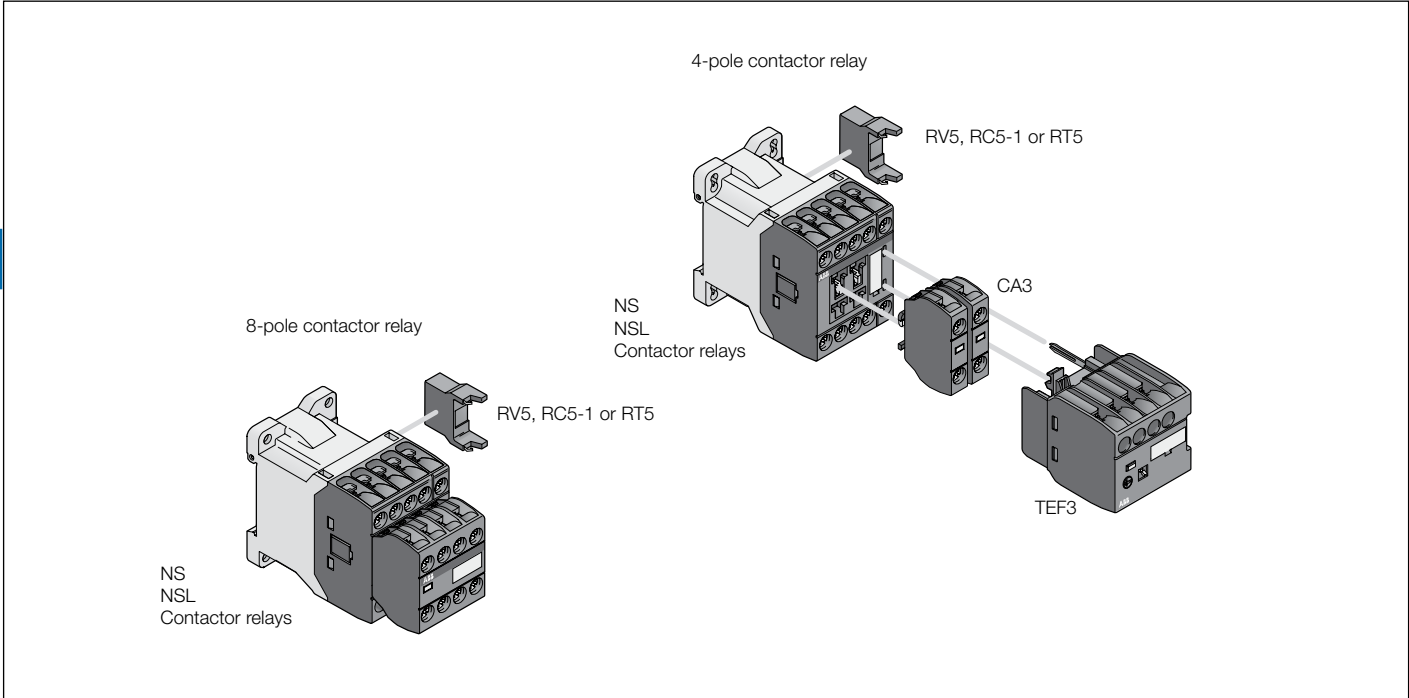

Main accessory fitting details

Contactor types	Main poles 	Front-mounted accessories			Side-mounted accessories	
		Auxiliary contact blocks	Electronic timer		Surge suppressors	
		1-pole CA3	TEF3			
NS..	2 2 E	2 max.	or 1	+	RV5	or RC5-1
NS..	3 1 E					
NS..	4 0 E					
NS..	4 4 E	-	-		RV5	or RC5-1
NS..	5 3 E					
NS..	6 2 E					
NS..	7 1 E					
NS..	8 0 E					
NSL..	2 2 E	2 max.	or 1	+	RV5	or RT5
NSL..	3 1 E					
NSL..	4 0 E					
NSL..	4 4 E	-	-		RV5	or RT5
NSL..	5 3 E					
NSL..	6 2 E					
NSL..	7 1 E					
NSL..	8 0 E					

NS/L 4 & 8 pole, spring terminated

Accessory fitting details

Contactor relays and main accessories

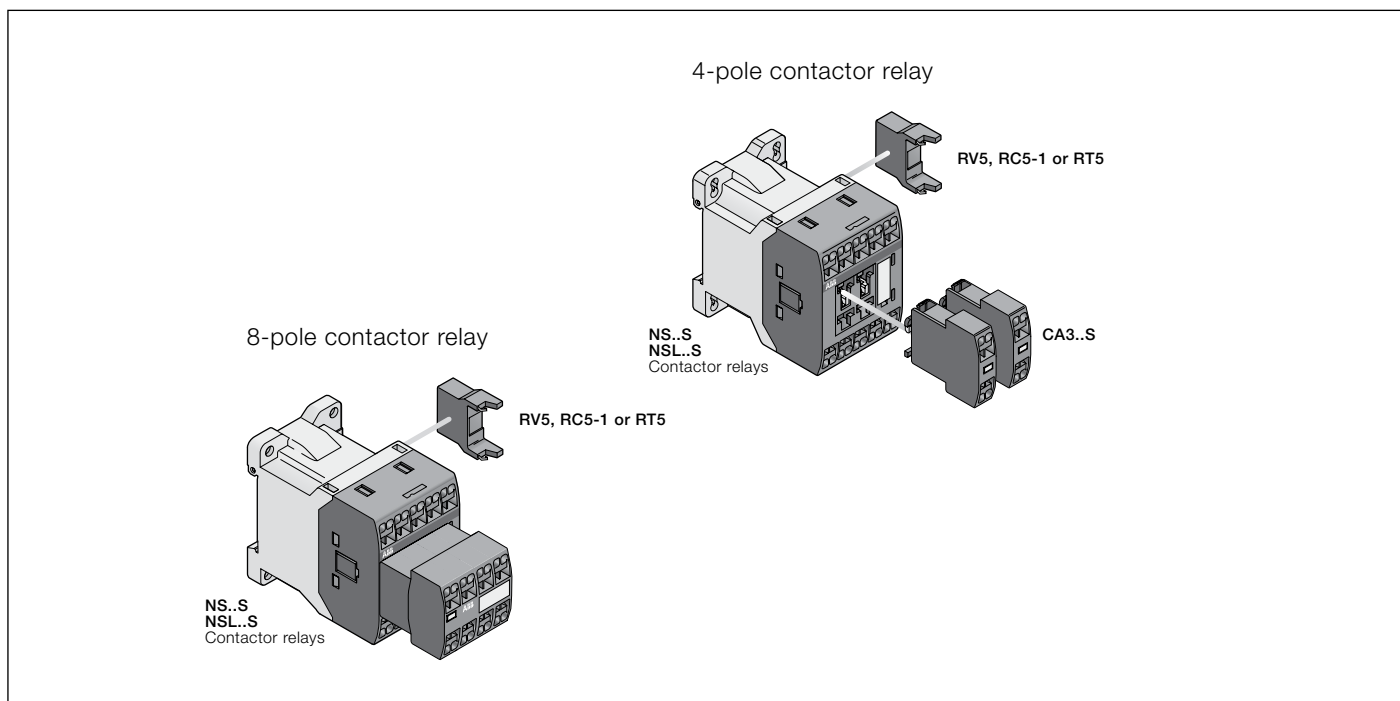

6

Main accessory fitting details

Contactor types	Main poles	Front-mounted accessories		Side-mounted accessories		
		Auxiliary contact blocks		Surge suppressors		
NS..S	2 2 E	1-pole CA3..S	2 max.	+	RV5	or RC5-1
NS..S	3 1 E					
NS..S	4 0 E					
NS..S	4 4 E	-			RV5	or RC5-1
NS..S	5 3 E					
NS..S	6 2 E					
NS..S	7 1 E					
NS..S	8 0 E					
NSL..S	2 2 E	1-pole CA3..S	2 max.	+	RV5	or RT5
NSL..S	3 1 E					
NSL..S	4 0 E					
NSL..S	4 4 E	-			RV5	or RT5
NSL..S	5 3 E					
NSL..S	6 2 E					
NSL..S	7 1 E					
NSL..S	8 0 E					

Auxiliary contact blocks & interlocks

NF(Z), NS/L & K/C6



CA4-10 CA4-22N



CAL4-11 CA3-10



CAF6-11K



CA6-11K



CA6-11K-P



VM4



BB4

Ordering details (1)

For contactor relays	Auxiliary contacts		Catalog number

Front-mounted instantaneous auxiliary contact blocks

	NF(Z)	NS/L	K/C6	Catalog number
NF(Z), 4-pole	1	0	-	CA4-10
	0	1	-	CA4-01
	4	0	-	CA4-40N
	3	1	-	CA4-31N
	2	2	-	CA4-22N
NF(Z)40E only	1	3	-	CA4-13N
	0	4	-	CA4-04N
NS/L, 4-pole	1	0	-	CA3-10
	0	1	-	CA3-01
NS/L, 4-pole, spring terminated	1	0	-	CA3-10S
	0	1	-	CA3-01S
K/C6, 4-pole	1	1	-	CAF6-11K
	2	0	-	CAF6-20K
	0	2	-	CAF6-02K

Front-mounted auxiliary contact blocks with N.O. leading (early make) contact & N.C. lagging (late break) contact

NF(Z), 4-pole	N.O.	N.C.	Catalog number
-	-	1	CC4-10
-	-	0	CC4-01

Side-mounted instantaneous auxiliary contact blocks

	NF(Z)	NS/L	K/C6	Catalog number
NF(Z), 4- & 8-pole	1	1	-	CAL4-11
K/C6, 4-pole	1	1	-	CA6-11K
K/C6...F, 4-pole	1	1	-	CA6-11K-F
K/C6...P, 4-pole	1	1	-	CA6-11K-P

Mechanical interlocks

For control relays		Catalog number
Left side	Right side	
NF(Z)	NF(Z)	VM4
NS/L	NS/L	VM3

NOTE: Includes two fixing clips.

Mechanical & electrical interlocks

For control relays		Catalog number
Left side	Right side	
NF(Z)	NF(Z)	VEM4

Fixing clips

For control relays		Catalog number
NF(Z)	NS/L	
NF(Z)		BB4
	NS/L	BB3

1) See accessory fitting details for maximum quantities.

Surge suppression for control relay coils

NS/L & K/C6

NOTE: Surge suppression integral for NF / NFZ and AC operated K6 control relays; no accessory required.

Description

The operation of inductive circuits causes overvoltages, in particular on opening the contactor coil. The electromagnetic energy stored in the coil during contactor closing is restored on opening in the form of surges, the slope and amplitude of which may rise to several kilovolts. A number of drawbacks are observed ranging from interference on the electronic devices to the breakdown of insulators and even the destruction of certain sensitive components. The graph opposite reproduces the oscillogram showing voltage discharges at the terminals of a 42 V / 50 Hz coil without peak clipping. The coil was switched by 8 series-connected poles of a contactor relay. Following a burst of discharges with a very steep slope, a damped oscillation emerges with a peak value of 3500 V.

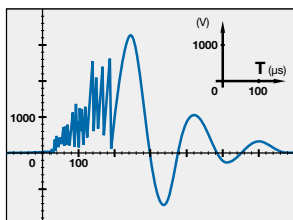

Overvoltage Factor

The overvoltage factor k is defined as the ratio of the maximum overvoltage peak value \hat{U}_s to the peak value \hat{U}_c of the coil rated control voltage U_c :

$$k = \frac{\hat{U}_s \text{ max.}}{\hat{U}_c} \quad \text{in DC} \quad k = \frac{\hat{U}_s \text{ max.}}{U_c} \quad \text{in AC} \quad k = \frac{\hat{U}_s \text{ max.}}{U_c \sqrt{2}}$$

For example the following is obtained for the above graph: $k = \frac{3500}{42 \sqrt{2}} \approx 60$

To reduce the harmful effects of these overvoltages, ABB has developed a range of surge suppressors designed to reduce the k factor defined above and to limit or even completely eliminate the high pre-damping voltage frequencies. Each case is different, but the technical data tolerances and generous sizing of parts have enabled us to reduce the number of variants.

We have chosen the following solutions: transil diodes, varistors and RC blocks.

Note: A varistor is a resistor whose value decreases to a very large extent when a certain voltage is applied at its terminals.



RV5



RC5-1



RT5

Ordering details

For contactor relays	Rated control circuit voltage - U_c			Catalog number
	V	AC	DC	
NS, NSL	24...50	●	●	RV5/50
	50...133	●	●	RV5/133
	110...250	●	●	RV5/250
	250...440	●	●	RV5/440
NS	24...50	●	-	RC5-1/50
	50...133	●	-	RC5-1/133
	110...250	●	-	RC5-1/250
	250...440	●	-	RC5-1/440
NSL	12...32	-	●	RT5/32
	25...65	-	●	RT5/65
	50...90	-	●	RT5/90
	77...150	-	●	RT5/150
KC6	150...264	-	●	RT5/264
	24...60	-	●	RV-BC6/60
KC6...F (2.8mm)	50...250	-	●	RV-BC6/250
	380	-	●	RV-BC6/380
	24...60	-	●	RV-BC6-F/60
	50...250	-	●	RV-BC6-F/250
	380	-	●	RV-BC6-F/380

Main dimensions mm, inches



RV-BC6/250

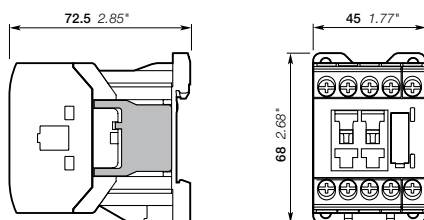

Easy connection to the coil terminals
(parallel mounting)
Clip-on for both fixing and connection.

No additional space
Clipped onto the right side part of the contactor base without changing contactor overall dimensions and keeping a free access to coil terminals.

Electronic timers NF(Z) & NS/L, 4 pole

Ordering details

For contactors, contactor relays	Time delay range selected by switch	Delay type	Rated control circuit voltage U_c V 50/60 Hz or DC	Auxiliary contacts	Catalog number
NS(L)	0.1...1 s	ON-delay	24...240	1 1	TEF3-ON
		OFF-delay	24...240	1 1	TEF3-OFF
NF(Z)	1...10 s	ON-delay	24...240	1 1	TEF4-ON
		OFF-delay	24...240	1 1	TEF4-OFF
	10...100 s				



TEF3



TEF4

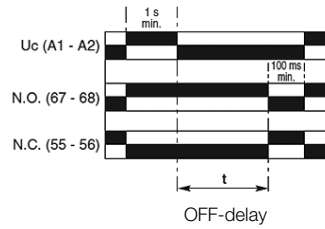
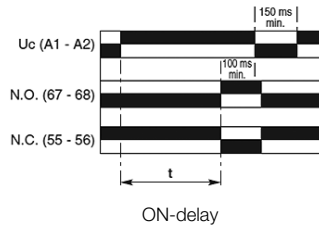

Function markers, protective covers & coil terminal blocks

NF(Z), NS/L & K/C6



LDC4



BX4



LT6-B



BA4

Ordering details

For control relays	Catalog number
--------------------	----------------

Additional coil terminal block

Additional coil terminal block for a bottom access to the coil terminals of contactors or contactor relays.

NF	LDC4
----	------

Protective covers

Sealable and transparent protective covers BX4 and non-removable BX4-CA to protect the devices against accidental contact.

All 1-stack contactors and contactor relays	BX4
For 4-pole CA4 and 2-pole CAT4 auxiliary contact blocks	BX4-CA
For control relays K/C6	LT6-B

Function markers

Box of 16 blank cards (16 markers by card) printable on HTP500 thermal transfer printer and AMS 500 marking table to identify your contactors, overload relays or manual motor starters.

Marker dimensions: 7 x 20 mm (.276" x .787").

Box of 16 blank cards	BA4
AMS 500 support plate for 8 BA4	XUSP02633
HTP500 support plate	1SNA235712R2400

Terminal marking & positioning

NF(Z), 4 & 8 pole

Control relays

Standard devices without addition of auxiliary contacts

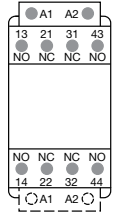

NF(Z)22E

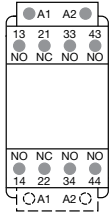

NF(Z)31E

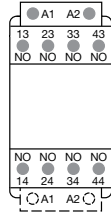

NF(Z)40E

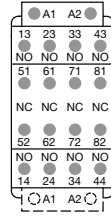

NF(Z)44E

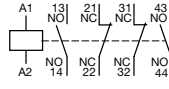

NF(Z)22E

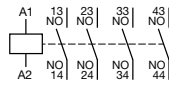

NF(Z)40E

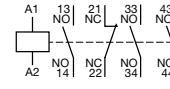

NF(Z)31E

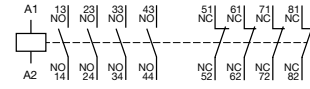

NF(Z)44E

6

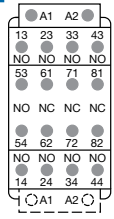

NF(Z)53E

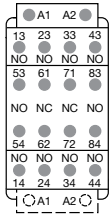

NF(Z)62E

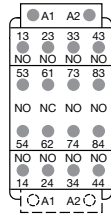

NF(Z)71E

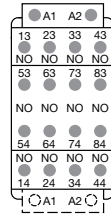

NF(Z)80E

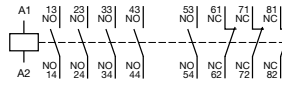

NF(Z)53E

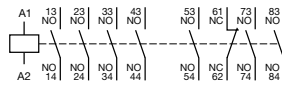

NF(Z)71E

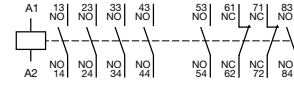

NF(Z)62E

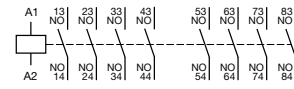

NF(Z)80E

Other possible contact combinations with auxiliary contacts

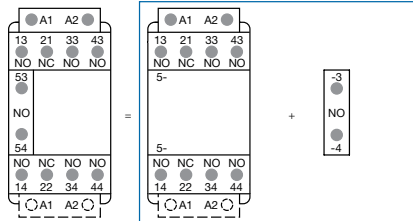

Combination 41 = NF(Z)31E + CA4-10

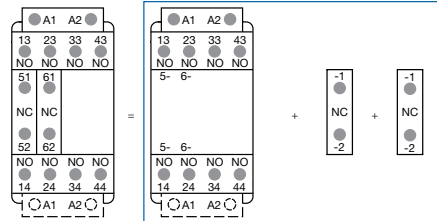

Combination 42 = NF(Z)40E + CA4-01+CA4-01

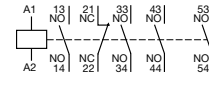

Combination 41 E

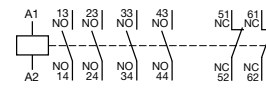

Combination 42 E

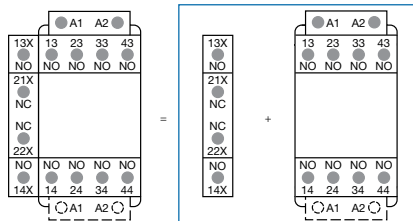

Combination 51 = CAL4-11 + NF(Z)40E

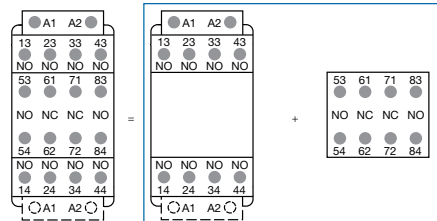

Combination 62 = NF(Z)40E + CA4-22N

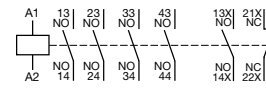

Combination 51 E

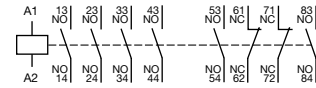

Combination 62 E

Note: Only NF(Z)Z contactor relays with DC control voltage 12...20 V DC need to respect the connection polarities indicated close to the coil terminals: A1+ for the positive pole and A2- for the negative pole.

Terminal marking & positioning

CA4, CC4, CAL4 & CAT4

Auxiliary contacts

1-pole auxiliary contacts

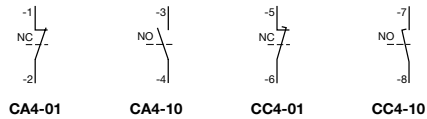

2-pole auxiliary contacts

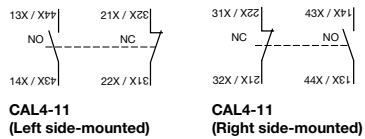

4-pole auxiliary contacts

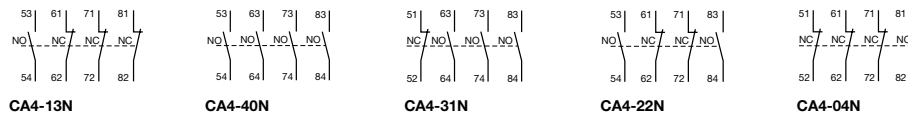

Terminal marking & positioning

NS/L 4 & 8 pole & CA3

Control relays & auxiliary contacts

Standard devices without addition of auxiliary contact blocks

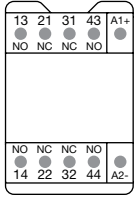

NS/L22E/S

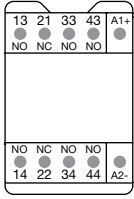

NS/L31E/S

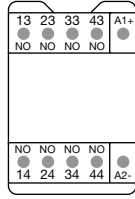

NS/L40E/S

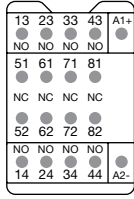

NS/L44E/S

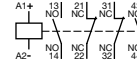

NS/L22E/S

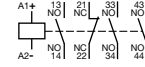

NS/L31E/S

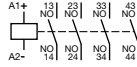

NS/L40E/S

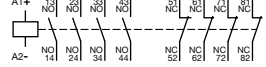

NS/L44E/S

6

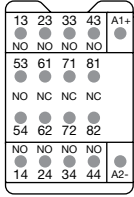

NS/L53E/S

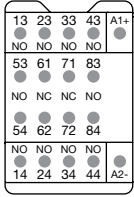

NS/L62E/S

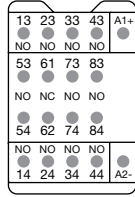

NS/L71E/S

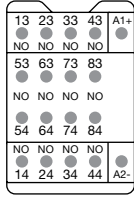

NS/L80E/S

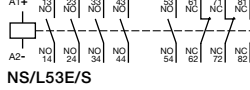

NS/L53E/S

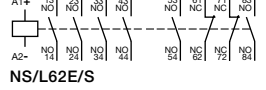

NS/L62E/S



NS/L71E/S



NS/L80E/S

NOTE: For DC operated devices, polarity A1+, A2- must be respected.

Other possible contact combinations with auxiliary contact blocks added by the user

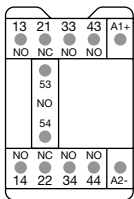

Combination 41E = NS/L31E/S + CA3-10/S

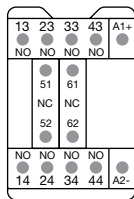
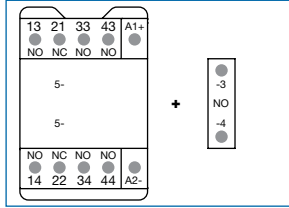

Combination 42E = NS/L40E/S + CA3-10/S + CA3-01/S

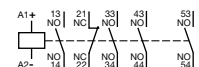
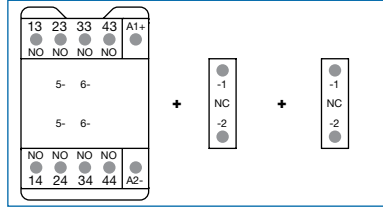

Combination 41E



Combination 42E

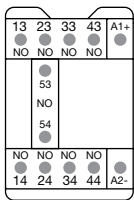

Combination 50E = NS/L40E/S + CA3-10/S

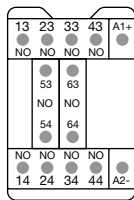
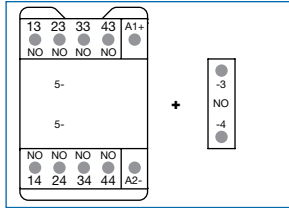

Combination 60E = NS/L40E/S + CA3-10/S + CA3-10/S

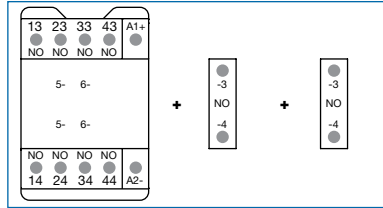

Combination 50E



Combination 60E

1-pole auxiliary contact blocks

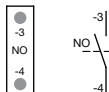

CA3-10/S



CA3-01/S

Terminal marking & positioning

K/C6, CA6 & CAF6

Control relays & auxiliary contacts

Miniature control relays

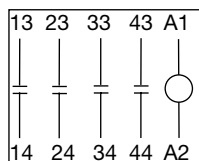

K6-40 E ...
KC6-40 E ...

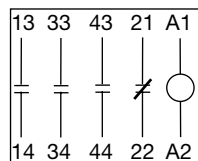

K6-31 Z ...
KC6-31 Z ...

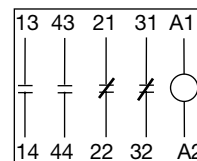

K6-22 Z ...
KC6-22 Z ...

Side mounted auxiliary contact blocks

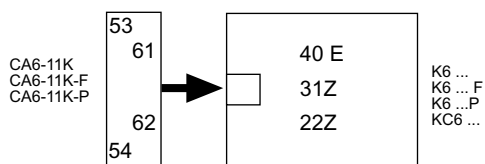

Front mounted auxiliary contact blocks

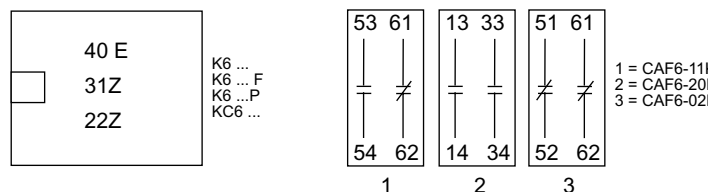

NOTE: Only side mounted type or front mounted type auxiliary contact blocks can be used at one time. Auxiliary contact blocks must not be mounted on Interface contactors, Interface control relays or contactors for connection to PLCs. Two CAF 6 front mounted auxiliary contact blocks can be installed on the mechanically interlocked contactors VB(C)6(7).

IEC / UL / CSA technical data

NF(Z), 4 & 8 pole

Utilization characteristics

Contact utilization characteristics according to IEC

Contactor relay types	AC / DC operated	NF(Z)
Standards		IEC 60947-1 / 60947-5-1 and EN 60947-1 / 60947-5-1
Rated operational voltage U _e max.		690 V
Rated frequency (without derating)		50 / 60 Hz
Conventional free-air thermal current I _{th} θ ≤ 40 °C		16 A
I _e / Rated operational current AC-15		
acc. to IEC 60947-5-1	24-127 V 50/60 Hz	6 A
	220-240 V 50/60 Hz	4 A
	400-440 V 50/60 Hz	3 A
	500 V 50/60 Hz	2 A
	690 V 50/60 Hz	2 A
Rated making capacity AC-15		10 x I _e AC-15 acc. to IEC 60947-5-1
Rated breaking capacity AC-15		10 x I _e AC-15 acc. to IEC 60947-5-1
I _e / Rated operational current DC-13		
acc. to IEC 60947-5-1	24 V DC	6 A / 144 W
	48 V DC	2.8 A / 134 W
	72 V DC	1 A / 72 W
	110 V DC	0.55 A / 60 W
	125 V DC	0.55 A / 69 W
	220 V DC	0.27 A / 60 W
	250 V DC	0.27 A / 68 W
	400 V DC	0.15 A / 60 W
	500 V DC	0.13 A / 65 W
	600 V DC	0.1 A / 60 W
Short-circuit protection device gG type fuse		10 A
Rated short-time withstand current I _{sc}	for 1.0 s	100 A
	for 0.1 s	140 A
Minimum switching capacity		12 V / 3 mA
with failure rate acc. to IEC 60947-5-4		10 ⁻⁷
Non-overlapping time between N.O. and N.C. contacts		≥ 2 ms
Power dissipation per pole at 6 A		0.1 W
Max. electrical switching frequency	AC-15	1200 cycles/h
	DC-13	900 cycles/h
Mechanically linked contacts		Built-in N.O. or N.C. auxiliary contacts and additional N.O. or N.C. auxiliary contacts (CA4, CAL4 aux. contact blocks) are mechanically linked contacts.
acc. to annex L of IEC 60947-5-1		

Contact utilization characteristics according to UL / CSA

Contactor relay types	AC / DC operated	NF(Z)
Standards		UL 508, CSA C22.2 N°14
Max. operational voltage		600 V AC, 600 V DC
Pilot duty		A600, Q600
AC thermal rated current		10 A
AC maximum volt-ampere making		7200 VA
AC maximum volt-ampere breaking		720 VA
DC thermal rated current		2.5 A
DC maximum volt-ampere making-breaking		69 VA

General technical data

NF(Z) 4 & 8 pole

Coil, mounting & operating characteristics

General technical data

Contactor types	AC / DC operated	NF(Z)
Rated insulation voltage U_i		
acc. to IEC 60947-5-1		690 V
acc. to UL / CSA		600 V
Rated impulse withstand voltage U_{imp}		6 kV
Electromagnetic compatibility		Devices complying with IEC 60947-1 / EN 60947-1 - Environment A
Ambient air temperature close to contactor		
Operation in free air		-40...+70 °C
Storage		-60...+80 °C
Climatic withstand		Category B according to IEC 60947-1 Annex Q
Maximum operating altitude (without derating)		3000 m
Mechanical durability		
Number of operating cycles		20 millions operating cycles
Max. switching frequency		6000 cycles/h
Shock withstand		
acc. to IEC 60068-2-27 and EN 60068-2-27		
Mounting position 1		
	Shock direction	1/2 sinusoidal shock for 11 ms: no change in contact position, closed or open position
	A	30 g
	B1	25 g closed position / 5 g open position
	B2	15 g
	C1	25 g
	C2	25 g
Vibration withstand		
acc. to IEC 60068-2-6		5...300 Hz
		4 g closed position / 2 g open position

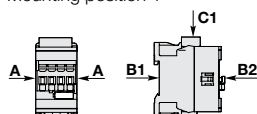

Magnet system characteristics

Contactor relay types	AC / DC operated	NF(Z)
Coil operating limits	AC supply	At $\theta \leq 60$ °C $0.85 \times U_c \text{ min...} 1.1 \times U_c \text{ max.}$
acc. to IEC 60947-5-1		At $\theta \leq 70$ °C $0.85 \times U_c \text{ min...} U_c \text{ max.}$
	DC supply	At $\theta \leq 60$ °C $0.85 \times U_c \text{ min...} 1.1 \times U_c \text{ max.}$
		At $\theta \leq 70$ °C (AF) $0.85 \times U_c \text{ min...} U_c \text{ max.}$ - (NFZ) $0.85 \times U_c \text{ min...} 1.1 \times U_c \text{ max.}$
AC control voltage	Rated control circuit voltage U_c	24...500 V AC
50/60 Hz	Coil consumption	
	Average pull-in value	(NF) 50 VA - (NFZ) 16 VA
	Average holding value	(NF) 2.2 VA / 2 W - (NFZ) 1.7 VA / 1.5 W
DC control voltage	Rated control circuit voltage U_c	12...500 V DC
	Coil consumption	
	Average pull-in value	(NF) 50 W - (NFZ) 12...16 W
	Average holding value	(NF) 2 W - (NFZ) 1.7 W
PLC-output control		(NFZ) ≥ 500 mA 24 V DC
Drop-out voltage		≤ 60 % of $U_c \text{ min.}$
Voltage sag immunity acc. to SEMI F47-0706		(NFZ) conditions of use on request
Dips withstand		
-20 °C $\leq \theta \leq$ +60 °C		(NFZ) 22 ms average
Operating time		
Between coil energization and:	N.O. contact closing	40...95 ms
	N.C. contact opening	38...90 ms
Between coil de-energization and:	N.O. contact opening	11...95 ms
	N.C. contact closing	13...98 ms

Mounting characteristics









Contactor types	AC / DC operated	NF(Z)
Mounting positions		
		Max. add-on N.C. auxiliary contacts: see accessory fitting details for a NF contactor relay
Mounting distances		The contactor relays can be assembled side by side.
Fixing	On rail according to IEC 60715, EN 60715	35 x 7.5 mm or 35 x 15 mm
	By screws (not supplied)	2 x M4 screws placed diagonally

General technical data

NF(Z), 4 & 8 pole

Terminal characteristics

Connecting characteristics

Contactor types	AC / DC operated	NF(Z)
Main terminals		
		Screw terminals with cable clamp
Connection capacity (min. ... max.)		
Pole and coil terminals		
	Rigid	1 x 1...2.5 mm ²
		2 x 1...2.5 mm ²
	Flexible with non insulated ferrule	1 x 0.75...2.5 mm ²
		2 x 0.75...2.5 mm ²
	Flexible with insulated ferrule	1 x 0.75...2.5 mm ²
		2 x 0.75...1.5 mm ²
	Lugs	L < 8 mm
Connection capacity acc. to UL/CSA		1 or 2 x AWG 18...14
Stripping length		10 mm
Tightening torque		
Pole terminals		1.2 Nm / 11 lb.in
Coil terminals		1.2 Nm / 11 lb.in
Degree of protection		
acc. to IEC 60947-1 / EN 60947-1 and IEC 60529 / EN 60529		
All terminals		IP20
Screw terminals		
All terminals		Delivered in open position, screws of unused terminals must be tightened
		M3.5
Screwdriver type		Flat Ø 5.5 / Pozidriv 2

IEC / UL / CSA technical data

NS/L, 4 & 8 pole, screw terminated

Utilization characteristics

Contact utilization characteristics according to IEC

Contactor relay types	AC operated	NS
	DC operated	NSL
Standards	IEC 60947-5-1 and EN 60947-5-1	
Rated operational voltage U_e max.	690 V	
Rated frequency (without derating)	50 / 60 Hz	
Conventional free-air thermal current $I_{th} - \theta \leq 40$ °C	10 A	
I_e / Rated operational current AC-15		
acc. to IEC 60947-5-1	24-127 V 50/60 Hz	6 A
	220-240 V 50/60 Hz	4 A
	400-440 V 50/60 Hz	3 A
	500 V 50/60 Hz	2 A
	690 V 50/60 Hz	2 A
Making capacity AC-15	10 x I_e AC-15 acc. to IEC 60947-5-1	
Breaking capacity AC-15	10 x I_e AC-15 acc. to IEC 60947-5-1	
I_e / Rated operational current DC-13		
acc. to IEC 60947-5-1	24 V DC	6 A / 144 W
	48 V DC	2.8 A / 134 W
	72 V DC	1 A / 72 W
	110 V DC	0.55 A / 60 W
	125 V DC	0.55 A / 69 W
	220 V DC	0.27 A / 60 W
	250 V DC	0.27 A / 68 W
Short-circuit protection device for contactors		
$U_e \leq 500$ V AC - gG type fuse	10 A	
Rated short-time withstand current I_{sw}	for 1.0 s	100 A
	for 0.1 s	140 A
Minimum switching capacity	12 V / 3 mA	
with failure rate acc. to IEC 60947-5-4	10 ⁻⁷	
Non-overlapping time between N.O. and N.C. contacts	1.5 ms	
Power dissipation per pole at 6 A	0.1 W	
Max. electrical switching frequency	AC-15	1200 cycles/h
	DC-13	900 cycles/h
Mechanically linked contacts	Built-in N.O. or N.C. auxiliary contacts and additional N.O. or N.C. auxiliary contacts (CA3 aux. contact blocks) are mechanically linked contacts.	
acc. to annex L of IEC 60947-5-1		

Contact utilization characteristics according to UL / CSA

Contactor relay types	AC operated	NS
	DC operated	NSL
Standards	UL 508, CSA C22.2 N°14	
Max. operational voltage	600 V AC, 250 V DC	
Pilot duty	A600, Q300	
AC thermal rated current	10 A	
AC maximum volt-ampere making	7200 VA	
AC maximum volt-ampere breaking	720 VA	
DC thermal rated current	2.5 A	
DC maximum volt-ampere making-breaking	69 VA	

General technical data

NS/L, 4 & 8 pole, screw terminated

Coil & mounting characteristics

Magnet system characteristics for NS contactor relays

Contactor relay types	AC operated	NS	
Coil operating limits acc. to IEC 60947-5-1	AC supply		
AC control voltage	Rated control circuit voltage U_c	0.85...1.1 x U_c (at $\theta \leq 60^\circ\text{C}$); U_c (at $\theta \leq 70^\circ\text{C}$)	
	at 50 Hz	24...415 V	
	at 60 Hz	24...415 V	
Coil consumption	Average pull-in value	50 Hz	33 VA
		60 Hz	33 VA
		50/60 Hz	33 VA
	Average holding value	50 Hz	6.5 VA / 1.5 W
		60 Hz	5 VA / 1.2 W
50/60 Hz		6.5 VA / 1.5 W	
Drop-out voltage		Approx. 30...50 % of U_c	
Operating time			
Between coil energization and:	N.O. contact closing	9...24 ms	
	N.C. contact opening	6...18 ms	
Between coil de-energization and:	N.O. contact opening (1)	5...19 ms	
	N.C. contact closing (1)	7...22 ms	
		(1) The use of RC5-1 surge suppressor increases opening time by a factor of 2 to 3.	

Magnet system characteristics for NSL contactor relays

Contactor relay types	DC operated	NSL	
Coil operating limits acc. to IEC 60947-5-1	DC supply		
DC control voltage	Rated control circuit voltage U_c	0.85...1.1 x U_c (at $\theta \leq 60^\circ\text{C}$); U_c (at $\theta \leq 70^\circ\text{C}$)	
	Coil consumption	12...240 V DC	
	Average pull-in value	3 W	
	Average holding value	3 W	
Drop-out voltage		Approx. 10...40 % of U_c	
Coil time constant	Open	L/R	12 ms
	Closed	L/R	40 ms
Operating time			
Between coil energization and:	N.O. contact closing	36...59 ms	
	N.C. contact opening	31...53 ms	
Between coil de-energization and:	N.O. contact opening (1)	13...17 ms	
	N.C. contact closing (1)	15...20 ms	
		(1) The use of RT5 surge suppressor increases opening time by a factor of 1.1 to 1.2.	

Mounting characteristics and conditions for use

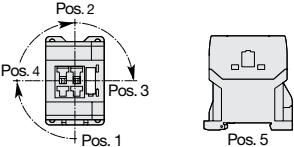
Contactor relay types	AC operated	NS
	DC operated	NSL
Mounting positions		
Mounting distances	The contactor relays can be assembled side by side.	
Fixing	On rail according to IEC 60715, EN 60715	35 x 7.5 mm or 35 x 15 mm
	By screws (not supplied)	2 x M4 screws placed diagonally

General technical data

NS/L, 4 & 8 pole, screw terminated



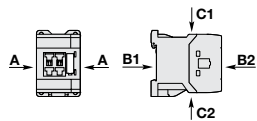

Operating & terminal characteristics

General technical data

Contactor relay types	AC operated	NS
	DC operated	NSL
Rated insulation voltage U_i		
acc. to IEC 60947-5-1		690 V
acc. to UL / CSA		600 V
Rated impulse withstand voltage U_{imp}		6 kV
Ambient air temperature close to contactor relay		
Operation in free air		-40...+70 °C
Storage		-60...+80 °C
Climatic withstand		Category B according to IEC 60947-1 Annex Q
Maximum operating altitude (without derating)		3000 m
Mechanical durability		
Number of operating cycles		20 millions operating cycles
Max. switching frequency		3600 cycles/h
Shock withstand		1/2 sinusoidal shock for 11 ms: no change in contact position, closed or open position
acc. to IEC 60068-2-27 and EN 60068-2-27	Shock direction	NS contactor relays - AC operated NSL contactor relays - DC operated
Mounting position 1	A	20 g 20 g closed position / 10 g open position
	B1	5 g 15 g closed position / 5 g open position
	B2	15 g 10 g
	C1	19 g closed position / 8 g open position 19 g closed position / 8 g open position
	C2	16 g closed position / 13 g open position 14 g closed position / 8 g open position
Vibration withstand acc. to IEC 60068-2-6		5...300 Hz / 3 g closed position / 2 g open position



Connecting characteristics

Contactor relay types	AC operated	NS
	DC operated	NSL
Main terminals		 <p>Screw terminals with cable clamp</p>
Connection capacity (min. ... max.)		
Pole and coil terminals		
 Rigid solid	1 x	0.75...2.5 mm ²
	2 x	0.75...2.5 mm ²
 Flexible with non insulated ferrule	1 x	0.75...2.5 mm ²
	2 x	0.75...2.5 mm ²
 Flexible with insulated ferrule	1 x	0.75...2.5 mm ²
	2 x	0.75...1.5 mm ²
 Lugs	L ≤	7.7 mm
	L >	3.2 mm
Connection capacity acc. to UL / CSA	1 or 2 x	AWG 18...14
Stripping length		9 mm
Tightening torque	Recommended	1.00 Nm / 9 lb.in
	Max.	1.20 Nm
Degree of protection		
acc. to IEC 60947-1 / EN 60947-1 and IEC 60529 / EN 60529		
All terminals		IP20
Screw terminals		Delivered in open position, screws of unused terminals must be tightened
All terminals		M3
	Screwdriver type	Flat Ø 5.5 / Pozidriv 2

IEC / UL / CSA technical data

NS/L, 4 & 8 pole, spring terminated

Utilization characteristics

Contact utilization characteristics according to IEC

Contactor relay types	AC operated	NS..S
	DC operated	NSL..S
Standards	IEC 60947-5-1 and EN 60947-5-1	
Rated operational voltage U_e max.	690 V	
Rated frequency (without derating)	50 / 60 Hz	
Conventional free-air thermal current $I_{th} \theta \leq 40 \text{ }^\circ\text{C}$	10 A	
le / Rated operational current AC-15		
acc. to IEC 60947-5-1	24-127 V 50/60 Hz	6 A
	220-240 V 50/60 Hz	4 A
	400-440 V 50/60 Hz	3 A
	500 V 50/60 Hz	2 A
	690 V 50/60 Hz	2 A
Making capacity AC-15	10 x le AC-15 acc. to IEC 60947-5-1	
Breaking capacity AC-15	10 x le AC-15 acc. to IEC 60947-5-1	
le / Rated operational current DC-13		
acc. to IEC 60947-5-1	24 V DC	6 A / 144 W
	48 V DC	2.8 A / 134 W
	72 V DC	1 A / 72 W
	110 V DC	0.55 A / 60 W
	125 V DC	0.55 A / 69 W
	220 V DC	0.27 A / 60 W
	250 V DC	0.27 A / 68 W
Short-circuit protection device for contactors	10 A	
$U_e \leq 500 \text{ V AC}$ - gG type fuse		
Rated short-time withstand current I_{cw}	for 1.0 s	100 A
at 40 °C ambient temperature, in free air from a cold state	for 0.1 s	140 A
Minimum switching capacity	12 V / 3 mA	
with failure rate acc. to IEC 60947-5-4	10 ⁻⁷	
Non-overlapping time between N.O. and N.C. contacts	1.5 ms	
Power dissipation per pole at 6 A	0.1 W	
Max. electrical switching frequency	AC-15	1200 cycles/h
	DC-13	900 cycles/h
Mechanically linked contacts	Built-in N.O. or N.C. auxiliary contacts and additional N.O. or N.C. auxiliary contacts (CA3..S aux. contact blocks) are mechanically linked contacts.	
acc. to annex L of IEC 60947-5-1		

Contact utilization characteristics according to UL / CSA

Contactor relay types	AC operated	NS..S
	DC operated	NSL..S
Standards	UL 508, CSA C22.2 N°14	
Max. operational voltage	600 V AC, 250 V DC	
Pilot duty	A600, Q300	
AC thermal rated current	10 A	
AC maximum volt-ampere making	7200 VA	
AC maximum volt-ampere breaking	720 VA	
DC thermal rated current	2.5 A	
DC maximum volt-ampere making-breaking	69 VA	

General technical data

NS/L, 4 & 8 pole, spring terminated

Coil & mounting characteristics

Magnet system characteristics for NS..S contactor relays

Contactor relay types	AC operated	NS..S
Coil operating limits	AC supply	
acc. to IEC 60947-5-1		0.85...1.1 x U _c (at $\theta \leq 60^\circ\text{C}$); U _c (at $\theta \leq 70^\circ\text{C}$)
AC control voltage Rated control circuit voltage U _c	at 50 Hz	24...415 V
	at 60 Hz	24...415 V
Coil consumption	Average pull-in value	50 Hz 33 VA
		60 Hz 33 VA
		50/60 Hz 33 VA
	Average holding value	50 Hz 6.5 VA / 1.5 W
		60 Hz 5 VA / 1.2 W
	50/60 Hz 6.5 VA / 1.5 W	
Drop-out voltage		Approx. 30...50 % of U _c
Operating time		
Between coil energization and:	N.O. contact closing	9...24 ms
	N.C. contact opening	6...18 ms
Between coil de-energization and:	N.O. contact opening (1)	5...19 ms
	N.C. contact closing (1)	7...22 ms
(1) The use of RC5-1 surge suppressor increases opening time by a factor of 2 to 3.		

Magnet system characteristics for NSL..S contactor relays

Contactor relay types	DC operated	NSL..S
Coil operating limits	DC supply	
acc. to IEC 60947-5-1		0.85...1.1 x U _c (at $\theta \leq 60^\circ\text{C}$); U _c (at $\theta \leq 70^\circ\text{C}$)
DC control voltage		
Rated control circuit voltage U _c		12...240 V DC
Coil consumption	Average pull-in value	3 W
	Average holding value	3 W
Drop-out voltage		Approx. 10...40 % of U _c
Coil time constant	Open	L/R 12 ms
	Closed	L/R 40 ms
Operating time		
Between coil energization and:	N.O. contact closing	36...59 ms
	N.C. contact opening	31...53 ms
Between coil de-energization and:	N.O. contact opening (1)	13...17 ms
	N.C. contact closing (1)	15...20 ms
(1) The use of RT5 surge suppressor increases opening time by a factor of 1.1 to 1.2.		

Mounting characteristics and conditions for use

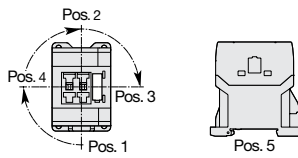
Contactor relay types	AC operated	NS..S
	DC operated	NSL..S
Mounting positions		
Mounting distances	The contactor relays can be assembled side by side.	
Fixing	On rail according to IEC 60715, EN 60715	35 x 7.5 mm or 35 x 15 mm
	By screws (not supplied)	2 x M4 screws placed diagonally

General technical data



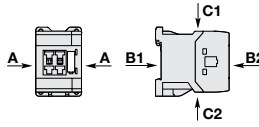

NS/L, 4 & 8 pole, spring terminated

Operating & terminal characteristics

General technical data

Contactor relay types	AC operated	NS..S	
	DC operated	NSL..S	
Rated insulation voltage U_i acc. to IEC 60947-5-1 acc. to UL / CSA		690 V 600 V	
Rated impulse withstand voltage U_{imp}		6 kV	
Ambient air temperature close to contactor relay			
Operation in free air		-40...+70 °C	
Storage		-60...+80 °C	
6 Climatic withstand		Category B according to IEC 60947-1 Annex Q	
Maximum operating altitude (without derating)		3000 m	
Mechanical durability			
Number of operating cycles		20 millions operating cycles	
Max. switching frequency		3600 cycles/h	
Shock withstand acc. to IEC 60068-2-27 and EN 60068-2-27		1/2 sinusoidal shock for 11 ms: no change in contact position, closed or open position	
Mounting position 1	Shock direction		
		NS contactor relays - AC operated	NSL contactor relays - DC operated
	A	20 g	20 g closed position / 10 g open position
	B1	5 g	15 g closed position / 5 g open position
	B2	15 g	10 g
	C1	19 g closed position / 8 g open position	19 g closed position / 8 g open position
	C2	16 g closed position / 13 g open position	14 g closed position / 8 g open position
Vibration withstand acc. to IEC 60068-2-6		5...300 Hz 3 g closed position / 2 g open position	

Connecting characteristics

Contactor relay types	AC operated	NS..S	
	DC operated	NSL..S	
Main terminals		 Spring terminals	
Connection capacity (min. ... max.)			
Pole and coil terminals			
 Rigid solid	1 x	0.75...2.5 mm ²	
	2 x	0.75...2.5 mm ²	
 Flexible with non insulated ferrule	1 x	0.75...2.5 mm ²	
	2 x	0.75...2.5 mm ²	
 Flexible with insulated ferrule	1 x	0.75...1.5 mm ²	
	2 x	0.75...1.5 mm ²	
Connection capacity acc. to UL / CSA	1 or 2 x	AWG 18...14	
Stripping length		10 mm	
Degree of protection acc. to IEC 60947-1 / EN 60947-1 and IEC 60529 / EN 60529		IP20	
All terminals		IP20	
Screwdriver type		Flat Ø 3.5	

IEC / UL / CSA technical data

K/C6, 4 pole

Utilization characteristics

Main pole – Utilization characteristics according to IEC

Contactor types	AC operated	K6
	DC operated	KC6, TKC6
Standards		IEC 60947-1 / 60947-5-1 and EN 60947-1 / 60947-5-1
Rated operational voltage $U_{e\max}$		690 V
Rated frequency (without derating)		DC or 50 / 60 Hz
Conventional free-air thermal current $I_{th} \text{ } \varnothing \leq 40 \text{ } ^\circ\text{C}$		6 A
I_e / Rated operational current AC-15 acc. to IEC 60947-5-1	24 V 50/60 Hz	4 A
	110-120 V 50/60 Hz	4 A
	220-230-240 V 50/60 Hz	4 A
	380-400 V 50/60 Hz	3 A
	440 V 50/60 Hz	3 A
I_e / Rated operational current DC-13 acc. to IEC 60947-5-1	480-500 V 50/60 Hz	2 A
	24 V DC	2.5 A
	110 V DC	0.7 A
	220 - 240 V DC	0.4 A
Short-circuit protection device for contactors $U_e \leq 500 \text{ V AC}$, gG fuse type		6 A
Minimum switching capacity		17 V / 5 mA
Maximum electrical switching frequency	AC-15	600 cycles/h
	DC-13	600 cycles/h

Main pole – Utilization characteristics according to UL / CSA

Contactor types	AC operated	K6
	DC operated	KC6
Standards		UL 508, CSA C22.2 No14
Maximum operational voltage		600 V AC
Pilot duty		A600

General technical data

K/C6, 4 pole

Coil & operating characteristics

General technical data

Contactor relay types	AC operated	K6
	DC operated	KC6
Rated insulation voltage U_i	acc. to IEC 60947-5-1	690 V
	acc. to UL/CSA	600 V
Rated impulse withstand voltage U_{imp}		6 kV
Electromagnetic compatibility		
Ambient air temperature close to contactor relay	Operation in free air	-25 ... +55 °C
	Storage	-40 ... +80 °C
Climatic withstand		acc. to IEC 60068-2-30
Maximum operating altitude (without derating)		2000 m
Mechanical durability		10 ⁷ operating cycles
Resistance to shock		Half-sine
	acc. IEC 60068-2-27 and EN 60068-2-27	15 g / 11ms
	acc. to IEC/EN 60947-1 Annex. Q	Category E
Resistance to vibrations		Sinusoidal
	acc. IEC 60068-2-27 and EN 60068-2-27	5 g / 3 ... 150 Hz
	acc. to IEC/EN 60947-1 Annex. Q	Kategorie E

Magnet system characteristics for K6 contactor relays

Contactor relay types	AC operated	K6
Coil operating limits acc. to IEC 60947-4-1	AC supply	0.85 ... 1.1 x U_C
AC control voltage		
Coil consumption	Average pull-in value	3.5 VA / 3.5 W
	Average holding value	3.5 VA / 3.5 W
Drop-out voltage in % of U_C min.		Approx. 20 ... 75%

Magnet system characteristics for KC6, TKC6 contactor relays

Contactor relay types	DC operated	KC6	TKC6
Coil operating limits acc. to IEC 60947-5-1	DC supply	0.85 ... 1.1 x U_C	See ordering details
DC control voltage			
Coil consumption	Average pull-in value	3.5 VA / 3.5 W	5 VA / 5 W
	Average holding value	3.5 VA / 3.5 W	5 VA / 5 W
Drop-out voltage in % of U_C min.		10 ... 75 %	10 ... 75 %

General technical data

K/C6, 4 pole

Terminal & mounting characteristics

Mounting characteristics and conditions for use

Contactor types	AC operated DC operated	K6 KC6
Mounting positions		
Mounting distances	The contactors can be assembled side by side.	
Fixing	On rail acc. to IEC 60715, EN 60715 By screws (not supplied)	
	35 x 7.5 mm or 35 x 15 mm	2 x M4 screws placed diagonally

Connecting characteristics

Contactor relay types	AC operated DC operated	K6 KC6, TKC6
Main terminals ¹⁾	 Screw terminals with cable clamp	
Connection capacity		
Main conductors (poles)		
Rigid: solid	1 or 2 x	1 ... 4 mm ²
Flexible without ferrule	1 or 2 x	1 ... 2.5 mm ²
Connection capacity acc. to UL/CSA	1 or 2 x	AWG 22 ... 10
Stripping length		9 mm
Tightening torques		0.8 ... 1.1 Nm / 7 lb.in
Degree of protection acc. to IEC 60947-1 / EN 60947-1 and IEC 60529 / EN 60529		
All	IP20	
Screw terminals	(Delivered in open position, screws of unused terminals must be tightened)	
All terminals	M3	
Screwdriver type	Flat Ø 5.5 / Pozidriv 1	

¹⁾ Soldering pin connection acc. to DIN 40801: 0.8 x 1 mm / 0.8 x 2.54 mm

Flat pin connection acc. to DIN 46248: 1 x 6.3 mm / 1 x 2.8 mm

Electronic timers



General information

Electronic timers

Overview



CT-D range

CT-E range

CT-S range

6

Timing function

		multifunctional	single-functional	multifunctional	single-functional	multifunctional	single-functional
	ON-delay	CT-MFD	CT-ERD	CT-MFE, CT-MKE	CT-ERE, CT-EKE	CT-MVS, CT-MFS, CT-MBS, CT-WBS	CT-ERS
	OFF-delay	CT-MFD	CT-AHD	CT-MFE	CT-AHE, CT-ARE, CT-AKE	CT-MVS, CT-MFS, CT-MBS	CT-APS, CT-AHS, CT-ARS, CT-VBS
	ON- and OFF-delay					CT-MVS, CT-MXS, CT-MFS, CT-MBS	
	Impulse-ON	CT-MFD	CT-VWD	CT-MFE, CT-MKE	CT-VWE	CT-MVS, CT-MFS, CT-MBS, CT-WBS	
	Impulse-OFF	CT-MFD			CT-AWE	CT-MVS, CT-MFS, CT-MBS	
	Impulse-ON and OFF					CT-MXS	
	Flasher starting with ON	CT-MFD	CT-EBD	CT-MFE, CT-MKE		CT-MFS, CT-MBS, CT-WBS	
	Flasher starting with OFF	CT-MFD		CT-MFE, CT-MKE	CT-EBE	CT-MFS, CT-MBS, CT-WBS	
	Flasher starting with ON or OFF					CT-MVS	
	Pulse generator starting with ON or OFF		CT-TGD			CT-MXS	
	Pulse former	CT-MFD		CT-MFE		CT-MVS, CT-MFS, CT-MBS	
	Star-delta change-over		CT-SDD, CT-SAD				CT-SDS
	Star-delta change-over with impulse				CT-SDE	CT-MVS.2x, CT-MFS, CT-MBS	
	Star-delta change-over twice ON-delayed				CT-YDE		
	Further functions (depending on device)					CT-MVS, CT-MXS, CT-MFS, CT-MBS, CT-WBS	
	Switching relay				CT-IRE		CT-IRS

Technical data (extract)

Time ranges	7 (0.05 s - 100 h) CT-SDD, CT-SAD: 4 (0.05 s - 10 min)	Multifunction devices: 8 (0.05 s - 100 h) Single-function devices: 5 single ranges (0.05-1 s, 0.1-10 s, 0.3-30 s, 3-300 s, 0.3-300 min)	10 (0.05 s - 300 h) CT-ARS, CT-SDS: 7 (0.05 s - 10 min)
Control supply voltage	Wide and multi ranges	Wide ranges Single and dual ranges	Wide, multi and single ranges
Type and number of contacts	1 or 2 c/o contacts CT-SDD, CT-SAD: 2 n/o contacts	1 c/ o contact CT-SDE: 1 n/o contact and 1 n/c contacts CT-MKE, CT-EKE, CT-AKE: 1 thyristor	1 or 2 c/o contacts CT-MVS.21, CT-MFS, CT-MBS: 2nd c/o contact selectable as inst. contact CT-SDS: 2 n/o contacts
Control inputs	voltage-related triggering, polarized, capable of switching a parallel load	voltage-related triggering, polarized CT-MFE, CT-AHE, CT-AWE: with auxiliary voltage	voltage-related triggering, non-polarized, capable of switching a parallel load CT-MFS, CT-MBS, CT-AHS: volt-free triggering

General information

Electronic timers

Approvals and marks

■ existing
□ pending

		CT-D																	
Approvals		CT-MFD.12	CT-MFD.21	CT-ERD.12	CT-ERD.22	CT-AHD.12	CT-AHD.22	CT-VWD.12	CT-EBD.12	CT-TGD.12	CT-TGD.22	CT-SDD.22	CT-SAD.22						
	UL 508, CAN/CSA C22.2 No.14	■	■	■	■	■	■	■	■	■	■	■	■						
	GOST	■	■	■	■	■	■	■	■	■	■	■	■						
	CB scheme	■	■	■	■	■	■	■	■	■	■	■	■						
	CCC	■	■	■	■	■	■	■	■	■	■	■	■						
Marks																			
	CE	■	■	■	■	■	■	■	■	■	■	■	■						
	C-Tick	■	□	■	□	■	□	■	■	■	□	□	□						

■ existing
□ pending

		CT-E																	
Approvals		CT-MFE	CT-ERE	CT-AHE	CT-ARE	CT-VWE	CT-AWE	CT-EBE	CT-YDE	CT-SDE	CT-IRE		CT-MKE	CT-EKE	CT-AKE				
	UL 508, CAN/CSA C22.2 No.14	■	■	■	■	■	■	■	■	■	■		■	■	■				
	GL	■	■	■	■	■	■	■	■	■	■		■	■	■				
	GOST	■	■	■	■	■	■	■	■	■	■		■	■	■				
	CB scheme	■	■	■	■	■	■	■	■	■	■								
	CCC	■	■	■	■	■	■	■	■	■	■								
	RMRS	■	■	■	■	■	■	■	■	■	■		■	■	■				
Marks																			
	CE	■	■	■	■	■	■	■	■	■	■		■	■	■				
	C-Tick	■	■	■	■	■	■	■	■	■	■		■	■	■				

■ existing
□ pending

		CT-S																		
Approvals		CT-MVS.12	CT-MVS.2x	CT-MXS.22	CT-MFS.21	CT-MBS.22	CT-WBS.22	CT-EFS.12	CT-EFS.2x	CT-APS.12	CT-APS.2x	CT-AHS.22	CT-ARS.11	CT-ARS.21	CT-VBS.1x	CT-SDS.2x		CT-IRS.1x	CT-IRS.2x	CT-IRS.3x
	UL 508, CAN/CSA C22.2 No.14	■	■	■	■	■	■	■	■	■	■	■	■	■	■	■				
	GL	■	■	■	■	■	■	■	■	■	■	■	□	□		■				
	GOST	■	■	■	■	■	■	■	■	■	■	■	■	■	■	■		■	■	■
	CB scheme	■	■	■	■	■	■	■	■	■	■	■	■	■	■	■		■	■	■
	CCC	■	■	■	■	■	■	■	■	■	■	■	■	■	■	■		■	■	■
Marks																				
	CE	■	■	■	■	■	■	■	■	■	■	■	■	■	■	■		■	■	■
	C-Tick	■	■	■	■	■	■	■	■	■	■	■	■	■	■	■		■	■	■

Notes



CT-D Range

CT-D Range Electronic timers



CT-D Range Benefits and advantages

Characteristics

- Diversity:
 - 2 multifunction timers
 - 10 single-function timers
- Control supply voltages:
 - Wide range: 12-240 V AC/DC
 - Multi range: 24-48 V DC, 24-240 V AC
- 7 time ranges from 0.05s to 100 h or 4 time ranges from 0.05 s - 10 min
- Width of only 17.5 mm
- Light-grey housing in RAL 7035
- Devices with:
 - 1 c/o contact (250 V / 6 A) or 2 c/o contacts (250 V / 5 A)
 - Control input: voltage-related triggering, polarized, capable of switching a parallel load
- Approvals / Marks (partly depending)



6

Benefits

Direct reading scales ①

Direct setting of the time delay without any additional calculation provides accurate time delay adjustment.

LEDs for status indication ②

All actual operational states are displayed by front-face LEDs, thus simplifying commissioning and troubleshooting.

Switching currents

The CT-D range timers allow an output load of up to 6 A on devices with 1 c/o contact and up to 5 A on devices with 2 c/o contacts.

Connection terminals ③

Wide terminal spacing allows connection of wires: 2 x 1.5 mm² (2 x 16 AWG) with wire end ferrules or - 2 x 2.5 mm² (2 x 14 AWG) without ferrules.

Width 17,5 mm ④

With their width of 17.5 mm only, the CT-D range timers are ideally suited for installation in distribution panels.

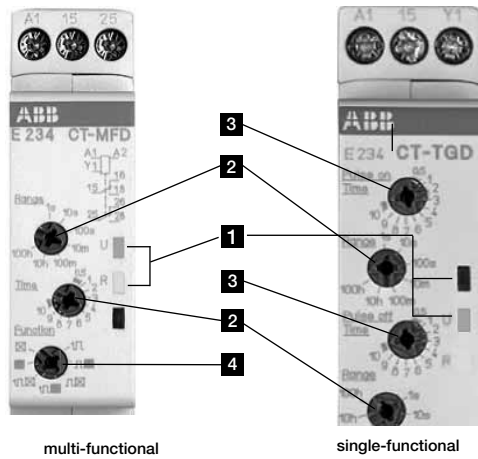

Operating controls

1 LEDs for status indication

U - green LED:

— control supply voltage applied

▭ timing

R, R1, R2 - yellow LED:

▭ output relay energized

2 Time range adjustment

3 Fine adjustment of the time delay

4 Timing range selector

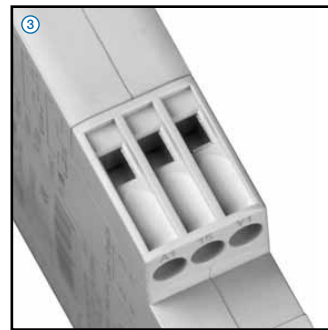
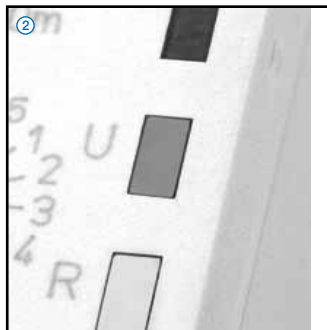
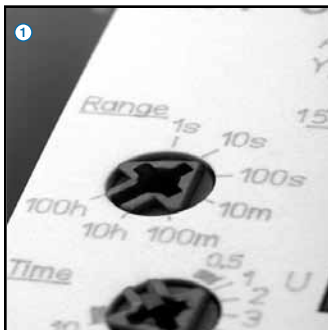

CT-D Range Ordering details

Description

The CT-D range with a width of only 17.5 mm fits into all domestic installation and distribution panels.

For maximum flexibility in operation, 10 single-function as well as 2 multifunction devices with 7 timing functions are available. The devices offer 4 or 7 time ranges from 0.05 seconds up to 100 hours. Their wide input range allows the use in applications worldwide.



CT-MFD.12



CT-ERD.22

- ON-delay
- OFF-delay
- Impulse-ON
- Impulse-OFF
- Flasher starting with ON
- Flasher starting with OFF
- Pulse former
- Pulse generator
- Star-delta change-over

Ordering details

Time function	Rated control supply voltage	Time ranges	Control input	Output	Reference code	Catalog number	Weight (1 pce) kg (lb)		
 	24-240 V AC 24-48 V DC	7 (0.05 s - 100 h)	■	1 c/o	CT-MFD.12	1SVR500020R0000	0.060 (0.132)		
 	12-240 V AC/ DC	7 (0.05 s - 100 h)	■	2 c/o	CT-MFD.21	1SVR500020R1100	0.065 (0.143)		
	24-240 V AC 24-48 V DC	7 (0.05 s - 100 h)		1 c/o	CT-ERD.12	1SVR500100R0000	0.060 (0.132)		
				2 c/o	CT-ERD.22	1SVR500100R0100	0.065 (0.143)		
			■	1 c/o	CT-AHD.12	1SVR500110R0000	0.060 (0.132)		
			■	2 c/o	CT-AHD.22	1SVR500110R0100	0.065 (0.143)		
				1 c/o	CT-VWD.12	1SVR500130R0000	0.060 (0.132)		
				1 c/o	CT-EBD.12	1SVR500150R0000			
				2 x 7 (0.05 s - 100 h)	■	1 c/o	CT-TGD.12 ¹⁾	1SVR500160R0000	0.060 (0.132)
					■	1 c/o	CT-TGD.22 ¹⁾	1SVR500160R0100	0.065 (0.143)
		4 (0.05 s - 10 min)		2 n/o	CT-SDD.22 ²⁾	1SVR500211R0100	0.065 (0.143)		
				2 n/o	CT-SAD.22 ³⁾	1SVR500210R0100	0.065 (0.143)		

1) ON and OFF times adjustable independently: 2 x 7 time ranges 0.05 s - 100 h
 2) Transition time 50 ms fixed
 3) Transition time adjustable

Synonyms

used expression	alternative expression(s)	used expression	alternative expression(s)
1 c/o contact	SPDT	voltage-related	wet / non-floating
2 c/o contacts	DPDT	volt-free	dry / floating

CT-D range Function diagrams

Remarks

Legend

- Control supply voltage not applied / Output contact open
- Control supply voltage applied / Output contact closed
- A1-Y1/B1 Control input with voltage-related triggering

Terminal designations on the device and in the diagrams

- The 1st c/o contact is always designated **15-16/18**.
- The 2nd c/o contact is designated **25-26/28**.
- The n/o contacts of the star-delta timers are designated with **17-18** and **17-28**.
- Control supply voltage is always applied to terminals **A1-A2**.

Function of the yellow LED

The yellow LED **R** glows as soon as the output relay energizes and turns off when the output relay de-energizes.

6

ON-delay (Delay on make) CT-ERD, CT-MFD

This function requires continuous control supply voltage for timing. Timing begins when control supply voltage is applied. The green LED flashes during timing. When the selected time delay is complete, the output relay energizes and the flashing green LED turns steady. If control supply voltage is interrupted, the output relay de-energizes and the time delay is reset. Control input **A1-Y1/B1** of the CT-MFD is disabled when this function is selected.

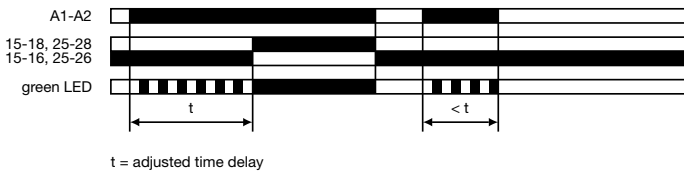

OFF-delay with auxiliary voltage (Delay on break) CT-AHD, CT-MFD

This function requires continuous control supply voltage for timing. If control input A1-Y1/B1 is closed, the output relay energizes immediately. If control input A1-Y1/B1 is opened, the time delay starts. The green LED flashes during timing. When the selected time delay is complete, the output relay de-energizes and the flashing green LED turns steady. If control input **A1-Y1/B1** recloses before the time delay is complete, the time delay is reset and the output relay does not change state. Timing starts again when control input **A1-Y1/B1** re-opens. If control supply voltage is interrupted, the output relay de-energizes and the time delay is reset.

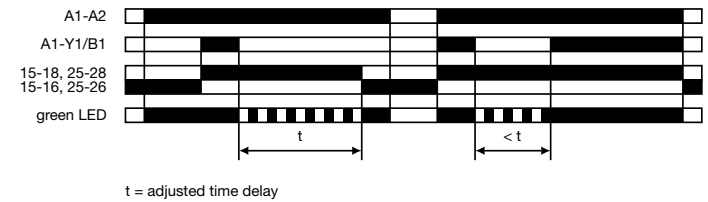

Impulse-ON (Interval) CT-VWD, CT-MFD

This function requires continuous control supply voltage for timing. The output relay energizes immediately when control supply voltage is applied and de-energizes after the set pulse time is complete. The green LED flashes during timing. When the selected pulse time is complete, the flashing green LED turns steady. If control supply voltage is interrupted, the output relay de-energizes and the time delay is reset. Control input A1-Y1/B1 of the CT-MFD is disabled when this function is selected.

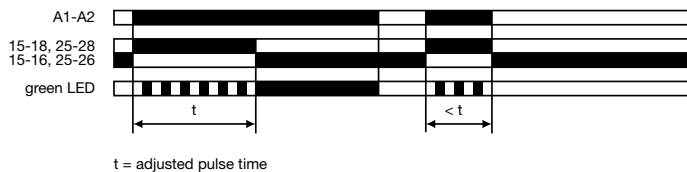

Impulse-OFF with auxiliary voltage (Trailing edge interval) CT-MFD

This function requires continuous control supply voltage for timing. If control supply voltage is applied, opening control input A1-Y1/B1 energizes the output relay immediately and starts timing. The green LED flashes during timing. When the selected pulse time is complete, the output relay de-energizes and the flashing green LED turns steady. Closing control input A1-Y1/B1, before the time delay is complete, de-energizes the output relay and resets the time delay. If control supply voltage is interrupted, the output relay de-energizes and the time delay is reset.

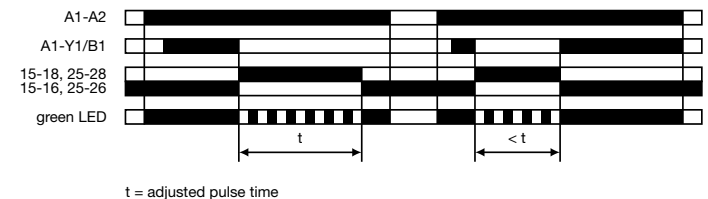

CT-D range Function diagrams

 **Flasher, starting with the ON time
(Recycling equal times, ON first)**
CT-EBD, CT-MFD

Applying control supply voltage starts timing with symmetrical ON & OFF times. The cycle starts with an ON time first. The ON & OFF times are displayed by the flashing green LED, which flashes twice as fast during the OFF time. If control supply voltage is interrupted, the output relay de-energizes and the time delay is reset. Control input **A1-Y1/B1** of the CT-MFD is disabled when this function is selected.

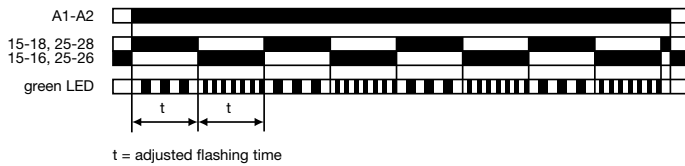

 **Flasher, starting with the OFF time
(Recycling equal times, OFF first)**
CT-MFD

Applying control supply voltage starts timing with symmetrical ON & OFF times. The cycle starts with an OFF time first. The ON & OFF times are displayed by the flashing green LED, which flashes twice as fast during the OFF time. If control supply voltage is interrupted, the output relay de-energizes and the time delay is reset. Control input **A1-Y1/B1** of the CT-MFD is disabled when this function is selected.

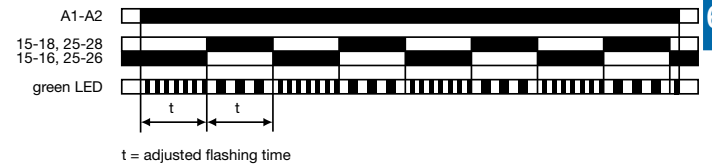

6

 **Pulse former (Single shot)**
CT-MFD

This function requires continuous control supply voltage for timing. Closing control input **A1-Y1/B1** energizes the output relay immediately and starts timing. Operating the control contact switch **A1-Y1/B1** during the time delay has no effect. The green LED flashes during timing. When the selected ON time is complete, the output relay de-energizes and the flashing green LED turns steady. After the ON time is complete, it can be restarted by closing control input **A1-Y1/B1**. If control supply voltage is interrupted, the output relay de-energizes and the time delay is reset.

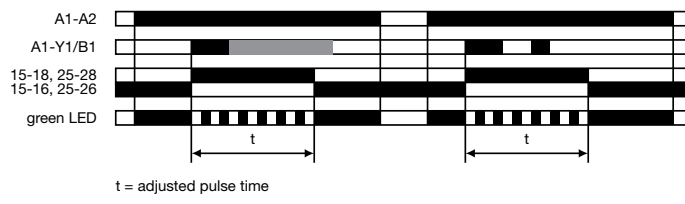

 **Pulse generator, starting with the ON or OFF time
(Recycling unequal times, ON or OFF first)**
CT-TGD

This function requires continuous control supply voltage for timing. Applying control supply voltage, with open control input **A1-Y1/B1**, starts timing with an ON time first. Applying control supply voltage, with closed control input **A1-Y1/B1**, starts timing with an OFF time first. The ON & OFF times are displayed by the flashing green LED, which flashes twice as fast during the OFF time. The ON & OFF times are independently adjustable. If control supply voltage is interrupted, the output relay de-energizes and the time delay is reset.

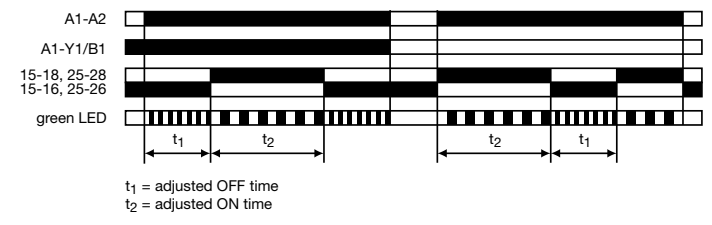

CT-D range Function diagrams

△ **Star-delta change-over
(Star-delta starting)
CT-SDD, CT-SAD**

This function requires continuous control supply voltage for timing. Applying control supply voltage to terminals **A1-A2**, energizes the star contactor connected to terminals **17-18** and begins the set starting time t_1 . The green LED flashes during timing. When the starting time is complete, the first output contact de-energizes the star contactor.

Now, the transition time t_2 starts. When the transition time is complete, the second output contact energizes the delta contactor connected to terminals **17-28**. The delta contactor remains energized as long as control supply voltage is applied to the unit.

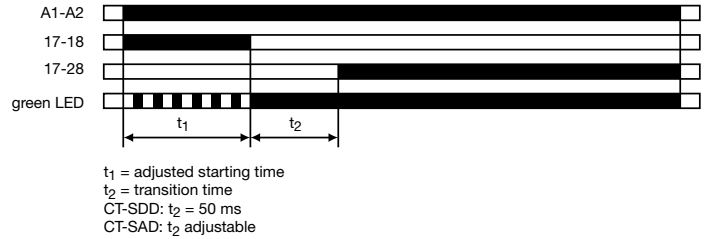

6

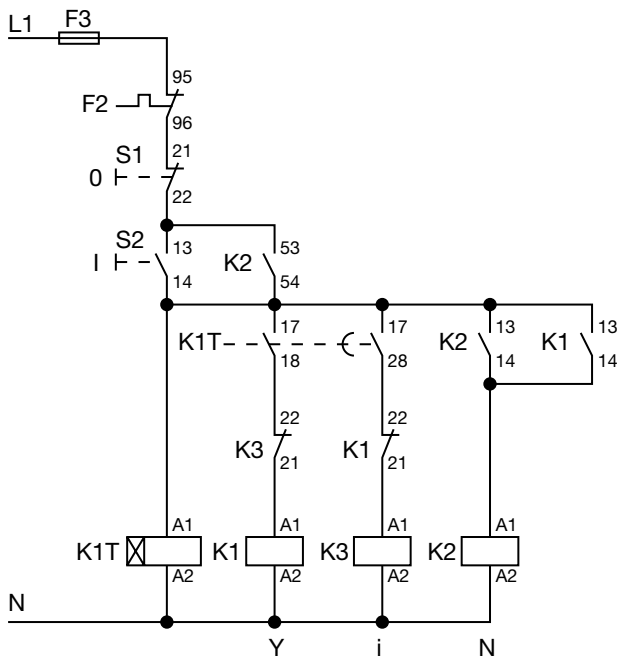

Control circuit diagram

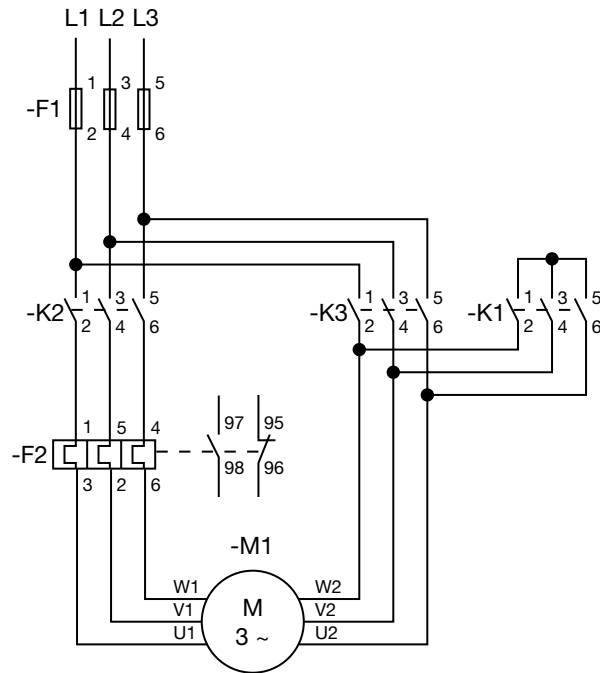

Power circuit diagram

CT-D range Connection diagrams

CT-MFD.21

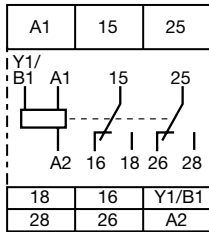

A1-A2 Supply: 12-240 V AC/DC

15-16/18 1. c/o contact
25-26/28 2. c/o contact
A1-Y1/B1 Control input

CT-MFD.12

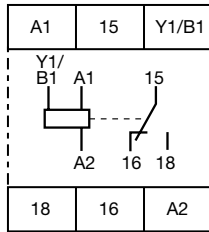

A1-A2 Supply: 24-48 V DC or 24-240 V AC

15-16/18 1. c/o contact
A1-Y1/B1 Control input

CT-ERD.22

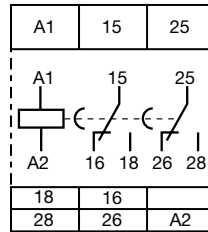

A1-A2 Supply: 24-48 V DC or 24-240 V AC

15-16/18 1. c/o contact
25-26/28 2. c/o contact

CT-ERD.12

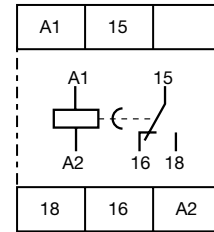

A1-A2 Supply: 24-48 V DC or 24-240 V AC

15-16/18 1. c/o contact

CT-AHD.22

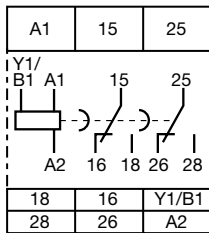

A1-A2 Supply: 24-48 V DC or 24-240 V AC

15-16/18 1. c/o contact
25-26/28 2. c/o contact
A1-Y1/B1 Control input

CT-AHD.12

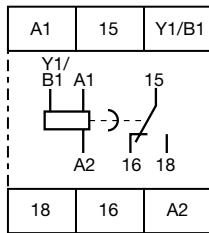

A1-A2 Supply: 24-48 V DC or 24-240 V AC

15-16/18 1. c/o contact
A1-Y1/B1 Control input

CT-VWD.12

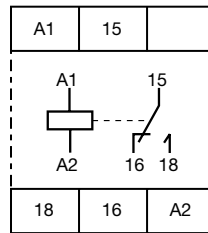

A1-A2 Supply: 24-48 V DC or 24-240 V AC

15-16/18 1. c/o contact

CT-EBD.12

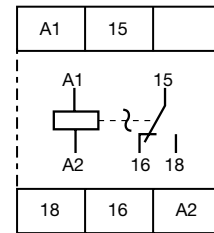

A1-A2 Supply: 24-48 V DC or 24-240 V AC

15-16/18 1. c/o contact

CT-TGD.22

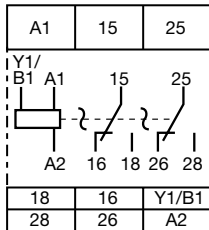

A1-A2 Supply: 24-48 V DC or 24-240 V AC

15-16/18 1. c/o contact
25-26/28 2. c/o contact
A1-Y1/B1 Control input

CT-TGD.12

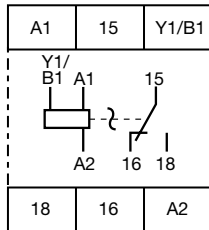

A1-A2 Supply: 24-48 V DC or 24-240 V AC

15-16/18 1. c/o contact
A1-Y1/B1 Control input

CT-SDD.22

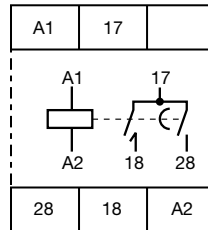

A1-A2 Supply: 24-48 V DC or 24-240 V AC

17-18 1. n/o contact (star contactor)
17-28 2. n/o contact (delta contactor)

CT-SAD.22

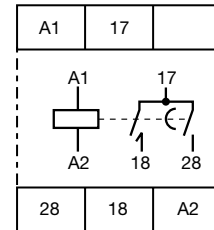



A1-A2 Supply: 24-48 V DC or 24-240 V AC

17-18 1. n/o contact (star contactor)
17-28 2. n/o contact (delta contactor)

CT-D range

Technical data

Data at $T_a = 25\text{ °C}$ and rated values, unless otherwise indicated

		CT-D with 1 c/o contact	CT-D with 2 c/o contacts	CT-MFD.21
Input circuit - Supply circuit				
Rated control supply voltage U_S		24-240 V AC / 24-48 V DC		12-240 V AC/DC
Rated control supply voltage U_S tolerance				-15...+10 %
Rated frequency		AC/DC versions	DC or 50/60 Hz	50/60 Hz
Frequency range		AC versions	DC or 47-63 Hz	see data sheet
Typical current / power consumption				
Power failure buffering time		min. 20 ms	min. 30 ms	
6 Input circuit - Control circuit				
Kind of triggering		voltage-related triggering		
Control input, Control function		A1-Y1/B1	start timing external	
Parallel load / polarized		yes / yes		
Rated operational voltage U_b		250 V		
Minimum switching voltage / minimum switching current		12 V / 100 mA		
Maximum switching voltage / maximum switching current		see load limit curves		
Minimum control pulse length		30 ms		
Control voltage potential		see rated control supply voltage		
Current consumption of the control input		max. 4 mA	see data sheet	
Timing circuit				
Time ranges		7 time ranges 0.05 s - 100 h 1.) 0.05-1 s 2.) 0.5-10 s 3.) 5-100 s 4.) 0.5-10 min 5.) 5-100 min 6.) 0.5-10 h 7.) 5-100 h		
		4 time ranges 0.05 s - 10 min (CT-SDD, CT-SAD) 1.) 0.05-1 s 2.) 0.5-10 s 3.) 5-100 s 4.) 0.5-10 min		
Recovery time		< 50 ms		
Accuracy within the rated control supply voltage tolerance		$\Delta t < 0.005\% / V$		
Accuracy within the temperature range		$\Delta t < 0.06\% / \text{°C}$		
Repeat accuracy (constant parameters)		$\Delta t \pm 0.5\%$		
Star-delta transition time		CT-SDD / CT-SAD	fixed 50 ms / adjustable: 20-100 ms in steps of 10 ms	
Star-delta transition time tolerance		CT-SDD / CT-SAD	$\pm 3\text{ ms}$	
Indication of operational states				
Control supply voltage / timing		U: green LED	 : control supply voltage applied  : timing	
Relay status		R: yellow LED	 : output relay energized	
Output circuit				
Kind of output		15-16/18 15-16/18; 25-26/28 17-18; 17-28	Relay, 1 c/o contact -	- Relay, 2 c/o contacts relay, 2 n/o contacts (CT-SDD, CT-SAD)
Contact material		Cd-free, see data sheet		
Rated operational voltage U_b		IEC/EN 60947-1 250 V		
Minimum switching voltage / minimum switching current		12 V / 100 mA		
Maximum switching voltage / maximum switching current		see load limit curves		
Rated operational current I_b (IEC/EN 60947-5-1)		AC12 (resistive) at 230 V AC15 (inductive) at 230 V AC15 (inductive) at 230 V DC13 (inductive) at 24 V	6 A 3 A 6 A 2 A	5 A 3 A 5 A 2 A ¹⁾
		0.75 A (AC15 n/c contact)		
		1 A		
AC rating (UL 508)		Utilization category (Rating Code)	B 300	
		max. rated operational voltage	300 V AC	
		Maximum continuous thermal current at B300	5 A	
		max. making/breaking apparent power at B300	3600 VA / 360 VA	
Mechanical lifetime		30 x 10 ⁶ switching cycles		
Electrical lifetime		0.1 x 10 ⁶ switching cycles		
Max. fuse rating to achieve short-circuit protection (IEC/EN 60947-5-1)		n/c contact n/o contact	6 A fast-acting 10 A fast-acting	

CT-D range

Technical data

	CT-D with 1 c/o contact	CT-D with 2 c/o contacts	CT-MFD.21
General data			
Duty time		100%	
Dimensions (W x H x D)	17.5 x 70 x 58 mm (0.69 x 2.76 x 2.28 in)	17.5 x 80 x 58 mm (0.69 x 3.15 x 2.28 in)	
Weight		see ordering details	
Mounting		DIN rail (IEC/EN 60715), snap-mounting without any tool	
Mounting position		any	
Minimum distance to other units	horizontal / vertical	no / no	
Degree of protection	housing / terminals	IP50 / IP20	
Electrical connection			
Wire size	fine-strand with(out) wire end ferrule	2 x 0.5-1.5 mm ² (2 x 20-16 AWG) 1 x 0.5-2.5 mm ² (1 x 20-14 AWG)	
	rigid	2 x 0.5-1.5 mm ² (2 x 20-16 AWG) 1 x 0.5-4 mm ² (1 x 20-12 AWG)	
Stripping length		7 mm (0.28 in)	
Tightening torque		0.5-0.8 Nm	
Environmental data			
Ambient temperature range	operation / storage	-20 ... +60 °C / -40 ... +85 °C	
Damp heat (cyclic)	IEC/EN 60068-2-30	6 x 24 h cycles, 55 °C, 95 % RH	
Vibration (sinusoidal)	IEC/EN 60068-2-6	40 m/s ² , 20 cycles, 10...150...10 Hz	
Shock (half-sine)	IEC/EN 60068-2-27	100 m/s ² , 11 ms	
Isolation data			
Rated impulse withstand voltage U _{imp} between all isolated circuits	VDE 0110, IEC/EN 60664-1	4 kV; 1.2/50 µs	
Pollution category	IEC/EN 60664-1, VDE 0110	3	
Overvoltage category	IEC/EN 60664-1, VDE 0110	III	
Rated insulation voltage U _i	input circuit / output circuit output circuit 1 / output circuit 2	300 V 300 V	
Basic insulation (IEC/EN 61140)	input circuit / output circuit	300 V	
Protective separation (VDE 0106 part 101 and part 101/A1; IEC/EN 61140)	input circuit / output circuit	250 V	
Power-frequency withstand voltage test (test voltage, routine test)	between all isolated circuits	2.5 kV, 50 Hz, 1 s	
Standards			
Product standard		IEC 61812-1, EN 61812-1 + A11, DIN VDE 0435 part 2021	
Low Voltage Directive		2006/95/EC	
EMC Directive		2004/108/EC	
RoHS Directive		2002/95/EC	
Electromagnetic compatibility			
Interference immunity to		IEC/EN 61000-6-1, IEC/EN 61000-6-2	
electronic discharge	IEC/EN 61000-4-2	Level 3 (6 kV / 8 kV)	
radiated, radio-frequency, electromagnetic field	IEC/EN 61000-4-3	Level 3 (10 V / m)	
electrical fast transient/burst	IEC/EN 61000-4-4	Level 3 (2 kV / 5 kHz)	
surge	IEC/EN 61000-4-5	Level 4	
conducted disturbances, induced by radio-frequency fields	IEC/EN 61000-4-6	Level 3 (10 V)	
Interference emissions		IEC/EN 61000-6-3, IEC/EN 61000-6-4	
high-frequency radiated	IEC/CISPR 22, EN 55022	Class B	
high-frequency conducted	IEC/CISPR 22, EN 55022	Class	

CT-D range

Technical data, Technical diagrams

Technical diagrams

Load limit curves

AC load (resistive)

6

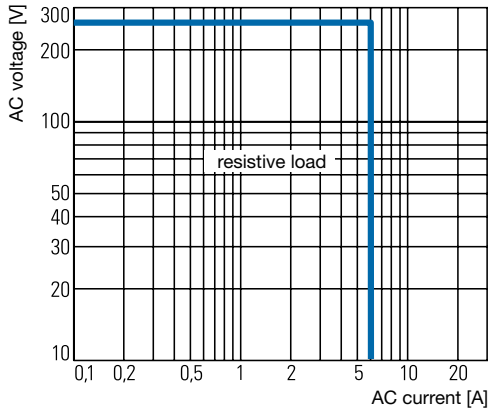

CT-D.1x

DC load (resistive)

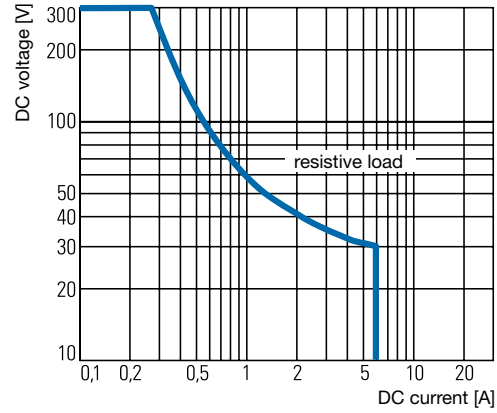

CT-D.1x

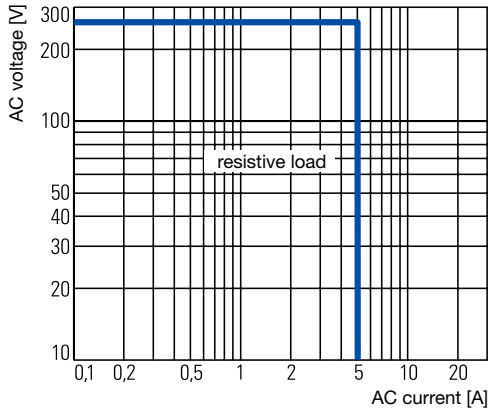

CT-D.2x

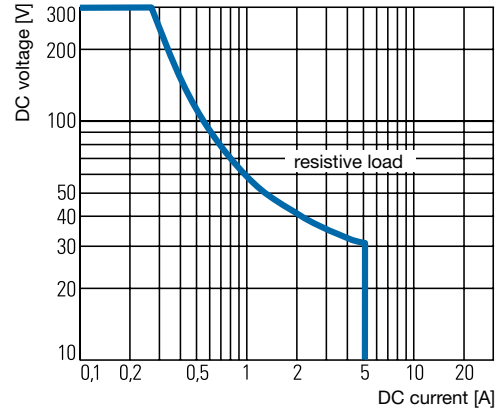

CT-D.2x

Derating factor F for inductive AC load

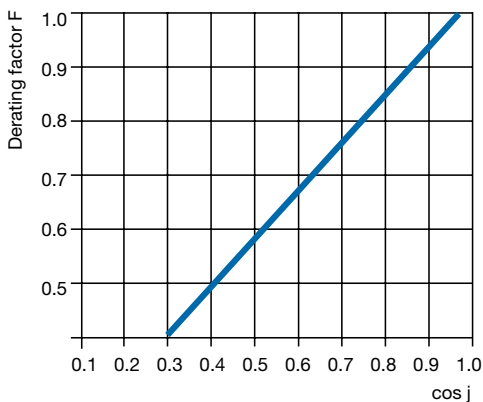

Contact lifetime

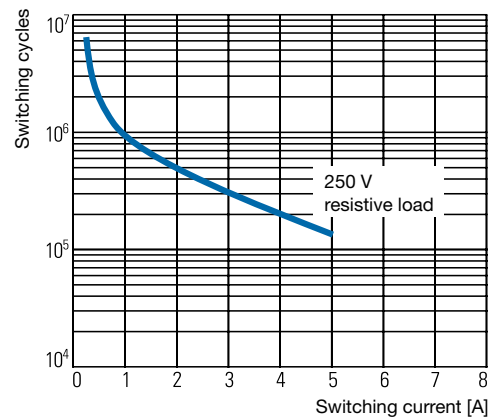

CT-D range

Approximate dimensions

Wiring notes for devices with control input

A parallel load to the control input is possible

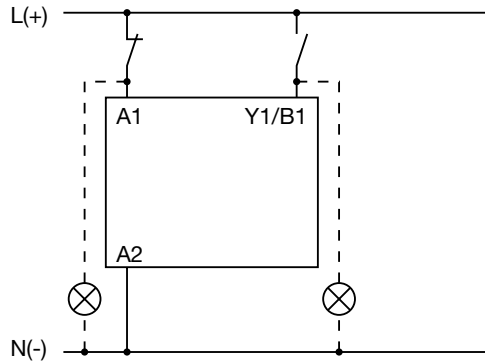

Dimensional drawings

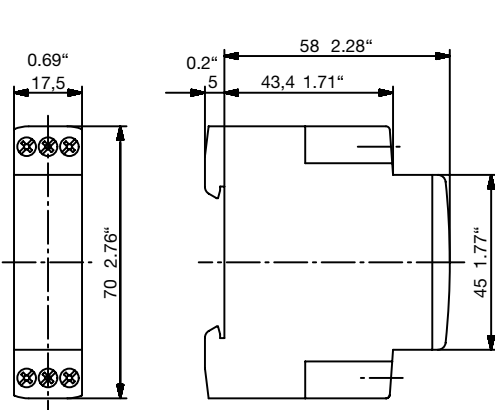

CT-D devices with 1 c/o contact or 2 n/o contacts

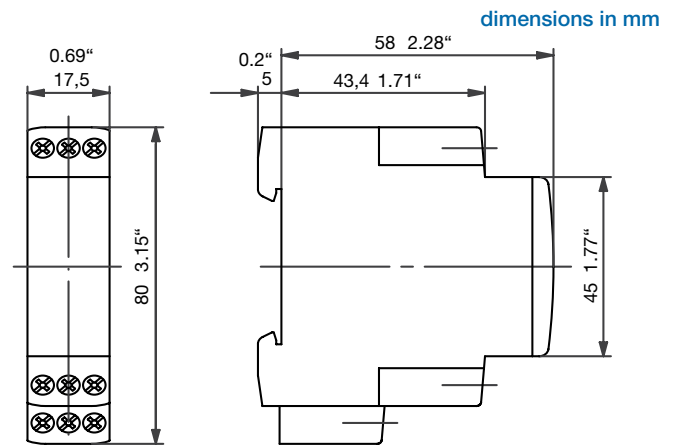

CT-D devices with 2 c/o contacts

dimensions in mm

Notes

CT-E Range Electronic Timers



CT-E range

Benefits and advantages

Characteristics

- Diversity:
 - 2 multifunction timers
 - 56 single-function timers
 - 4 switching relays
- Control supply voltages:
 - Dual range: 24 V AC/DC
 - Single range: 110-130 V AC, 220-240 V AC
 - Wide range: 24-240 V AC/DC (CT-MFE)
- Time ranges
 - 5 single ranges: 0.05-1 s, 0.1-10 s, 0.3-30 s, 3-300 s, 0.3-30 min
 - 8 time ranges: 0.05 s - 100 h (CT-MFE)
- Devices with 1 c/o (SPDT) contact (250 V / 4 A) or solid-state output for high switching frequencies (thyristor 0.8 A)
- Switching relay CT-IRE for added switching contacts with either side-by-side or diagonally positioned connection terminals

6

Benefits

Direct reading scales ①

Direct setting of the time delay without any additional calculation provides accurate time delay adjustment.

LEDs for status indication ②

All actual operational states are displayed by front-face LEDs, thus simplifying commissioning and troubleshooting.

Connection screws in M3 (Poqidrive 1) ③

Easy and fast tightening and release of the connection screws with poqidrive, pan- or crosshead screwdriver.

Solid-state output ④

Devices with solid-state output are the perfect solution for high operation cycles.

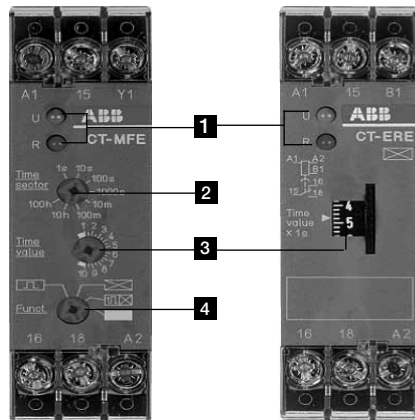

Operating controls

1 LEDs for status indication

U - green LED: control supply voltage applied

R2: red LED: output relay energized

2 Time range adjustment (only multifunctional devices)

3 Fine adjustment of the time delay

4 Preselection of the timing function (only multifunctional devices)

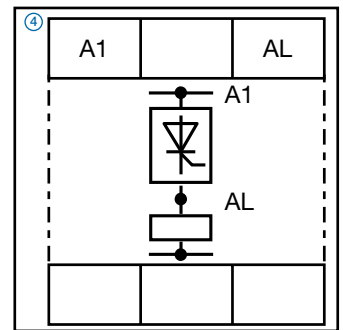
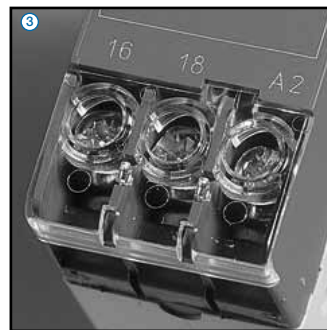
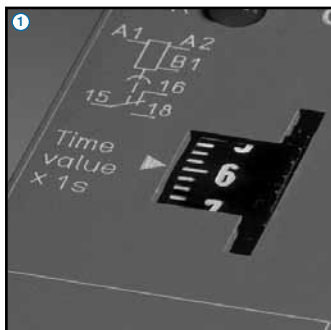

CT-E range

Ordering details



Description

The CT-E range with its excellent price/performance ratio offers an ideal solution for serial applications. 56 single function devices with 5 different time ranges as well as 2 multifunction timers with 6 functions and 8 time ranges offer the highest possible flexibility for almost every application. For high operating cycles, contact-free CT-E timers with solid-state output are available.

Ordering details

Time function	Rated control supply voltage	Time ranges	Control Input	Output	Reference code	Catalog number	Weight (1 pce) kg (lb)
	24-240 V AC/DC	8 (0.05 s - 100 h)	■	1 c/o	CT-MFE	1SVR550029R8100	0.08 (0.18)
	24 V AC/DC, 220-240 V AC	0.1-10 s	■	1 c/o	CT-ERE	1SVR550107R1100	0.08 (0.18)
		0.3-30 s				1SVR550107R4100	
		3-300 s				1SVR550107R2100	
	0.3-30 min	1SVR550107R5100					
	110-130 V AC	0.1-10 s				1SVR550100R1100	
		0.3-30 s				1SVR550100R4100	
3-300 s		1SVR550100R2100					
	24 V AC/DC	0.1-10 s	■	1 c/o	CT-AHE ²⁾	1SVR550118R1100	0.08 (0.18)
		0.3-30 s				1SVR550118R4100	
		3-300 s				1SVR550118R2100	
	110-130 V AC	0.1-10 s				1SVR550110R1100	
		0.3-30 s				1SVR550110R4100	
		3-300 s				1SVR550110R2100	
220-240 V AC	0.1-10 s	1SVR550111R1100					
	0.3-30 s	1SVR550111R4100					
	3-300 s	1SVR550111R2100					
	24 V AC/DC, 220-240 V AC	0.1-10 s	■	1 c/o	CT-ARE	1SVR550127R1100	0.08 (0.18)
		0.3-30 s				1SVR550127R4100	
	110-130 V AC	0.1-10 s				1SVR550120R1100	
		0.3-30 s				1SVR550120R4100	
	24 V AC/DC, 220-240 V AC	0.1-10 s	■	1 c/o	CT-VWE	1SVR550137R1100	0.08 (0.18)
		0.3-30 s				1SVR550137R4100	
		3-300 s				1SVR550137R2100	
	110-130 V AC	0.1-10 s				1SVR550130R1100	
		0.3-30 s				1SVR550130R4100	
		3-300 s				1SVR550130R2100	
	24 V AC/DC	0.05-1 s	■	1 c/o	CT-AWE	1SVR55015 R3100	0.08 (0.18)
	110-130 V AC					1SVR550150 R3100	
	220-240 V AC					1SVR550151R3100	

- ON-delay
- OFF-delay
- Impulse-ON
- Impulse-OFF
- Flasher starting with ON
- Flasher starting with OFF
- Pulse former

¹⁾ without auxiliary voltage, True Off-delay timer
²⁾ with control input

Synonyms

used expression	alternative expression(s)	used expression	alternative expression(s)
1 c/o contact	SPDT	voltage-related	wet / non-floating
2 c/o contacts	DPDT	volt-free	dry / floating

CT-E range Ordering details

Ordering details

Time function	Rated control supply voltage	Time ranges	Control Input	Output	Reference code	Catalog number	Weight (1 pce) kg (lb)		
1□■	24 V AC/DC	0.1-10 s 0.3-30 s 3-300 s	■	1 c/o	CT-AWE ²⁾	1SVR550148R1100	0.08 (0.18)		
	110-130 V AC	1SVR550148R4100							
		1SVR550148R2100							
		1SVR550140R1100							
	220-240 V AC	1SVR550140R4100							
		1SVR550140R2100							
		1SVR550141R1100							
		1SVR550141R4100							
		1SVR550141R2100							
□■	24 V AC/DC, 220-240 V AC	0.1-10 s		1 c/o	CT-EBE ⁷⁾	1SVR550167R1100	0.08 (0.18)		
	110-130 V AC					1SVR550160R1100			
△□	24 V AC/DC, 220-240 V AC	0.1-10 s		1 c/o	CT-YDE ¹⁾	1SVR550207R1100	0.08 (0.18)		
		0.3-30 s				1SVR550207R4100			
		3-300 s				1SVR550207R2100			
	110-130 V AC	0.1-10 s				1SVR550200R1100			
		0.3-30 s				1SVR550200R4100			
		3-300 s				1SVR550200R2100			
△1□	24 V AC/DC, 220-240 V AC	0.3-30 s		1 n/o + 1 n/c	CT-SDE ^{3) 8)}	1SVR550217R4100	0.08 (0.18)		
	110-130 V AC					1SVR550210R4100			
	380-415 V AC					1SVR550212R4100			
1□□ □□ □■	24-240 V AC/DC	0.1-10 s, 3-300 s		solid-state	CT-MKE ^{6) 9)}	1SVR550019R0000	0.08 (0.18)		
						□		CT-EKE	1SVR550509R1000
									1SVR550509R4000
■	24-240 V AC	0.1-10 s 0.3-30 s 3-300 s			CT-AKE	1SVR550509R2000	0.08 (0.18)		
						1SVR550519R1000			
						1SVR550519R4000			
□	24 V AC/DC			1 c/o	CT-IRE ⁴⁾	1SVR550519R2000	0.08 (0.18)		
	220-240 V AC/ DC					1SVR550228R9100			
□	24 V AC/DC			1 c/o	CT-IRE ⁵⁾	1SVR550221R9100	0.08 (0.18)		
	220-240 V AC/DC					1SVR550238R9100			
□	24 V AC/DC			1 c/o	CT-IRE ⁵⁾	1SVR550231R9100	0.08 (0.18)		
	220-240 V AC/DC					1SVR550231R9100			

- ON-delay
- OFF-delay
- 1□□ Impulse-ON
- 1□■ Impulse-OFF
- Flasher starting with ON
- Flasher starting with OFF
- Pulse former
- Switching relay
- △□ Star-delta change-over twice ON-delayed
- △1□ Star-delta change-over with impulse
- Pulse generator starting with ON or OFF

- 1) without auxiliary voltage
- 2) with control input
- 3) with fixed transition time
- 4) A1/A2 diagonally
- 5) A1/A2 on top
- 6) solid-state output, functions and time range selection via external jumpers
- 7) symmetric ON & OFF times
- 8) common contact
- 9) Functions: ON-delay (AC/DC), Impuls-ON (AC only), Flasher starting with OFF (AC only)

Notice

CT...KE are solid-state timers with thyristor output for 2-wire applications. They are connected directly in series with the control coil of contactors or relays. Voltage should not be applied without a load connected, because there is no current limiting in the unit.

CT-E range Function diagrams

Remarks

Legend

- Control supply voltage not applied / Output contact open
- Control supply voltage applied / Output contact closed
- A1-Y1/B1 Control input with voltage-related triggering

Terminal designations on the device and in the diagrams

- The c/o contact is always designated **15-16/18**.
- The n/o contacts are designated with **15-16** and **15-18**.
- Control supply voltage is always applied to terminals **A1-A2/B1**.

Function of the red LED

The red LED **R** glows as soon as the output relay energizes and turns off when the output relay de-energizes.

☒ ON-delay (Delay on make) CT-ERE, CT-MFE

Timing begins when control supply voltage is applied. When the selected time delay is complete, the output relay energizes.
If control supply voltage is interrupted, the output relay de-energizes and the time delay is reset.
Interrupting control supply voltage before the time delay is complete, resets the time delay. The output relay does not energize.
Control input **A1-Y1** of the CT-MFE is disabled when this function is selected.

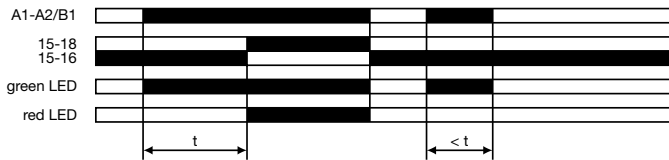

t = adjusted time delay

■ OFF-delay, with auxiliary voltage (Delay on break) CT-AHE, CT-MFE

This function requires continuous control supply voltage for timing.
Timing is controlled by a control input, connected to terminals **A1-Y1**. If the control contact is closed, the output relay energizes. If control input **A1-Y1** is opened, the selected time delay starts. When the time delay is complete, the output relay de-energizes.
If control input **A1-Y1** closes before the time delay is complete, the time delay is reset. Timing starts again when the control input re-opens.

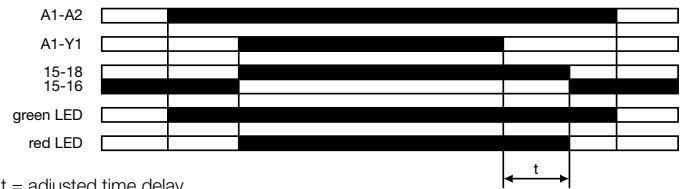

t = adjusted time delay
Minimum control pulse length: 20 ms

CT-E range Function diagrams

OFF-delay, without auxiliary voltage (true delay on break) CT-ARE

The OFF-delay function without auxiliary voltage does not require control supply voltage for timing.
Applying control supply voltage, energizes the output relay. If control supply voltage is interrupted, the OFF-delay starts. When timing is complete, the output relay de-energizes.
If control supply voltage is re-applied, before the time delay is complete, the time delay is reset and the output relay remains energized.
Control supply voltage must be applied for the minimum energizing time (200 ms), for proper operation.

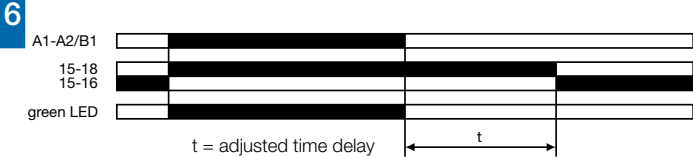

Impulse-ON (Interval) CT-VVE, CT-MFE

The output relay energizes immediately when control supply voltage is applied and de-energizes when the selected time delay is complete.
If control supply voltage is interrupted before the time delay is complete, the output relay de-energizes and the time delay is reset.
The control input **A1-Y1** of the CT-MFE has to be jumpered if this timing function is configured.

CT-VVE:

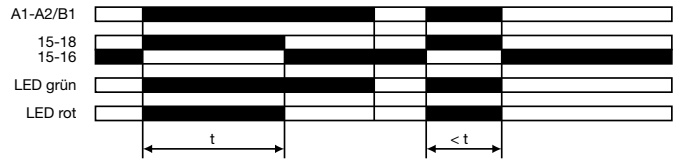

CT-MFE:

t = adjusted pulse time

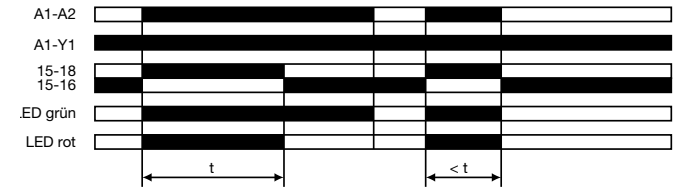

t = adjusted pulse time

Impulse-OFF, without auxiliary voltage (True trailing edge interval) CT-AWE

The Impulse-OFF function without auxiliary voltage does not require control supply voltage for timing.
If control supply voltage is interrupted, the output relay energizes and the OFF time starts. When timing is complete, the output relay de-energizes.
If control supply voltage is re-applied, before the time delay is complete, the time delay is reset and the output relay de-energizes.
Control supply voltage must be applied for the minimum energizing time (200 ms), for proper operation.

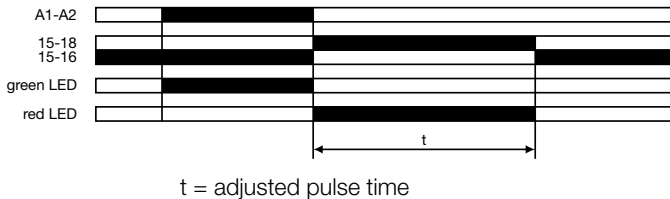

Impulse-OFF, with auxiliary voltage (Trailing edge interval) CT-AWE

This function requires continuous control supply voltage. Opening control input **A1-Y1**, energizes the output relay immediately and timing begins. When the selected time delay is complete, the output relay de-energizes.

Interrupting control supply voltage or closing control input **A1-Y1**, before the time delay is complete, de-energizes the output relay and resets the time delay.

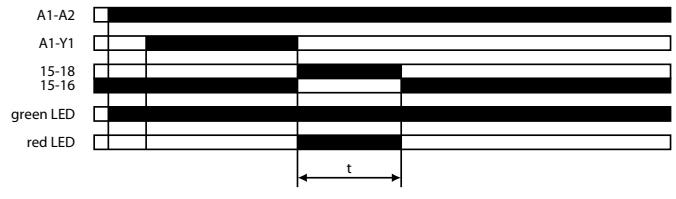

CT-E range Function diagrams

**Flasher starting with ON
(Recycling equal times, ON first) CT-MFE**

Applying control supply voltage, starts timing with symmetrical ON & OFF times. The cycle starts with an ON time first.
If control supply voltage is interrupted, the output relay de-energizes and the time delay is reset.
Control input **A1-Y1** of the CT-MFE has to be open when this function is selected.

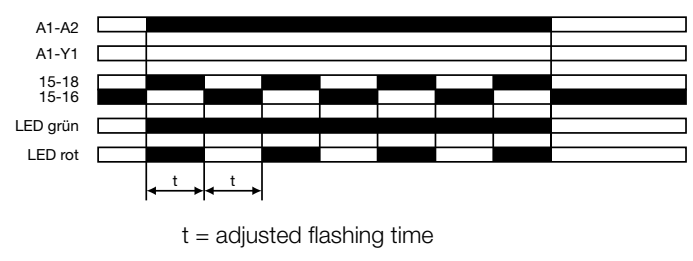

**Flasher starting with OFF
(Recycling equal times, OFF first) CT-EBE, CT-MFE**

Applying control supply voltage, starts timing with symmetrical ON & OFF times. The cycle starts with an OFF time first.
If control supply voltage is interrupted, the output relay de-energizes and the time delay is reset.
Control input **A1-Y1** of the CT-MFE has to be jumpered when this function is selected.

CT-EBE:

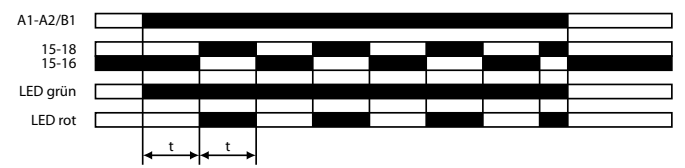

CT-MFE:

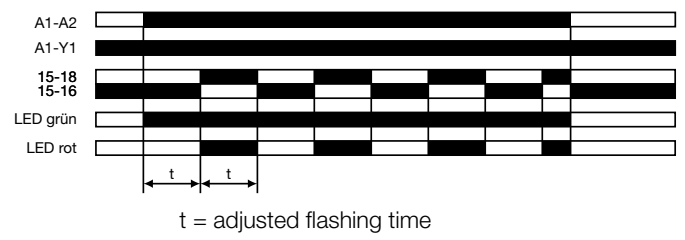

**Pulse former (Single shot)
CT-MFE**

Closing the control input connected to terminals **A1-Y1**, with control supply voltage applied, energizes the output relay for the selected ON time. When the ON time is complete, the output relay de-energizes. Operating the control input switch **A1-Y1** during the time delay has no effect.
After the time delay is complete, it can be restarted by closing control input **A1-Y1**.
If control supply voltage is interrupted during timing, the output relay de-energizes and the ON time is reset.

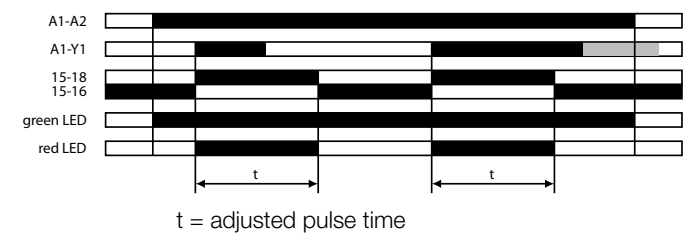

**Switching relay
CT-IRE**

The switching relay may be used to increase the number of available contacts or to reinforce contacts, or as a coupling/decoupling interface.
Applying control supply voltage, energizes the output relay. The output relay de-energizes if supply voltage is interrupted.



CT-E range Function diagrams

⚡ CT Range Star-delta change-over CT-YDE

Applying control supply voltage, energizes the star contactor (K1) and the line contactor (K2) and begins the set starting time.

When the starting time is complete, contact 15-16 de-energizes the star contactor (K1) Now, the fixed transition time starts.

When the transition time is complete, contact 15-16 energizes the delta contactor (K3).

6

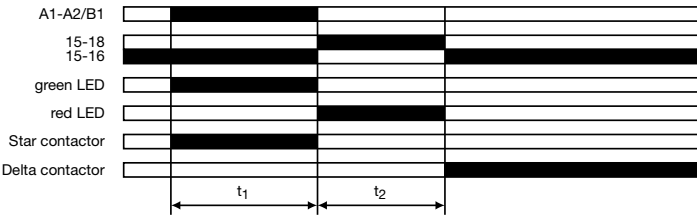

t_1 = adjustable starting time
 t_2 = fixed transition time of 50 ms

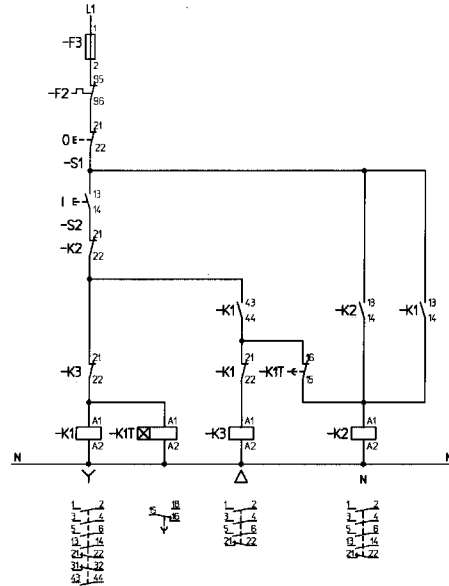

Control circuit diagram

⚡ CT Range Star-delta change-over CT-SDE

Applying control supply voltage, energizes the star contactor (K1) and the line contactor (K2) and begins the set starting time.

When the starting time is complete, contact 15-16 de-energizes the star contactor (K1). Now, the fixed transition time starts.

When the transition time is complete, contact 15-18 energizes the delta contactor (K3).

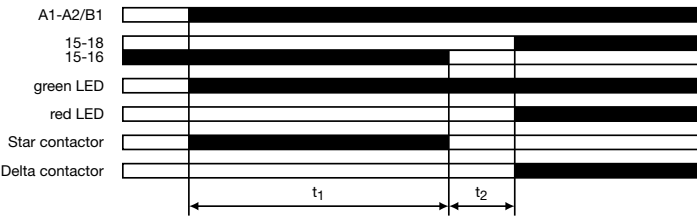

t_1 = adjustable starting time
 t_2 = fixed transition time of 30 ms

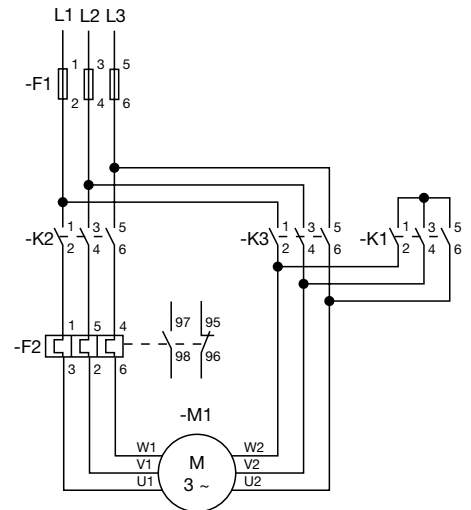

Power circuit diagram

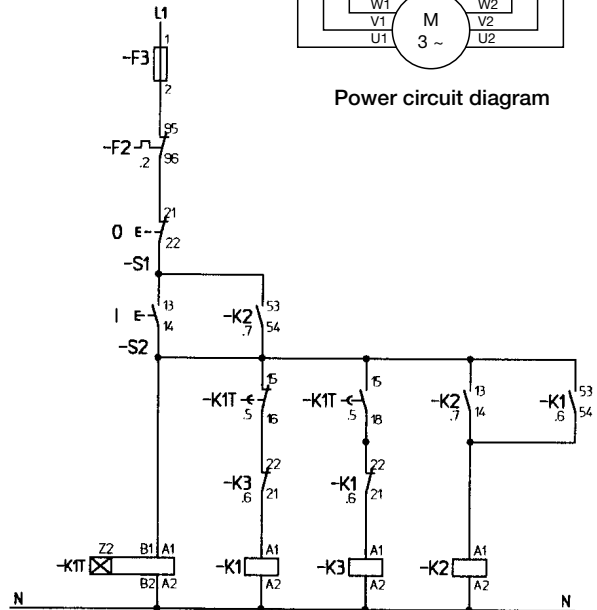

Control circuit diagram

CT-E range Function diagrams

Multifunction timer CT-MKE

Functions and time ranges are programmed by simply plugging in external wire jumpers.

☒ ON-delay (Delay on Make)

Without external connection. Timing begins when control supply voltage is applied to terminal **A1** and the load connected in series with **A2**. When the selected time delay is complete, the load connected to **A1-A2** energizes. If control supply voltage is interrupted, the load de-energizes and the time delay is reset. Interrupting control supply voltage before the time delay is complete, resets the time delay. The load does not energize.

1⏏ Impulse-ON (Interval)

External connection **X1-X4** required. The load energizes and timing starts when control supply voltage is applied to terminal **A1** and the load connected in series with **A2**. When the selected time delay is complete, the load de-energizes. Interrupting control supply voltage before the time delay is complete, de-energizes the load and resets the time delay.

⏏ Flasher, starting with ON

External connection **X1-X4** and **X2-X4** required. When control supply voltage is applied to terminal **A1** and the load connected in series with **A2**, the load energizes and de-energizes with the selected ON & OFF times. The ON & OFF times are equal. The cycle starts with an ON time first (load energized). If control supply voltage is interrupted, the load de-energizes and the time delay is reset.

⏏ Flasher, starting with OFF

External connection **X2-X4** required. When control supply voltage is applied to terminal **A1** and the load connected in series with **A2**, the load energizes and de-energizes with the selected ON & OFF times. The ON & OFF times are equal. The cycle starts with an OFF time first (load de-energized). If control supply voltage is interrupted, the load de-energizes and the time delay is reset.

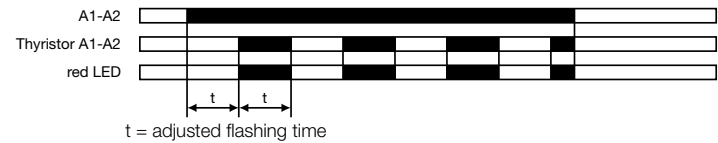
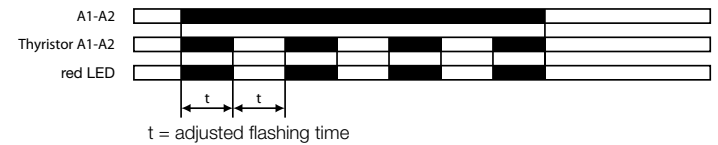
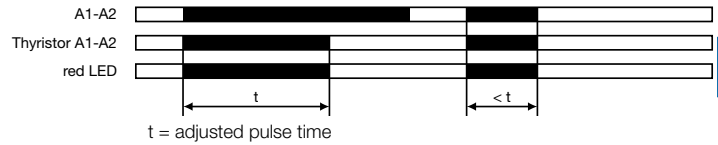
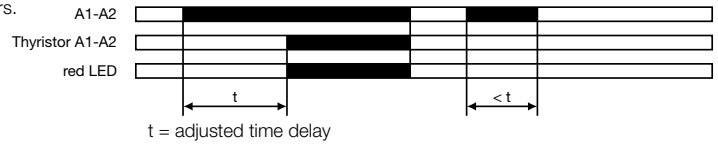

Programming the time ranges

X3-X4 jumpered: 0,1-10 s

X3-X4 open: 3-300 s

☒ ON-delay (Delay on make) CT-EKE

Timing begins when control supply voltage is applied to terminal **A1** and the load connected in series with **AL**. When the selected time delay is complete, the load energizes. The green LED glows as long as the load is energized. If control supply voltage is interrupted, the load de-energizes and the time delay is reset. Interrupting control supply voltage before the time delay is complete, resets the time delay. The load does not energize.

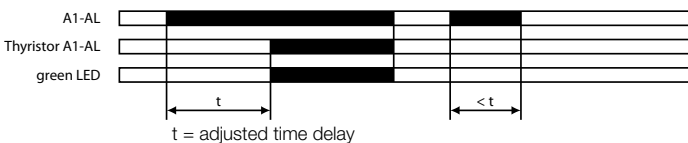

☐ OFF-delay, with auxiliary voltage (Delay on break) CT-AKE

The OFF-delay function with auxiliary voltage requires continuous control supply voltage at terminal **A1** and the load connected in series with **AL**, for timing. Timing is controlled by a control input, connected to terminals **Y2-A2**. When the control input closes, the load energizes. If the control input opens, the selected time delay starts (minimum control pulse length is 20 ms). The green LED glows as long as the load is energized. When the selected time delay is complete, the load de-energizes. If control input **Y2-A2** closes before the time delay is complete, the time delay is reset and the load remains energized. Timing starts again when the control input re-opens. Interrupting control supply voltage resets the time delay and de-energizes the load.

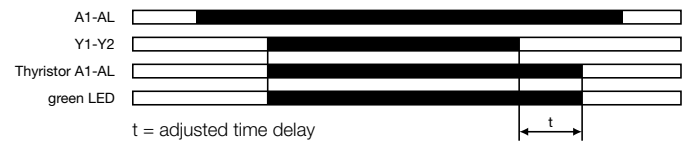

Notice:

CT...KE are solid-state timers with thyristor output for 2-wire applications. They are connected directly in series with the control coil of contactors or relays. Voltage should not be applied without a load connected, because there is no current limiting in the unit.

CT-E range Connection diagrams

6

<p>CT-MFE</p> <p>A1-A2 Supply: 24-240 V AC/DC</p> <p>A1-Y1 Control input 15-16/18 c/o contact</p>	<p>CT-ERE</p> <p>A1-A2 Supply: 220-240 V AC or 110-130 V AC</p> <p>A1-B1 Supply: 24 V AC/DC</p> <p>15-16/18 c/o contact</p>	<p>CT-AHE 1)</p> <p>A1(+)-A2(-) Supply: 24 V AC/DC or 110-240 V AC or 220-240 V AC</p> <p>A1-Y1 Control input 15-16/18 c/o contact</p>	<p>CT-ARE</p> <p>A1-A2 Supply: 220-240 V AC or 110-130 V AC</p> <p>A1-B1 Supply: 24 V AC/DC</p> <p>15-16/18 c/o contact</p>
--	--	---	--

<p>CT-VWE</p> <p>A1-A2 Supply: 220-240 V AC or 110-130 V AC</p> <p>A1-B1 Supply: 24 V AC/DC</p> <p>15-16/18 c/o contact</p>	<p>CT-AWE</p> <p>Device without aux. voltage</p> <p>A1(+)-A2(-) Supply: 24 V AC/DC or 110-240 V AC or 220-240 V AC</p> <p>15-16/18 c/o contact</p>	<p>CT-AWE 1)</p> <p>Device with aux. voltage</p> <p>A1-A2 Supply: 24 V AC/DC or 110-240 V AC or 220-240 V AC</p> <p>A1-Y1 Control input 15-16/18 c/o contact</p>	<p>CT-EBE</p> <p>A1-A2 Supply: 220-240 V AC or 110-130 V AC</p> <p>A1-B1 Supply: 24 V AC/DC</p> <p>15-16/18 c/o contact</p>
--	---	---	--

<p>CT-YDE</p> <p>A1-A2 Supply: 220-240 V AC or 110-130 V AC</p> <p>A1-B1 Supply: 24 V AC/DC</p> <p>15-16/18 c/o contact</p>	<p>CT-SDE</p> <p>Device: 1SVR 550 217 R4100</p> <p>A1-A2 Supply: 220-240 V AC</p> <p>A1-B1 Supply: 24 V AC/DC</p> <p>15-16/18 c/o contact</p>	<p>CT-SDE</p> <p>Devices: 1SVR 550 210 R4100, 1SVR 550 212 R4100</p> <p>A1-A2 Supply: 110-130 V AC or 380-415 V AC</p> <p>15-16/18 c/o contact</p>	<p>CT-IRE</p> <p>Supply terminals diagonally positioned</p> <p>A1-A2 Supply: 24 V AC/DC or 220-240 V AC/DC</p> <p>11-12/14 c/o contact</p>
--	--	---	---

<p>CT-IRE</p> <p>Supply terminals on one side of the device</p> <p>A1-A2 Supply: 24 V AC/DC or 220-240 V AC/DC</p> <p>11-12/14 c/o contact</p>	<p>CT-MKE</p> <p>A1-A2 Supply: 24-240 V AC/DC</p> <p>A1-A2 Thyristor</p> <p>X1-X4 Timing function adjustment</p> <p>X2-X4 Timing function adjustment</p> <p>X3-X4 Time range adjustment (Details see function diagrams)</p>	<p>CT-EKE</p> <p>A1-AL Supply: 24-240 V AC/DC</p> <p>A1-AL Thyristor</p>	<p>CT-AKE</p> <p>A1-AL Supply: 24-240 V AC</p> <p>A1-AL Thyristor</p> <p>Y2-A2 Control input</p>
---	--	---	---

CT-E range

Technical data

Technical data

Data at $T_a = 25\text{ °C}$ and rated values, unless otherwise indicated

		CT-E (relays)	CT-E (solid-state)	
Input circuit - Supply circuit				
Rated control supply voltage U_s	A1-A2, A1-AL	24-240 V AC/DC		
	A1-A2, A1-AL	24-240 V AC		
	A1-A2	110-130 V AC	-	
	A1-A2	220-240 V AC	-	
	A1-A2	380-415 V AC	-	
Rated control supply voltage U_s tolerance	A1-B1	24 V AC/DC	-	
			-15...+10 %	
Rated frequency	AC/DC versions		DC or 50/60 Hz	
	AC versions		50/60 Hz	
Typical current / power consumption	24-240 V AC/DC, 24-240 V AC		approx. 1.0-2.0 VA/W	
	110-130 V AC, 220-240 V AC	approx. 2.0 VA	-	
	380-415 V AC	approx. 3.0 VA	-	
	24 V AC/DC	approx. 1.0 VA/W	-	
Current consumption while timing		-	$\leq 2\text{ mA}$ (24-60 V AC/DC)	
			$\leq 8\text{ mA}$ (60-240 V AC/DC)	
Input circuit - Control circuit				
Kind of triggering		voltage-related triggering	-	
Control input, Control function	A1-Y1	start timing external	-	
Parallel load / polarized		no / yes ¹⁾	-	
Minimum control pulse length		20 ms	-	
Control voltage potential		see rated control supply voltage	-	
Timing circuit				
Time ranges	1 of 5 time ranges per single function device	0.05-1 s / 0.1-10 s / 0.3-30 s / 3-300 s / 0.3-30 min		
	8 time ranges 0.05 s - 100 h (CT-MFE)	1.) 0.05-1 s	2.) 0.5-10 s	-
		3.) 5-100 s	4.) 50-1000 s	
		5.) 0.5-10 min	6.) 5-100 min	
		7.) 0.5-10 h	8.) 5-100 h	
	2 time ranges 0.1-300 s (CT-MKE)			1.) 0.1-10 s
				2.) 3-300 s
	Recovery time		<50 ms	
		CT-ARE: <200 ms	CT-MKE: <100 ms	
		CT-AWE, CT-SDE: <400 ms	CT-AKE: <300 ms	
		CT-YDE: <500 ms		
Accuracy within the rated control supply voltage tolerance		$\Delta t < 0.5\% / V$		
Accuracy within the temperature range		$\Delta t < 0.1\% / \text{°C}$		
Repeat accuracy (constant parameters)		CT-MFE: $\Delta t < 0.06\% / \text{°C}$		
Star-delta transition time	CT-YDE / CT-SDE	50 ms / 30 ms	-	
Minimum energizing time	CT-ARE	200 ms	-	
Output circuit				
Kind of output	15-16/18	Relay, 1 c/o contact	-	
	A1-A2, A1-AL	-	Thyristor	
Contact material		AgCdO	-	
Rated operational voltage U_b	VDE 0110, IEC/EN 60947-1		250 V	
Maximum switching voltage		250 V AC, 250 V DC		
Rated operational current I_b (IEC/EN 60947-5-1)	AC12 (resistive) at 230 V	4 A	-	
	AC15 (inductive) at 230 V	3 A	-	
	AC15 (inductive) at 230 V	4 A	-	
	DC13 (inductive) at 24 V	2 A	-	

¹⁾ CT-MFE: yes / no

CT-E range

Technical data

6

		CT-E (relays)	CT-E (solid-state)
AC rating (UL 508)	Utilization category (Control Circuit Rating Code)	B 300	-
	max. rated operational voltage	300 V AC	-
	Maximum continuous thermal current at B300	5 A	-
	max. making/breaking apparent power at B300	3600 VA / 360 VA	-
Mechanical lifetime		30 x 10 ⁶ switching cycles	-
Electrical lifetime	at AC12, 230 V, 4 A	0.1 x 10 ⁶ switching cycles	-
Max. fuse rating to achieve short-circuit protection (IEC/EN 60947-5-1)	n/c contact	10 A fast-acting, CT-ARE: 5 A	-
	n/o contact	10 A fast-acting, CT-ARE: 5 A	-
Minimum load current		-	CT-MKE: 20 mA CT-EKE, CT-AKE: 10 mA
Maximum load current		-	CT-MKE: ≤ 0.8 A at Ta = ≤ 20 °C CT-EKE, CT-AKE: ≤ 0.7 A
Load current reduction / Derating		-	10 mA/°C
Maximum surge current		-	CT-MKE: 20 A for t 20 ms CT-EKE, CT-AKE: 15 A
Voltage drop in connected state		-	≤ 3 V
Cable length between solid-state timer and connected load at 50 Hz and a cable capacity of 100 pF/m :	at 24 V AC	-	220 m / 22 nF
	at 42 V AC	-	100 m / 10 nF
	at 60 V AC	-	65 m / 6.5 nF
	at 110 V AC	-	50 m / 5 nF
	at 240 V AC	-	22 m / 2.2 nF
General data			
Duty time		100%	
Dimensions (W x H x D)		22.5 x 78.5 x 78 mm (0.886 x 3.09 x 3.07 in)	
Weight		approx. 80 g (0.176 lb)	
Mounting		DIN rail (IEC/EN 60715)	
Mounting position		any	
Minimum distance to other units	horizontal / vertical	no / no	
Degree of protection	housing / terminals	IP50 / IP20	
Electrical connection			
Wire size	fine-strand with wire end ferrule	2 x 0.75-1.5 mm ² (2 x 18-16 AWG)	
	fine-strand without wire end ferrule	2 x 1-1.5 mm ² (2 x 18-16 AWG)	
	rigid	2 x 0.75-1.5 mm ² (2 x 18-16 AWG)	
Stripping length		10 mm (0.39 in)	
Tightening torque		0.6-0.8 Nm	
Environmental data			
Ambient temperature ranges	operation / storage	-20...+60 °C / -40...+85 °C	
Damp heat	IEC 68-2-30	24 h cycles, 55 °C, 93 % rel., 96 h	
Operational reliability	IEC 68-2-6	6 g	
Mechanical resistance	IEC 68-2-6	10 g	
Isolation data			
Rated impulse withstand voltage U _{imp} between all isolated circuits	VDE 0110, IEC/EN 664	4 kV; 1.2/50 µs	
Pollution category	VDE 0110, IEC 664, IEC 255-5	III/C	
Overvoltage category	VDE 0110, IEC 664, IEC 255-5	III/C	
Rated insulation voltage U _i between supply circuit, control circuit and output circuit	input circuit / output circuit	300 V (supply up to 240 V)	
	type test	500 V (supply up to 440 V)	
Test voltage between all isolated circuits		2.5 kV, 50 Hz, 1 s	
Standards			
Product standard		IEC 61812-1, EN 61812-1 + A11, DIN VDE 0435 Teil 201	
Low Voltage Directive		2006/95/EC	
EMC Directive		2004/108/EC	
Electromagnetic compatibility			
Interference immunity to		IEC/EN 61000-6-2	
electronic discharge	IEC/EN 61000-4-2	Level 3 (6 kV / 8 kV)	
radiated, radio-frequency electromagnetic field	IEC/EN 61000-4-3	Level 3 (10 V/m)	
electrical fast transient/burst surge	IEC/EN 61000-4-4	Level 3 (2 kV / 5 kHz)	
conducted disturbances, induced by radio-frequency fields	IEC/EN 61000-4-5	Level 3 (2 kV L-L)	
	IEC/EN 61000-4-6	Level 3 (10 V)	
Interference emissions		IEC/EN 61000-6-4	

CT-E range Technical diagrams

Technical diagrams

Load limit curves
AC load (resistive)

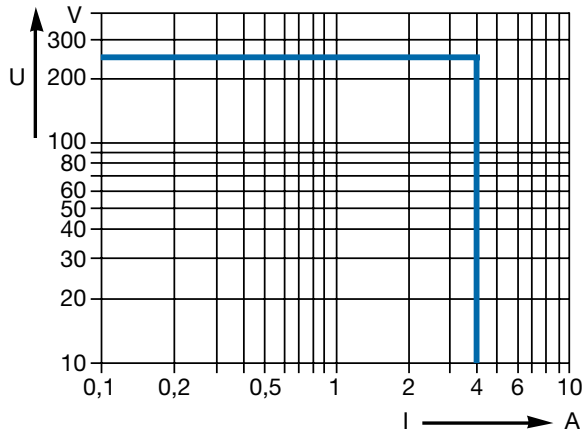

DC load (resistive)

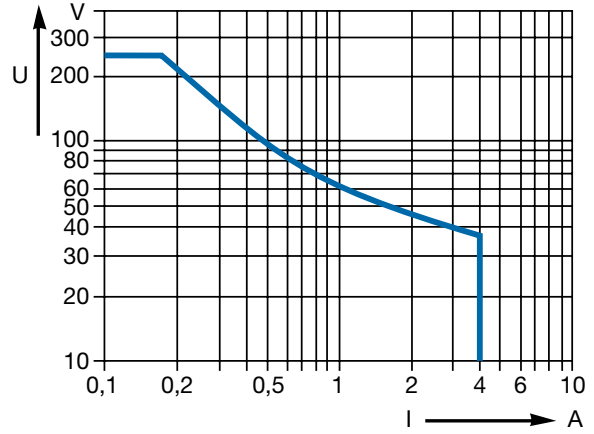

6

Derating factor F for inductive AC load

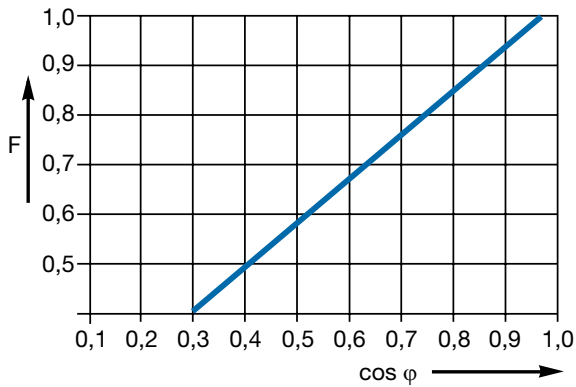

Contact lifetime

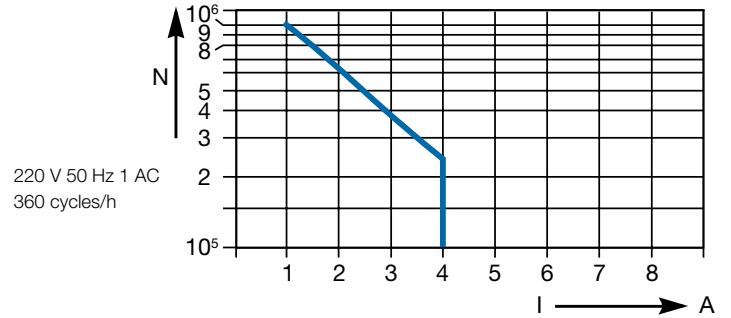

CT-E range

Wiring notes

Approximate dimensions

Wiring notes

for single-function devices with control contact
(CT-AHE, CT-AWE with auxiliary voltage)

6

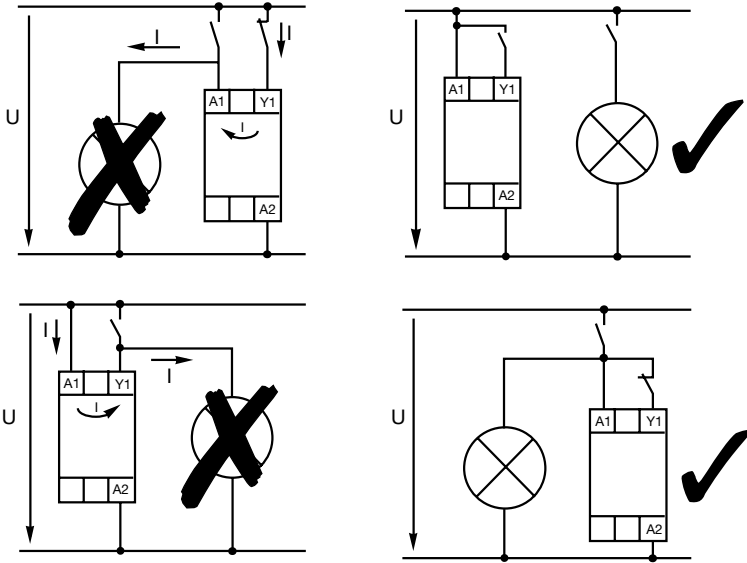

Dimensional drawing

Dimensions in mm

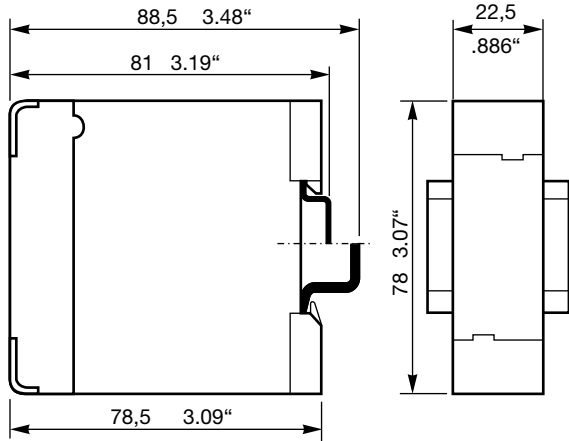

CT-S Range Electronic timers



CT-S range

Benefits and advantages

Characteristics

- Diversity:
 - 8 multifunction timers
 - 13 single-function timers
 - 8 switching relays
- Control supply voltages:
 - Multi range: 24-48 V DC, 24-240 V AC
 - Wide range: 24-240 V AC/DC
 - Single range: 380-440 V AC
- Innovative connection technology
 - Double-chamber cage connection terminals
 - Easy Connect Technology
- Devices with:
 - 1 or 2 c/o contacts
 - 2nd c/o contact can be selected as instantaneous contact ¹⁾
 - Remote potentiometer connection ¹⁾
 - Control input with volt-free or voltage-related triggering e.g. to start timing, pause timing
 - Extended operating temperature range down to -40 °C ¹⁾
- Sealable transparent cover for protection against unauthorized changes of time values
- Integrated marker label
- Approvals / Marks (partly pending)



¹⁾ selected devices

6

Synonyms

used expression	alternative expression(s)	used expression	alternative expression(s)
1 c/o contact	SPDT	voltage-related	wet / non-floating
2 c/o contacts	DPDT	volt-free	dry / floating

Benefits

Easy Connect Technology ^①

Tool-free wiring and excellent vibration resistance. Push-in terminals provide connection of wires up to 2 x 0,5 - 1,5 mm² (2 x 20 - 16 AWG), rigid or fine-strand with or without wire end ferrules.

Double-chamber cage connection terminals ^②

Double-chamber cage connection terminals provide connection of wires up to 2 x 0,5-2,5 mm² (2 x 20-14 AWG) rigid or fine-strand, with or without wire end ferrules. Potential distribution does not require additional terminals.

Snap-On housing

Tool-free DIN rail installation and deinstallation of the Electronic Timer with Snap-On housing.

Time range preselection and fine adjustment ^③

Direct assignment of the preselected time range to the fine adjustment potentiometer scale by multicolor scales.

LEDs for status indication ^④

All actual operational states are displayed by front-face LED's, thus simplifying commissioning and troubleshooting.

Integrated marker label ^⑤

Integrated marker labels allow the product to be marked quickly and simply. No additional marker labels are required.

Sealable transparent cover ^⑥

Protection against unauthorized changes of time and threshold values. Available as an accessory.

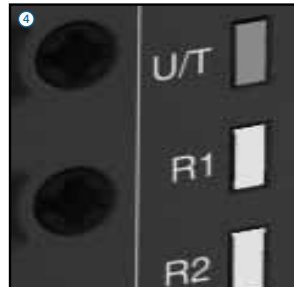
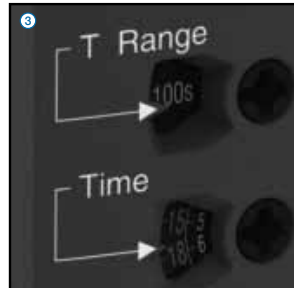
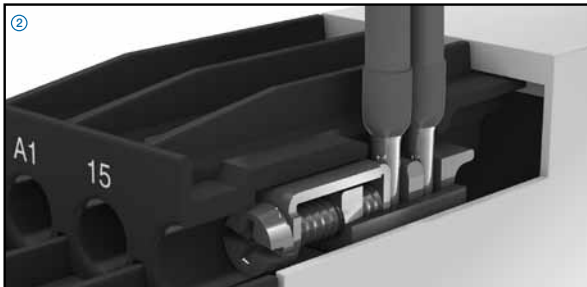
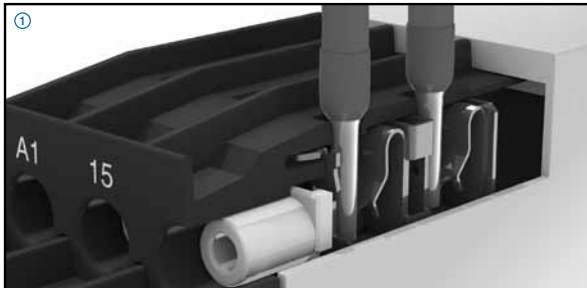

CT-S range Conversion table



Previous Generation

1SVR630010R0200	CT-MFS.21
1SVR630010R3200	CT-MBS.22
1SVR630020R0200	CT-MVS.21
1SVR630020R3100	CT-MVS.12
1SVR630020R3300	CT-MVS.22
1SVR630021R2300	CT-MVS.23
1SVR630030R3300	CT-MXS.22
1SVR630040R3300	CT-WBS.22
1SVR630100R0300	CT-ERS.21
1SVR630100R3100	CT-ERS.12
1SVR630100R3300	CT-ERS.22
1SVR630110R3300	CT-AHS.22
1SVR630120R3100	CT-ARS.11
1SVR630120R3300	CT-ARS.21
1SVR630180R0300	CT-APS.21
1SVR630180R3100	CT-APS.12
1SVR630180R3300	CT-APS.22
1SVR630210R3300	CT-SDS.22
1SVR630211R2300	CT-SDS.23

New Generation

Double-chamber cage connection terminals

1SVR730010R0200	CT-MFS.21S
1SVR730010R3200	CT-MBS.22S
1SVR730020R0200	CT-MVS.21S
1SVR730020R3100	CT-MVS.12S
1SVR730020R3300	CT-MVS.22S
1SVR730021R2300	CT-MVS.23S
1SVR730030R3300	CT-MXS.22S
1SVR730040R3300	CT-WBS.22S
1SVR730100R0300	CT-ERS.21S
1SVR730100R3100	CT-ERS.12S
1SVR730100R3300	CT-ERS.22S
1SVR730110R3300	CT-AHS.22S
1SVR730120R3100	CT-ARS.11S
1SVR730120R3300	CT-ARS.21S
1SVR730180R0300	CT-APS.21S
1SVR730180R3100	CT-APS.12S
1SVR730180R3300	CT-APS.22S
1SVR730210R3300	CT-SDS.22S
1SVR730211R2300	CT-SDS.23S

Easy Connect Technology

1SVR740010R0200	CT-MFS.21P
1SVR740010R3200	CT-MBS.22P
1SVR740020R0200	CT-MVS.21P
1SVR740020R3100	CT-MVS.12P
1SVR740020R3300	CT-MVS.22P
1SVR740021R2300	CT-MVS.23P
1SVR740030R3300	CT-MXS.22P
1SVR740040R3300	CT-WBS.22P
1SVR740100R0300	CT-ERS.21P
1SVR740100R3100	CT-ERS.12P
1SVR740100R3300	CT-ERS.22P
1SVR740110R3300	CT-AHS.22P
1SVR740120R3100	CT-ARS.11P
1SVR740120R3300	CT-ARS.21P
1SVR740180R0300	CT-APS.21P
1SVR740180R3100	CT-APS.12P
1SVR740180R3300	CT-APS.22P
1SVR740210R3300	CT-SDS.22P
1SVR740211R2300	CT-SDS.23P

ABB's electronic timers in a new housing Benefits at a glance

Double-chamber cage connection terminals

Easy conversions:

The predecessor range of electronic timers is replaced by an identical range of electronic timers with double-chamber cage connection terminals.

The Reference code has changed in one digit only:

1SVRx changed to 1SVR7.

Ratings:

Double-chamber cage connection terminals provide connection of wires up to 1 x 0,5-4 mm² (1 x 20-12 AWG) or 2 x 0,5-2,5 mm² (2 x 20-14 AWG) rigid or 1 x 0,5-2,5 mm² (1 x 20-14 AWG) / 2 x 0,5-1,5 mm² (2 x 20 -16 AWG), rigid or fine-strand, with or without wire end ferrules. Potential distribution does not require additional terminals.

Extended type designators

The references with push-in terminals or screw terminals can be differentiated easily by the extended type designator:

CT-xxS.xxS indicates the screw terminal

CT-xxS.xxP indicates the push-in terminal

Easy Connect Technology

New Options:

In addition to our existing well established screw connections, ABB introduces a new innovative connection technology: Easy Connect Technology with push-in terminals.

Tool-Free Wiring:

The push-in terminals can be wired with rigid or fine-strand wires with wire end ferrules totally tool-free. The connection direction is exactly the same as for the screw version.

Higher utility class:

The Easy Connect Technology provides excellent vibration resistance with gas tight push-in terminals – the right solution for harsh environment.

Ratings:

Push-in terminals provide connection of wires up to 2 x 0,5 - 1,5 mm² (2 x 20-16 AWG), rigid or fine-strand with or without wire end ferrules.

CT-S range Ordering details



CT-MVS.21P

Description

The highly sophisticated CT-S range in ABB's new S-range housing offers two different types of connection terminals and is ideally suited for universal use. Two different connection technologies are available:

- Double-chamber cage connection terminals:
- Easy Connect Technology:

Accessories:

The CT-S range offers the possibility of using accessories such as a remote potentiometer to adjust the time delay or a sealable, transparent cover to protect against unauthorized changes of time and threshold values.

Ordering details



CT-MBS.22P

Time function	Rated control supply voltage	Time ranges	Control input	Output	Reference code	Catalog number	Weight (1 pce) kg (lb)
	24-240 V AC/DC ²⁾ ³⁾ ⁴⁾	10 (0.05 s-300 h)	■	2 c/o	CT-MVS.21S	1SVR730020R0200	0.148 (0.326)
					CT-MVS.21P	1SVR740020R0200	0.136 (0.300)
	CT-MVS.22S				1SVR730020R3300	0.142 (0.313)	
	CT-MVS.22P				1SVR740020R3300	0.131 (0.289)	
	CT-MVS.23S				1SVR730021R2300	0.144 (0.317)	
	CT-MVS.23P				1SVR740021R2300	0.133 (0.293)	
	24-48 V DC, 24-240 V AC	10 (0.05 s-300 h)	■	1 c/o	CT-MVS.12S	1SVR730020R3100	0.107 (0.236)
					CT-MVS.12P	1SVR740020R3100	0.102 (0.225)
	24-48 V DC, 24-240 V AC ⁵⁾	2 x 10 (0.05 s-300 h)	■	2 c/o	CT-MXS.22S	1SVR730030R3300	0.142 (0.313)
					CT-MXS.22P	1SVR740030R3300	0.131 (0.289)
	24-240 V AC/DC ²⁾ ³⁾ ⁴⁾	10 (0.05 s-300 h)	◇/◇	2 c/o	CT-MFS.21S	1SVR730010R0200	0.145 (0.320)
					CT-MFS.21P	1SVR740010R0200	0.133 (0.293)
	CT-MBS.22S				1SVR730010R3200	0.140 (0.309)	
	CT-MBS.22P				1SVR740010R3200	0.129 (0.284)	

- ON-delay (accumulative)
OFF-delay without aux. voltage
- Impulse-ON
- Impulse-OFF
- Symmetrical ON-delay and OFF-delay
- Flasher starting with ON
- Flasher starting with OFF
- Pulse generator starting
- Star-delta change-over with impulse
- Pulse former
- ON/OFF-function
- Star-delta change-over twice ON-delayed with ON or OFF
- Pulse generator starting with ON or OFF
- Single-pulse generator
- Impulse-ON/OFF
- Flasher starting with ON
- Flasher starting with OFF
- fixed impulse with adjustable time delay
- Adjustable impulse with fixed time delay

- 1) Asymmetrical ON- and OFF-delay
- 2) Extended temperature range -40 °C
- 3) Remote potentiometer connection
- 4) 2nd c/o contact selectable as instantaneous contact
- 5) 2 remote potentiometer connections

- Control input with voltage-related triggering
- ◇ Control input with volt-free triggering

CT-S range

Ordering details















CT-ERS.21P















CT-AHS.22P





CT-SDS.23P

-  ON-delay (accumulative)
-  OFF-delay without aux. voltage
-  Impulse-ON
-  Flasher starting with ON
-  Flasher starting with OFF
-  ON/OFF-function
-  Impulse-ON/OFF
-  Flasher starting with ON
-  Flasher starting with OFF
-  fixed impulse with adjustable time delay
-  Adjustable impulse with fixed time delay
-  Star-delta change-over

Time function	Rated control supply voltage	Time ranges	Control input	Output	Reference code	Catalog number	Weight (1 pce) kg (lb)	
     	24-48 V DC, 24-240 V AC	10 (0.05 s- 300 h)		2 c/o	CT-WBS.22S	1SVR730040R3300	0.123 (0.271)	
					CT-WBS.22P	1SVR740040R3300	0.115 (0.254)	
	24-240 V AC/ DC 2)	10 (0.05 s- 300 h)		2 c/o	CT-ERS.21S	1SVR730100R0300	0.130 (0.287)	
	24-48 V DC, 24-240 V AC				CT-ERS.21P	1SVR740100R0300	0.121 (0.267)	
					CT-ERS.22S	1SVR730100R3300	0.121 (0.267)	
	24-48 V DC, 24-240 V AC				CT-ERS.22P	1SVR740100R3300	0.113 (0.249)	
					1 c/o	CT-ERS.12S	1SVR730100R3100	0.106 (0.234)
	CT-ERS.12P				1SVR740100R3100	0.101 (0.222)		
	24-240 V AC/ DC 2)	10 (0.05 s- 300 h)		2 c/o	CT-APS.21S	1SVR730180R0300	0.146 (0.322)	
	24-48 V DC, 24-240 V AC				CT-APS.21P	1SVR740180R0300	0.125 (0.276)	
					CT-APS.22S	1SVR730180R3300	0.138 (0.304)	
	24-48 V DC, 24-240 V AC				CT-APS.22P	1SVR740180R3300	0.127 (0.280)	
					1 c/o	CT-APS.12S	1SVR730180R3100	0.109 (0.240)
	24-48 V DC, 24-240 V AC				CT-APS.12P	1SVR740180R3100	0.103 (0.227)	
					10 (0.05 s- 300 h)		CT-AHS.22S	1SVR730110R3300
	CT-AHS.22P					1SVR740110R3300	0.125 (0.276)	
 6)	24-240 V AC/DC	7 (0.05 s- 10 min)		1 c/o	CT-ARS.11S	1SVR730120R3100	0.106 (0.234)	
					CT-ARS.11P	1SVR740120R3100	0.100 (0.220)	
					2 c/o	CT-ARS.21S	1SVR730120R3300	0.124 (0.273)
						CT-ARS.21P	1SVR740120R3300	0.115 (0.254)
 6)	110-127 V AC or 110 V DC 8)				CT-VBS.17	1SVR430261R6000	0.123 (0.271)	
	200-240 V AC/DC 8)				CT-VBS.18	1SVR430261R5000	0.118 (0.260)	
 7)	24-48 V DC, 24-240 V AC	7 (0.05 s- 10 min)		2 n/o	CT-SDS.22S	1SVR730210R3300	0.114 (0.251)	
	380-440 V AC				CT-SDS.22P	1SVR740210R3300	0.108 (0.238)	
					CT-SDS.23S	1SVR730211R2300	0.118 (0.260)	
	CT-SDS.23P				1SVR740211R2300	0.112 (0.247)		

- 1) Asymmetrical ON- and OFF-delay
- 2) Extended temperature range -40 °C
- 3) Remote potentiometer connection
- 4) 2nd c/o contact selectable as instantaneously contact
- 5) 2 remote potentiometer connections
- 6) Without auxiliary voltage
- 7) 50 ms transition time
- 8) For DC contactor coils

-  Control input with voltage-related triggering
-  Control input with volt-free triggering

CT-S range Ordering details



CT-IRS.35

6



ON/OFF-function

Time function	Rated control supply voltage	Time ranges	Control input	Output	Reference code	Catalog number	Weight (1 pce) kg (lb)	
□	24 V AC/DC			2 c/o	CT-IRS.16	1SVR430220R9100	0.121 (0.267)	
	110-240 V AC				CT-IRS.14	1SVR430221R7100	0.126 (0.278)	
	24 V AC/DC				CT-IRS.26	1SVR430220R9300	0.135 (0.298)	
	110-240 V AC				CT-IRS.24	1SVR430221R7300	0.141 (0.311)	
	24 V AC/DC			2 c/o	CT-IRS.26G ⁹⁾	1SVR430230R9300	0.147 (0.324)	
	110-240 V AC				CT-IRS.24G ⁹⁾	1SVR430231R7300	0.150 (0.331)	
	24 V AC/DC				3 c/o	CT-IRS.36	1SVR430220R9400	0.159 (0.351)
	220-240 V AC					CT-IRS.35	1SVR430221R1400	0.161 (0.355)

⁹⁾ Contacts with gold-plated contacts

CT-S range

Ordering details

Accessories

Remote potentiometer

50 k Ω \pm 20 % - 0,2 Ω , degree of protection IP66

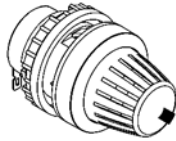

MT-x50B



30 mm adapters

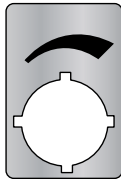

Marker label 29.6 x 44.5 mm

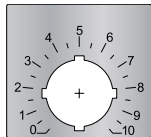

Marker label with scale 0-10
48.5 x 44.5 mm

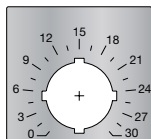

Marker label with scale 0-30
48.5 x 44.5 mm

Material	Diameter in mm	Reference code	Catalog number	Pack.- unit pieces	Weight 1 piece g / oz
Plastic, black	22.5	MT-150B	1SFA611410R1506	1	0.040
Plastic, chrome	22.5	MT-250B	1SFA611410R2506	1	0.040
Metal, chrome	22.5	MT-350B	1SFA611410R3506	1	0.048

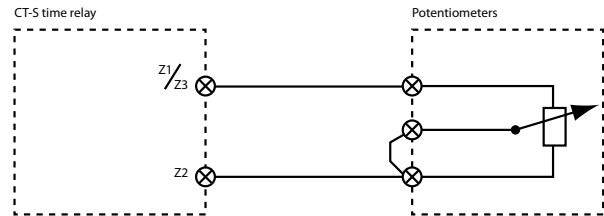
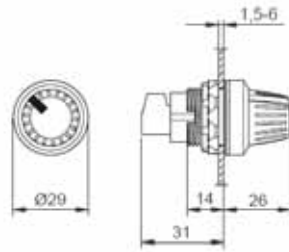

Note: The connections of the potentiometer are not marked.

30 mm adapter for attaching the potentiometer 22 mm in 30 mm mounting hole

Material	Reference code	Catalog number	Pack.- unit pieces	Weight 1 piece g / oz
Plastic, black	KA1-8029	1SFA616920R8029	1	
Metal, chrome	KA1-8030	1SFA616920R8030	1	

Marker label

Caption	Reference code	Catalog number	Pack.- unit pieces	Weight 1 piece g / oz
Symbol (see illustration)	SK 615 562-87	GJD6155620R0087	1	0.002
Scale 0 - 10	SK 615 562-88	GJD6155620R0088	1	0.002
Scale 0 - 30	MA16-1060	1SFA611940R1060	1	0.002

CT-S range

Ordering details

Accessories

6

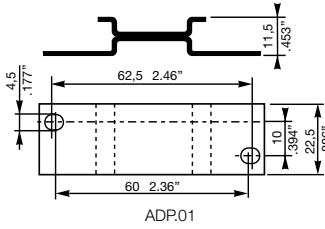

ADP.01

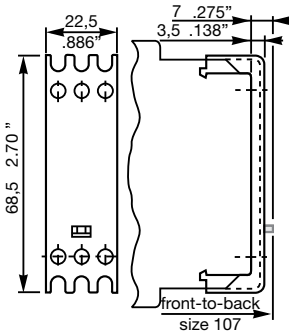

COV.01

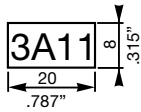

MAR.01

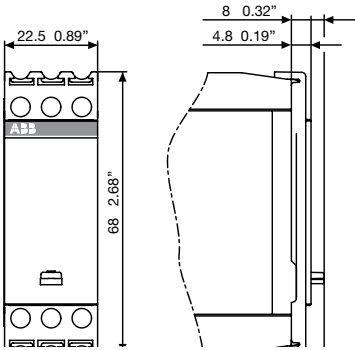

COV.11

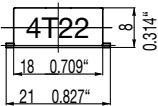

MAR.02

Accessories

Material	for devices	Reference code	Catalog number	Pack.-unit pieces	Weight 1 piece g / oz
Adapter for screw mounting ¹⁾	CT-S 22.5 mm	ADP.01	1SVR430029R0100	1	18.4/0.65
Sealable transparent cover		COV.01	1SVR430005R0100	1	5.2/0.18
Sealable transparent cover ¹⁾	CT-S.S/P 22.5 mm	COV.11	1SVR730005R0100	1	4 / 0.129

Marker label

Material	for devices	Reference code	Catalog number	Pack.-unit pieces	Weight 1 piece g / oz
Marker	CT-S without DIP switch	MAR.01	1SVR366017R0100	10	0.19/0.007
Marker	CT-S with DIP switch	MAR.02	1SVR430043R0000	10	0.13/0.005
Marker	CT-S.S/P with DIP switch	MAR.12	1SVR730006R0000	10	0.152/0.335

¹⁾ also available for CT-S.S/P

CT-S range Function diagrams

Remarks

Legend

- Control supply voltage not applied / Output contact open
- Control supply voltage applied / Output contact closed

- A1-Y1/B1 Control input with voltage-related triggering
- Y1-Z2 Control input with volt-free triggering
- X1-Z2 Control input with volt-free triggering

Remote potentiometer connection:

When an external potentiometer is connected to the remote potentiometer connection (terminals **Z1-Z2**, **Z3-Z2** respectively), the internal, front-face potentiometer is disabled and the time adjustment is made via the external potentiometer.

2nd c/o contact selectable as instantaneous contact:

When switch position Inst. "I" is selected, the functionality of the 2nd c/o contact changes to an instantaneous contact. It acts like the c/o contacts of a switching relay, i.e. applying or interrupting the control supply voltage energizes or de-energizes the c/o contact. The designation of the 2nd c/o contact changes from **25-26/28** to **21-22/24**, when selected as instantaneous contact.

Terminal designations on the device and in the diagrams:

The 1st c/o contact is always designated **15-16/18**.
 The 2nd c/o contact is designated **25-26/28**, if it responds to the time delay.
 If the 2nd c/o contact is selected as an instantaneous contact, the designation **25-26/28** is replaced by **21-22/24**.
 Control supply voltage is always applied to terminals **A1-A2**.

Function of the yellow LEDs:

On devices without the function '2nd c/o contact selectable as instantaneous contact', the yellow LED **R** glows as soon as the output relay energizes and turns off when the output relay de-energizes.

Devices with the function '2nd c/o contact selectable as instantaneous contact' have two yellow LEDs, designated **R1** and **R2**. LED **R1** shows the status of the 1st c/o contact (**15-16/18**) and LED **R2** shows the status of the 2nd c/o contact (**25-26/28**, **21-22/24** resp.). LED **R1** or **R2** glow as soon as the corresponding output relay energizes and turns off when the corresponding output relay de-energizes.

⊗ ON-delay (Delay on make) CT-MVS, CT-ERS, CT-WBS

This function requires continuous control supply voltage for timing. Timing begins when control supply voltage is applied. The green LED flashes during timing. When the selected time delay is complete, the output relay energizes and the flashing green LED turns steady. If control supply voltage is interrupted, the output relay de-energizes and the time delay is reset.

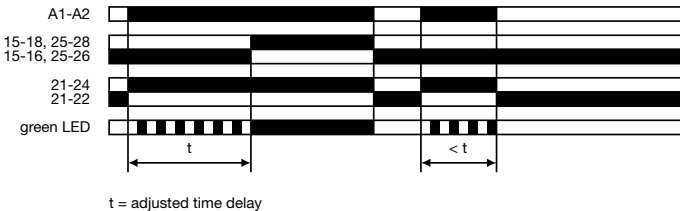

⊗ ON-delay (Delay on make) CT-MFS, CT-MBS

This function requires continuous control supply voltage for timing. If control input **Y1-Z2** is open, timing begins when control supply voltage is applied. Or, if control supply voltage is already applied, opening control input **Y1-Z2** also starts timing. The green LED flashes during timing. When the selected time delay is complete, the output relay energizes and the flashing green LED turns steady. If control input **Y1-Z2** closes before the time delay is complete, the time delay is reset and the output relay remains de-energized. Pause timing / Accumulative ON-delay (CT-MFS): Timing can be paused by closing control input **X1-Z2**. The elapsed time t_1 is stored and continues from this time value when **X1-Z2** is re-opened. This can be repeated as often as required. If control supply voltage is interrupted, the output relay de-energizes and the time delay is reset.

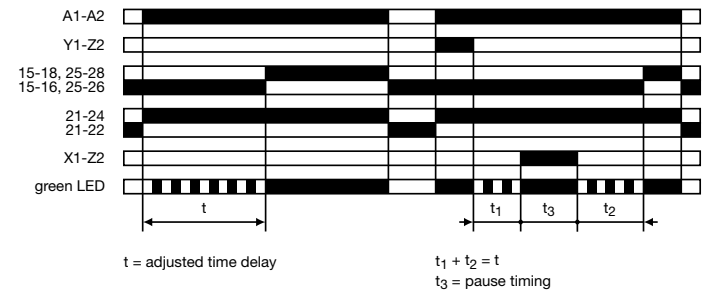

CT-S range Function diagrams

☒+ Accumulative ON-delay (Accumulative delay on make) CT-MVS

This function requires continuous control supply voltage for timing. Timing begins when control supply voltage is applied. The green LED flashes during timing. When the selected time delay is complete, the output relay energizes and the flashing green LED turns steady.

Timing can be paused by closing control input **A1-Y1/B1**. The elapsed time t_1 is stored and continues from this time value when **A1-Y1/B1** is re-opened.

This can be repeated as often as required.

6 If control supply voltage is interrupted, the output relay de-energizes and the time delay is reset.

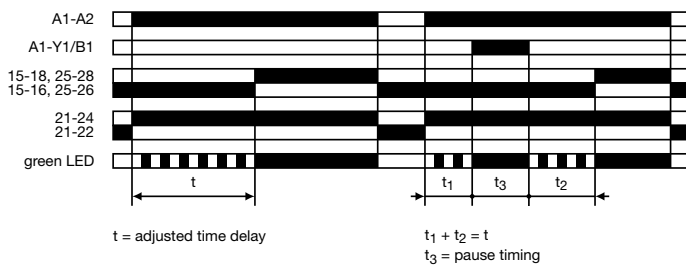

■ OFF-delay with auxiliary voltage (Delay on break) CT-MFS, CT-MBS, CT-AHS

This function requires continuous control supply voltage for timing. If control input **Y1-Z2** is closed, the output relay energizes immediately. If control input **Y1-Z2** is opened, the time delay starts. The green LED flashes during timing. When the selected time delay is complete, the output relay de-energizes and the flashing green LED turns steady.

If control input **Y1-Z2** closes before the time delay is complete, the time delay is reset and the output relay does not change state. Timing starts again when control input **Y1-Z2** re-opens.

Pause timing / Accumulative OFF-delay (CT-MFS):

Timing can be paused by closing control input **X1-Z2**. The elapsed time t_1 is stored and continues from this time value when **X1-Z2** is re-opened.

This can be repeated as often as required.

If control supply voltage is interrupted, the output relay de-energizes and the time delay is reset.

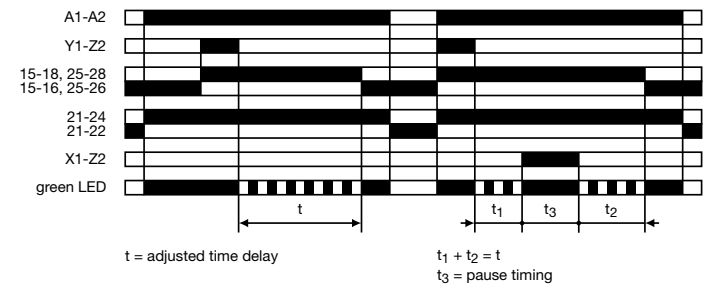

■ OFF-delay with auxiliary voltage (Delay on break) CT-MVS, CT-APS

This function requires continuous control supply voltage for timing.

If control input **A1-Y1/B1** is closed, the output relay energizes immediately. If control input **A1-Y1/B1** is opened, the time delay starts. The green LED flashes during timing. When the selected time delay is complete, the output relay de-energizes and the flashing green LED turns steady.

If control input **A1-Y1/B1** recloses before the time delay is complete, the time delay is reset and the output relay does not change state. Timing starts again when control input **A1-Y1/B1** re-opens.

If control supply voltage is interrupted, the output relay de-energizes and the time delay is reset.

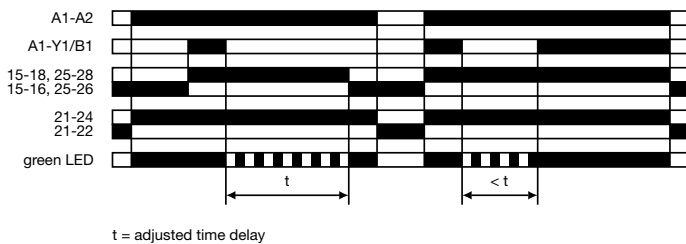

■ OFF-delay without auxiliary voltage (True delay on break) CT-ARS

The OFF-delay function without auxiliary voltage does not require continuous control supply voltage for timing. After a storage time of several months without any voltage, a formatting time of about 5 minutes is necessary.

Applying control supply voltage energizes the output relay immediately. Applied control supply voltage is displayed by the glowing green LED. If control supply voltage is interrupted, the OFF-delay starts and the LED turns off. When timing is complete, the output relay de-energizes.

For correct operation of the unit, it is necessary to complete the minimum energizing time. As soon as timing starts, the LED turns off.

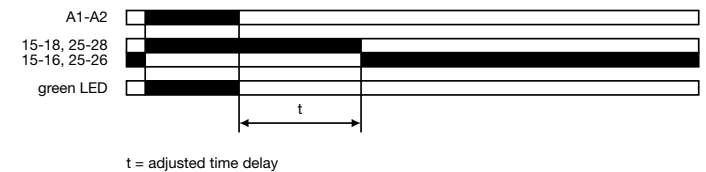

CT-S range Function diagrams

OFF-delay without auxiliary voltage for DC contactor coils CT-VBS

The DC contactor coil connected to the output is energized when control supply voltage is applied.
If control supply voltage is disconnected, the DC contactor coil remains energized for a short time delay. This time delay depends on the coil drop-out voltage and on the wattage of the contactor coil.

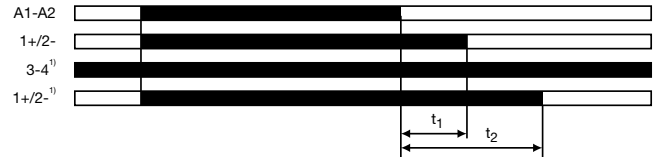

t₁ = OFF-delay (without jumper between terminals 3 and 4 ¹⁾)
t₂ = OFF-delay (with jumper between terminals 3 and 4)
¹⁾ only for version 200-240 V AC

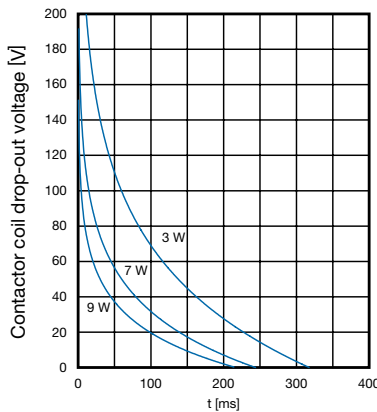

Time delay guideline values
200-240 V AC version without jumper 3/4

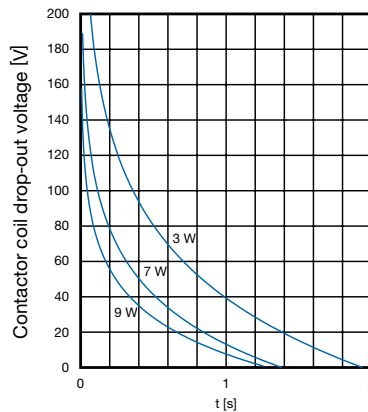

Time delay guideline values
200-240 V AC version with jumper 3/4

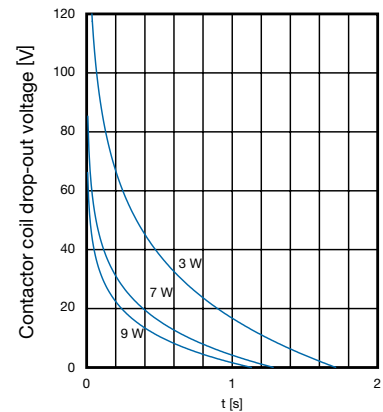

Time delay guideline values
110-127 V AC version

Symmetrical ON-delay and OFF-delay (Symmetrical delay on make and delay on break) CT-MFS, CT-MBS

This function requires continuous control supply voltage for timing.
Closing control input Y1-Z2 starts the ON-delay t₁. When timing is complete, the output relay energizes. Opening control input Y1-Z2 starts the OFF-delay t₂. Both timing functions are displayed by the flashing green LED. When the OFF-delay t₂ is complete, the output relay de-energizes.
If control input Y1-Z2 opens before the ON-delay t₁ is complete, the time delay is reset and the output relay remains de-energized. If control input Y1-Z2 closes before the OFF-delay t₂ is complete, the time delay is reset and the output relay remains energized.
Pause timing / Accumulative, symmetrical ON-delay and OFF-delay (CT-MFS): Timing can be paused by closing control input X1-Z2. The elapsed time t_{1a} or t_{2a} is stored and continues from this time value when X1-Z2 is re-opened. This can be repeated as often as required.
If control supply voltage is interrupted, the output relay de-energizes and the time delay is reset.

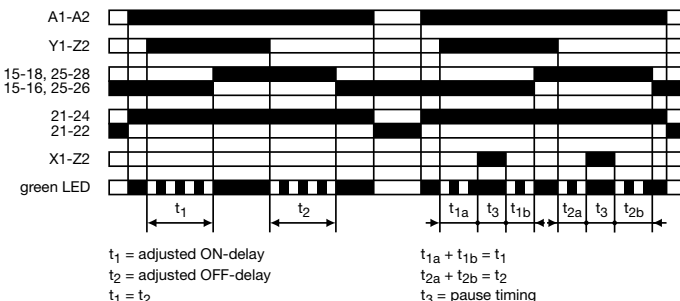

Symmetrical ON-delay and OFF-delay (Symmetrical delay on make and delay on break) CT-MVS

This function requires continuous control supply voltage for timing.
Closing control input A1-Y1/B1 starts the ON-delay t₁. When timing is complete, the output relay energizes. Opening control input A1-Y1/B1 starts the OFF-delay t₂. Both timing functions are displayed by the flashing green LED. When the OFF-delay t₂ is complete, the output relay de-energizes.
If control input A1-Y1/B1 opens before the ON-delay t₁ is complete, the time delay is reset and the output relay remains de-energized. If control input A1-Y1/B1 closes before the OFF-delay t₂ is complete, the time delay is reset and the output relay remains energized.
If control supply voltage is interrupted, the output relay de-energizes and the time delay is reset.

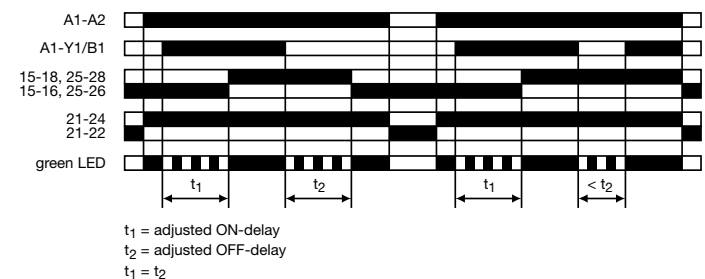

CT-S range Function diagrams

Asymmetrical ON-delay and OFF-delay (Asymmetrical delay on make and delay on break) CT-MXS

This function requires continuous control supply voltage for timing.

Closing control input **A1-Y1/B1** starts the ON-delay t_1 . When timing is complete, the output relay energizes. Opening control input **A1-Y1/B1** starts the OFF-delay t_2 . When the OFF-delay is complete, the output relay de-energizes. Both timing functions are displayed by the flashing green LED. The ON-delay and OFF-delay are independently adjustable.

If control input **A1-Y1/B1** opens before the ON-delay is complete ($<t_1$), the time delay is reset and the output relay remains de-energized.

If control input **A1-Y1/B1** closes before the OFF-delay is complete ($<t_2$), the time delay is reset and the output relay remains energized.

If control supply voltage is interrupted, the output relay de-energizes and the time delay is reset.

6

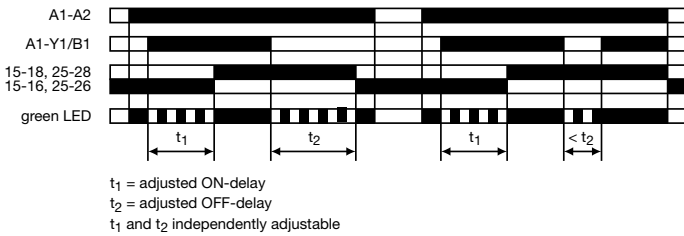

Impulse-ON (Interval) CT-MVS, CT-WBS

This function requires continuous control supply voltage for timing.

The output relay energizes immediately when control supply voltage is applied and de-energizes after the set pulse time is complete. The green LED flashes during timing. When the selected pulse time is complete, the flashing green LED turns steady.

If control supply voltage is interrupted, the output relay de-energizes and the time delay is reset.

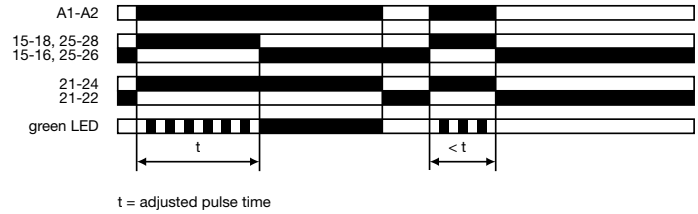

Impulse-ON (Interval) CT-MFS, CT-MBS

This function requires continuous control supply voltage for timing.

The output relay energizes immediately when control supply voltage is applied and de-energizes after the set pulse time is complete. If control input **Y1-Z2** is open, timing begins when control supply voltage is applied. Or, if control supply voltage is already applied, opening control input **Y1-Z2** starts timing. The green LED flashes during timing. When the selected pulse time is complete, the output relay de-energizes and the flashing green LED turns steady.

Closing control input **Y1-Z2**, before the pulse time is complete, de-energizes the output relay and resets the pulse time.

Pause timing / Accumulative impulse-ON (CT-MFS):
Timing can be paused by closing control input **X1-Z2**. The elapsed time t_1 is stored and continues from this time value when **X1-Z2** is re-opened. This can be repeated as often as required.

If control supply voltage is interrupted, the output relay de-energizes and the time delay is reset.

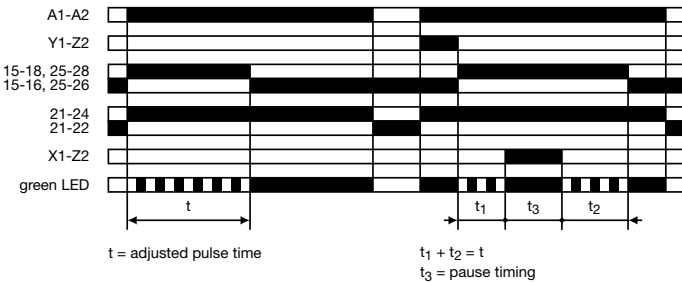

Impulse-OFF with auxiliary voltage (Trailing edge interval) CT-MFS, CT-MBS

This function requires continuous control supply voltage for timing.

If control supply voltage is applied, opening control input **Y1-Z2** energizes the output relay immediately and starts timing. The green LED flashes during timing. When the selected pulse time is complete, the output relay de-energizes and the flashing green LED turns steady.

Closing control input **Y1-Z2**, before the pulse time is complete, de-energizes the output relay and resets the pulse time.

Pause timing / Accumulative impulse-OFF (CT-MFS):
Timing can be paused by closing control input **X1-Z2**. The elapsed time t_1 is stored and continues from this time value when **X1-Z2** is re-opened. This can be repeated as often as required.

If control supply voltage is interrupted, the output relay de-energizes and the time delay is reset.

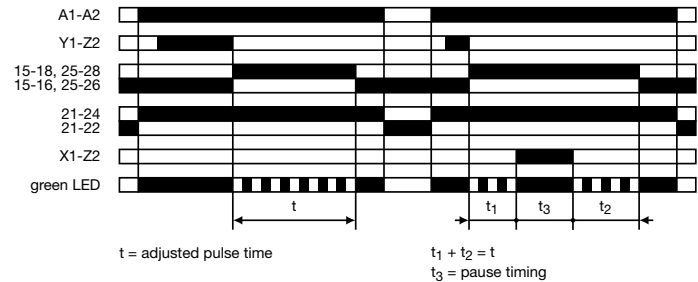

CT-S range Function diagrams

Impulse-OFF with auxiliary voltage (Trailing edge interval) CT-MVS

This function requires continuous control supply voltage for timing.
If control supply voltage is applied, opening control input **A1-Y1/B1** energizes the output relay immediately and starts timing. The green LED flashes during timing. When the selected pulse time is complete, the output relay de-energizes and the flashing green LED turns steady.
Closing control input **A1-Y1/B1**, before the pulse time is complete, de-energizes the output relay and resets the pulse time.
If control supply voltage is interrupted, the output relay de-energizes and the time delay is reset.

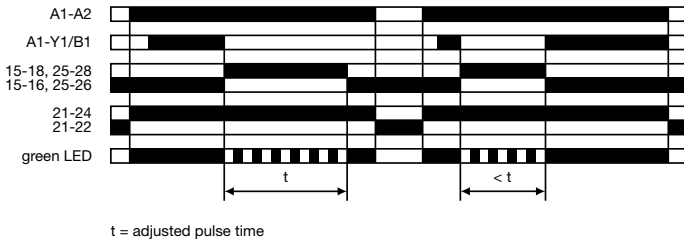

Impulse-ON and impulse-OFF (Interval and trailing edge interval) CT-MXS

This function requires continuous control supply voltage for timing.
If control supply voltage is applied, closing control input **A1-Y1/B1** energizes the output relay immediately and starts the pulse time t_1 . The green LED flashes during timing. When t_1 is complete, the output relay de-energizes and the flashing green LED turns steady.
Re-opening control input **A1-Y1/B1** energizes the output relay immediately and starts the pulse time t_2 . The green LED flashes during timing. When t_2 is complete, the output relay de-energizes and the flashing green LED turns steady. t_1 and t_2 are independently adjustable.
If control input **A1-Y1/B1** changes state before the pulse time is complete, the output relay de-energizes and the pulse time is reset. If control input **A1-Y1/B1** changes state again, the interrupted pulse time restarts.
If control supply voltage is interrupted, the output relay de-energizes and the time delay is reset.

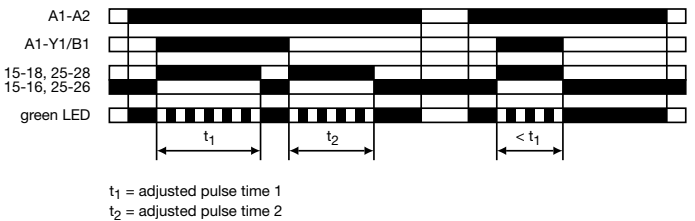

Flasher, starting with the ON time (Recycling equal times, ON first) CT-WBS

Applying control supply voltage starts timing with symmetrical ON & OFF times. The cycle starts with an ON time first. The ON & OFF times are displayed by the flashing green LED, which flashes twice as fast during the OFF time.
If control supply voltage is interrupted, the output relay de-energizes and the time delay is reset.

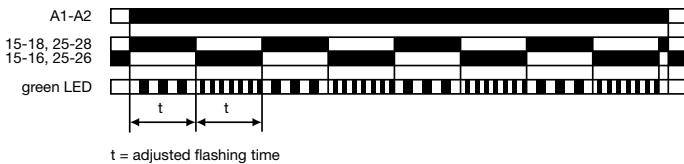

Flasher, starting with the OFF time (Recycling equal times, OFF first) CT-WBS

Applying control supply voltage starts timing with symmetrical ON & OFF times. The cycle starts with an OFF time first. The ON & OFF times are displayed by the flashing green LED, which flashes twice as fast during the OFF time.
If control supply voltage is interrupted, the output relay de-energizes and the time delay is reset.

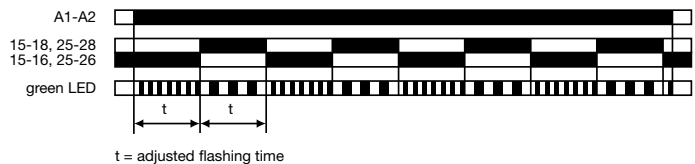

Flasher with reset, starting with the ON time (Recycling equal times with reset, ON first) CT-MFS, CT-MBS

Applying control supply voltage starts timing with symmetrical ON & OFF times. The cycle starts with an ON time first. The ON & OFF times are displayed by the flashing green LED, which flashes twice as fast during the OFF time.
The time delay can be reset by closing control input **Y1-Z2**. Opening control input **Y1-Z2** starts the timer pulsing again with symmetrical ON & OFF times.
If control supply voltage is interrupted, the output relay de-energizes and the time delay is reset.



Flasher with reset, starting with the OFF time (Recycling equal times with reset, OFF first) CT-MFS, CT-MBS

Applying control supply voltage starts timing with symmetrical ON & OFF times. The cycle starts with an OFF time first. The ON & OFF times are displayed by the flashing green LED, which flashes twice as fast during the OFF time.
The time delay can be reset by closing control input **Y1-Z2**. Opening control input **Y1-Z2** starts the timer pulsing again with symmetrical ON & OFF times.
If control supply voltage is interrupted, the output relay de-energizes and the time delay is reset.

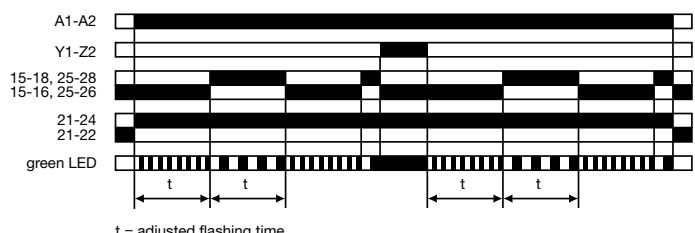

CT-S range Function diagrams



Flasher, starting with the ON or OFF time (Recycling equal times, ON or OFF first) CT-MVS

Applying control supply voltage starts timing with symmetrical ON & OFF times. The cycle starts with an ON time first.

Closing control input **A1-Y1/B1**, with control supply voltage applied, starts the cycle with an OFF time first. The ON & OFF times are displayed by the flashing green LED, which flashes twice as fast during the OFF time.

If control supply voltage is interrupted, the output relay de-energizes and the time delay is reset.

6

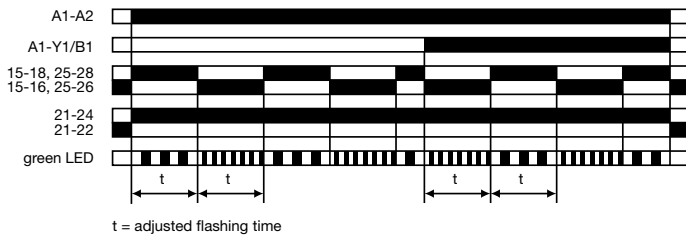

Pulse former (Single shot) CT-MFS, CT-MBS

This function requires continuous control supply voltage for timing.

Closing control input **Y1-Z2** energizes the output relay immediately and starts timing. Operating the control contact switch **Y1-Z2** during the time delay has no effect. The green LED flashes during timing. When the selected ON time is complete, the output relay de-energizes and the flashing green LED turns steady. After the ON time is complete, it can be restarted by closing control input **Y1-Z2**.

If control supply voltage is interrupted, the output relay de-energizes and the time delay is reset.

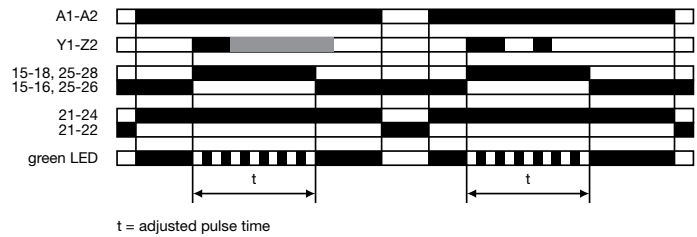

Pulse former (Single shot) CT-MVS

This function requires continuous control supply voltage for timing.

Closing control input **A1-Y1/B1** energizes the output relay immediately and starts timing. Operating the control contact switch **A1-Y1/B1** during the time delay has no effect. The green LED flashes during timing. When the selected ON time is complete, the output relay de-energizes and the flashing green LED turns steady. After the ON time is complete, it can be restarted by closing control input **A1-Y1/B1**.

If control supply voltage is interrupted, the output relay de-energizes and the time delay is reset.

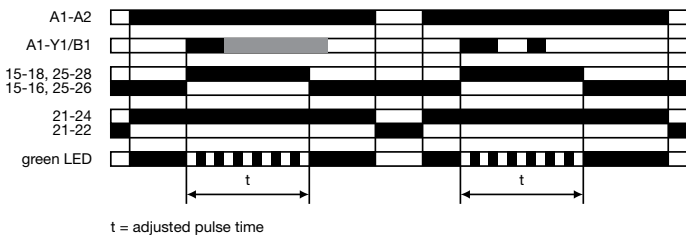

Pulse generator, starting with the ON or OFF time (Recycling unequal times, ON or OFF first) CT-MXS

This function requires continuous control supply voltage for timing.

Applying control supply voltage, with open control input **A1-Y1/B1**, starts timing with an ON time t_2 first. Applying control supply voltage, with closed control input **A1-Y1/B1**, starts timing with an OFF time t_1 first. The ON & OFF times are displayed by the flashing green LED, which flashes twice as fast during the OFF time. The ON & OFF times are independently adjustable.

If control supply voltage is interrupted, the output relay de-energizes and the time delay is reset.

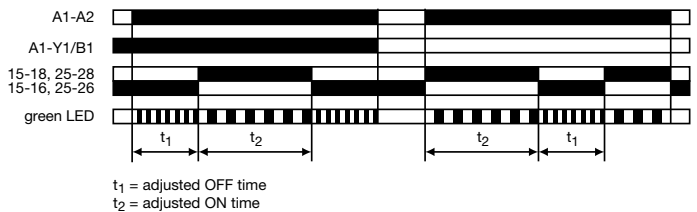

CT-S range Function diagrams

 **Single-pulse generator, starting with the OFF time (Delay on make with interval output) CT-MXS**

This function requires continuous control supply voltage for timing. Applying control supply voltage, or, if control supply voltage is already applied, opening control input **A1-Y1/B1** energizes the output relay after the OFF time t_1 is complete. When the following ON time t_2 is complete, the output relay de-energizes. The ON & OFF times are displayed by the flashing green LED, which flashes twice as fast during the OFF time.

The ON & OFF times are independently adjustable. Closing control input **A1-Y1/B1**, with control supply voltage applied, de-energizes the output relay and resets the time delay.

If control supply voltage is interrupted, the output relay de-energizes and the time delay is reset.

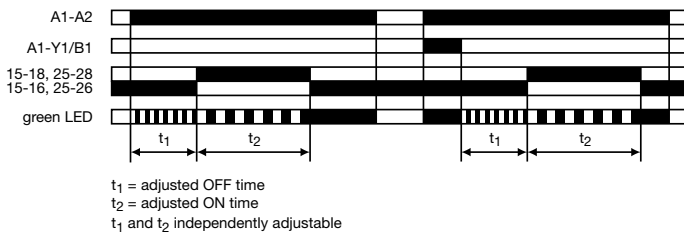

 **Fixed impulse with adjustable time delay (Delayed pulse output) CT-WBS**

This function requires continuous control supply voltage for timing. The time delay t_1 starts when control supply voltage is applied. The green LED flashes during timing. When t_1 is complete, the output relay energizes for the fixed impulse time t_2 of 500 ms and the flashing green LED turns steady.

If control supply voltage is interrupted, the time delay is reset. The output relay does not change state.

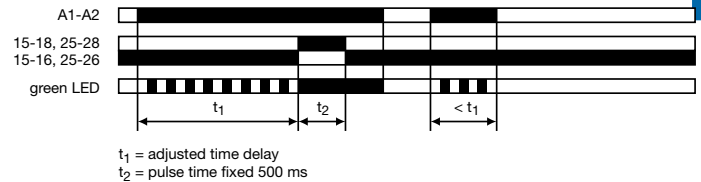

 **Adjustable impulse with fixed time delay (Delayed Interval) CT-WBS**

This function requires continuous control supply voltage for timing. Applying control supply voltage starts the fixed time delay t_2 of 500 ms. When t_2 is complete, the output relay energizes and the selected pulse time t_1 starts. The green LED flashes during timing. When t_1 is complete, the output relay de-energizes and the flashing green LED turns steady.

If control supply voltage is interrupted, the pulse time is reset. The output relay does not change state.

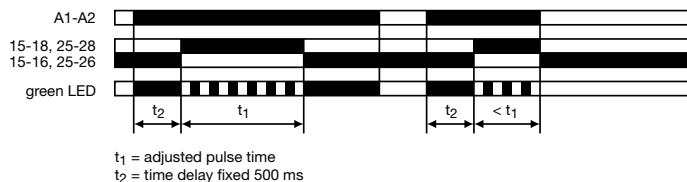

 **ON/OFF-Function CT-MFS, CT-MBS, CT-MVS, CT-MXS, CT-WBS**

This function is used for test purposes during commissioning and troubleshooting.

If the selected max. value of the time range is smaller than 300 h (front-face potentiometer "Time sector" \neq 300 h), applying control supply voltage energizes the output relay immediately and the green LED glows. Interrupting control supply voltage, de-energizes the output relay.

If the selected max. value of the time range is 300 h (front-face potentiometer "Time sector" = 300 h) and control supply voltage is applied, the green LED glows, but the output relay does not energize.

Time settings and operating of the control inputs have no effect on the operation.

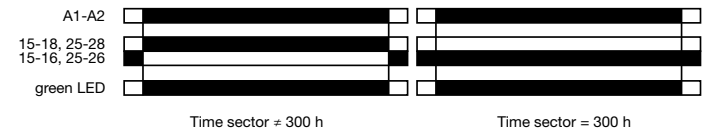

 **Switching relays CT-IRS**

The switching relay may be used to increase the number of available contacts or to reinforce contacts, or as a coupling/decoupling interface. Approx. 10 ms after applying control supply voltage to terminals **A1-A2**, the output relay energizes.

If control supply voltage is interrupted, the output relay de-energizes.



CT-S range Function diagrams

△1□ Star-delta change-over with impulse function (Star-delta starting, interval/delay on make) CT-MFS, CT-MBS, CT-MVS.2x

This function requires continuous control supply voltage for timing.
Applying control supply voltage to terminals **A1-A2**, energizes the star contactor connected to terminals **15-18** and begins the set starting time t_1 . The green LED flashes during timing. When the starting time is complete, the first c/o contact de-energizes the star contactor.
Now, the fixed transition time t_2 of 50 ms starts. When the transition time is complete, the second c/o contact energizes the delta contactor connected to terminals **25-28**. The delta contactor remains energized as long as control supply voltage is applied to the unit.

6

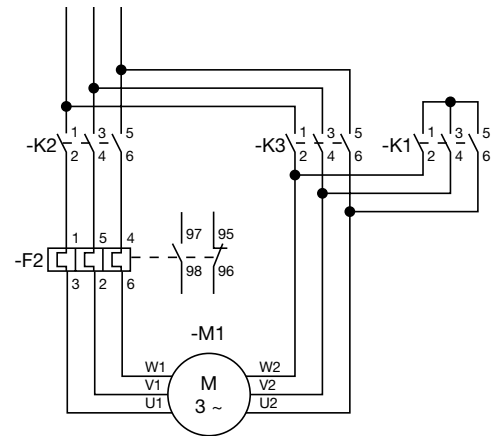
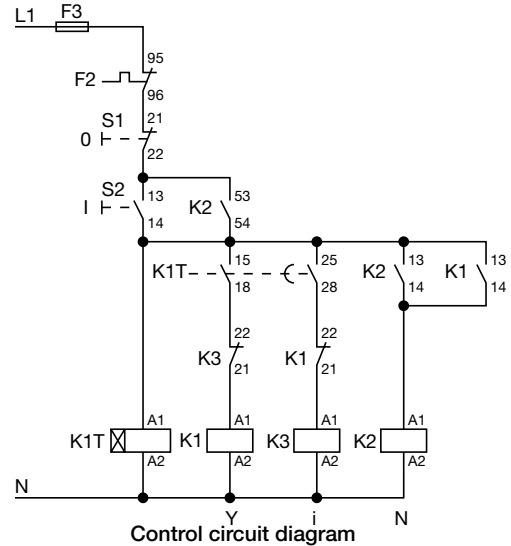
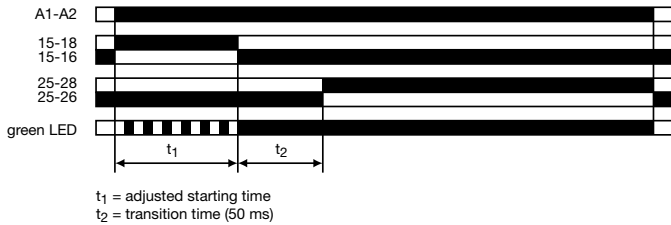

△ Star-delta change-over (Star-delta starting) CT-SDS

This function requires continuous control supply voltage for timing.
Applying control supply voltage to terminals **A1-A2**, energizes the star contactor connected to terminals **17-18** and begins the set starting time t_1 . The green LED flashes during timing. When the starting time is complete, the first output contact de-energizes the star contactor.
Now, the fixed transition time t_2 of 50 ms starts. When the transition time is complete, the second output contact energizes the delta contactor connected to terminals **17-28**. The delta contactor remains energized as long as control supply voltage is applied to the unit.

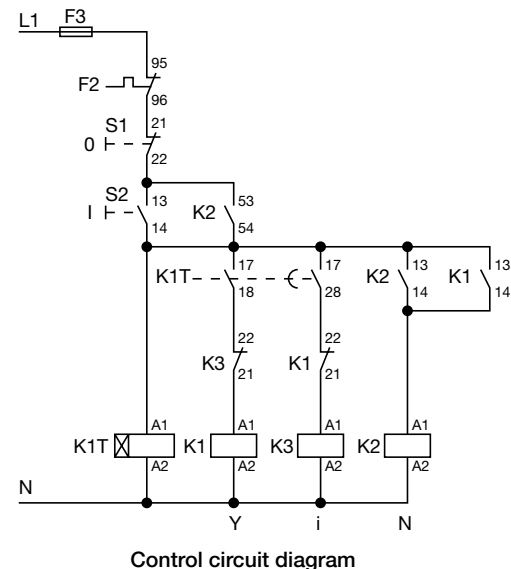
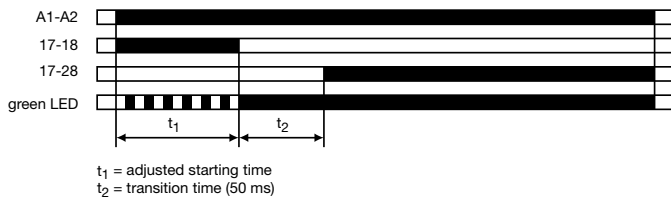

CT-S range Connection diagrams

CT-MVS.21

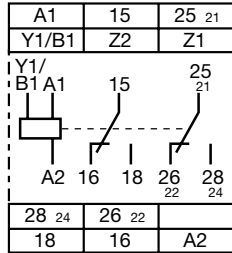

A1-A2 Supply: 24-240 V AC/DC

- 15-16/18 1. c/o contact
- 25-26/28 2. c/o contact
- 21-22/24 2. c/o contact as instantaneous contact
- A1-Y1/B1 Control input
- Z1-Z2 Remote potentiometer connection

CT-MVS.22

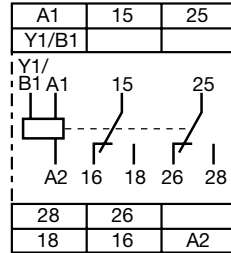

A1-A2 Supply: 24-48 V DC or 24-240 V AC

- 15-16/18 1. c/o contact
- 25-26/28 2. c/o contact
- A1-Y1/B1 Control input

CT-MVS.23

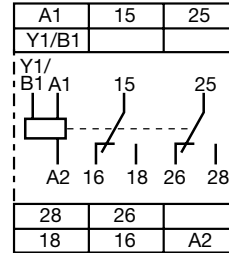

A1-A2 Supply: 380-440 V AC

- 15-16/18 1. c/o contact
- 25-26/28 2. c/o contact
- A1-Y1/B1 Control input

CT-MVS.12

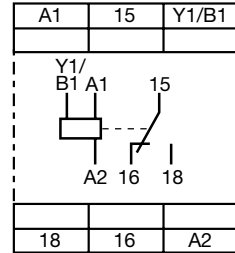

A1-A2 Supply: 24-48 V DC or 24-240 V AC

- 15-16/18 1. c/o contact
- A1-Y1/B1 Control input

CT-MXS.22

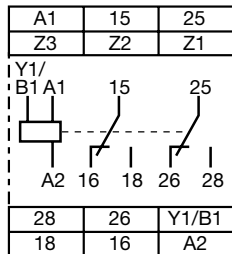

A1-A2 Supply: 24-48 V DC or 24-240 V AC

- 15-16/18 1. c/o contact
- 25-26/28 2. c/o contact
- A1-Y1/B1 Control input
- Z1-Z2 Remote potentiometer connection
- Z3-Z2 Remote potentiometer connection

CT-MFS.21

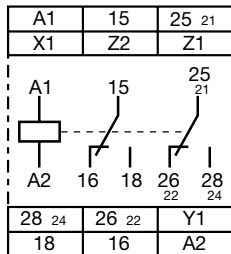

A1-A2 Supply: 24-240 V AC/DC

- 15-16/18 1. c/o contact
- 25-26/28 2. c/o contact
- 21-22/24 2. c/o contact as instantaneous contact
- Y1-Z2 Control input
- X1-Z2 Control input
- Z1-Z2 Remote potentiometer connection

CT-MBS.22

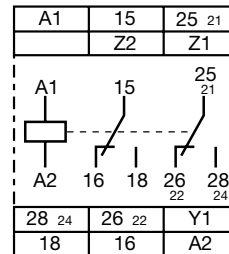

A1-A2 Supply: 24-48 V DC or 24-240 V AC

- 15-16/18 1. c/o contact
- 25-26/28 2. c/o contact
- 21-22/24 2. c/o contact as instantaneous contact
- Y1-Z2 Control input
- Z1-Z2 Remote potentiometer connection

CT-WBS.22

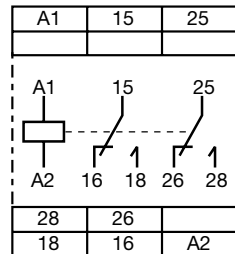

A1-A2 Supply: 24-48 V DC or 24-240 V AC

- 15-16/18 1. c/o contact
- 25-26/28 2. c/o contact

CT-ERS.21

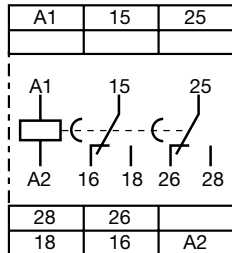

A1-A2 Supply: 24-240 V AC/DC

- 15-16/18 1. c/o contact
- 25-26/28 2. c/o contact

CT-ERS.22

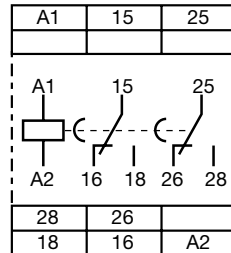

A1-A2 Supply: 24-48 V DC or 24-240 V AC

- 15-16/18 1. c/o contact
- 25-26/28 2. c/o contact

CT-ERS.12

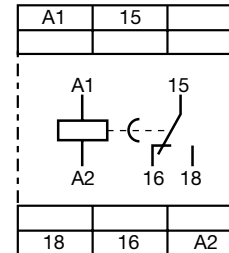

A1-A2 Supply: 24-48 V DC or 24-240 V AC

- 15-16/18 1. c/o contact

CT-S range Connection diagrams

6

CT-APS.21

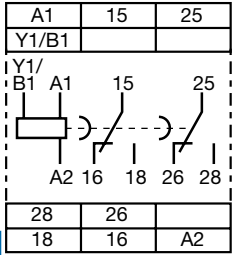

A1-A2 Supply: 24-240 V AC/DC

15-16/18 1. c/o contact
25-26/28 2. c/o contact

A1-Y1/B1 Control input

CT-APS.22

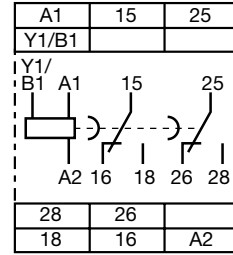

A1-A2 Supply: 24-48 V DC or 24-240 V AC

15-16/18 1. c/o contact
25-26/28 2. c/o contact

A1-Y1/B1 Control input

CT-APS.12

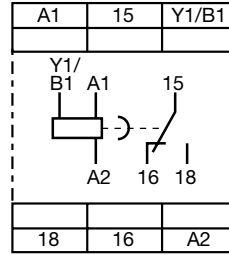

A1-A2 Supply: 24-48 V DC or 24-240 V AC

15-16/18 1. c/o contact

A1-Y1/B1 Control input

CT-AHS.22

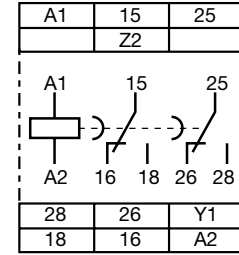

A1-A2 Supply: 24-48 V DC or 24-240 V AC

15-16/18 1. c/o contact
25-26/28 2. c/o contact

Y1-Z2 Control input

CT-ARS.11

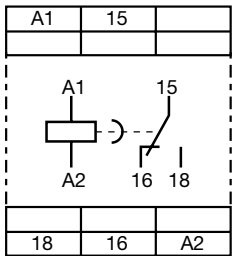

A1-A2 Supply: 24-240 V AC/DC

15-16/18 1. c/o contact

CT-ARS.21

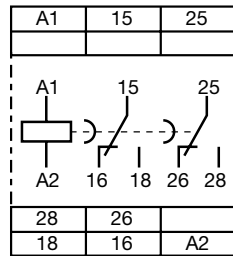

A1-A2 Supply: 24-240 V AC/DC

15-16/18 1. c/o contact
25-26/28 2. c/o contact

CT-VBS.17

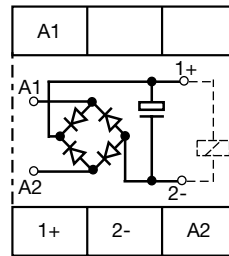

A1-A2 Supply: 110-127 V AC

1+ - 2- Contactor coil

CT-VBS.18

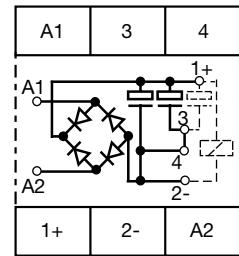

A1-A2 Supply: 200-240 V AC

1+ - 2- Contactor coil
3-4 Jumper for setting the time delay (see time delay diagram)

CT-SDS.22

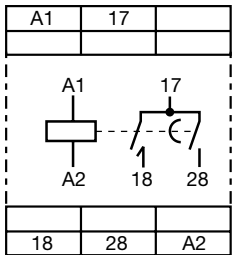

A1-A2 Supply: 24-48 V DC or 24-240 V AC

17-18 1. n/o contact
17-28 2. n/o contact

CT-SDS.23

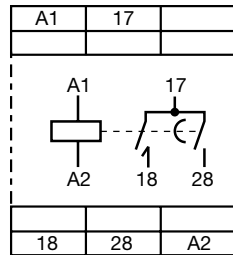

A1-A2 Supply: 380-440 V AC

17-18 1. n/o contact
17-28 2. n/o contact

CT-S range Connection diagrams

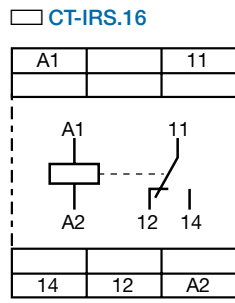

A1-A2 Supply: 24 AC/DC
11-12/14 1. c/o contact

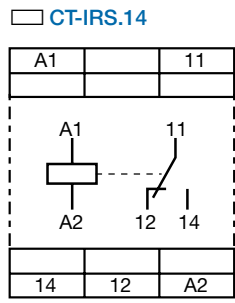

A1-A2 Supply: 110-240 V AC
11-12/14 1. c/o contact

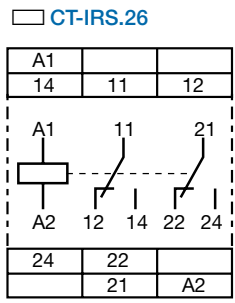

A1-A2 Supply: 24 AC/DC
11-12/14 1. c/o contact
21-22/24 2. c/o contact

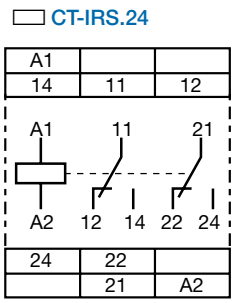

A1-A2 Supply: 110-240 V AC
11-12/14 1. c/o contact
21-22/24 2. c/o contact

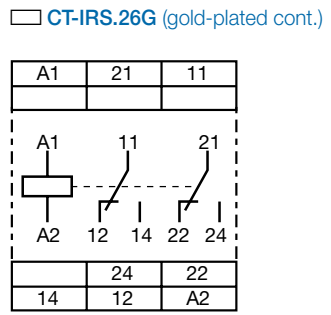

A1-A2 Supply: 24 AC/DC
11-12/14 1. c/o contact
21-22/24 2. c/o contact

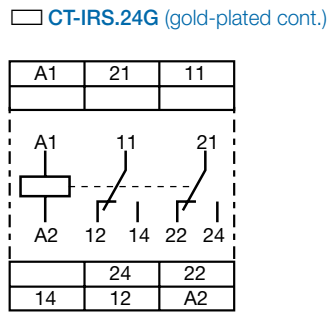

A1-A2 Supply: 110-240 V AC
11-12/14 1. c/o contact
21-22/24 2. c/o contact

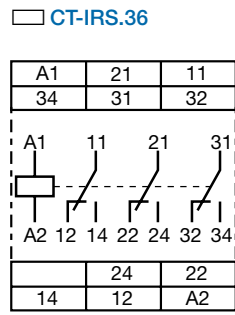

A1-A2 Supply: 24 V AC/DC
11-12/14 1. c/o contact
21-22/24 2. c/o contact
31-32/34 3. c/o contact

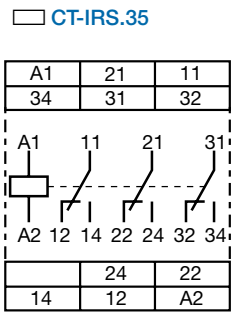

A1-A2 Supply: 220-240 V AC
11-12/14 1. c/o contact
21-22/24 2. c/o contact
31-32/34 3. c/o contact

Data at $T_a = 25\text{ °C}$ and rated values, unless otherwise indicated

		CT-S
Input circuit - Supply circuit		
Rated control supply voltage U_s	CT-xxx.x1	24-240 V AC/DC
	CT-xxx.x2	24-48 V DC, 24-240 V AC
	CT-xxx.x3	380-440 V AC
	CT-xxx.x4	110-240 V AC
	CT-xxx.x5	220-240 V AC
	CT-xxx.x6	24 V AC/DC
	CT-xxx.x7	100-127 V AC or 110 V DC
	CT-xxx.x8	200-240V AC/DC
Rated control supply voltage U_s tolerance		-15...+10 %
Rated frequency		DC or 50/60 Hz
Frequency range AC		47-63 Hz
Typical current / power consumption		depending on device, see data sheet
Power failure buffering time	24 V DC 230/400 V AC	min. 15 ms min. 20 ms
Input circuit - Control circuit		
Kind of triggering	CT-MVS, CT-MXS, CT-APS	voltage-related triggering
Control input, Control function	A1-Y1	start timing external (CT-MVS, CT-MXS, CT-APS)
Parallel load / polarized		yes / no
Maximum cable length to the control input		50 m - 100 pF/m
Minimum control pulse length		20 ms
Control voltage potential		see rated control supply voltage
Current consumption of the control input	24 V DC 230 V AC 400 V AC	1.2 mA 8 mA 6 mA
Kind of triggering	CT-MFS, CT-MBS, CT-AHS	volt-free triggering
Control input, Control function	Y1-Z2 X1-Z2	start timing external (CT-MFS, CT-MBS, CT-AHS) pause timing / accumulative functions (CT-MFS)
Maximum switching current in the control circuit		1 mA
Maximum cable length to the control input		50 m - 100 pF/m
Minimum control pulse length		20 ms
No-load voltage at the control inputs		10-40 V DC
Remote potentiometer		
Remote potentiometer connections, Resistance value	Z1-Z2 Z3-Z2	50 k Ω (CT-MFS, CT-MBS, CT-MVS.21, CT-MXS) 50 k Ω (CT-MXS)
Maximum cable length to remote potentiometer		2 x 25 m, shielded with 100 pF/m
Shield connection		Z2
Timing circuit		
Time ranges	10 time ranges 0.05 s - 300 h 7 time ranges 0.05 s - 10 min (CT-SDS, CT-ARS)	1.) 0.05-1 s 2.) 0.15-3 s 3.) 0.5-10 s 4.) 1.5-30 s 5.) 5-100 s 6.) 15-300 s 7.) 1.5-30 min 8.) 15-300 min 9.) 1.5-30 h 10.) 15-300 h 1.) 0.05-1 s 2.) 0.15-3 s 3.) 0.5-10 s 4.) 1.5-30 s 5.) 5-100 s 6.) 15-300 s 7.) 0.5-10 min
Recovery time	24-240 V AC/DC 24-48 V DC, 24-240 V AC 380-440 V AC	<50 ms < 80 ms < 60 ms
Accuracy within the rated control supply voltage tolerance		$\Delta t < 0.004\%$ / V
Accuracy within the temperature range		$\Delta t < 0.03\%$ / °C
Repeat accuracy (constant parameters)		$\Delta t < 0.2\%$
Star-delta transition time		fixed 50 ms (CT-SDS, CT-MBS, CT-MFS, CT-MVS.2x)
Star-delta transition time tolerance		± 2 ms
Minimum energizing time		100 ms (CT-ARS)
Formatting time ¹⁾		5 min (CT-ARS)

¹⁾ prior to first commissioning and after a six-month stop in operation

CT-S range

Technical data

Indication of operational states

Control supply voltage / timing	U/T: green LED	: control supply voltage applied / : timing
Control supply voltage	U: green LED	: control supply voltage applied
Relay state	R, R1, R2: yellow LED	: output relay energized (R, R1, R2)

Output circuit

Kind of output	15-16/18	relay, 1 c/o contact
	15-16/18; 25-26/28	relay, 2 c/o contacts
	15-16/18; 25(21)-26(22)/28(24)	relay, 2 c/o contacts, 2nd c/o contact selectable as inst. contact
	17-18; 17-28	relay, 2 n/o contacts (CT-SDS)
Contact material		Cd-free, on request
Rated operational voltage U_g	IEC/EN 60947-1	250 V
Minimum switching voltage / minimum switching current		12 V / 10 mA (CT-IRS.2xG: 10 mV / 10 μ A)
Maximum switching voltage / maximum switching current		see load limit curves (CT-IRS.2xG: 10 V / 200 mA)
Rated operational current I_g (IEC/EN 60947-5-1)	AC12 (resistive) at 230 V	4 A
	AC15 (inductive) at 230 V	3 A
	AC15 (inductive) at 230 V	4 A
	DC13 (inductive) at 24 V	2 A (CT-ARS; 1.5 A)
AC rating (UL 508)	Utilization category (Control Circuit Rating Code)	B 300
	max. rated operational voltage	300 V AC
	Maximum continuous thermal current at B300	5 A
	max. making/breaking apparent power at B300	3600 VA / 360 VA
Mechanical lifetime		30×10^6 switching cycles
Electrical lifetime	at AC12, 230 V, 4 A	0.1×10^6 switching cycles
Max. fuse rating to achieve short-circuit protection (IEC/EN 60947-5-1)	n/c contact	6 A fast-acting
	n/o contact	10 A fast-acting

General data ²⁾

MTBF		on request
Duty time		100%
Dimensions (W x H x D)	product dimensions	22.5 x 85.6 x 103.7 mm (0.89 x 3.37 x 4.08 in)
	packaging dimensions	97 x 109 x 30 mm (3.82 x 4.29 x 1.18 in)
Weight		depending on device, see ordering details
Mounting		DIN rail (IEC/EN 60715), snap-on mounting without any tool
Mounting position		any
Minimum distance to other units	vertical / horizontal	not necessary / not necessary
Material of housing		UL 94 V-0
Degree of protection	housing / terminals	IP50 / IP20

Electrical connection ²⁾

	Screw connection technology	Easy Connect Technology (Push-in)
Wire size	fine-strand with(out) wire end ferrule	1 x 0.5-2.5 mm ² (1 x 20-14 AWG)
		2 x 0.5-1.5 mm ² (2 x 20-16 AWG)
	rigid	1 x 0.5-4 mm ² (1 x 20-12 AWG)
		2 x 0.5-2.5 mm ² (2 x 20-14 AWG)
Stripping length	8 mm (0.32 in)	
Tightening torque	0.6-0.8 Nm (5.31-7.08 lb.in)	-

²⁾ Data for all references 1SVR 730 xxx xxx and 1SVR 740 xxx xxx. For devices with 1SVR 430 xxx xxx and 1SVR 630 xxx xxx please refer to the data sheet.

CT-S range

Technical data

Environmental data

Ambient temperature ranges	operation / storage	-25...+60 °C / -40...+85 °C, -40...+60 °C / -40...+85 °C (CT-MVS.21, CT-MFS.21, CT-ERS.21, CT-APS.21)
Damp heat (cyclic) (IEC/EN 60068-2-30)		6 x 24 h cycle, 55 °C, 95 % RH
Vibration, sinusoidal (IEC/EN 60068-2-6)	functioning	40 m/s ² , 10-58/60-150 Hz
Vibration, seismic (IEC/EN 60068-3-3)	resistance	60 m/s ² , 10-58/60-150 Hz, 20 cycles
	functioning	20 m/s ²
Shock, half-sine (IEC/EN 60068-2-27)	functioning	100 m/s ² , 11 ms, 3 shocks/direction
	resistance	300 m/s ² , 11 ms, 3 shocks/direction

6

Isolation data

Rated insulation voltage U_i	input circuit / output circuit	500 V
Rated impulse withstand voltage U_{imp} between all isolated circuits	VDE 0110, IEC/EN 60664	4 kV; 1.2/50 μ s
Power-frequency withstand voltage test between all isolated circuits (test voltage)	routine test	2.0 kV, 50Hz, 1 s
	type test	2.5 kV, 50 Hz, 1 min
Basic insulation (IEC/EN 61140)	input circuit / output circuit	500 V
Protective separation (IEC/EN 61140; IEC/EN 50178; VDE 0106 part 101 and part 101/ A1)	input circuit / output circuit	250 V
Pollution degree (IEC/EN 60664-1, VDE 0110)		3
Overtoltage category (IEC/EN 60664-1, VDE 110)		III

Standards

Product standard	IEC 61812-1, EN 61812-1 + A11, DIN VDE 0435 part 2021
Low Voltage Directive	2006/95/EC
EMC Directive	2004/108/EC
RoHS Directive	2002/95/EC

Electromagnetic compatibility

Interference immunity to		IEC/EN 61000-6-1, IEC/EN 61000-6-2
electronic discharge	IEC/EN 61000-6-2	Level 3 6 kV / 8 kV
radiated, radio-frequency electromagnetic field	IEC/EN 61000-6-3	Level 3 10 V/m (1 GHz) 3 V/m (2 GHz) 1 V/m (2.7 GHz)
electrical fast transient/burst surge	IEC/EN 61000-6-4	Level 3 2 kV / 5 kHz
	IEC/EN 61000-6-5	Level 4 2 kV A1-A2
conducted disturbances, induced by radio-frequency fields	IEC/EN 61000-6-6	Level 3 10 V
		Level 3
Interference emissions		IEC/EN 61000-6-3, IEC/EN 61000-6-4
high-frequency radiated	IEC/CISPR 22, EN 55022	Class B
high-frequency conducted	IEC/CISPR 22, EN 55022	Class B

CT-S range Technical diagrams

Technical diagrams

Load limit curves

AC load (resistive)

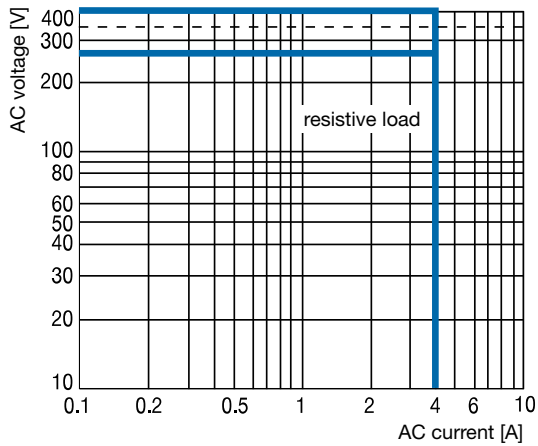

DC load (resistive)

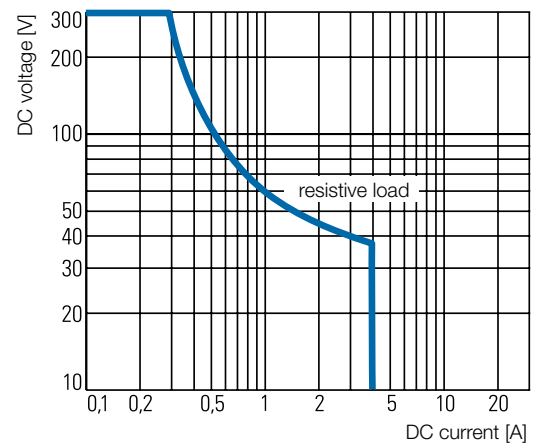

Derating factor F for inductive AC load

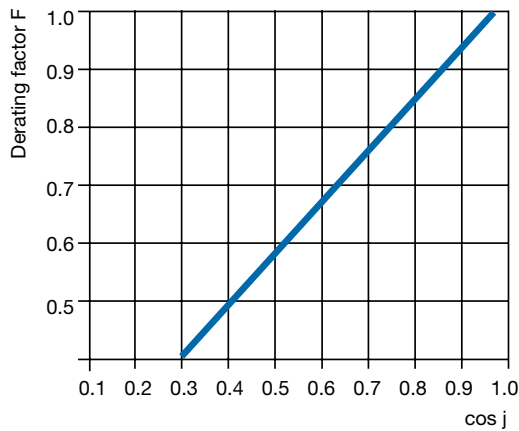

Contact lifetime

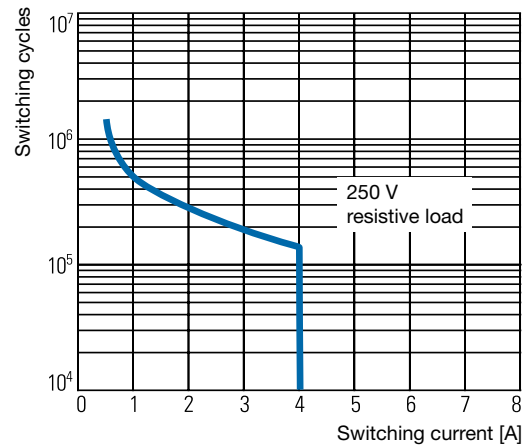

CT-S range

Wiring notes

Approximate dimensions

Wiring notes

Control inputs (volt-free triggering)

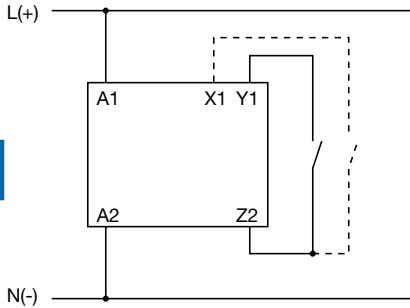

Triggering of the control inputs (volt-free) with a proximity switch (3 wire)

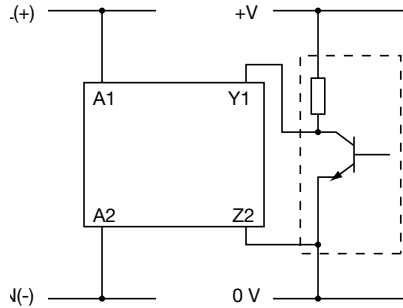

Control inputs (voltage-related triggering)

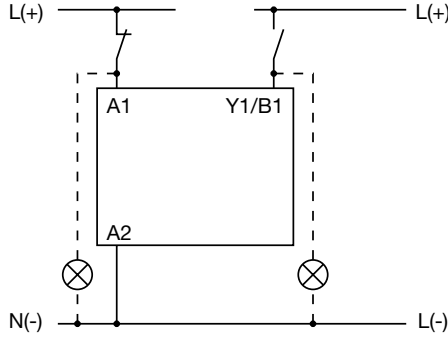
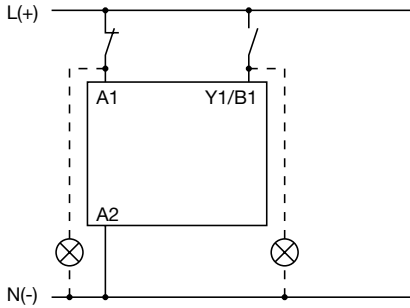

The control input **Y1/B1** is triggered with electric potential against **A2**. It is possible to use the control supply voltage from terminal **A1** or any other voltage within the rated control supply voltage range.

Remote potentiometer

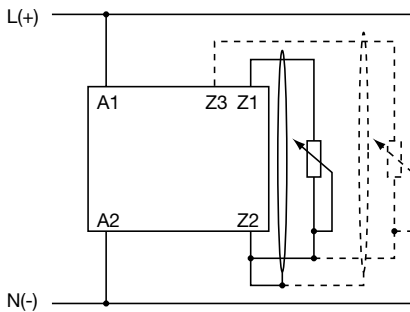

Dimensional drawing

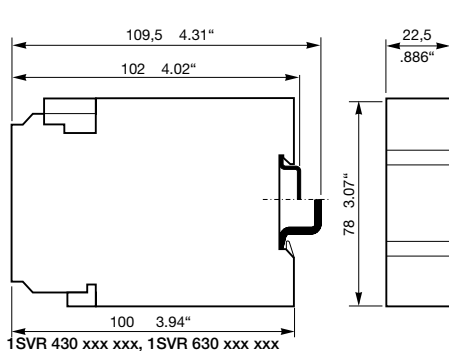

Dimensions in mm and inches

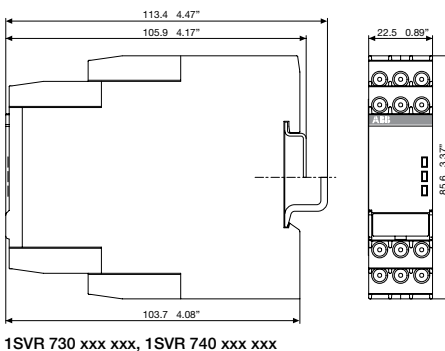

CM-E Range Measuring & monitoring relays

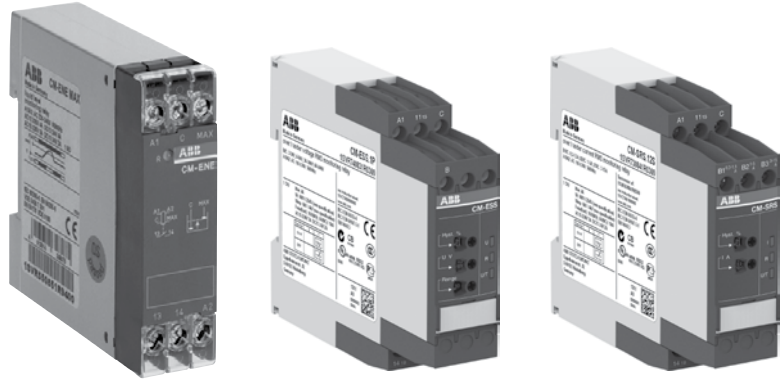

Measuring and monitoring relays

Benefits and advantages.

Benefits CM-E range



6

- Only 22.5 mm wide housing
- Output contacts: 1 c/o contact or 1 n/o contact
- One supply voltage range
- One monitoring function
- Cost-efficient solution for OEM applications
- Preset monitoring ranges

Combination screws ①

Easy tightening and release of the connecting screws with pozidrive, pan- or crosshead screwdriver.

Safety ②

The "real distance" is hidden.
The clearance and the creepage distances of our products exceed international standards and substantially increase the safety of our products.

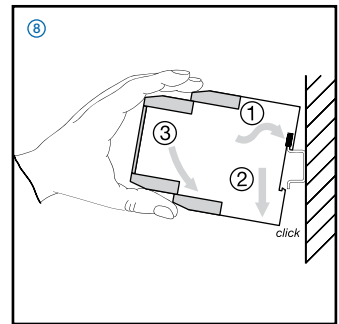
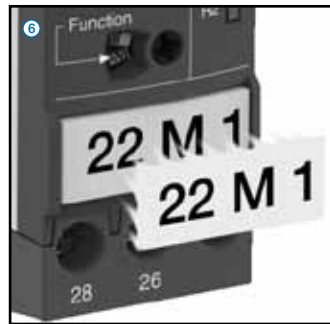
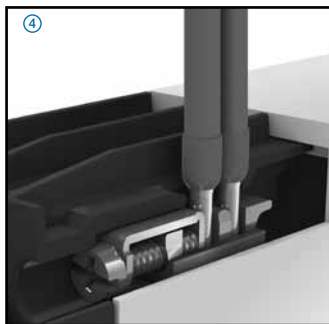
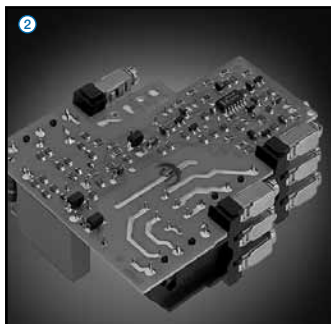
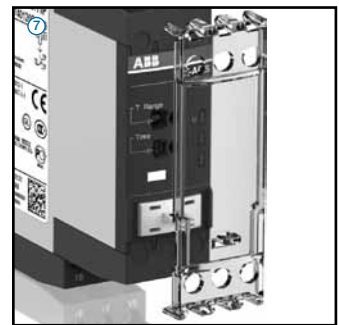
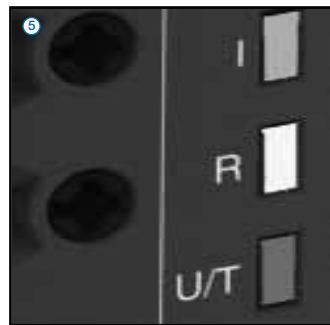
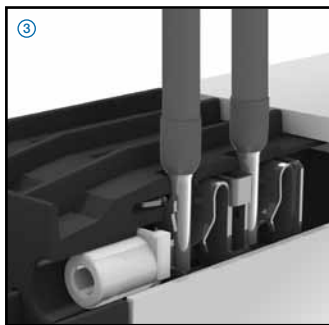

CM-S range: Universal and multifunctional



- Only 22.5 mm wide housing
- Output contacts: 1 or 2 c/o (SPDT) contacts
- One supply voltage range or supplied by measuring circuit
- Setting and operation via front-face operating controls
- Adjustment of threshold values and switching hysteresis via direct reading scale
- Integrated and snap-fitted front-face marker
- Snap-on housing: The relays can be placed on a DIN rail tool-free - just snap it on or remove it tool-free
- Sealable transparent cover (accessory)

Measuring and monitoring relays

Benefits and advantages.

CM-N range: Multifunctional



- 45 mm wide housing
- Output contacts: 2 c/o (SPDT) contacts
- Continuous voltage range (24-240 V AC/DC) or single-supply
- Setting and operation via front-face operating controls
- Adjustment of threshold values and switching hysteresis via direct reading scale
- Adjustable time delays
- Integrated and snap-fitted front-face marker label
- Sealable transparent cover (accessory)

ABB's measuring and monitoring relays in a new housing

Benefits at a glance

Double-chamber cage connection terminals

Easy conversions:

The old range of measuring and monitoring relays is replaced by an identical range of relays with Double-chamber cage connection terminals.

The ordering number just changed in one digit:

1SVRx3 ... changed to 1SVR73...

1SVRx5 ... changed to 1SVR75...

and for the type designator we are using one more specifier:

CM-xxS changed to CM-xxS.S

CM-xxN changed to CM-xxN.S

The new range is identically replacing the old range.

Ratings:

Double-chamber cage connection terminals provide connection of wires up to 1 x 0.5-4 mm² (1 x 20-12 AWG) or 2 x 0.5-2.5 mm² (2 x 20-14 AWG) rigid or 1 x 0.5-2.5 mm² (1 x 20-14 AWG) / 2 x 0.5-1.5 mm² (2 x 20-16 AWG), rigid or fine-strand, with or without wire end ferrules. Potential distribution does not require additional terminals.

Extended features

Flammability:

The plastic housing material used meets the requirements for the highest flammability class. (UL94 V-O rated)

Look and feel:

The new housing fits perfectly with ABB's control products offer.

Easy Connect Technology & Double-chamber cage connection terminals

Benefits new CM-S range housing

Easy Connect Technology ③

Tool-free wiring for excellent vibration resistance. Push-in terminals provide connection of wires up to 2 x 0.5 - 1.5 mm², rigid or fine stranded with or without wire end ferrules.

Double-chamber cage connection terminals ④

Double-chamber cage connection terminals provide connection of wires up to 2 x 0.5-2.5 mm² (2 x 20-14 AWG) rigid or fine-strand, with or without wire end ferrules. Potential distribution does not require additional terminals.

Snap-On housing ⑧

Tool-free DIN rail installation and deinstallation of the monitoring relay with Snap-On housing.

LED's for status indication ⑤

All actual operational states are displayed by front-face LED's, thus simplifying commissioning and troubleshooting.

Integrated marker label ⑥

Integrated marker labels allow the product to be marked quickly and simply. No additional marker labels are required.

Sealable transparent cover ⑦

Protection against unauthorized changes of time and threshold values. Available as an accessory.

Easy Connect Technology

New options:

Additionally to the existing well established screw connections a new innovative connection technology can be offered: Easy Connect Technology with push-in terminals.

Tool-free Wiring:

The push-in terminals can be wired with rigid or fine stranded wires with wire end ferrules totally tool-free. The connection direction is exactly the same as the screw version.

Higher utility class:

The Easy Connect Technology provides excellent vibration resistance with gas tight push-in terminals – the right solution for harsh environment.

Ratings:

Push-in terminals provide connection of wires up to 2 x 1.5mm² (2 x 20-16 AWG), rigid or fine stranded with or without wire end ferrules.

Measuring and monitoring relays

Monitoring features and application ranges

6

Single-phase current and voltage monitoring

- Over- or undercurrent monitoring CM-SRS and CM-SRS.M
- Over- and undercurrent monitoring CM-SFS
- Over- or undervoltage monitoring CM-ESS and CM-ESS.M
- Over- and undervoltage monitoring CM-EFS

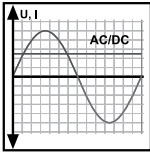

Current monitoring

- Monitoring of motor current consumption
- Monitoring of lighting installations and heating circuits
- Monitoring of hoisting gear and transportation equipment overload
- Monitoring of locking devices, electromechanical brake gear and locked rotor

Voltage monitoring

- Speed monitoring of DC motors
- Monitoring of battery voltages and other supply networks
- Monitoring of upper and lower voltage threshold values

Insulation monitoring

- CM-IWS.2 for electrically isolated AC systems, and CM-IWS.1 & CM-IWN 1 for electrically isolated AC, DC and mixed AC/DC systems.
- CM-IWN.5 for solar applications $\leq 1000 \mu\text{F}$

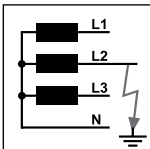

Insulation monitoring

- Monitoring of electrically isolated supply mains for insulation resistance failure
- Detection of initial faults
- Protection against earth faults

Thermistor motor protection

CM-MSE, CM-MSS and CM-MSN provide full protection of motors with integrated PTC resistor sensors.

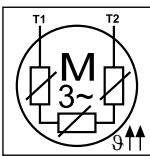

Thermistor motor protection

- Protection of motors against thermal overload, e. g. caused by insufficient cooling, heavy load starting conditions, undersized motors, etc.

Three-phase monitoring

- Phase loss CM-PBE
- Over- and undervoltage CM-PVE
- Phase sequence and phase loss CM-PFE and CM-PFS
- Phase sequence and phase loss, over- and undervoltage CM-PSS.xx and CM-PVS.xx
- Phase sequence and phase loss, unbalance CM-PAS.xx
- Phase sequence and phase loss, unbalance, over- and undervoltage CM-MPS.xx and CM-MPN.xx
- Over- and undervoltage, over- and underfrequency CM-UFS.x

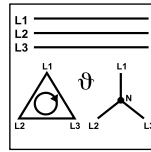

Three-phase voltage monitoring

- Voltage monitoring of mobile three-phase equipment
- Protection of personnel and installations against phase reversal
- Monitoring of the supply voltage to machines and installations
- Protection of equipment against damage caused by unstable supply voltage
- Switching to emergency or auxiliary supply
- Protection of motors against damage caused by unbalanced phase voltages and phase loss
- Automatic connection & disconnection of decentralised power stations to the grid

Motor load monitoring

CM-LWN monitoring relays load states of single- and three-phase asynchronous motors.

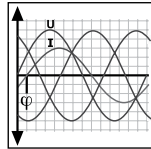

Motor load monitoring

- Detection of V-belt breaking
- Motor protection against overload
- Monitoring of filters for clogging
- Protection of pumps against dry running
- Detection of high pressure in conduit systems
- Monitoring for dulling blades in sawing and cutting machines

Liquid level monitoring

CM-ENE, CM-ENS and CM-ENN for control and regulation of liquid levels and ratios of mixtures of conductive fluids.

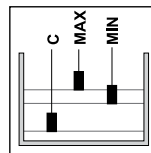

Liquid level monitoring and control

- Protection of pumps against dry running
- Protection against container overflow
- Control of liquid levels
- Detection of leaks
- Control of mixing ratios

Measuring and monitoring relays

Monitoring features and application ranges

Contact protection, sensor evaluation

The CM-KRN protects sensitive control contacts from excessive loads and can store switch positions. The CM-SIS supplies and evaluates NPN and PNP sensors.

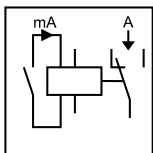

Contact protection / sensor evaluation

- Storage of the switching states of bouncing contacts
- Amplification of the switch state information of sensitive contacts
- Supply and evaluation of NPN or PNP sensors

Cycle monitoring

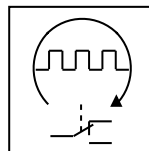

Cycle monitoring

- External monitoring of the correct function of programmable logic controllers (plc) and industrial pcs (ipc)

Temperature monitoring

Acquisition, messaging and regulation of temperatures of solid, liquid and gaseous media in processes and machines via PT100, PT1000, KTY83, KTY 84 or NTC sensors with C510, C511, C512, C513.

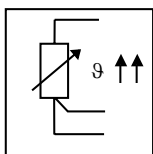

Temperature monitoring

- Motor and system protection
- Control panel temperature monitoring
- Frost monitoring
- Temperature limits for process variables, e.g. in the packing or electroplating industry
- Control of systems and machines like heating, air-conditioning and ventilation systems, solar collectors, heat pumps or hot water supply systems
- Monitoring of servomotors with KTY sensors
- Bearing and gear oil monitoring
- Coolant monitoring

Measuring and monitoring relays

Monitoring features and application ranges

6

		Current and voltage monitoring, single-phase							Three-phase monitoring													
		CM-SRS.1x	CM-SRS.2x	CM-SRS.M	CM-SFS.2	CM-ESS.2x	CM-ESS.M	CM-EFS.2	CM-PBE	CM-PVE	CM-PFE	CM-PFS	CM-PSS.x1	CM-PVS.x1	CM-PAS.x1	CM-MPS.x1	CM-MPS.x3	CM-MPN.52	CM-MPN.62	CM-MPN.72	CM-UFS.2	
Approvals																						
	UL 508, CAN/CSA C22.2 No.14	■	■	■	■	■	■	■	■	■	■	■	■	■	■	■	■	■	■	■	■	■
	GL	□	□	□	□	□	□	□	□	□	□	□	□	□	□	□	□	□	□	□	□	□
	GOST	■	■	■	■	■	■	■	■	■	■	■	■	■	■	■	■	■	■	■	■	■
	CB scheme	■	■	■	■	■	■	■	■	■	■	■	■	■	■	■	■	■	■	■	■	■
	CCC	■	■	■	■	■	■	■	■	■	■	■	■	■	■	■	■	■	■	■	■	■
	RMRS	■	■	■	■	■	■	■	■	■	■	■	■	■	■	■	■	■	■	■	■	■
	ENEL DK 5940 Ed. 2.2																					■
Marks																						
	CE	■	■	■	■	■	■	■	■	■	■	■	■	■	■	■	■	■	■	■	■	■
	C-Tick	■	■	■	■	■	■	■	■	■	■	■	■	■	■	■	■	■	■	■	■	■

		Insulation monitoring relays for un-grounded supply mains					Motor load monitoring			Temperature monitoring			Contact protection, sensor interface					
		CM-IWS.2	CM-IWS.1	CM-IWN.1	CM-IWN.5	CM-IWN	CM-LWN			CM-TCS	C512	C513	CM-KRN	CM-SIS				
Approvals																		
	UL 508, CAN/CSA C22.2 No.14	■	■	■	■	■	■				■	■	■	■	■			
	GL	■	■	■		■	■						■	■				
	GOST	■	■	■	■	■	■				■		■	■				
	CB scheme	■	■	■	□	■	■				■		■	■				
	CCC	■	■	■	□	■	■				■		■	■				
	RMRS						■						■	■				
Marks																		
	CE	■	■	■	■	■	■				■	■	■	■				
	C-Tick	■	■	■	■	■	■				■		■	■				

		Cycle monitoring		Thermistor motor protection								Liquid level monitoring						
		CM-WDS		CM-MSE	CM-MSS (1)	CM-MSS (2)	CM-MSS (3)	CM-MSS (4)	CM-MSS (5)	CM-MSS (6)	CM-MSS (7)	CM-MSN	CM-ENE MIN	CM-ENE MAX	CM-ENS	CM-ENS UP/...	CM-ENN	CM-ENN UP/...
Approvals																		
	UL 508, CAN/CSA C22.2 No.14	■		■	■	■	■	■	■	■	■	■	■	■	■	■	■	■
	GL			■	■	■	■	■	■	■	■	■	■	■	■	■	■	■
	GOST	■		■	■	■	■	■	■	■	■	■	■	■	■	■	■	■
	II (2) G D, PTB 02 ATEX 3080																	
	CB scheme			■	■	■	■	■	■	■	■	■	■	■	■	■	■	■
	CCC			■	■	■	■	■	■	■	■	■	■	■	■	■	■	■
	RMRS	■		■	■	■	■	■	■	■	■	■	■	■	■	■	■	■
Marks																		
	CE	■		■	■	■	■	■	■	■	■	■	■	■	■	■	■	■
	C-Tick	■		■	■	■	■	■	■	■	■	■	■	■	■	■	■	■

¹⁾ Versions with safety isolation without approval

CM-E Range Current & voltage monitoring relays



Current & voltage monitoring relays
Single phase



Current and voltage monitoring relays, single phase

Benefits and advantages

6



Characteristics current monitoring relays

- Monitoring of DC and AC currents: 3 mA to 15 A ¹⁾
- TRMS measuring principle
- One device includes 3 measuring ranges
- Over- and undercurrent monitoring¹⁾
- ON or OFF delay configurable¹⁾
- Open- or closed circuit principle configurable¹⁾
- Latching function configurable¹⁾
- Thresholds for >I and/or <I adjustable¹⁾
- Fixed hysteresis of 5 %¹⁾
- Start-up delay T_v adjustable 0; 0.1 - 30 s¹⁾
- Tripping delay T_v adjustable 0; 0.1 - 30 s¹⁾
- 1 x 2 c/o contacts (common signal) or 2 x 1 c/o contact (separate signals for >I and <I) configurable¹⁾
- 22.5 mm width
- 3 LED's for status indication

¹⁾ depending on device

Current monitoring, single-phase

The ABB current monitoring relays CM-SRS.xx reliably monitor the occurrence of currents that exceed or fall below the selected threshold value. The functions overcurrent or undercurrent monitoring can be pre-selected. Single- and multifunction devices for the monitoring of direct or alternating currents from 3 mA to 15 A are available.

Current window monitoring (I_{min} , I_{max})

The window monitoring relay CM-SFS.2x is available if the application requires the simultaneous monitoring of over- and undercurrents.

Characteristics voltage monitoring relays

- Monitoring of DC and AC voltages from 3 - 600 V
- TRMS measuring principle
- One device includes 4 measuring ranges: 3 - 30 V; 6 - 60 V; 30 - 300 V; 60 - 600 V
- Over- and undervoltage monitoring¹⁾
- ON or OFF delay configurable¹⁾
- Open- or closed circuit principle configurable¹⁾
- Latching function configurable¹⁾
- Threshold values for >U and/or <U adjustable¹⁾
- Fixed hysteresis of 5 %¹⁾
- Start-up delay T_v adjustable 0; 0.1 - 30 s¹⁾
- Tripping delay T_v adjustable 0; 0.1 - 30 s¹⁾
- 1 x 2 c/o contacts (common signal) or 2 x 1 c/o contact (separate signals for >U and <U) configurable¹⁾
- 22.5 mm width
- 3 LED's for status indication

Voltage monitoring, single-phase

The ABB voltage monitoring relays CM-SRS.xx are used to monitor direct and alternating voltages within a range of 3-600 V. Over- or undervoltage detection can be preselected.

Voltage window monitoring (U_{min} , U_{max})

For the simultaneous detection of over- and undervoltages, the window monitoring relay CM-EFS.2 can be used.

Current and voltage monitoring relays, single phase

Selection and conversion

6

Reference code	Catalog number	Predecessor
CM-ESS.1S	1SVR730831R0300	1SVR430831R0300
CM-ESS.1P	1SVR740831R0300	
CM-ESS.1S	1SVR730831R0300	1SVR430831R0300
CM-ESS.1P	1SVR740831R0300	
CM-ESS.1S	1SVR730831R1300	1SVR430831R1300
CM-ESS.1P	1SVR740831R1300	
CM-ESS.2S	1SVR730830R0400	1SVR430830R0400
CM-ESS.2P	1SVR740830R0400	
CM-ESS.2S	1SVR730831R0400	1SVR430831R0400
CM-ESS.2P	1SVR740831R0400	
CM-ESS.2S	1SVR730831R1400	1SVR430831R1400
CM-ESS.2P	1SVR740831R1400	
CM-ESS.MS	1SVR730830R0500	1SVR430830R0500
CM-ESS.MP	1SVR740830R0500	
CM-EFS.2S	1SVR730750R0400	1SVR430750R0400
CM-EFS.2P	1SVR740750R0400	

Rated control supply voltage U _s	CM-ESS.1S	CM-ESS.1P	CM-ESS.1S	CM-ESS.1P	CM-ESS.1S	CM-ESS.1P	CM-ESS.2S	CM-ESS.2P	CM-ESS.2S	CM-ESS.2P	CM-ESS.2S	CM-ESS.2P	CM-ESS.MS	CM-ESS.MP	CM-EFS.2S	CM-EFS.2P
24 - 240 V AC/DC	■	■					■	■					■	■	■	■
110 - 130 V AC			■	■					■	■						
220 - 240 V AC					■	■					■	■				

Measuring ranges AC/DC	CM-ESS.1S	CM-ESS.1P	CM-ESS.1S	CM-ESS.1P	CM-ESS.1S	CM-ESS.1P	CM-ESS.2S	CM-ESS.2P	CM-ESS.2S	CM-ESS.2P	CM-ESS.2S	CM-ESS.2P	CM-ESS.MS	CM-ESS.MP	CM-EFS.2S	CM-EFS.2P
3 - 30 V	■	■	■	■	■	■	■	■	■	■	■	■	■	■	■	■
6 - 60 V	■	■	■	■	■	■	■	■	■	■	■	■	■	■	■	■
30 - 300 V	■	■	■	■	■	■	■	■	■	■	■	■	■	■	■	■
60 - 600 V	■	■	■	■	■	■	■	■	■	■	■	■	■	■	■	■

Monitoring function	CM-ESS.1S	CM-ESS.1P	CM-ESS.1S	CM-ESS.1P	CM-ESS.1S	CM-ESS.1P	CM-ESS.2S	CM-ESS.2P	CM-ESS.2S	CM-ESS.2P	CM-ESS.2S	CM-ESS.2P	CM-ESS.MS	CM-ESS.MP	CM-EFS.2S	CM-EFS.2P
Over- or undervoltage	■	■	■	■	■	■	■	■	■	■	■	■	■	■		
Windows voltage monitoring															■	■
Latching													sel	sel	sel	sel
Open circuit or closed circuit principle													sel	sel	sel	sel

Timing functions for tripping delay	CM-ESS.1S	CM-ESS.1P	CM-ESS.1S	CM-ESS.1P	CM-ESS.1S	CM-ESS.1P	CM-ESS.2S	CM-ESS.2P	CM-ESS.2S	CM-ESS.2P	CM-ESS.2S	CM-ESS.2P	CM-ESS.MS	CM-ESS.MP	CM-EFS.2S	CM-EFS.2P
ON delay, 0 or 0,1 - 30 s							adj	adj	adj	adj	adj	adj	adj	adj		
ON or OFF delay															sel	sel

Output	CM-ESS.1S	CM-ESS.1P	CM-ESS.1S	CM-ESS.1P	CM-ESS.1S	CM-ESS.1P	CM-ESS.2S	CM-ESS.2P	CM-ESS.2S	CM-ESS.2P	CM-ESS.2S	CM-ESS.2P	CM-ESS.MS	CM-ESS.MP	CM-EFS.2S	CM-EFS.2P
c/o contact	1	1	1	1	1	1	2	2	2	2	2	2	2	2	2	2

Connection type	CM-ESS.1S	CM-ESS.1P	CM-ESS.1S	CM-ESS.1P	CM-ESS.1S	CM-ESS.1P	CM-ESS.2S	CM-ESS.2P	CM-ESS.2S	CM-ESS.2P	CM-ESS.2S	CM-ESS.2P	CM-ESS.MS	CM-ESS.MP	CM-EFS.2S	CM-EFS.2P
Easy Connect Technology		■		■		■		■		■		■		■		■
Double-chamber cage connection terminals	■		■		■		■		■		■		■		■	

Current and voltage monitoring relays, single phase

Ordering details Current monitors

Description

Single phase voltage and current monitors protect sensitive equipment and control systems against undervoltage, undercurrent events, overvoltage or overcurrent events. Different units with adjustable or fixed threshold values (trip points) are available.



CM-SRS.22S



CM-SFS.22P

Ordering details

Rated control supply voltage	Tripping delay T_v	Measuring range	Reference code	Catalog number	Weight (1 pce) kg (lb)
24-240 V AC/DC	without	3-30 mA 10-100 mA 0.1-1 A	CM-SRS.11S	1SVR730840R0200	0.145 (0.320)
110-130 V AC				1SVR730841R0200	0.161 (0.355)
220-240 V AC				1SVR730841R1200	0.161 (0.355)
24-240 V AC/DC			CM-SRS.11P	1SVR740840R0200	0.137 (0.302)
110-130 V AC				1SVR740841R0200	0.153 (0.337)
220-240 V AC				1SVR740841R1200	0.153 (0.337)
24-240 V AC/DC	without	0.3-1.5 A 1-5 A 3-15 A	CM-SRS.12S	1SVR730840R0300	0.137 (0.302)
110-130 V AC				1SVR730841R0300	0.168 (0.370)
220-240 V AC				1SVR730841R1300	0.168 (0.370)
24-240 V AC/DC	adjustable 0 or 0.1-30 s	3-30 mA 10-100 mA 0.1-1 A	CM-SRS.21S	1SVR730840R0400	0.152 (0.335)
110-130 V AC				1SVR730841R0400	0.179 (0.395)
220-240 V AC				1SVR730841R1400	0.179 (0.395)
24-240 V AC/DC			CM-SRS.21P	1SVR740840R0400	0.141 (0.311)
110-130 V AC				1SVR740841R0400	0.168 (0.370)
220-240 V AC				1SVR740841R1400	0.168 (0.370)
24-240 V AC/DC	adjustable 0 or 0.1-30 s	0.3-1.5 A 1-5 A 3-15 A	CM-SRS.22S	1SVR730840R0500	0.144 (0.399)
110-130 V AC				1SVR730841R0500	0.181 (0.399)
220-240 V AC				1SVR730841R1500	0.181 (0.399)
24-240 V AC/DC	adjustable 0 or 0.1-30 s	3-30 mA 10-100 mA 0.1-1 A	CM-SRS.M1S	1SVR730840R0600	0.153 (0.337)
			CM-SRS.M1P	1SVR740840R0600	0.142 (0.313)
24-240 V AC/DC	adjustable 0 or 0.1-30 s	0.3-1.5 A 1-5 A 3-15 A	CM-SRS.M2S	1SVR730840R0700	0.155 (0.342)
24-240 V AC/DC	adjustable 0 or 0.1-30 s	3-30 mA 10-100 mA 0.1-1 A	CM-SFS.21S	1SVR730760R0400	0.150 (0.331)
			CM-SFS.21P	1SVR740760R0400	0.139 (0.306)
24-240 V AC/DC	adjustable 0 or 0.1-30 s	0.3-1.5 A 1-5 A 3-15 A	CM-SFS.22S	1SVR730760R0500	0.158 (0.348)

Current and voltage monitoring relays, single phase

Ordering details, Voltage monitors



CM-ESS.MP



CM-EFS.2

Ordering details

Rated control supply voltage	Tripping delay TV	Measuring range	Reference code	Catalog number	Weight (1 pce) kg (lb)
24-240 V AC/DC	without	3-30 V 6-60 V 30-300 V 60-600 V	CM-ESS.1S	1SVR730830R0300	0.135 (0.298)
110-130 V AC				1SVR730831R0300	0.164 (0.362)
220-240 V AC				1SVR730831R1300	0.164 (0.362)
24-240 V AC/DC			CM-ESS.1P	1SVR740830R0300	0.126 (0.278)
110-130 V AC				1SVR740831R0300	0.155 (0.342)
220-240 V AC				1SVR740831R1300	0.155 (0.342)
24-240 V AC/DC	adjustable 0 or 0.1-30 s	3-30 V 6-60 V 30-300 V 60-600 V	CM-ESS.2S	1SVR730830R0400	0.153 (0.337)
110-130 V AC				1SVR730831R0400	0.181 (0.399)
220-240 V AC				1SVR730831R1400	0.181 (0.399)
24-240 V AC/DC			CM-ESS.2P	1SVR740830R0400	0.142 (0.313)
110-130 V AC				1SVR740831R0400	0.170 (0.375)
220-240 V AC				1SVR740831R1400	0.170 (0.375)
24-240 V AC/DC	adjustable 0 or 0.1-30 s	3-30 V 6-60 V 30-300 V 60-600 V	CM-ESS.MS	1SVR730830R0500	0.154 (0.340)
			CM-ESS.MP	1SVR740830R0500	0.143 (0.320)
24-240 V AC/DC	adjustable 0 or 0.1-30 s	3-30 V 6-60 V 30-300 V 60-600 V	CM-EFS.2S	1SVR730750R0400	0.157 (0.346)
			CM-EFS.2P	1SVR740750R0400	0.146 (0.322)

Current and voltage monitoring relays, single phase

Function diagrams

Function diagrams CM-SRS.1

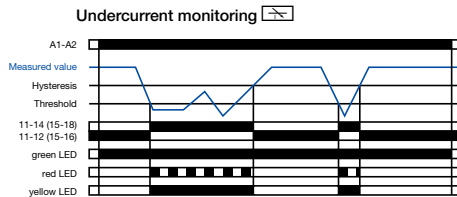
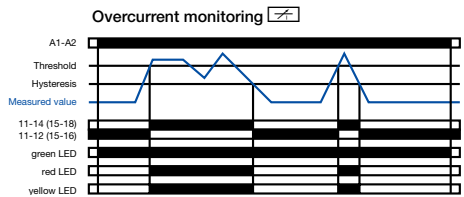

Function diagrams CM-SRS.2

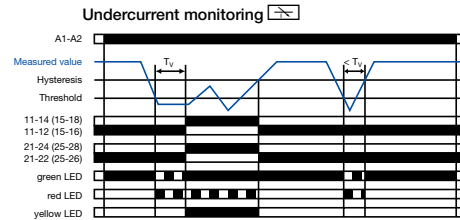
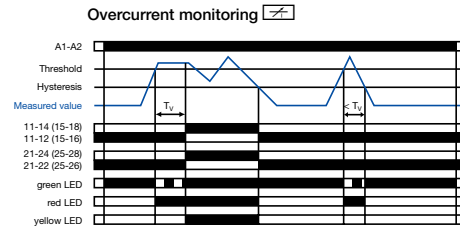

If the measured value exceeds resp. drops below the adjusted threshold value, the output relay(s) energize(s): on the CM-SRS.1 immediately, on the CM-SRS.2 after the set tripping delay T_v . If the measured value exceeds resp. drops below the threshold value plus resp. minus the adjusted hysteresis, the output relay(s) de-energize(s). The hysteresis is adjustable within a range of 3-30 % of the threshold value.

Function diagrams CM-SRS.M

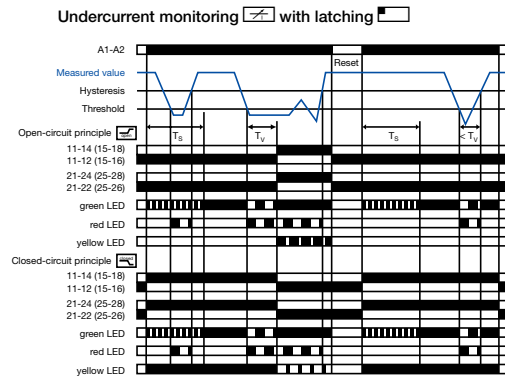
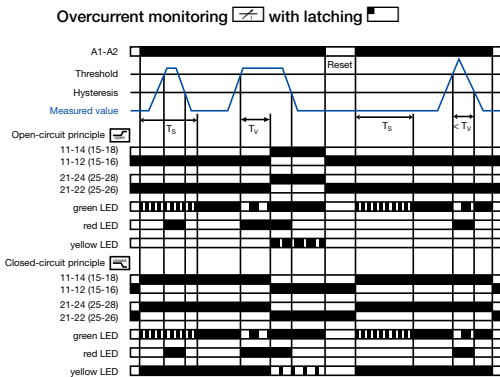
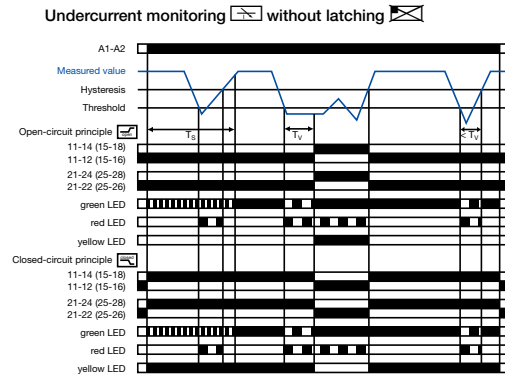
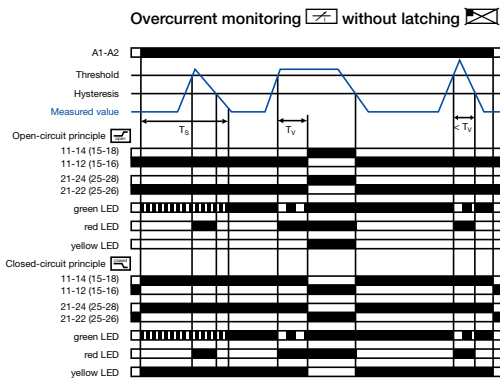

If the measured value exceeds resp. drops below the adjusted threshold value before the set start-up delay T_s is complete, the output relays do not change their actual state. If the measured value exceeds resp. drops below the adjusted threshold value when T_s is complete, the tripping delay T_v starts. If T_v is complete and the measured value is still exceeding resp. below the threshold value plus resp. minus the set hysteresis, the output relays energize / de-energize.

If the measured value exceeds resp. drops below the threshold value minus resp. plus the set hysteresis and the latching function is not activated, the output relays de-energize / energize. With activated latching function the output relays remain energized and de-energize only, when the supply voltage is interrupted / the output relays remain de-energized and energize only, when the supply voltage is switched off and then again switched on = Reset. The hysteresis is adjustable within a range of 3-30 % of the threshold value.

Current and voltage monitoring relays, single phase

Function diagrams

Function diagrams CM-SFS.2

Current window monitoring 1x2 c/o contact
ON-delayed without latching

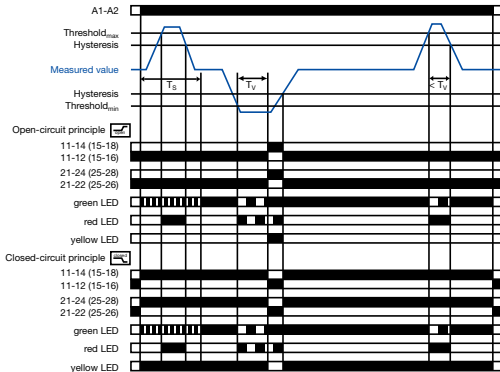

ON-delayed current window monitoring with parallel switching c/o contacts
If the measured value exceeds resp. drops below the adjusted threshold value before the set start-up delay T_s is complete, the output relays do not change their actual state.

If the measured value exceeds resp. drops below the adjusted threshold value when T_s is complete, the tripping delay T_v starts, when is configured. If T_v is complete and the measured value is still exceeding resp. below the threshold value minus resp. plus the fixed hysteresis (5%), the output relays energize / de-energize . If the measured value exceeds resp. drops below the threshold value plus resp. minus the hysteresis and the latching function is not activated , the output relays de-energize / energize . With activated latching function the output relays remain energized and de-energize only, when the supply voltage is interrupted / the output relays remain de-energized and energize only, when the supply voltage is switched off and then again switched on = Reset.

Further function diagrams see data sheet.

Current window monitoring 1x2 c/o contact
OFF-delayed without latching

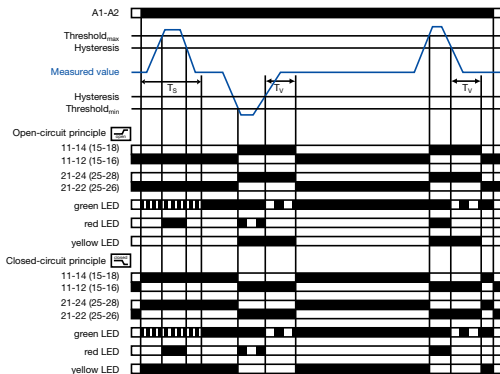

OFF-delayed current window monitoring with parallel switching c/o contacts
If the measured value exceeds resp. drops below the adjusted threshold value when the set start-up delay T_s is complete, the output relays energize / de-energize , when is configured, and remain in this position during the set tripping delay T_v .

If the measured value exceeds resp. drops below the threshold value plus resp. minus the fixed hysteresis (5%) and the latching function is not activated , the tripping delay T_v starts. After completion of T_v the output relays de-energize / energize , provided that the latching function is not activated . With activated latching function the output relays remain energized and de-energize only, when the supply voltage is interrupted / the output relays remain de-energized and energize only, when the supply voltage is switched off and then again switched on = Reset.

When is adjusted on the device, the functionality is equivalent to the one described above. There is only to consider that in this case, instead of both output relays, only one output relay each will be switched.

">" = 11₁₅-12₁₆/14₁₈ ; "<" = 21₂₅-22₂₆/24₂₈

Function diagrams CM-ESS.1

Overvoltage monitoring

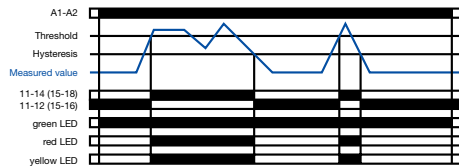

Undervoltage monitoring

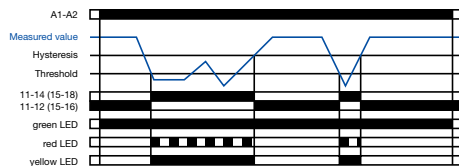

Function diagrams CM-ESS.2

Overvoltage monitoring

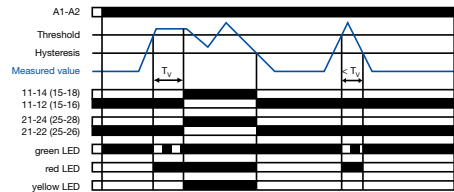

Undervoltage monitoring

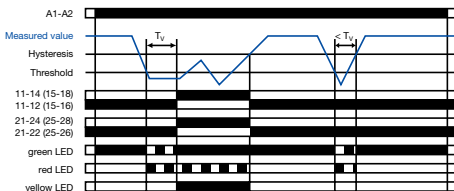

Depending on the configuration, the voltage monitoring relays **CM-ESS.1** and **CM-ESS.2** can be used for over- or undervoltage monitoring in single-phase AC and/or DC systems. The voltage to be monitored (measured value) is applied to terminals B-C. The devices work according to the open-circuit principle. If the measured value exceeds resp. drops below the adjusted threshold value, the output relay(s) energize(s): on the CM-ESS.1 immediately, on the CM-ESS.2 after the set tripping delay T_v . If the measured value exceeds resp. drops below the threshold value plus resp. minus the adjusted hysteresis, the output relay(s) de-energize(s). The hysteresis is adjustable within a range of 3-30 % of the threshold value.

Current and voltage monitoring relays, single phase

Function diagrams

Measuring & monitoring relays
CM Range

Function diagrams CM-ESS.M

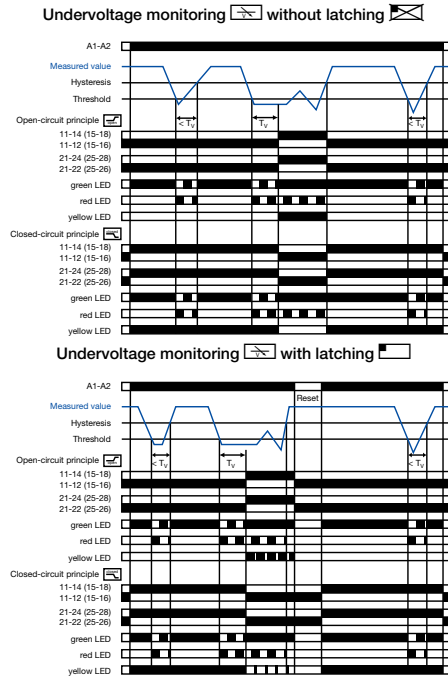
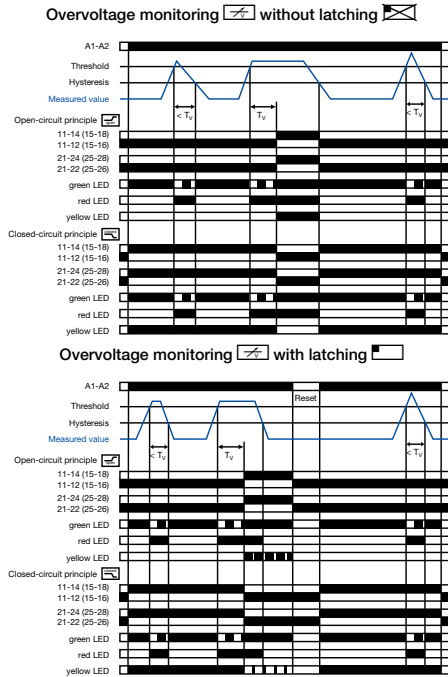

If the measured value exceeds resp. drops below the adjusted threshold value, the tripping delay T_v starts. If T_v is complete and the measured value is still exceeding resp. below the threshold value plus resp. minus the set hysteresis, the output relays energize / de-energize. If the measured value exceeds resp. drops below the threshold value plus resp. minus the set hysteresis and the latching function is not activated, the output relays de-energize / energize. With activated latching function the output relays remain energized and de-energize only, when the supply voltage is interrupted / the output relays remain de-energized and energize only, when the supply voltage is switched off and then again switched on = Reset. The hysteresis is adjustable within a range of 3-30 % of the threshold value. Further function diagrams see data sheet.

Voltage window monitoring 1x2 c/o contact

ON-delayed without latching

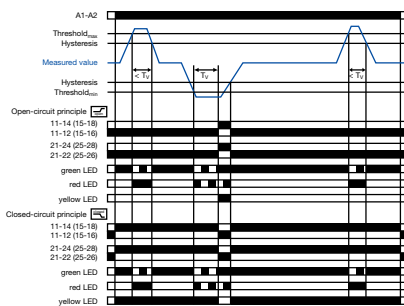

Voltage window monitoring 1x2 c/o contact

OFF-delayed without latching

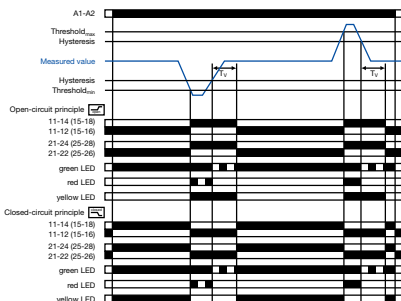

ON-delayed voltage window monitoring with parallel switching c/o contacts

If the measured value exceeds resp. drops below the adjusted threshold value, the tripping delay T_v starts, when is configured. If T_v is complete and the measured value is still exceeding resp. below the threshold value minus resp. plus the fixed hysteresis (5%), the output relays energize / de-energize.

If the measured value exceeds resp. drops below the threshold value plus resp. minus the hysteresis and the latching function is not activated, the output relays de-energize / energize. With activated latching function the output relays remain energized and de-energize only, when the supply voltage is interrupted / the output relays remain de-energized and energize only, when the supply voltage is switched off and then again switched on = Reset.

OFF-delayed voltage window monitoring with parallel switching c/o contacts

If the measured value exceeds resp. drops below the adjusted threshold value, the output relays energize / de-energize, when is configured, and remain in this position during the set tripping delay T_v .

If the measured value exceeds resp. drops below the threshold value plus resp. minus the fixed hysteresis (5%) and the latching function is not activated, the tripping delay T_v starts.

After completion of T_v , the output relays de-energize / energize, provided that the latching function is not activated. With activated latching function the output relays remain energized and de-energize only, when the supply voltage is interrupted / the output relays remain de-energized and energize only, when the supply voltage is switched off and then again switched on = Reset.

When is adjusted on the device, the functionality is equivalent to the one described above. There is only to consider that in this case, instead of both output relays, only one output relay each will be switched.

$$">U" = 11_{15-12_{16}}/14_{18}; "<U" = 21_{25-22_{26}}/24_{28}$$

Current and voltage monitoring relays, single phase

Connection diagrams

DIP switches

Connection diagram CM-SRS.1, CM-SRS.2

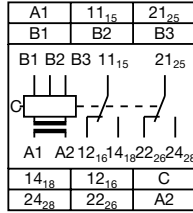
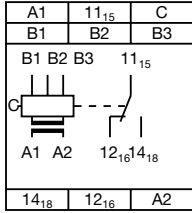

A1-A2 Control supply voltage
B1-C Measuring range 1:
3-30 mA or 0.3-1.5 A
B2-C Measuring range 2:
10-100 mA or 1-5 A
B3-C Measuring range 3:
0.1-1 A or 3-15 A
11₁₅-12₁₆/14₁₈ Output contacts -
open-circuit principle

A1-A2 Control supply voltage
B1-C Measuring range 1:
3-30 mA or 0.3-1.5 A
B2-C Measuring range 2:
10-100 mA or 1-5 A
B3-C Measuring range 3:
0.1-1 A or 3-15 A
11₁₅-12₁₆/14₁₈ Output contacts -
21₂₅-22₂₆/24₂₈ open-circuit principle

DIP switch functions CM-SRS.1, CM-SRS.2

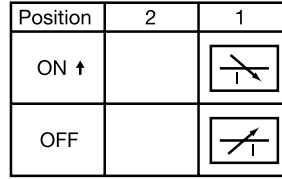

1 ON Undercurrent monitoring
OFF Overcurrent monitoring
OFF = Default

Connection diagram CM-SRS.M

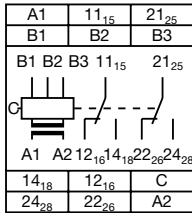

A1-A2 Control supply voltage
B1-C Measuring range 1:
3-30 mA bzw. 0.3-1.5 A
B2-C Measuring range 2:
10-100 mA bzw. 1-5 A
B3-C Measuring range 3:
0.1-1 A bzw. 3-15 A
11₁₅-12₁₆/14₁₈ Output contacts -
21₂₅-22₂₆/24₂₈ open-or
closed circuit principle

DIP switch functions CM-SRS.M

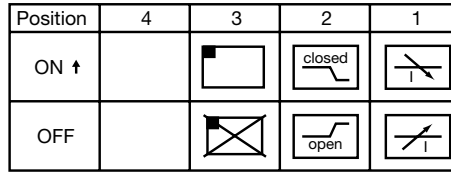

1 ON Undercurrent monitoring
OFF Overcurrent monitoring
3 ON Latching function activated
OFF Latching function not activated
2 ON Closed-circuit principle
OFF Open-circuit principle
OFF = Default

Connection diagram CM-SFS.2

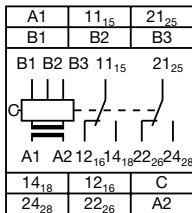

A1-A2 Control supply voltage
B1-C Measuring range 1:
3-30 mA or 0.3-1.5 A
B2-C Measuring range 2:
10-100 mA or 1-5 A
B3-C Measuring range 3:
0.1-1 A or 3-15 A
11₁₅-12₁₆/14₁₈ Output contacts -
21₂₅-22₂₆/24₂₈ open-or
closed circuit principle

DIP switch function CM-SFS.2

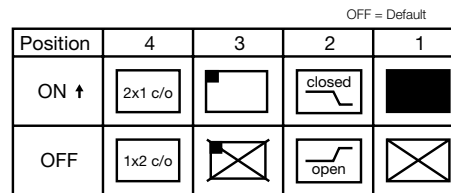

1 ON OFF-delay
OFF ON-delay
3 ON Latching function activated
OFF Latching function not activated
2 ON Closed-circuit principle
OFF Open-circuit principle
4 ON 2x1 c/o contact
OFF 1x2 c/o contacts

Connection diagram CM-ESS.M

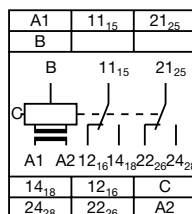

A1-A2 Control supply voltage
B-C Measuring ranges:
3-30 V; 6-60 V;
30-300 V; 60-600 V
11₁₅-12₁₆/14₁₈ Output contacts -
21₂₅-22₂₆/24₂₈ Open- or closed circuit
principle

DIP switch functions CM-ESS.M

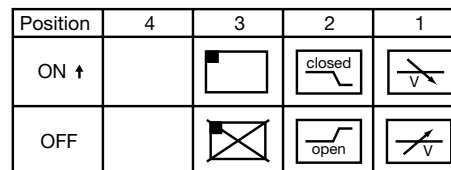

1 ON Undervoltage monitoring
OFF Overvoltage monitoring
3 ON Latching function activated
OFF Latching function not activated
2 ON Closed-circuit principle
OFF Open-circuit principle
OFF = Default

Current and voltage monitoring relays, single phase

Connection diagrams

DIP switches

Connection diagram CM-ESS.1, CM-ESS.2

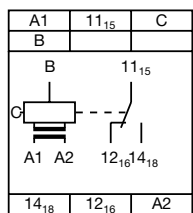

A1-A2 Control supply voltage
B-C Measuring ranges:
3-30 V; 6-60 V;
30-300 V; 60-600 V
11₁₅-12₁₆/14₁₈ Output contacts -
open-circuit principle

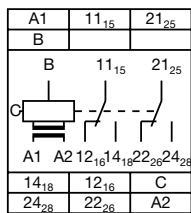

A1-A2 Control supply voltage
B-C Measuring ranges:
3-30 V; 6-60 V;
30-300 V; 60-600 V
11₁₅-12₁₆/14₁₈ Output contacts -
open-circuit principle
21₂₅-22₂₆/24₂₈

DIP switch functions CM-ESS.1, CM-ESS.2

Position	2	1
ON ↑		
OFF		

1 ON Undervoltage monitoring
OFF Overvoltage monitoring
OFF = Default

Connection diagram CM-EFS.2

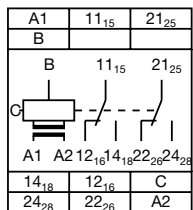

A1-A2 Control Supply voltage
B-C Measuring ranges:
3-30 V; 6-60 V;
30-300 V; 60-600 V
11₁₅-12₁₆/14₁₈ Output contacts -
open- or closed circuit
principle
21₂₅-22₂₆/24₂₈

DIP switch functions CM-EFS.2

Position	4	3	2	1
ON ↑				
OFF				

OFF = Default

1 ON ON-delay
OFF OFF-delay
2 ON Closed-circuit principle
OFF Open-circuit principle
3 ON Latching function activated
OFF Latching function not activated
4 2 x 1 c/o contact
1 x 2 c/o contacts

Current and voltage monitoring relays, single phase

Technical data

Type	CM-SRS.1	CM-SRS.2	CM-SRS.M	CM-SFS.2
Input circuit - Supply circuit				
Rated control supply voltage U_s	A1-A2	A1-A2		
	A1-A2	110-130 V AC		
	A1-A2	220-240 V AC		
Rated control supply voltage U_s tolerance		24-240 V AC/DC		
Rated frequency	AC versions	-15...+10 %		
	AC/DC versions	50/60 Hz		
Current / power consumption		50/60 Hz or DC		
Power failure buffering time		see data sheets		
Transient overvoltage protection		20 ms		
		Varistors		
Input circuit - Measuring circuit				
Monitoring function		B1/B2/B3-C		
		over- or undercurrent monitoring configurable		over- and under-current monitoring
Measuring method		True RMS measuring principle		
Measuring inputs		CM-SxS.x1		CM-SxS.x2
	Terminal connection	B1-C	B2-C	B3-C
	Measuring ranges AC/DC	3-30 mA	10-100 mA	0.1-1 A
	Input resistance	3.3 q	1 q	0.1 q
	Pulse overload capacity $t < 1$ s	500 mA	1 A	10 A
	Continuous capacity	50 mA	150 mA	1.5 A
Threshold value(s)		adjustable within the indicated measuring range		
Setting accuracy of threshold value		10 %		
Repeat accuracy (constant parameters)		0.07 % of full scale		
Hysteresis related to the threshold value		3-30 % adjustable		5 % fixed
Measuring signal frequency range		DC / 15 Hz - 2 kHz		
Rated measuring signal frequency range		DC / 50-60 Hz		
Maximum response time		AC: 80 ms / DC: 120 ms		
Accuracy within the control supply voltage tolerance		$\Delta U \leq 0.5 \%$		
Accuracy within the temperature range		$\Delta U \leq 0.06 \%$ / °C		
Timing circuit				
Start-up delay T_s		none	0 or 0.1-30 s adjustable	
Tripping delay T_V		none	0 or 0.1-30 s adjustable	
Repeat accuracy (constant parameters)		$\pm 0.07 \%$ of full scale		
Accuracy within the control supply voltage tolerance		-	$\Delta t \leq 0.5 \%$	
Accuracy within the temperature range		-	$\Delta t \leq 0.06 \%$ / °C	
Indication of operational states				
Control supply voltage	U/T: green LED			
Measured value	I: red LED			
Relay status	R: yellow LED			
Output circuits				
Kind of output		11(15)-12(16)/14(18), 21(25)-22(26)/24(28) - Relays		
		1 c/o contact	2 c/o contacts	1x2 c/o contacts or 2x1 c/o contact configurable
Operating principle ¹⁾		open-circuit principle		open- or closed-circuit principle configurable
Contact material		AgNi		
Rated operational voltage U_o	IEC/EN 60947-1	250 V		
Minimum switching voltage / minimum switching current		24 V / 10 mA		
Maximum switching voltage / maximum switching current		250 V AC / 4 A AC		
Rated operational current I_o (IEC/EN 60947-5-1)	AC12 (resistive) at 230 V	4 A		
	AC15 (inductive) at 230 V	3 A		
	DC12 (resistive) at 24 V	4 A		
	DC13 (inductive) at 24 V	2 A		
AC rating (UL 508)	Utilization category (Control Circuit Rating Code)	B 300		
	max. rated operational voltage	300 V AC		
	max. continuous thermal current at B 300	5 A		
	max. making/breaking apparent power (Make/Break) at B 300	3600/360 VA		
Mechanical lifetime		30x10 ⁶ switching cycles		
Electrical lifetime (AC12, 230 V, 4 A)		0.1x10 ⁶ switching cycles		
Max. fuse rating to achieve short-circuit protection	n/c contact	6 A fast-acting	10 A fast-acting	6 A fast-acting
	n/o contact	10 A fast-acting		

¹⁾ Open-circuit principle: output relay energizes if the measured value exceeds / falls below the adjusted threshold value
Closed-circuit principle: output relay de-energizes if measured value exceeds / falls below the adjusted threshold value

Current monitoring relays, single phase

Technical data







Measuring &
monitoring relays
CM Range





Type		CM-SRS.1	CM-SRS.2	CM-SRS.M	CM-SFS.2
General data					
MTBF				on request	
Duty time				100%	
Dimensions	product dimensions	22.5 x 85.6 x 103.7 mm (0.89 x 3.37 x 4.08 in)			
	packaging dimensions	97 x 109 x 30 mm (3.82 x 4.29 x 1.18 in)			
(W x H x D)					
Weight	net weight	depending on device, see ordering details			
	gross weight	depending on device, see ordering details			
Mounting		DIN rail (IEC/EN 60715), snap-on mounting without any tool			
Mounting position		any			
Minimum distance to other units		10mm (0.39in) at measured current > 10 A			
Material of housing		UL 94 V-0			
Degree of protection	housing / terminals	IP50 / IP20			
Electrical connection					
Wire size		Screw connection technology		Easy Connect Technology (Push-in)	
	fine-strand with(out) wire end ferrule	1 x 0.5-2.5 mm ² (1 x 20-14 AWG) 2 x 0.5-1.5 mm ² (2 x 20-16 AWG)		2 x 0.5-1.5 mm ² (2 x 20-16 AWG)	
	rigid	1 x 0.5-4 mm ² (1 x 20-12 AWG) 2 x 0.5-2.5 mm ² (2 x 20-14 AWG)		2 x 0.5-1.5 mm ² (2 x 20-16 AWG)	
Stripping length		8 mm (0.32 in)			
Tightening torque		0.6-0.8 Nm (5.31-7.08 lb.in)		-	
Environmental data					
Ambient temperature range	operation / storage	-20...+60 °C / -40...+85 °C			
Damp heat (IEC 60068-2-30)		55 °C, 6 cycles			
Vibration (sinusoidal) (IEC/EN 60255-21-1)		Class 2			
Shock (IEC/EN 60255-21-2)		Class 2			
Isolation data					
Rated insulation voltage (VDE 0110, IEC 60947-1, IEC/EN 60255-5)	supply / measuring circuit / output	600 V			
	supply / output 1/2	250 V			
Rated impulse withstand voltage U _{imp} (IEC/EN 60947-1, IEC/EN 60255-5) ²⁾	supply / measuring circuit / output	6 kV 1.2/50 µs			
	supply / output 1/2	4 kV 1.2/50 µs			
Pollution degree (VDE 0110, IEC 664, IEC/EN 60255-5)		3			
Overvoltage category (VDE 0110, IEC 664, IEC/EN 60255-5)		III			
Standards					
Product standard		IEC/EN 60255-6			
Low Voltage Directive		2006/95/EC			
EMC Directive		2004/108/EC			
Electromagnetic compatibility					
Interference immunity to		IEC/EN 61000-6-2			
electrostatic discharge	IEC/EN 61000-4-2	Level 3			
radiated, radio-frequency, electromagnetic field	IEC/EN 61000-4-3	Level 3			
electrical fast transient / burst	IEC/EN 61000-4-4	Level 3			
surge	IEC/EN 61000-4-5	Level 3			
conducted disturbances, induced by radio-frequency fields	IEC/EN 61000-4-6	Level 3			
Interference emission		IEC/EN 61000-6-3			
high-frequency radiated	IEC/CISPR 22; EN 55022	Class B			
high-frequency conducted	IEC/CISPR 22; EN 55022	Class B			

²⁾ In case of measured currents > 10 A, lateral spacing has to be min. 10 mm

Voltage monitoring relays, single phase

Technical data

Type	CM-ESS.1	CM-ESS.2	CM-ESS.M	CM-EFS.2
Input circuit - Supply circuit	A1-A2			
Rated control supply voltage U_s	A1-A2	110-130 V AC		220-240 V AC
	A1-A2	220-240 V AC		
	A1-A2	24-240 V AC/DC		
Rated control supply voltage U_s tolerance		-15...+10 %		
Rated frequency	AC versions	50/60 Hz		50/60 Hz or DC
	AC/DC versions	50/60 Hz or DC		
Current / power consumption		see data sheet		
Power failure buffering time		20 ms		
Transient overvoltage protection		Varistors		
6 Input circuit - Measuring circuit	B-C			
Monitoring function	Over or undervoltage monitoring configurable		Over and undervoltage monitoring configurable	
Measuring method	True RMS measuring principle			
Measuring inputs	CM-ExS			
	Terminal connection	B-C	B-C	B-C
	Measuring range AC/DC	3-30 V	6-60 V	30-300 V
	Input resistance	600 k Ω	600 k Ω	600 k Ω
	Pulse overload capacity $t < 1$ s	800 V	800 V	800 V
	Continuous capacity	660 V	660 V	660 V
Threshold value(s)	adjustable within the indicated measuring range			
Setting accuracy of threshold value	10 %			
Repeat accuracy (constant parameters)	± 0.07 % of full scale			
Hysteresis related to the threshold value	3-30 % adjustable		5 % fixed	
Measuring signal frequency range	DC / 15 Hz - 2 kHz			
Rated measuring signal frequency range	DC / 50-60 Hz			
Maximum response time	AC: 80 ms / DC: 120 ms			
Accuracy within the control supply voltage tolerance	$\Delta U \leq 0.5$ %			
Accuracy within the temperature range	$\Delta U \leq 0.06$ % / $^{\circ}\text{C}$			
Transient overvoltage protection	Varistors			
Timing circuit				
Delay time T_v	none	0 or 0.1-30 s adjustable		
Repeat accuracy (constant parameters)	± 0.07 % of full scale			
Accuracy within the control supply voltage tolerance	-	$\Delta t \leq 0.5$ %		
Accuracy within the temperature range	-	$\Delta t \leq 0.06$ % / $^{\circ}\text{C}$		
Indication of operational states				
Control supply voltage	U/T: green LED	 : control supply voltage applied  : tripping delay T_v active		
Measured value	U: red LED	 : overvoltage,  : undervoltage		
Relay status	R: yellow LED	 : relay energized, no latching function  : relay energized, active latching function  : relay de-energized, active latching function		
Output circuits				
Kind of output	1 c/o contact	2 c/o contacts	1x2 c/o contacts or 2x1 c/o contact configurable	
Operating principle ¹⁾	open-circuit principle		open- or closed-circuit principle configurable	
Contact material	AgNi			
Rated operational voltage U_s	IEC/EN 60947-1 250 V			
Minimum switching voltage / minimum switching current	24 V / 10 mA			
Maximum switching voltage / maximum switching current	250 V AC / 4 A AC			
Rated operational current I	AC12 (resistive) at 230 V	4 A		
	AC15 (inductive) at 230 V	3 A		
(IEC/EN 60947-5-1)	DC12 (resistive) at 24 V	4 A		
	DC13 (inductive) at 24 V	2 A		

¹⁾ Open-circuit principle: output relay energizes if the measured value exceeds  / falls below  the adjusted threshold value
 Closed-circuit principle: output relay de-energizes if measured value exceeds  / falls below  the adjusted threshold value²⁾

Voltage monitoring relays, single phase

Technical data

Measuring &
monitoring relays
CM Range

Type		CM-ESS.1	CM-ESS.2	CM-ESS.M	CM-EFS.2
AC rating (UL 508)	Utilization category (Control Circuit Rating Code)			B 300	
	max. rated operational voltage			300 V AC	
	max. continuous thermal current at B 300			5 A	
	max. making/breaking apparent power (Make/Break) at B 300			3600/360 VA	
	Mechanical lifetime			30x10 ⁶ switching cycles	
Electrical lifetime (AC12, 230 V, 4 A)			0.1x10 ⁶ switching cycles		
Max. fuse rating to achieve short-circuit protection	n/c contact	6 A fast-acting		10 A fast-acting	6 A fast-acting
	n/o contact			10 A fast-acting	
General data					
MTBF				on request	
Duty time				100%	
Dimensions (W x H x D)	product dimensions			22.5 x 85.6 x 103.7 mm (0.89 x 3.37 x 4.08 in)	
	packaging dimensions			97 x 109 x 30 mm (3.82 x 4.29 x 1.18 in)	
Weight	net weight			depending on device, see ordering details	
	gross weight			depending on device, see ordering details	
Mounting				DIN rail (IEC/EN 60715), snap-on mounting without any tool	
Mounting position				any	
Minimum distance to other units	vertical / horizontal			not necessary / not necessary	
Material of housing				UL 94 V-0	
Degree of protection	housing / terminals			IP50 / IP20	
Electrical connection					
Wire size		Screw connection technology		Easy Connect Technology (Push-in)	
	fine-strand with(out) wire end ferrule	1 x 0.5-2.5 mm ² (1 x 20-14 AWG)		2 x 0.5-1.5 mm ² (2 x 20-16 AWG)	
		2 x 0.5-1.5 mm ² (2 x 20-16 AWG)			
	rigid	1 x 0.5-4 mm ² (1 x 20-12 AWG)		2 x 0.5-1.5 mm ² (2 x 20-16 AWG)	
2 x 0.5-2.5 mm ² (2 x 20-14 AWG)					
Stripping length			8 mm (0.32 in)		
Tightening torque		0.6-0.8 Nm (5.31-7.08 lb.in)			-
Isolation data					
Rated insulation voltage (VDE 0110, IEC 60947-1, IEC/EN 60255-5)	supply / measuring circuit / output			600 V	
	supply / output 1/2			250 V	
	supply / output 1/2				
Rated impulse withstand voltage U _i (IEC/EN 60947-1, IEC/EN 60255-5) ^{imp}	supply / measuring circuit / output			6 kV 1.2/50 μs	
	supply / output 1/2			4 kV 1.2/50 μs	
	supply / output 1/2				
Pollution degree (VDE 0110, IEC 664, IEC/EN 60255-5)				3	
Overvoltage category (VDE 0110, IEC 664, IEC/EN 60255-5)				III	
Standards					
Product standard				IEC/EN 60255-6	
Low Voltage Directive				2006/95/EC	
EMC Directive				2004/108/EC	
Electromagnetic compatibility					
Interference immunity to				IEC/EN 61000-6-2	
electrostatic discharge	IEC/EN 61000-4-2			Level 3	
	radiated, radio-frequency, electromagnetic field	IEC/EN 61000-4-3		Level 3	
electrical fast transient / burst surge	IEC/EN 61000-4-4			Level 3	
	IEC/EN 61000-4-5			Level 3	
conducted disturbances, induced by radio-frequency fields	IEC/EN 61000-4-6			Level 3	
	Interference emission			IEC/EN 61000-6-3	
high-frequency radiated high-frequency conducted	IEC/CISPR 22; EN 55022			Class B	
	IEC/CISPR 22; EN 55022			Class B	

6

CM-E Range

Three-phase monitoring relays











Three-phase monitoring relays
Benefits, advantages, & applications



Three-phase monitoring relays

Benefits, advantages, & applications

Characteristics of the CM range three-phase monitors

- Adjustable phase unbalance threshold value ¹⁾
- Adjustable ON-delay/OFF-delay time ¹⁾
- Dual frequency measuring 50/60 Hz
- Powered by the measuring circuit
- 1 n/o contact, 1 or 2 contacts
- LED status indication
- Approvals:      
- Marks:  
- Multifunctional and single-functional devices
- Phase loss monitoring
- Phase sequence monitoring ¹⁾
- Over- and undervoltage monitoring (fixed or adjustable)¹⁾
- Wide-range operating voltage guarantees world-wide operation

¹⁾ depending on device type

Phase unbalance monitoring

If the supply by the three-phase system is unbalanced due to uneven distribution of the load, the motor will convert a part of the energy into reactive power. This energy gets lost unexploited; also the motor is exposed to higher thermal strain. Other thermal protection devices fail to detect continuing unbalances which can lead to damage or destruction of the motor. The CM range three-phase monitors with phase unbalance monitoring can reliably detect this critical situation.

Phase sequence

Changing the phase sequence during operation or a wrong phase sequence prior to startup causes a change of the rotational direction of the connected device. Generators, pumps or fans rotate in the wrong direction and the installation is no longer working properly. Especially for moveable equipment, such as construction machinery, phase sequence detection prior to the startup process is highly reasonable.

Phase loss

In case of phase loss, undefined stats of the installation are likely to occur. E.g. the startup process of motors is disturbed. All three-phase monitors of the ABB CM range detect a phase loss as soon as the voltage of one phase drops below 60% of its nominal value.

Voltage monitoring

All electric devices can be damaged when operated continuously in a network with out-of-range voltages. For example, safe starting is not ensured in case of undervoltage. Also, the switching state of a contactor is not clearly defined when operated in a „forbidden“ voltage range. This can lead to undefined stats of the installation and cause damage or destruction of valuable parts.

Expanded functionality

ABB's new generation of three-phase monitoring relays feature additional functions making the application field for the devices considerably larger.

Selectable phase sequence monitoring

The phase sequence monitoring can be switched off by means of a rotary switch or a DIP switch. This enables monitoring of three-phase mains where phase sequence is not relevant for the application, for example in case of motors with forward and reverse rotation, heating applications, etc.

Automatic phase sequence correction

The automatic phase sequence correction is activated by means of a DIP switch. With activated phase sequence correction, it is ensured that for any non-fixed or portable equipment, e.g. construction machinery, the correct phase sequence is always applied to the input terminals of the load. For details regarding the wiring, please see function description / diagrams.

Structure of the type designation

CM-__ x.yz

x: width of enclosure

y: Control supply voltage / measuring range

1	110, 115, 120, 127 V supply systems (phase-neutral)
2	220, 230, 240 V supply systems (phase-neutral)
3	200, 208, 220, 230, 240, 257, 260 V supply systems (phase-phase)
4	440, 460 V supply systems (phase-phase)
5	480, 500 V supply systems (phase-phase)
6	575, 600 V supply systems (phase-phase)
7	660, 690 V supply systems (phase-phase)
8	200, 400 V supply systems (phase-phase)

z: Rated frequency / output circuit

1	50/60 Hz – 1x2 c/o
2	50/60 Hz – 1x2 or 2x1 c/o
3	50/60/400 Hz – 1x2 oder 2x1 c/o



1 Threshold value V_{min}/V_{max}

2 R/T: yellow LED
Relay status, timing

F1: red LED
fault message

F2: red LED failure:
- overvoltage: F1
- undervoltage: F2

- phase unbalance:
F1 and F2 constant
- phase loss: F1 on F2
flashing

- phase sequence:
F1 and F2 alternately flashing

3 Adjustment of the tripping delay

4 Time setting 0.1-10 s
Phase sequence and phase loss
are indicated without any time delay

Three-phase monitoring relays

Selection and conversion

Measuring & monitoring relays
CM Range

Rated control supply voltage U_s	Reference code	Catalog number	Predecessor
	CM-PBE	1SVR550881R9400	
	CM-PBE	1SVR550882R9500	
	CM-PVE	1SVR550870R9400	no predecessor
	CM-PVE	1SVR550871R9500	
	CM-PFE	1SVR550824R9100	
	CM-PFS.S ¹⁾	1SVR730824R9300	1SVR630824R9300
	CM-PFS.P ¹⁾	1SVR740824R9300	
	CM-PSS.31S	1SVR730784R2300	1SVR630784R2300
	CM-PSS.31P	1SVR740784R2300	
	CM-PSS.41S	1SVR730784R3300	1SVR630784R3300
	CM-PSS.41P	1SVR740784R3300	
	CM-PVS.31S	1SVR730794R1300	1SVR63079 R1300
	CM-PVS.31P	1SVR740794R1300	
	CM-PVS.41S	1SVR730794R3300	1SVR630794R3300
	CM-PVS.41P	1SVR740794R3300	
	CM-PVS.81S	1SVR730794R2300	1SVR630794R2300
	CM-PVS.81P	1SVR740794R2300	
	CM-PAS.31S	1SVR730774R1300	1SVR630774R1300
	CM-PAS.31P	1SVR740774R1300	
	CM-PAS.41S	1SVR730774R3300	1SVR630774R3300
	CM-PAS.41P	1SVR740774R3300	
	CM-MPS.11S	1SVR730885R1300	1SVR630885R1300
	CM-MPS.11P	1SVR740885R1300	
	CM-MPS.21S	1SVR730885R3300	1SVR630885R3300
	CM-MPS.21P	1SVR740885R3300	
	CM-MPS.31S	1SVR730884R1300	1SVR630884R1300
	CM-MPS.31P	1SVR740884R1300	
Phase to Phase			
160-300 V AC			
200-400 V AC			
200-500 V AC			
208-440 V AC			
300-500 V AC			
320-460 V AC			
350-580 V AC			
380 V AC			
380-440 V AC	■	■	
400 V AC			
450-720 V AC			
530-820 V AC			
Phase to Neutral			
90-170 V AC			
180-280 V AC			
185-265 V AC			
220-240 V AC	■		
230 V AC			
Rated frequency			
50/60 Hz	■	■	■
50/60/400 Hz			
Suitable for monitoring			
Single-phase mains	■	■	
Three-phase mains	■	■	■
Monitoring function			
Phase failure	■	■	■
Phase sequence			
Automatic phase sequence correction			
Overvoltage		■	■
Undervoltage		■	■
Unbalance			
Neutral	■	■	
Overfrequency			
Underfrequency			
Thresholds			
fix	fix	fix	fix
Timing functions for tripping delay			
ON delay			
On and OFF delay	fix	fix	fix
Connection type			
Easy Connect Technology			
Double-chamber cage connection terminals			

Three-phase monitoring relays

Selection and conversion

6

Rated control supply voltage U_s

Reference code	Catalog number	Predecessor
CM-MPS.41S	1SVR730884R3300	1SVR630884R4300
CM-MPS.41P	1SVR740884R3300	
CM-MPS.23S	1SVR730885R4300	1SVR630885R4300
CM-MPS.23P	1SVR740885R4300	
CM-MPS.43S	1SVR730884R4300	1SVR630884R4300
CM-MPS.43P	1SVR740884R4300	
CM-MPN.52S ⁽¹⁾	1SVR750487R8300	1SVR650487R8300
CM-MPN.52P ⁽¹⁾	1SVR760487R8300	
CM-MPN.62S ⁽¹⁾	1SVR750488R8300	1SVR650488R8300
CM-MPN.62P ⁽¹⁾	1SVR760488R8300	
CM-MPN.72S ⁽¹⁾	1SVR750489R8300	1SVR650489R8300
CM-MPN.72P ⁽¹⁾	1SVR760489R8300	

	1	2	3	4	5	6	7	8	9	10	11	12
Phase to Phase												
160-300 V AC												
200-400 V AC												
200-500 V AC												
208-440 V AC												
300-500 V AC	■	■										
320-460 V AC												
350-580 V AC												
380 V AC												
380-440 V AC												
400 V AC												
450-720 V AC												
530-820 V AC												
Phase to Neutral												
90-170 V AC												
180-280 V AC												
185-265 V AC												
220-240 V AC												
230 V AC												
Rated frequency												
50/60 Hz	■	■										
50/60/400 Hz												
Suitable for monitoring												
Single-phase mains												
Three-phase mains	■	■	■	■	■	■	■	■	■	■	■	■
Monitoring function												
Phase failure	■	■	■	■	■	■	■	■	■	■	■	■
Phase sequence	sel	sel	adj	adj	adj	adj	adj	adj	adj	adj	adj	adj
Automatic phase sequence correction			adj	adj	adj	adj	adj	adj	adj	adj	adj	adj
Overvoltage	■	■	■	■	■	■	■	■	■	■	■	■
Undervoltage	■	■	■	■	■	■	■	■	■	■	■	■
Unbalance	■	■	■	■	■	■	■	■	■	■	■	■
Neutral			■	■								
Overfrequency												
Underfrequency												
Thresholds	adj	adj	adj	adj	adj	adj	adj	adj	adj	adj	adj	adj
Timing functions for tripping delay												
ON delay												
On and OFF delay	adj	adj	adj	adj	adj	adj	adj	adj	adj	adj	adj	adj
Connection type												
Easy Connect Technology		■		■		■		■		■		■
Double-chamber cage connection terminals	■		■		■		■		■		■	

Three-phase monitoring relays

Ordering details

Description

Only reliable and continuous monitoring of a three-phase network guarantees the trouble-free and economic operation of machines and installations.



CM-PBE



CM-PSS.41P



CM-PAS.31P

Ordering details

Rated control supply voltage = measuring voltage	Monitoring function	Neutral monitoring	Reference code	Catalog number	Weight (1 pce) kg (lb)
3x380-440 V AC, 220-240 V AC	Phase failure detection (Single- and three-phase)	■	CM-PBE ¹⁾	1SVR550881R9400	0.08 (0.17)
3x380-440 V AC			CM-PBE	1SVR550882R9500	0.08 (0.17)
3x320-460 V AC, 185-265 V AC	Over- / under-voltage and phase failure detection (Single- and three-phase)	■	CM-PVE ¹⁾	1SVR550870R9400	0.08 (0.17)
3x320-460 V AC			CM-PVE	1SVR550871R9500	0.08 (0.17)
3x208-440 V AC	Phase sequence monitoring and phase failure detection (Three-phase)		CM-PFE ²⁾	1SVR550824R9100	0.08 (0.17)
3x200-500 V AC			CM-PFS ²⁾	1SVR430824R9300	0.15 (0.33)
3x380 V AC	Over- / undervoltage with fixed threshold values $\pm 10\%$		CM-PSS.31S	1SVR730784R2300	0.132 (0.291)
			CM-PSS.31P	1SVR740784R2300	0.123 (0.271)
3x400 V AC			CM-PSS.41S	1SVR740784R3300	0.132 (0.291)
			CM-PSS.41P	1SVR730784R3300	0.123 (0.271)
3x160-300 V AC	Over- and under-voltage with adjustable threshold values (Three-phase)		CM-PVS.31S	1SVR730794R1300	0.141 (0.311)
			CM-PVS.31P	1SVR740794R1300	0.132 (0.291)
3x300-500 V AC			CM-PVS.41S	1SVR730794R3300	0.139 (0.306)
			CM-PVS.41P	1SVR740794R3300	0.131 (0.289)
3x200-400 V AC			CM-PVS.81S	1SVR730794R2300	0.136 (0.300)
			CM-PVS.81P	1SVR740794R2300	0.128 (0.282)
3x160-300 V AC	Phase unbalance (Three-phase)		CM-PAS.31S	1SVR730774R1300	0.133 (0.293)
			CM-PAS.31P	1SVR740774R1300	0.124 (0.273)
3x300-500 V AC			CM-PAS.41S	1SVR730774R3300	0.132 (0.291)
			CM-PAS.41P	1SVR740774R3300	0.123 (0.271)

¹⁾ The version with neutral monitoring is also suitable for monitoring single-phase mains. For this, all three external conductors (L1,L2,L3) have to be jumpered and connected as one single conductor.

²⁾ For applications where a reverse fed voltage >60% is expected, we recommend to use our three-phase monitoring relays for unbalance CM-PAS.xx

Three-phase monitoring relays

Ordering details

Ordering details

Rated control supply voltage = measuring voltage	Monitoring function	Neutral monitoring	Reference code	Catalog number	Weight (1 pce) kg (lb)		
90-170 V AC	Multifunctional (Three-phase phase failure detection, Phase sequence monitoring, overvoltage, undervoltage, Phase unbalance)	■	CM-MPS.11S	1SVR730885R1300	0.148 (0.326)		
			CM-MPS.11P	1SVR740885R1300	0.137 (0.302)		
CM-MPS.21S			1SVR730885R3300	0.146 (0.322)			
CM-MPS.21P			1SVR740885R3300	0.135 (0.298)			
3x300-500 V AC			CM-MPS.31S	1SVR730884R1300	0.142 (0.313)		
			CM-MPS.31P	1SVR740884R1300	0.133 (0.293)		
			CM-MPS.41S	1SVR730884R3300	0.140 (0.309)		
180-280 V AC			Multifunctional (Three-phase phase failure detection, Phase sequence monitoring, overvoltage, undervoltage, Phase unbalance)	■	CM-MPS.41P	1SVR740884R3300	0.132 (0.291)
					CM-MPS.23S	1SVR730885R4300	0.149 (0.328)
	CM-MPS.23P	1SVR740885R4300			0.138 (0.304)		
3x300-500 V AC	CM-MPS.43S	1SVR730884R4300			0.148 (0.327)		
	CM-MPS.43P	1SVR740884R4300			0.137 (0.302)		
3x350-580 V AC	CM-MPN.52S	1SVR750487R8300			0.230 (0.507)		
	CM-MPN.52P	1SVR760487R8300			0.226 (0.498)		
3x450-720 V AC	CM-MPN.62S	1SVR750488R8300			0.229 (0.505)		
	CM-MPN.62P	1SVR760488R8300			0.225 (0.496)		
3x530-820 V AC	CM-MPN.72S	1SVR750489R8300	0.224 (0.494)				
	CM-MPN.72P	1SVR760489R8300	0.220 (0.485)				
3 x 400 V AC (L-L) / 230 V AC (L-N)	see Three-Phase overview page	■	CM-UFS.2	1SVR630736R1300	0.140 (0.309)		
24-240 V AC/DC	Grid feeding monitoring (overvoltage, undervoltage, change in grid frequency)		CM-UFD.M21	1SVR510730R0300	0.225 (0.496)		
24 V AC/DC or 230 V AC			CM-UFD.M32	1SVR510730R4400	0.395 (0.871)		



CM-MPS.23P



CM-MPN.52P

Three-phase monitoring relays

Function diagrams

Function diagrams - Three-phase monitoring CM-PBE

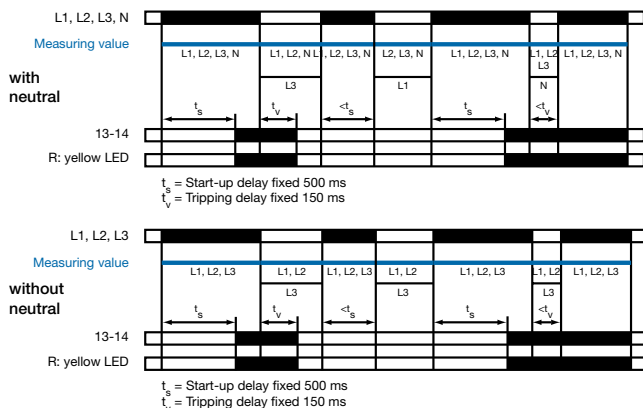

If all phases (and the neutral) are present, the output relay energizes after the start-up delay t_s is complete. If a phase failure occurs, the tripping delay t_v starts. When timing is complete, the output relay de-energizes. As soon as the voltage returns to the tolerance range, timing of t_s starts. When timing is complete, the output relay re-energizes automatically. The yellow LED glows when the output relay is energized.

Function diagrams - Three-phase monitoring CM-PVE

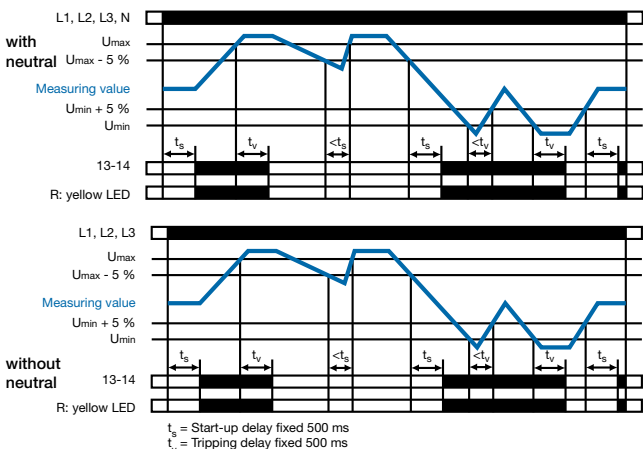

If all phases (and the neutral) are present with correct voltage, the output relay energizes after the start-up delay t_s is complete. If the voltage exceeds or falls below the fixed threshold value or if a phase failure occurs, the tripping delay t_v starts. When timing is complete, the output relay de-energizes. As soon as the voltage returns to the tolerance range, timing of t_s starts. When timing is complete, the output relay re-energizes automatically. The yellow LED glows when the output relay is energized.

Function diagram - CM-PFE

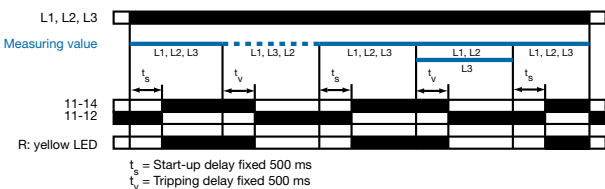

If all phases are present with the correct phase sequence, the output relay energizes after the start-up delay t_s is complete. If a phase failure or a phase sequence error occurs, the tripping delay t_v starts. When timing is complete, the output relay de-energizes. The yellow LED glows when the output relay is energized.

In case of motors which continue running with only two phases, the CM-PFE detects phase failure if the reverse fed voltage is less than 60 % of the originally applied voltage.

Function diagram - CM-PFS

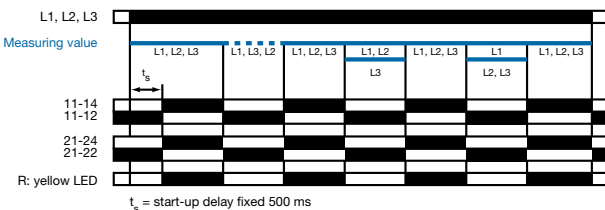

If all phases are present with the correct phase sequence, the output relay energizes after the start-up delay t_s is complete. If a phase failure or a phase sequence error occurs, the output relay de-energizes instantaneously. The yellow LED glows when the output relay is energized.

In case of motors which continue running with only two phases, the CM-PFS detects phase failure if the reverse fed voltage is less than 60 % of the originally applied voltage.

ATTENTION

If several CM-PFS units are placed side by side and the control supply voltage is higher than 415 V, spacing of at least 10 mm has to be kept between the individual units.

Three-phase monitoring relays

Function diagrams

Phase sequence and phase failure monitoring CM-PSS.xx, CM-PVS.xx, CM.PAS.xx, CM-MPS.xx, CM-MPN.xx

Applying control supply voltage begins the fixed start-up delay t_s . When t_s is complete and all phases are present with correct voltage, the output relays energize and the yellow LED R/T glows.

Phase sequence monitoring

If phase sequence monitoring is activated, the output relays de-energize as soon as a phase sequence error occurs. The fault is displayed by alternated flashing of the LEDs F1 and F2. The output relays re-energize automatically as soon as the phase sequence is correct again.

Phase failure monitoring

The output relays de-energize instantaneous if a phase failure occurs. The fault is indicated by lightning of LED F1 and flashing of LED F2. The output relays re-energize automatically as soon as the voltage returns to the tolerance range.

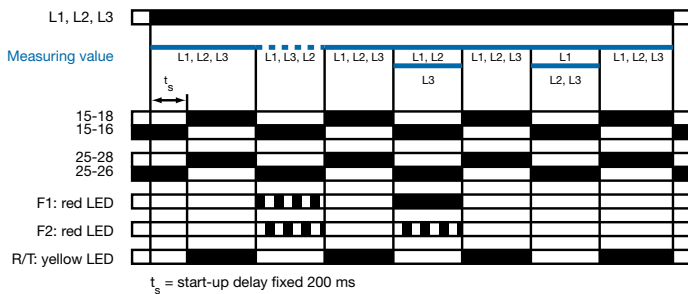

Interrupted neutral monitoring CM-MPS.11, CM-MPS.21, CM-MPS.23

The interruption of the neutral in the main to be monitored is detected by means of phase unbalance evaluation.

Determined by the system, in case of unloaded neutral, i.e. symmetrical load between all three phases, it may happen that an interruption of the neutral will not be detected.

If the star point is displaced by asymmetrical load in the three-phase main, an interrupted neutral will be detected.

Displacement of the star point

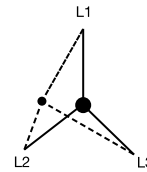

Automatic phase sequence correction CM-MPS.x3, CM-MPN.x2

This function can be selected only if phase sequence monitoring is activated and operating mode 2x1 c/o (SPDT) contact is selected.

Applying control supply voltage begins the fixed start-up delay t_{s1} . When t_{s1} is complete and all phases are present with correct voltage, output relay R1 energizes. Output relay R2 energizes when the fixed start-up delay t_{s2} is complete and all phases are present with correct phase sequence. Output relay R2 remains de-energized if the phase sequence is incorrect.

If the voltage to be monitored exceeds or falls below the set threshold values for phase unbalance, over- or undervoltage or if a phase failure occurs, output relay R1 de-energizes and the LEDs F1 and F2 indicate the fault.

Output relay R2 is responsive only to a false phase sequence. In conjunction with a reversing contactor combination, this enables an automatic correction of the rotation direction. See circuit diagrams on the right.

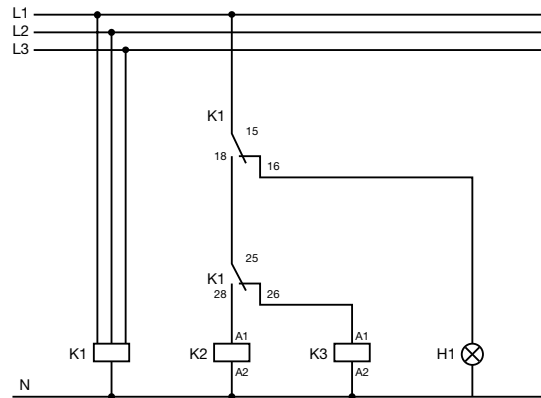
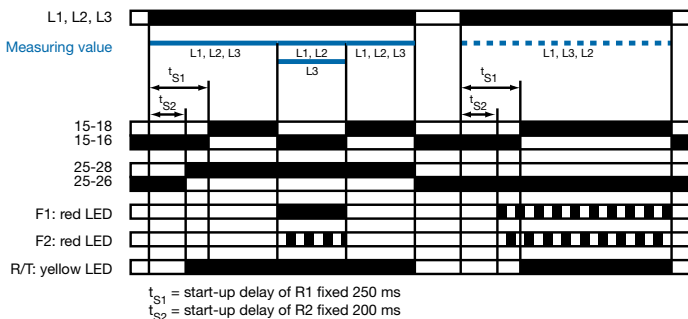

Control circuit diagram (K1 = CM-MPS.xx or CM-MPN.xx)

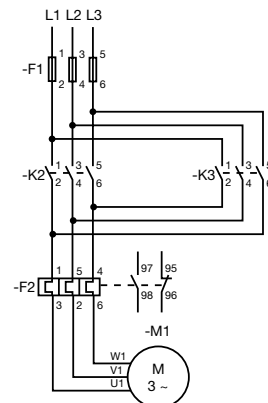

Power circuit diagram

Three-phase monitoring relays

Function diagrams

Over- and undervoltage monitoring 1x2 c/o

CM-PSS.xx¹, CM-PVS.xx², CM-MPS.xx², CM-MPN.xx²

Applying control supply voltage begins the fixed start-up delay t_s . When t_s is complete and all phases are present with correct voltage and with correct phase sequence, the output relays energize and the yellow LED R/T glows.

Type of tripping delay = ON-delay

If the voltage to be monitored exceeds or falls below the fixed¹⁾ or set²⁾ threshold value, the output relays de-energize after the set tripping delay t_v is complete. The LED R/T flashes during timing and turns off as soon as the output relays de-energize.

The output relays re-energize automatically as soon as the voltage returns to the tolerance range, taking into account a fixed hysteresis of 5 % and the LED R/T glows.

Type of tripping delay = OFF-delay

If the voltage to be monitored exceeds or falls below the fixed¹⁾ or set²⁾ threshold value, the output relays de-energize instantaneously and the LED R/T turns off.

As soon as the voltage returns to the tolerance range, taking into account a fixed hysteresis of 5 %, the output relays re-energize automatically after the set tripping delay t_v is complete. The LED R/T flashes during timing and turns steady when timing is complete.

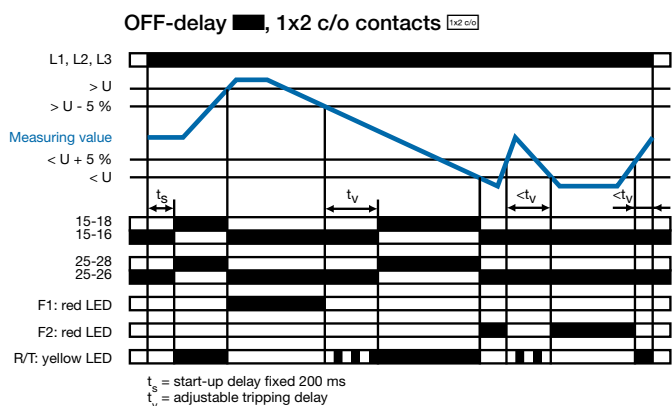
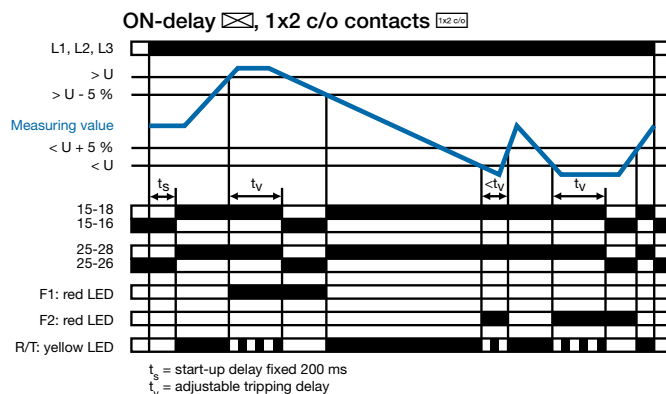

Over- and undervoltage monitoring 2x1 c/o

CM-MPS.x3, CM-MPN.x2

Applying control supply voltage begins the fixed start-up delay t_s . When t_s is complete and all phases are present with correct voltage and with correct phase sequence, the output relays energize. The yellow LED R/T glows as long as at least one output relay is energized.

Type of tripping delay = ON-delay

If the voltage to be monitored exceeds or falls below the set threshold value, output relay R1 (overvoltage) or output relay R2 (undervoltage) de-energizes after the set tripping delay t_v is complete. The LED R/T flashes during timing.

The corresponding output relay re-energizes automatically as soon as the voltage returns to the tolerance range, taking into account a fixed hysteresis of 5 %.

Type of tripping delay = OFF-delay

If the voltage to be monitored exceeds or falls below the set threshold value, output relay R1 (overvoltage) or output relay R2 (undervoltage) de-energizes instantaneously.

As soon as the voltage returns to the tolerance range, taking into account a fixed hysteresis of 5 %, the corresponding output relay re-energizes automatically after the set tripping delay t_v is complete. The LED R/T flashes during timing.

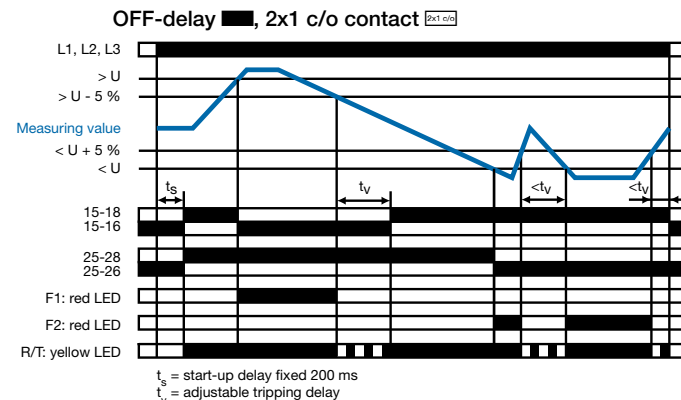
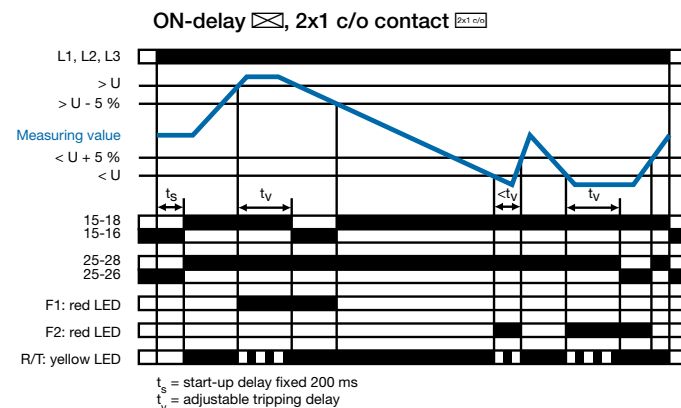

Three-phase monitoring relays

Function diagrams

Phase unbalance monitoring CM-PAS.xx, CM-MPS.xx, CM-MPN.xx

Applying control supply voltage begins the fixed start-up delay t_s . When t_s is complete and all phases are present with correct voltage and with correct phase sequence, the output relays energize and the yellow LED R/T glows.

Type of tripping delay = ON-delay

If the voltage to be monitored exceeds or falls below the set phase unbalance threshold value, the output relays de-energize after the set tripping delay t_v is complete. The LED R/T flashes during timing and turns off as soon as the output relays de-energize.

6 The output relays re-energize automatically as soon as the voltage returns to the tolerance range, taking into account a fixed hysteresis of 20 % and the LED R/T glows.

Type of tripping delay = OFF-delay

If the voltage to be monitored exceeds or falls below the set phase unbalance threshold value, the output relays de-energize instantaneously and the LED R/T turns off.

As soon as the voltage returns to the tolerance range, taking into account a fixed hysteresis of 20 %, the output relays re-energize automatically after the set tripping delay t_v is complete. The LED R/T flashes during timing and turns steady when timing is complete.

ON-delay ☒

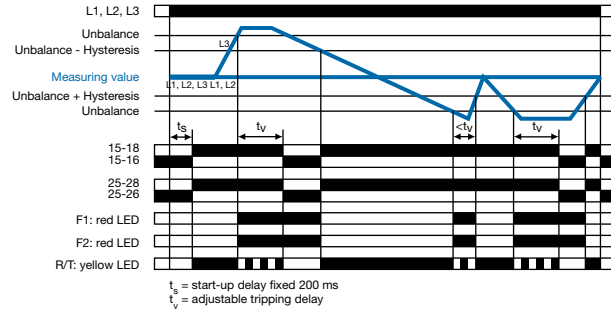

OFF-delay ■

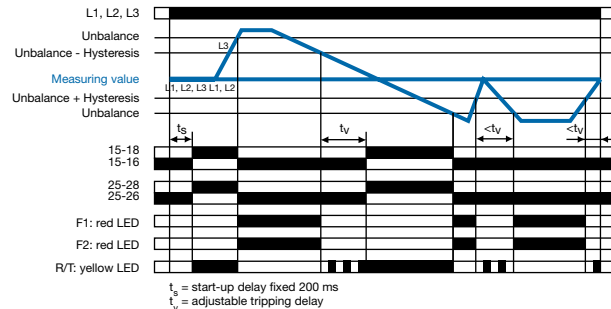

LED functions CM-PSS.xx, CM-PSV.xx, CM-PAS.xx, CM-MPS.xx, CM-MPN.xx

Function	R/T: yellow LED	F1: red LED	F2: red LED
Control supply voltage applied, output relay energized		-	-
Tripping delay t_v active		-	-
Phase failure	-		
Phase sequence	-		
Overvoltage	-		-
Undervoltage	-	-	
Phase unbalance	-		
Interruption of the neutral	-		
Adjustment error ¹⁾			

¹⁾ Possible misadjustments of the front-face operating controls:

Overlapping of the threshold values: An overlapping of the threshold values is given, if the threshold value for overvoltage is set to a smaller value than the threshold value for undervoltage.

DIP switch 3 = OFF and DIP switch 4 = ON: Automatic phase sequence correction is activated and selected operating mode is 1x2 c/o contacts

DIP switch 2 and 4 = ON: Phase sequence detection is deactivated and the automatic phase sequence correction is activated

Type of tripping delay CM-PSS.xx, CM-PSV.xx, CM-PAS.xx, CM-MPS.xx, CM-MPN.xx

The type of tripping delay ☒ / ■ can be adjusted via a rotary (CM-PxS.xx) or a DIP switch (CM-MPx.xx).

Switch position ON-delay ☒:

In case of a fault, the de-energizing of the output relays and the respective fault message are suppressed for the adjusted tripping delay t_v .

Switch position OFF-delay ■:

In case of a fault, the output relays de-energize instantaneously and a fault message is displayed and stored for the length of the adjusted tripping delay t_v . Thereby, also momentary undervoltage conditions are recognized.

Three-phase monitoring relays Function diagrams

Grid feeding monitoring CM-UFS.2

Function of the yellow LED

The yellow LED is flashing during timing and turns steady as soon as the output relays are energized.

Phase failure monitoring

Applying control supply voltage begins the fixed start-up delay t_{s1} . When t_{s1} is complete and all phases are present with correct voltage and frequency, the output relays energize. They de-energize instantaneously if a phase failure occurs. The fault is indicated by LEDs.

As soon as all 3 phases are present again, the output relays re-energize automatically after the set restart delay t_{s2} is complete.

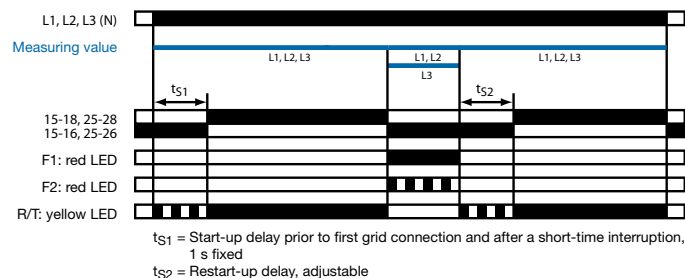

Over- and undervoltage monitoring

Applying control supply voltage begins the fixed start-up delay t_{s1} . When t_{s1} is complete and all phases are present with correct voltage and frequency, the output relays energize.

If the voltage to be monitored exceeds or falls below the fixed threshold value, the output relays de-energize instantaneously. The fault type is indicated by LEDs. As soon as the voltage returns to the tolerance range, taking into account a fixed hysteresis of 5 %, the output relays re-energize after the set restart delay t_{s2} is complete.

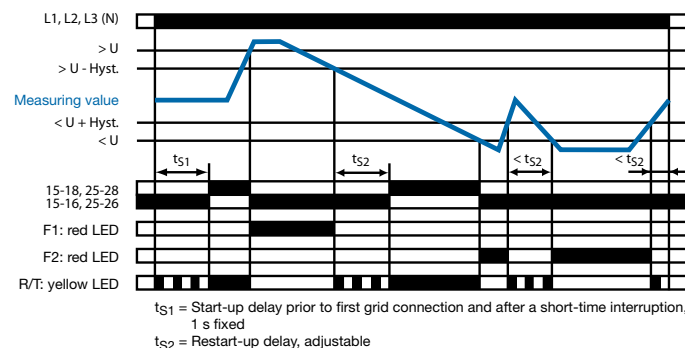

LED Functions

Function	R/T: yellow LED	F1: red LED	F2: red LED
Output relay energized		-	-
Delay active		-	-
Overvoltage	-		-
Undervoltage	-	-	
Overfrequency	-		-
Underfrequency	-	-	
Phase failure	-		

Over- and underfrequency monitoring

Applying control supply voltage begins the fixed start-up delay t_{s1} . When t_{s1} is complete and all phases are present with correct voltage and frequency, the output relays energize.

If the frequency to be monitored exceeds or falls below the fixed threshold value, the output relays deenergize instantaneously. The fault type is indicated by LEDs. As soon as the frequency returns to the tolerance range, taking into account a fixed hysteresis, the output relays re-energize after the set restart delay t_{s2} is complete.

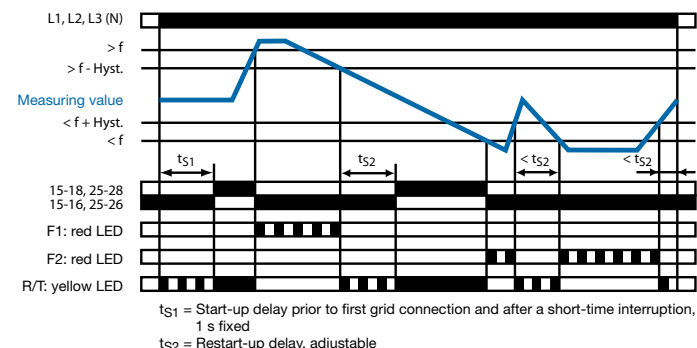

Function diagram legend

- Control supply voltage not applied / Output contact open / LED off
- Control supply voltage applied / Output contact closed / LED glowing

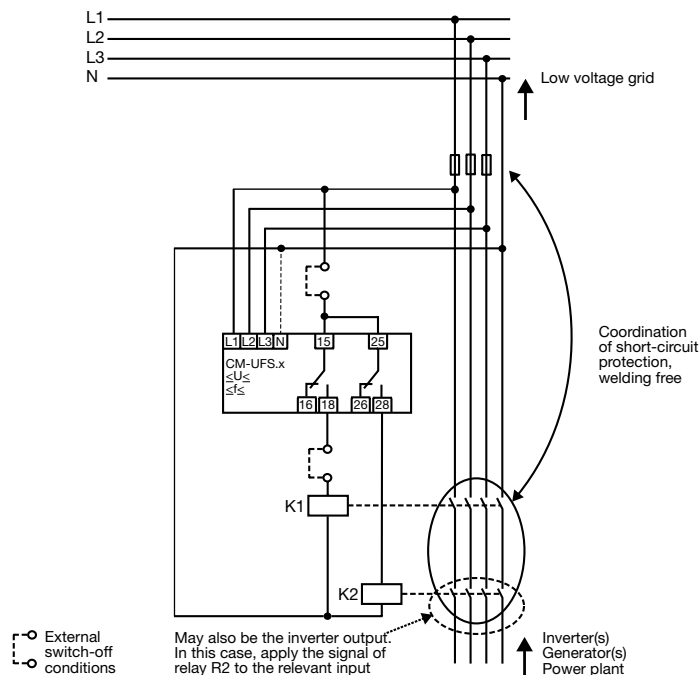

Automatized grid connection instead of a permanently accessible switching point with a disconnection function

Three-phase monitoring relays

Connection diagrams, DIP switches

Connection diagrams CM-PBE

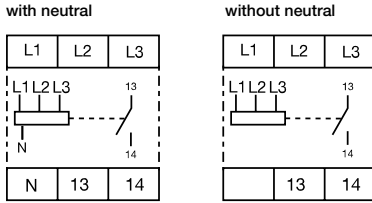

L1, L2, L3, (N) Control supply voltage =
Measuring voltage
13-14 Output contact -
closed-circuit principle

Connection diagram CM-PVS.x1

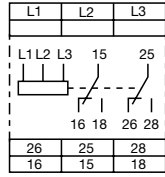

L1, L2, L3 Control supply voltage =
measuring voltage
15-16/18 Output contacts -
25-26/28 closed-circuit principle

Connection diagram CM-PFS

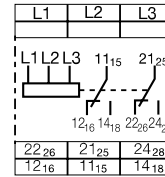

L1-L2-L3 Control supply voltage =
Measuring voltage
11₁₅-12₁₆/14₁₈ Output contact -
21₂₅-22₂₆/24₂₈ Closed-circuit principle

6

Rotary switch "Function" CM-PVS

- ON-delay
with phase sequence monitoring
- OFF-delay
with phase sequence monitoring
- ON-delay
without phase sequence monitoring
- OFF-delay
without phase sequence monitoring

Connection diagrams CM-PVE

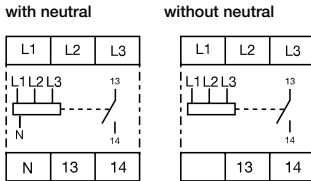

L1, L2, L3, (N) Control supply voltage =
Measuring voltage
13-14 Output contact -
closed-circuit principle

Connection diagram CM-PSS.x1

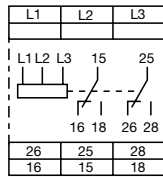

L1, L2, L3 Control supply voltage =
measuring voltage
15-16/18 Output contacts -
25-26/28 closed-circuit principle

Connection diagram CM-PFE

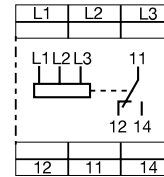

L1-L2-L3 Control supply voltage =
Measuring voltage
11-12/14 Output contact
Closed-circuit principle

Rotary switch "Function" CM-PSS

- ON-delay
with phase sequence monitoring
- OFF-delay
with phase sequence monitoring
- ON-delay
without phase sequence monitoring
- OFF-delay
without phase sequence monitoring

Connection diagram CM-UFS.2

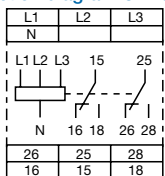

L1, L2, L3, N Control supply voltage =
Measuring voltage
15-16/18 Output contacts -
25-26/28 closed-circuit principle

Connection diagram CM-MPN.x2

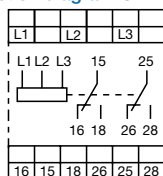

L1, L2, L3 Control supply voltage =
measuring voltage
15-16/18 Output contacts -
25-26/28 closed-circuit principle

Connection diagram CM-PAS.x1

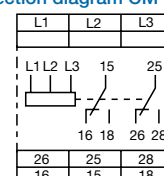

L1, L2, L3 Control supply voltage =
measuring voltage
15-16/18 Output contacts -
25-26/28 closed-circuit principle

Three-phase monitoring relays

Connection diagrams, DIP switches, rotary switches

Connection diagram CM-MPS.x3

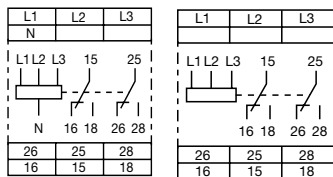

L1, L2, L3, (N) Control supply voltage = measuring voltage
15-16/18 Output contacts - closed-circuit principle
25-26/28

DIP switch functions CM-MPS.x3 and CM-MPN.x2

Position	4	3	2	1
ON ↑		2x1 c/o		
OFF		1x2 c/o		

1 Timing function
ON ON-delayed
OFF OFF-delayed

2 Phase sequence monitoring
ON deactivated
OFF activated

3 Operating principle of output
ON 2x1 c/o contact
OFF 1x2 c/o contacts

4 Phase sequence correction
ON activated
OFF deactivated

¹⁾ Output relay R1 is responsive to overvoltage, output relay R2 is responsive to undervoltage. In case of other faults, both output relays react synchronously.

Connection diagram CM-MPS.x1

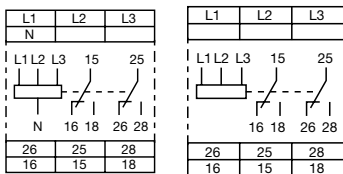

L1, L2, L3, (N) Control supply voltage = measuring voltage
15-16/18 Output contacts - closed-circuit principle
25-26/28

DIP switch functions CM-MPS.x1

Position	2	1
ON ↑		
OFF		

1 Timing function
ON ON-delayed
OFF OFF-delayed

2 Phase sequence monitoring
ON deactivated
OFF activated

Three-phase monitoring relays

Technical data

Data at $T_a = 25\text{ °C}$ and rated values, unless otherwise indicated

Type	CM-PBE ¹⁾	CM-PBE	CM-PVE ¹⁾	CM-PVE	CM-PFE	CM-PFS
Supply circuit = measuring circuit	L1-L2-L3-N	L1-L2-L3	L1-L2-L3-N	L1-L2-L3	L1-L2-L3	
Rated control supply voltage U_s = measuring voltage	3x380-440 V AC, 220-240 V AC	3x380-440 V AC	3x320-460 V AC, 185-265 V AC	3x320-460 V AC	3x208-440 V AC	3x200-500 V AC
Power consumption						approx. 15 VA
Rated control supply voltage U_s tolerance	-15...+15 %		-15...+10 %		-10...+10 %	-15...+10 %
Rated frequency	50/60 Hz		50/60 Hz (-10...+10 %)		50/60 Hz	
Duty time	100 %					
Measuring circuit	L1-L2-L3-N	L1-L2-L3	L1-L2-L3-N	L1-L2-L3	L1-L2-L3	
Monitoring functions	phase failure	■	■	■	■	■
	phase sequence	-	-	-	-	-
	over / undervoltage	-	-	-	-	-
	neutral	■	-	■	-	-
Measuring ranges	3x380-440 V AC, 220-240 V AC	3x380-440 V AC	3x320-460 V AC, 185-265 V AC	3x320-460 V AC	3x208-440 V AC	3x200-500 V AC
Thresholds	U_{min}		fixed 185 V / 320 V	fixed 320 V	$0.6 \times UN$	
	U_{max}		fixed 265 V / 460 V	fixed 460 V		
Hysteresis related to the threshold value	fixed 5 % (release value = $0.65 \times UN$)		fixed 5 %			
Measuring voltage frequency	50/60 Hz (-10 %...+10 %)				50/60 Hz	
Response time	40 ms		80 ms		500 ms	
Accuracy within the rated control supply voltage tolerance						$\Delta U \leq 0.5\ %$
Accuracy within the temperature range						$\Delta U \leq 0.06\ \% / \text{°C}$
Timing circuit						
Start-up delay t_s	fixed 500 ms ($\pm 20\ %$)				fixed 500 ms	
Tripping t_v	fixed 150 ms ($\pm 20\ %$)	at over- / undervoltage fixed 500 ms ($\pm 20\ %$)			fixed 500 ms	-
Indication of operational states						
Relay status	R: yellow LED	 Output relay energized				
Output circuits	13-14				11-12/14	11(15)-12(16)/14(18), 21(25)-22(26)/24(28)
Kind of output	1 n/o contact				1 c/o contact	2 c/o contacts
Operating principle ²⁾	closed-circuit principle					
Contact material	AgCdO				AgNi	
Rated operational voltage U_n	IEC/EN 60947-1		250 V			
Minimum switching voltage / Minimum switching current	- / -					
Maximum switching voltage	250 V AC, 250 V DC					
Rated operational current I_n (IEC/EN 60947-5-1)	AC12 (resistive) 230 V	4 A				
	AC15 (inductive) 230 V	3 A				
	DC12 (resistive) 24 V	4 A				
	DC13 (inductive) 24 V	2 A				
Mechanical lifetime	30 x 10 ⁶ switching cycles					
Electrical lifetime (AC12, 230 V, 4 A)	0.1 x 10 ⁶ switching cycles					
Max. fuse rating to achieve short-circuit protection	n/c contact	10 A fast-acting				4 A fast-acting
	n/o contact	10 A fast-acting				6 A fast-acting
AC rating (UL 508)	Utilization category (Control Circuit Rating Code)	B 300				
	max. rated operational voltage	300 V AC				
	max. continuous thermal current at B 300	5 A				
	max. making/breaking apparent power at B 300	3600/360 VA				

¹⁾ Device with neutral monitoring: The external conductor voltage towards the neutral conductor is measured.

²⁾ Closed-circuit principle: Output relay is de-energized if the measured value exceeds/drops below the adjusted threshold.

Three-phase monitoring relays

Technical data

Measuring &
monitoring relays
CM Range

Data at $T_a = 25\text{ °C}$ and rated values, unless otherwise indicated

Type	CM-PBE ¹⁾	CM-PBE	CM-PVE ¹⁾	CM-PVE	CM-PFE	CM-PFS
General data						
Dimensions (W x H x D)	22.5 x 78 x 78.5 mm (0.89 x 3.07 x 3.09 in)					22.5 x 78 x 100 mm (0.89 x 3.07 x 3.94 in)
Weight	see data sheet					
Mounting	DIN rail (IEC/EN 60715)					
Mounting position	any					
Degree of protection	housing / terminals IP50 / IP20					
Electrical connection						
Wire size	fine-strand with wire end ferrule		2 x 0.75-1.5 mm ² (2 x 18-16 AWG)		2 x 0.75- 2.5 mm ² (2 x 8-14 AWG)	
	fine-strand without wire end ferrule		2 x 1-1.5 mm ² (2 x 18-16 AWG)			
	rigid		2 x 0.75-1.5 mm ² (2 x 18-16 AWG)		2 x 0.5- 4 mm ² (2 x 20-12 AWG)	
Stripping length	10 mm (0.39 in)					7 mm (0.28 in)
Tightening torque	0.6-0.8 Nm					
Environmental data						
Ambient temperature range	operation / storage		-20...+60 °C / -40...+85 °C			
Environmental testing (IEC 68-2-30)	24 h cycle time, 55 °C, 93 % rel., 96 h					
Operational reliability (IEC 68-2-6)	6 g					4 g
Mechanical resistance (IEC 68-2-6)	10 g					6 g
Isolation data						
Rated insulation volt. between supply, measuring and output circuits (VDE 0110, IEC 60947-1)	400 V			500 V		
Rated impulse withstand voltage U_{imp} between all isolated circuits (VDE 0110, IEC 664)	4 kV / 1.2 - 50 μs					
Test voltage between all isolated circuits	2.5 kV, 50 Hz, 1 min.					
Pollution category (VDE 0110, IEC/EN 60664, IEC 255-5)	3					
Overvoltage category (VDE 0110, IEC/EN 60664, IEC 255-5)	III					
Standards						
Product standard	IEC 255-6, EN 60255-6					
Low Voltage Directive	2006/95/EC					
EMC Directive	2004/108/EC					
Electromagnetic compatibility						
Interference immunity to	EN 61000-6-2					
electrostatic discharge	IEC/EN 61000-4-2		Level 3 - 6 kV/ 8 kV			
radiated, radio-frequency, electromagnetic field	IEC/EN 61000-4-3		Level 3 - 10 V/m			
electrical fast transient / burst	IEC/EN 61000-4-4		Level 3 - 2 kV / 5 kHz			
surge	IEC/EN 61000-4-5		Level 4 - 2 kV-L			
conducted disturbances, induced by radio-frequency fields	IEC/EN 61000-4-6		Level 3 - 10 V			
Interference emission	EN 61000-6-4					

¹⁾ Device with neutral monitoring: The external conductor voltage towards the neutral conductor is measured.

²⁾ Closed-circuit principle: Output relay is de-energized if the measured value exceeds/drops below the adjusted threshold.

Three-phase monitoring relays

Technical data

Data at $T_a = 25\text{ °C}$ and rated values, unless otherwise indicated

Type	CM-PSS.31	CM-PSS.41	CM-PVS.31	CM-PVS.41	CM-PVS.81	CM-PAS.31	CM-PAS.41
Input circuit = Measuring circuit				L1, L2, L3			
Rated control supply voltage $U_s =$ measuring voltage	3x380 V AC	3x400 V AC	3x160-300 V AC	3x300-500 V AC	3x200-400 V AC	3x160-300 V AC	3x300-500 V AC
Rated control supply voltage U_s tolerance				-15...+10 %			
Rated frequency				50/60 Hz			
Frequency range				45-65 Hz			
Typical current / power consumption	25 mA / 18 VA (380 V AC)	25 mA / 18 VA (400 V AC)	25 mA / 10 VA (230 V AC)	25 mA / 18 VA (400 V AC)	19 mA / 10 VA (300 V AC)	25 mA / 10 VA (230 V AC)	25 mA / 18 VA (400 V AC)
6 Measuring circuit				L1, L2, L3			
Monitoring functions							
Phase failure	■	■	■	■	■	■	■
Phase sequence			can be switched off			■	■
Automatic phase sequence correction	-	-	-	-	-	-	-
Over- / undervoltage	■	■	■	■	■	-	-
Phase unbalance	-	-	-	-	-	■	■
Neutral	-	-	-	-	-	-	-
Measuring range							
Overvoltage	3x418 V AC	3x440 V AC	3x220-300 V AC	3x420-500 V AC	3x300-400 V AC	-	-
Undervoltage	3x342 V AC	3x360 V AC	3x160-230 V AC	3x300-380 V AC	3x210-300 V AC	-	-
Phase unbalance	-	-	-	-	-	2-25 % of average of phase voltages	
Thresholds							
Overvoltage		fixed	adjustable within measuring range			-	-
Undervoltage		fixed	adjustable within measuring range			-	-
Phase unbalance (switch-off value)	-	-	-	-	-	adjust. within meas. range	
Hysteresis related to the threshold value			fixed 5 %			-	fixed 20 %
Phase unbalance	-	-	-	-	-	-	-
Rated frequency of the measuring signal				50/60 Hz			
Frequency range of the measuring signal				45-65 Hz			
Maximum measuring cycle time				100 ms			
Accuracy within the rated control supply voltage tolerance				$\Delta U \leq 0.5\%$			
Accuracy within the temperature range				$\Delta U \leq 0.06\% / \text{°C}$			
Measuring method				True RMS			
Timing circuit							
Start-up delay t_s				fixed 200 ms			
Tripping delay t_v				ON- or OFF-delay 0; 0.1-30 s adjustable		ON- delay 0; 0.1-30 s adjustable	
Repeat accuracy (constant parameters)	-	-	-	-	1 w 0.2 %	-	-
Accuracy within the rated control supply voltage tolerance				$\Delta t \leq 0.5\%$			
Accuracy within the temperature range				$\Delta t \leq 0.06\% / \text{°C}$			
Indication of operational states				1 yellow LED, 2 red LED's			
	Details see function description / -diagrams		Details see operating mode and function description / -diagrams			Details see function description / -diagrams	
Output circuits							
Kind of output				15-16/18, 25-26/28			
Operating principle ¹⁾				2x1 c/o contacts (Relays)			
Contact material				closed-circuit principle			
Rated operational voltage U_a	IEC/EN 60947-1			AgNi alloy, Cd free			
Minimum switching power				250 V			
Maximum switching voltage				24 V / 10 mA			
				see load limit curve			

¹⁾ Closed-circuit principle: Output relay(s) de-energize(s) if measured value exceeds or falls below the adjusted threshold value

Three-phase monitoring relays

Technical data

Data at $T_a = 25\text{ °C}$ and rated values, unless otherwise indicated

Type	CM-PSS.31	CM-PSS.41	CM-PVS.31	CM-PVS.41	CM-PVS.81	CM-PAS.31	CM-PAS.41
Rated operational current I_o (IEC/EN 60947-5-1)	AC12 (resistive) 230 V				4 A		
	AC15 (inductive) 230 V				3 A		
	DC12 (resistive) 24 V				4 A		
	DC13 (inductive) 24 V				2 A		
	Utilization category (Control Circuit Rating Code)				B 300		
AC rating (UL 508)					300 V AC		
max. rated operational voltage					300 V AC		
max. continuous thermal current at B 300					5 A		
max. making/breaking apparent power at B 300					3600/360 VA		
Mechanical lifetime					30 x 10 ⁶ switching cycles		
Electrical lifetime (AC12, 230 V, 4 A)					0.1 x 10 ⁶ switching cycles		
Max. fuse rating to achieve short-circuit protection		n/c contact n/o contact			6 A fast-acting 10 A fast-acting		
General data ¹⁾							
MTBF					on request		
Duty time					100%		
Dimensions (W x H x D)	product dimensions				22.5 x 85.6 x 103.7 mm (0.89 x 3.37 x 4.08 in)		
	packaging dimensions				97 x 109 x 30 mm (3.82 x 4.29 x 1.18 in)		
Weight					depending on device, see ordering details		
Mounting					DIN rail (IEC/EN 60715), snap-on mounting without any tool		
Mounting position					any		
Minimum distance to other units	vertical / horizontal				not necessary / not necessary		
Material of housing					UL 94 V-0		
Degree of protection	housing / terminals				IP50 / IP20		
Electrical connection ¹⁾							
Wire size		Screw connection technology		Easy Connect Technology (Push-in)			
fine-strand with(out) wire end ferrule		1 x 0.5-2.5 mm ² (1 x 20-14 AWG)		2 x 0.5-1.5 mm ² (2 x 20-16 AWG)			
		2 x 0.5-1.5 mm ² (2 x 20-16 AWG)					
	rigid	1 x 0.5-4 mm ² (1 x 20-12 AWG)		2 x 0.5-1.5 mm ² (2 x 20-16 AWG)			
		2 x 0.5-2.5 mm ² (2 x 20-14 AWG)					
Stripping length				8 mm (0.32 in)			
Tightening torque		0.6-0.8 Nm (5.31-7.08 lb.in)					
Environmental data							
Ambient temperature ranges	operation / storage			-25...+60 °C / -40...+85 °C			
Damp heat (IEC 60068-2-30)				55 °C, 6 cycles			
Climatic category				3K3			
Vibration (sinusoidal) (IEC/EN 60255-21-1)				Class 2			
Shock (IEC/EN 60255-21-2)				Class 2			
Isolation data ¹⁾							
Rated insulation voltage U	input circuit / output circuit			600 V			
	output circuit 1 / output circuit 2			300 V			
Rated impulse withstand voltage U _{imp} (VDE 0110, IEC/EN 60664)	input circuit			6 kV; 1.2/50 μs			
	output circuit			4 kV; 1.2/50 μs			
Test voltage between all isolated circuits (type test)				2.5 kV, 50 Hz, 1 s			
Basis isolation	input circuit / output circuit			600 V			
Protective separation (VDE 0106 part 101 and 101/A, IEC/EN 1140)	input circuit / output circuit			-			
Pollution degree (VDE 0110, IEC/EN 60664)				3			
Overvoltage category (VDE 0110, IEC 60664)				III			
Standards							
Product standard				IEC/EN 60255-6, EN 50178			
Low Voltage Directive				2006/95/EG			
EMC directive				2004/108/EG			
RoHS directive				2002/95/EG			
Electromagnetic compatibility							
Interference immunity to				EN 61000-6-1, EN 61000-6-2			
electrostatic discharge	IEC/EN 61000-4-2			Level 3 (6 kV / 8 kV)			
radiated, radio-frequency, electromagnetic field	IEC/EN 61000-4-3			Level 3 (10 V/m)			
electrical fast transient / burst	IEC/EN 61000-4-4			Level 3 (2 kV / 2 kHz)			
surge	IEC/EN 61000-4-5			Level 4 (2 kV L-L)			
conducted disturbances, induced by radio-frequency fields	IEC/EN 61000-4-6			Level 3 (10 V)			
Interference emission				Class 3			
high-frequency radiated	IEC/CISPR 22, EN 50022			EN 61000-6-3, EN 61000-6-4			
high-frequency conducted	IEC/CISPR 22, EN 50022			Class B			

¹⁾ Data for devices 1SVR 730 xxx xxx, 1SVR 740 xxx xxx, 1SVR 750 xxx xxx, 1SVR 760 xxx xxx. For devices 1SVR x30 xxx xxx, 1SVR x50 xxx xxx refer to the data sheet.

Three-phase monitoring relays

Technical data

Data at $T_a = 25\text{ °C}$ and rated values, unless otherwise indicated

Type	CM-MPS.11	CM-MPS.21	CM-MPS.31	CM-MPS.41
Input circuit = Measuring circuit	L1, L2, L3, N		L1, L2, L3	
Rated control supply voltage U_s = measuring voltage	3x90-170 V AC	3x180-280 V AC	3x160-300 V AC	3x300-500 V AC
Rated control supply voltage U_s tolerance	-15...+10 %			
Rated frequency	50/60 Hz			
Frequency range	45-65 Hz			
Typical current / power consumption	25 mA / 10 VA (115 V AC)	25 mA / 18 VA (230 V AC)	25 mA / 10 VA (230 V AC)	25 mA / 18 VA (400 V AC)
6 Measuring circuit	L1, L2, L3, N		L1, L2, L3	
Monitoring functions	Phase failure Phase sequence Automatic phase sequence correction	Phase failure Phase sequence Automatic phase sequence correction	Phase failure Phase sequence Automatic phase sequence correction	Phase failure Phase sequence Automatic phase sequence correction
	■ - -	■ - -	■ - -	■ - -
	can be switched off			
	Over- / undervoltage Phase unbalance Interrupted neutral	Over- / undervoltage Phase unbalance Interrupted neutral	Over- / undervoltage Phase unbalance Interrupted neutral	Over- / undervoltage Phase unbalance Interrupted neutral
	■ ■ ■	■ ■ ■	■ ■ ■	■ ■ ■
Measuring range	Overvoltage Undervoltage	Overvoltage Undervoltage	Overvoltage Undervoltage	Overvoltage Undervoltage
	3x120-170 V AC 3x90-130 V AC	3x240-280 V AC 3x180-220 V AC	3x220-300 V AC 3x160-230 V AC	3x420-500 V AC 3x300-380 V AC
Thresholds	Overvoltage Undervoltage Phase unbalance (switch-off value)	Overvoltage Undervoltage Phase unbalance (switch-off value)	Overvoltage Undervoltage Phase unbalance (switch-off value)	Overvoltage Undervoltage Phase unbalance (switch-off value)
	2-25 % of average of phase voltages adjustable within measuring range adjustable within measuring range adjustable within measuring range			
Hysteresis related to the threshold value	Over- / undervoltage Phase unbalance	Over- / undervoltage Phase unbalance	Over- / undervoltage Phase unbalance	Over- / undervoltage Phase unbalance
	fixed 5 % fixed 20 %			
Rated frequency of the measuring signal	50/60 Hz			
Frequency range of the measuring signal	45-65 Hz			
Maximum measuring cycle time	100 ms			
Accuracy within the rated control supply voltage tolerance	$\Delta U \leq 0.5\%$			
Accuracy within the temperature range	$\Delta U \leq 0.06\% / \text{°C}$			
Measuring method	True RMS			
Timing circuit	fixed 200 ms			
Start-up delay t_s	fixed 200 ms			
Tripping delay t_v	ON- or OFF-delay 0; 0.1-30 s adjustable			
Accuracy within the rated control supply voltage tolerance	$\Delta t \leq 0.5\%$			
Accuracy within the temperature range	$\Delta t \leq 0.06\% / \text{°C}$			
Indication of operational states	Details see function description / -diagrams			
Output circuits	15-16/18, 25-26/28			
Kind of output	1x2 c/o contacts (Relays)			
Operating principle ¹⁾	closed-circuit principle			
Contact material	AgNi alloy, Cd free			
Rated operational voltage U_o (IEC/EN 60947-1)	250 V			
Minimum switching power	24 V / 10 mA			
Maximum switching voltage	see load limit curve			
Rated operational current I_o (IEC/EN 60947-5-1)	AC12 (resistive) 230 V AC15 (inductive) 230 V DC12 (resistive) 24 V DC13 (inductive) 24 V	AC12 (resistive) 230 V AC15 (inductive) 230 V DC12 (resistive) 24 V DC13 (inductive) 24 V	AC12 (resistive) 230 V AC15 (inductive) 230 V DC12 (resistive) 24 V DC13 (inductive) 24 V	AC12 (resistive) 230 V AC15 (inductive) 230 V DC12 (resistive) 24 V DC13 (inductive) 24 V
	4 A 3 A 4 A 2 A			
AC rating (UL 508)	Utilization category (Control Circuit Rating Code)			
	B 300			
	max. rated operational voltage			
	300 V AC			
	max. continuous thermal current at B 300			
	5 A			
	max. making/breaking apparent power at B 300			
	3600/360 VA			
Mechanical lifetime	30 x 10 ⁶ switching cycles			
Electrical lifetime (AC12, 230 V, 4 A)	0,1 x 10 ⁶ switching cycles			
Max. fuse rating to achieve short-circuit protection	n/c contact n/o contact	n/c contact n/o contact	n/c contact n/o contact	n/c contact n/o contact
	6 A fast-acting 10 A fast-acting			

Three-phase monitoring relays

Technical data

Data at $T_a = 25\text{ °C}$ and rated values, unless otherwise indicated

Type		CM-MPS.11	CM-MPS.21	CM-MPS.31	CM-MPS.41
General data ²⁾					
MTBF		on request			
Duty time		100%			
Dimensions	product dimensions	22.5 x 85.6 x 103.7 mm (0.89 x 3.37 x 4.08 in)			
	packaging dimensions	97 x 109 x 30 mm (3.82 x 4.29 x 1.18 in)			
(W x H x D)					
Weight		Screw connection technology	Easy Connect Technology (Push-in)		
	net weight	depending on device, see ordering details			
	gross weight	depending on device, see ordering details			
Mounting		DIN rail (IEC/EN 60715), snap-on mounting without any tool			
Mounting position		any			
Minimum distance to other units	vertical / horizontal	not necessary / not necessary			
Material of housing		UL 94 V-0			
Degree of protection	housing / terminals	IP50 / IP20			
Electrical connection ²⁾					
Wire size		Screw connection technology	Easy Connect Technology (Push-in)		
	fine-strand with(out) wire end ferrule	1 x 0.5-2.5 mm ² (1 x 20-14 AWG) 2 x 0.5-1.5 mm ² (2 x 20-16 AWG)	2 x 0.5-1.5 mm ² (2 x 20-16 AWG)		
	rigid	1 x 0.5-4 mm ² (1 x 20-12 AWG) 2 x 0.5-2.5 mm ² (2 x 20-14 AWG)	2 x 0.5-1.5 mm ² (2 x 20-16 AWG)		
Stripping length		8 mm (0.32 in)			
Tightening torque		0.6-0.8 Nm (5.31-7.08 lb.in)		-	
Environmental data					
Ambient temperature ranges	operation / storage	-25...+60 °C / -40...+85 °C			
Damp heat (IEC 60068-2-30)		55 °C, 6 cycles			
Climatic category		3K3			
Vibration (sinusoidal) (IEC/EN 60255-21-1)		Class 2			
Shock (IEC/EN 60255-21-2)		Class 2			
Isolation data ²⁾					
Rated insulation voltage U_i	input circuit / output circuit	600 V			
	output circuit 1 / output circuit 2	300 V			
Rated impulse withstand voltage U_{imp} (VDE 0110, IEC/EN 60664)	input circuit	6 kV; 1.2/50 μ s			
	output circuit	4 kV; 1.2/50 μ s			
Test voltage between all isolated circuits (type test)		2.5 kV, 50 Hz, 1 s			
Basis isolation	input circuit / output circuit	600 V			
Protective separation (VDE 0106 part 101 and 101/A, IEC/EN 61140)	input circuit / output circuit	yes	-		
Pollution degree (VDE 0110, IEC/EN 60664)		3			
Overvoltage category (VDE 0110, IEC 60664)		III			
Standards ²⁾					
Product standard		IEC/EN 60255-6, EN 50178			
Low Voltage Directive		2006/95/EG			
EMC directive		2004/108/EG			
RoHS directive		2002/95/EG			
Electromagnetic compatibility					
Interference immunity to		EN 61000-6-1, EN 61000-6-2			
electrostatic discharge	IEC/EN 61000-4-2	Level 3 (6 kV / 8 kV)			
radiated, radio-frequency, electromagnetic field	IEC/EN 61000-4-3	Level 3 (10 V/m)			
electrical fast transient / burst	IEC/EN 61000-4-4	Level 3 (2 kV / 2 kHz)			
surge	IEC/EN 61000-4-5	Level 4 (2 kV L-L)			
conducted disturbances, induced by radio-frequency fields	IEC/EN 61000-4-6	Level 3 (10 V)			
harmonics and interharmonics	IEC/EN 61000-4-13	Class 3			
Interference emission		EN 61000-6-3, EN 61000-6-4			
high-frequency radiated	IEC/CISPR 22, EN 50022	Class B			
high-frequency conducted	IEC/CISPR 22, EN 50022	Class B			

¹⁾ Closed-circuit principle: Output relay(s) de-energize(s) if measured value exceeds or falls below the adjusted threshold value

²⁾ Data for devices 1SVR 730 xxx xxx, 1SVR 740 xxx xxx, 1SVR 750 xxx xxx, 1SVR 760 xxx xxx. For devices 1SVR x30 xxx xxx, 1SVR x50 xxx xxx refer to the data sheet.

Three-phase monitoring relays

Technical data

Data at $T_a = 25\text{ °C}$ and rated values, unless otherwise indicated

Type	CM-MPS.23	CM-MPS.43	CM-MPN.52	CM-MPN.62	CM-MPN.72
Input circuit = Measuring circuit					
Rated control supply voltage $U_s =$ measuring voltage	L1, L2, L3, N 3x180-280 V AC	3x300-500 V AC	L1, L2, L3 3x350-580 V AC 3x450-720 V AC 3x530-820 V AC		
Rated control supply voltage U_s tolerance	-15...+10 %				
Rated frequency	50/60/400 Hz 45-440 Hz		50/60 Hz 45-65 Hz		
Frequency range	5 mA / 4 VA (230 V AC)		5 mA / 4 VA (400 V AC)	29 mA / 41 VA (480 V AC)	29 mA / 52 VA (600 V AC)
Typical current / power consumption			29 mA / 59 VA (690 V AC)		
6 Measuring circuit					
Monitoring functions	L1, L2, L3, N	L1, L2, L3			
Phase failure	■	■	■	■	■
Phase sequence		can be switched off			■
Automatic phase sequence correction		configurable			
Over- / undervoltage	■	■	■	■	■
Phase unbalance	■	■	■	■	■
Interrupted neutral	■	-	-	-	-
Measuring range	Overvoltage 3x240-280 V AC	3x420-500 V AC	3x480-580 V AC	3x600-720 V AC	3x690-820 V AC
	Undervoltage 3x180-220 V AC	3x300-380 V AC	3x350-460 V AC	3x450-570 V AC	3x530-660 V AC
Thresholds	Phase unbalance	2-25 % of average of phase voltages			
	Overvoltage	adjustable within measuring range			
	Undervoltage	adjustable within measuring range			
	Phase unbalance (switch-off value)	adjustable within measuring range			
Hysteresis related to the threshold value	Over- / undervoltage	fixed 5 %			
	Phase unbalance	fixed 20 %			
Rated frequency of the measuring signal	50/60/400 Hz		50/60 Hz		
Frequency range of the measuring signal	45-440 Hz		45-65 Hz		
Maximum measuring cycle time	100 ms				
Accuracy within the rated control supply voltage tolerance	$\Delta U \leq 0.5\%$				
Accuracy within the temperature range	$\Delta U \leq 0.06\% / \text{°C}$				
Measuring method	True RMS				
Timing circuit					
Start-up delay t_s and t_{s2}	fixed 200 ms				
Start-up delay t_{s1}	fixed 250 ms				
Tripping delay t_v	ON- or OFF-delay 0; 0.1-30 s adjustable		ON-delay 0; 0.1-30 s adjustable		
Accuracy within the rated control supply voltage tolerance	$\Delta t \leq 0.5\%$				
Accuracy within the temperature range	$\Delta t \leq 0.06\% / \text{°C}$				
Indication of operational states	Details see function description / -diagrams				
Output circuits					
Kind of output	15-16/18, 25-26/28 2x1 or 1x2 c/o contacts configurable (Relays)				
Operating principle ¹⁾	closed-circuit principle				
Contact material	AgNi alloy, Cd free				
Rated operational voltage U_o	IEC/EN 60947-1 250 V				
Minimum switching power	24 V / 10 mA				
Maximum switching voltage	see load limit curve				
Rated operational current I_o (IEC/EN 60947-5-1)	AC12 (resistive) 230 V	4 A			
	AC15 (inductive) 230 V	3 A			
	DC12 (resistive) 24 V	4 A			
	DC13 (inductive) 24 V	2 A			
AC rating (UL 508)	Utilization category (Control Circuit Rating Code)	B 300			
	max. rated operational voltage	300 V AC			
	max. continuous thermal current at B 300	5 A			
	max. making/breaking apparent power at B 300	3600/360 VA			
Mechanical lifetime	30 x 10 ⁶ switching cycles				
Electrical lifetime (AC12, 230 V, 4 A)	0,1 x 10 ⁶ switching cycles				
Max. fuse rating to achieve short-circuit protection	n/c contact	6 A fast-acting	10 A fast-acting		
	n/o contact	10 A fast-acting			

¹⁾ Closed-circuit principle: Output relay(s) de-energize(s) if measured value exceeds or falls below the adjusted threshold value

Three-phase monitoring relays

Technical data

Data at $T_a = 25\text{ °C}$ and rated values, unless otherwise indicated

Type	CM-MPS.23	CM-MPS.43	CM-MPN.52	CM-MPN.62	CM-MPN.72
General data ²⁾					
MTBF	on request				
Duty time	100%				
Dimensions (W x H x D)	product dimensions	22.5 x 85.6 x 103.7 mm (0.89 x 3.37 x 4.08 in)			
	packaging dimensions	97 x 109 x 30 mm (3.82 x 4.29 x 1.18 in)			
Weight	depending on device, see ordering details				
Mounting	DIN rail (IEC/EN 60715), snap-on mounting without any tool				
Mounting position	any				
Minimum distance to other units	vertical / horizontal	not necessary / not necessary			
Material of housing	UL 94 V-0				
Degree of protection	housing / terminals	IP50 / IP20			
Electrical connection ²⁾					
Wire size	fine-strand with(out) wire end ferrule	Screw connection technology		Easy Connect Technology (Push-in)	
		1 x 0.5-2.5 mm ² (1 x 20-14 AWG) 2 x 0.5-1.5 mm ² (2 x 20-16 AWG)		2 x 0.5-1.5 mm ² (2 x 20-16 AWG)	
	rigid	1 x 0.5-4 mm ² (1 x 20-12 AWG) 2 x 0.5-2.5 mm ² (2 x 20-14 AWG)		2 x 0.5-1.5 mm ² (2 x 20-16 AWG)	
Stripping length	8 mm (0.32 in)				
Tightening torque	0.6-0.8 Nm (5.31-7.08 lb.in)				
Environmental data					
Ambient temperature ranges	operation / storage	-25...+60 °C / -40...+85 °C			
Damp heat (IEC 60068-2-30)	55 °C, 6 cycles				
Climatic category	3K3				
Vibration (sinusoidal) (IEC/EN 60255-21-1)	Class 2				
Shock (IEC/EN 60255-21-2)	Class 2				
Isolation data ²⁾					
Rated insulation voltage U_i	input circuit / output circuit	600 V	1000 V		
	output circuit 1 / 2	300 V			
Rated impulse withstand voltage U_{imp} (VDE 0110, IEC/EN 60664)	input circuit	6 kV; 1.2/50 μ s	8 kV; 1.2/50 μ s		
	output circuit	4 kV; 1.2/50 μ s			
Test voltage (type test) between	isolated output circuits	2.5 kV, 50 Hz, 1 s			
	input circuit and isolated output circuits	2.5 kV, 50 Hz, 1 s	4 kV, 50 Hz, 1 s		
Basis isolation	input circuit / output circuit	600 V	1000 V		
Protective separation (VDE 0106 part 101 and 101/A, IEC/EN 61140)	input circuit / output circuit	-			
Pollution degree (VDE 0110, IEC/EN 60664)	3				
Overvoltage category (VDE 0110, IEC 60664)	III				
Standards ²⁾					
Product standard	IEC/EN 60255-6, EN 50178				
Low Voltage Directive	2006/95/EG				
EMC directive	2004/108/EG				
RoHS directive	2002/95/EG				
Electromagnetic compatibility					
Interference immunity to		EN 61000-6-1, EN 61000-6-2			
electrostatic discharge	IEC/EN 61000-4-2	Level 3 (6 kV / 8 kV)			
radiated, radio-frequency, electromagnetic field	IEC/EN 61000-4-3	Level 3 (10 V/m)			
electrical fast transient / burst surge	IEC/EN 61000-4-4	Level 3 (2 kV / 2 kHz)			
	IEC/EN 61000-4-5	Level 4 (2 kV L-N)	Level 4 (2 kV L-L)		
conducted disturbances, induced by radio-frequency fields	IEC/EN 61000-4-6	Level 3 (10 V)			
harmonics and interharmonics	IEC/EN 61000-4-13	Class 3			
Interference emission		EN 61000-6-3, EN 61000-6-4			
high-frequency radiated	IEC/CISPR 22, EN 50022	Class B			
high-frequency conducted	IEC/CISPR 22, EN 50022	Class B			

²⁾ Data for devices 1SVR 730 xxx xxx, 1SVR 740 xxx xxx, 1SVR 750 xxx xxx, 1SVR 760 xxx xxx. For devices 1SVR x30 xxx xxx, 1SVR x50 xxx xxx refer to the data sheet.

Three-phase monitoring relays

Technical data

Data at $T_a = 25\text{ °C}$ and rated values, unless otherwise indicated

Type	CM-UFS.2	
Input circuit - Measuring circuit	L1, L2, L3	L-N
Rated control supply voltage $U_s =$ measuring voltage	3 x 400 V AC	3 x 230 V AC
Rated control supply voltage tolerance U_s	-20...+20 %	
Control supply voltage range	3 x 300-500 V AC	3 x 180-280 V AC
Rated frequency	50 Hz	
Frequency range	45-55 Hz	
Typical current / power consumption	23 mA / 16 VA	
Power failure buffering time	min. 20 ms	
6 Input circuit - measuring circuit	L1, L2, L3	L-N
Monitoring functions	<ul style="list-style-type: none"> Phase failure Over-/ undervoltage Over-/ underfrequency 10 minutes average value 	
Measuring range	Voltage range 3 x 320-480 V AC	3 x 184-276 V AC
Thresholds	Frequency range	45-55 Hz
	Overvoltage	fix, 120 % of U_s
	Undervoltage	fix, 80 % of U_s
	Overfrequency	50,3 or 51 Hz, configurable
	Underfrequency	49,7 or 49 Hz, configurable
Hysteresis related to the threshold value	Over-/ undervoltage	fix 5 %
	Over-/ underfrequency	fix 20 mHz
Rated frequency of the measuring signal	50 Hz	
Frequency range of the measuring signal	45-55 Hz	
Maximum measuring cycle time	50 ms	
Maximum reaction time (time between fault detection and change of switching status of the relay)	Over-/ undervoltage	< 120 ms
	Over-/ underfrequency	< 100 ms
	10 minutes average value	-
Accuracy within the rated control supply voltage tolerance	$\Delta U \leq 0,5\%$	
Accuracy within the temperature range	$\Delta U \leq 0,06\% / \text{°C}$	
Measuring method	True RMS	
Timing circuit		
Start-up delay t_{s1} prior to grid connection after a short interruption	fix, 1 s	
Restart delay t_{s2}	adjustable, 0 s; 0,1 – 30 s	
Accuracy within the rated control supply voltage tolerance	$\Delta t \leq 0,5\%$	
Accuracy within the temperature range	$\Delta t \leq 0,06\% / \text{°C}$	
Indication of operational states	1 yellow LED, 2 red LEDs Details see operation mode and function description/diagrams	
Output circuits	15-16/18, 25-26/28	
Kind of output	Relais, 1 x 2 changeover	
Operation principle ¹⁾	closed-circuit principle	
Contact material	AgNi alloy, Cd free	
Rated operational voltage U_o (IEC/EN 60947-1)	250 V	
Minimum switching voltage / switching current	24 V / 10 mA	
Maximum switching voltage / switching current	see load limit curve	
Rated operational current I_o (IEC/EN 60947-5-1)	AC12 (resistive) 230 V	4 A
	AC15 (inductive) 230 V	3 A
	DC12 (resistive) 24 V	4 A
	DC13 (inductive) 24 V	2 A
Mechanical lifetime	30 x 10 ⁶ switching cycles	
Electrical lifetime (AC12, 230 V, 4 A)	0,1 x 10 ⁶ switching cycles	
Max. fuse rating to achieve short-circuit protection	n/c contact	6 A fast-acting
	n/o contact	10 A fast-acting

Three-phase monitoring relays

Technical data

Data at $T_a = 25\text{ °C}$ and rated values, unless otherwise indicated

Type		CM-UFS.2
General data		
MTBF		on request
Duty time		100%
Dimensions (W x H x D)	product dimensions	22.5 x 78 x 100 mm (0.89 x 3.07 x 3.94 in)
Weight	gross weight	0.140 (0.31)
Mounting		DIN rail (IEC/EN 60715), snap-on mounting without any tool
Mounting position		any
Minimum distance to other units	vertical / horizontal	not necessary / not necessary
Degree of protection	housing / terminals	IP50 / IP20
Electrical connection		
Wire size	fine-strand with(out) wire end ferrule	2 x 0.75 - 2.5 mm ² (2 x 18-14 AWG)
	rigid	2 x 0.5 - 4 mm ² (2 x 20-12 AWG)
Stripping length		7 mm (0.28 in)
Tightening torque		0.6-0.8 Nm (5.31-7.08 lb.in)
Environmental data		
Ambient temperature range	operation / storage	-25...+60 °C / -40...+85 °C
Damp heat, cyclic (IEC/EN 60068-2-30)		2 x 12 h cycle, 55 °C, 95 % RH
Climatic category (IEC/EN 60721-3-1)		3K3
Vibration (sinusoidal) (IEC/EN 60255-21-1)		Class 2
Shock (IEC/EN 60255-21-2)		Class 2
Isolation data		
Rated impulse withstand voltage U_i	input circuit / output circuit	600 V
	output circuit 1 / 2	300 V
Rated impulse withstand voltage U_{imp} (VDE 0110, IEC/EN 60664)	input circuit	6 kV; 1.2/50 μ s
	output circuit	4 kV; 1.2/50 μ s
Test voltage between all isolated circuits (type test)		2.5 kV, 50 Hz, 1 s
Basis isolation	input circuit / output circuit	600 V
Protective separation (VDE 0160 Part 101 and 101/A, IEC/EN 61140)	input circuit / output circuit	yes
Pollution degree (VDE 0110, IEC/EN 60664)		3
Overvoltage category (VDE 0110, IEC 60664)		III
Standards		
Product standard	Type-tested in accordance with the "Guideline for Connections to ENEL distribution network" Ed.2.1., January 2011	
Further standards	EN 50178, EN 61727	
Low Voltage Directive	2006/95/EG	
EMV-Directive	2004/108/EG	
RoHS-Directive	2002/95/EG	
Electromagnetic compatibility		
Interference immunity to	IEC/EN 61000-6-1, IEC/EN 61000-6-2	
electrostatic discharge	IEC/EN 61000-4-2	Level 3 (6 kV / 8 kV)
radiated, radio-frequency, electromagnetic field	IEC/EN 61000-4-3	Level 3 (10 V/m)
electrical fast transient / burst	IEC/EN 61000-4-4	Level 3 (2 kV / 2 kHz)
surge	IEC/EN 61000-4-5	Level 4 (2 kV L-L, L-N)
conducted disturbances, induced by radio-frequency fields	IEC/EN 61000-4-6	Level 3 (10 V)
harmonics and interharmonics	IEC/EN 61000-4-13	Class 3
Interference emission	IEC/EN 61000-6-3, IEC/EN 61000-6-4	
high-frequency radiated	IEC/CISPR 22, EN 50022	Class B
high-frequency conducted	IEC/CISPR 22, EN 50022	Class B

¹⁾ Closed-circuit principle: Output relay(s) de-energize(s) if measured value exceeds or falls below the adjusted threshold value

Notes



Insulation monitoring relays
for unearthed supply systems

CM-E Range Insulation monitoring relays



Insulation monitoring relays for unearthed supply systems

Benefits and advantages

6



Insulation monitoring relays for unearthed pure AC systems: Characteristics

- For monitoring the insulation resistance of unearthed IT system: up to $U_n = 400$ V AC
- According to IEC/EN 61227-8 "Electrical safety in low voltage distribution systems up to 1000 V AC and 1500 V DC – Equipment for testing, measuring or monitoring of protective measures – Part 8: Insulation monitoring devices for IT systems"
- Rated control supply voltage 24–240 V AC/DC
- Superimposed DC signal
- One measuring range 1–100 kW
- Precise adjustment of the threshold value in 1 kW steps
- Interrupted wire detection
- Fault storage/latching configurable by control input
- 1 c/o contact, closed-circuit principle
- 22.5 mm [0.89 in] width
- 3 LEDs for status indication

A new generation of insulation monitoring relays of the CM range consolidates ABB's strengths in innovative control products.

The new products are in accordance to IEC/EN 61557-1 and to IEC/EN 61557-8. That means the monitoring relays can be used directly to measure the insulation resistance in unearthed AC and DC mains with a voltage up to 690 V AC and 1000 V DC!

With the new prognostic measuring principle the measuring and response time is reduced significantly.

Insulation monitoring relays for unearthed AC, DC or mixed AC/DC systems: Characteristics

- For monitoring the insulation resistance of unearthed IT systems up to $U_n = 250$ V AC and 300 V DC or $U_n = 400$ V AC and 600 V DC
- According to IEC/EN 61227-8 "Electrical safety in low voltage distribution systems up to 1000 V AC and 1500 V DC – Equipment for testing, measuring or monitoring of protective measures – Part 8: Insulation monitoring devices for IT systems"
- Rated control supply voltage 24–240 V AC/DC
- Prognostic measuring principle with superimposed square wave signal
- 1 or 2 measuring ranges (1–100kW or 1–100 kW + 2–200 kOhm)¹⁾
- 1 or 2 (configurable) c/o contacts¹⁾
- Precise adjustment of the measuring value in 1 or 2 kW steps¹⁾
- (non-volatile) fault storage, configurable latching, interrupted wire protection, open- or closed-circuit principle selectable¹⁾
- 22.5 or 45 mm width
- 3 LEDs for status indication
- Solution for solar available

¹⁾ depending on device

Standardization background:

- IEC/EN 61557-1 "Electrical safety in low voltage distribution system up to 1000 V AC and 1500 V DC – Equipment for testing, measuring or monitoring of protective measures – Part 1: General requirements"
- IEC/EN 61557-8 "Electrical safety in low voltage distribution system up to 1000 V AC and 1500 V DC – Equipment for testing, measuring or monitoring of protective measures – Part 1: Insulation monitoring devices for IT systems"

Insulation monitoring relays for unearthed supply systems

Insulation monitoring in IT systems

In electricity supply systems, an earthing system defines the electrical potential of the conductors relative to that of the earth's conductive surface. The choice of earthing system has implications for the safety and electromagnetic compatibility of the power supply. Note that regulations for earthing (grounding) systems vary considerably among different countries.

The international standard IEC 60364 distinguishes three families of earthing arrangements, using the two-letter codes TN, TT and IT.

IT supply systems

The IT system is supplied either by an isolation transformer or a voltage source, such as battery or a generator. In this system no active conductor is directly connected to earth potential. The advantage of this is that only a small fault current can flow in case of an insulation fault. This current is essentially caused by the system's leakage capacitance. The system's fuse or MCB does not respond, thus maintaining the voltage supply and therefore operation even in case of a phase-to-earth fault.

The first letter indicates the connection between earth and the power-supply equipment (generator or transformer):

- T: direct connection of a point with earth (Latin: terra)
- I: no point is connected with earth (insulation), except perhaps via a high impedance

The second letter indicates the connection between earth and the electrical device being supplied:

- T: direct connection of a point with earth
- N: direct connection to neutral at the origin of installation, which is connected to the earth

The high reliability of an IT system is guaranteed thanks to continuous insulation monitoring.

The insulation monitoring device recognizes insulation faults as they develop, and immediately reports that the value has fallen below the minimum. This prevents operational interruptions caused by a second more severe insulation fault.

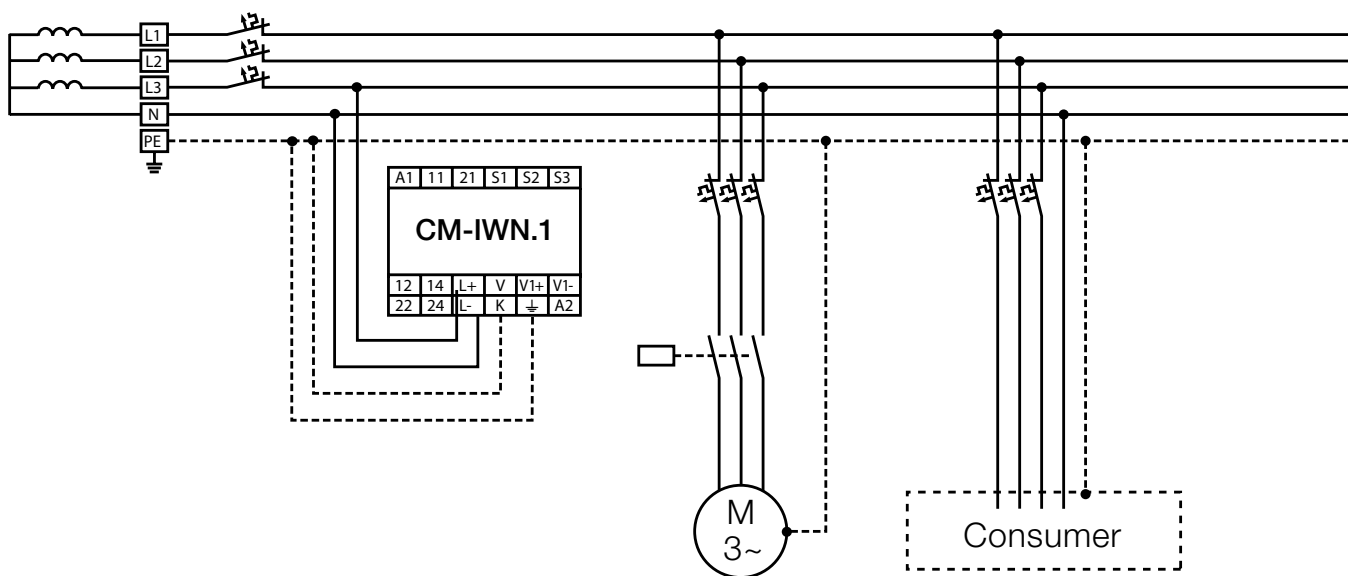

Insulation monitoring relays for unearthed supply systems

Application / monitoring function, measuring principle

Application / monitoring function CM-IWS.2

The CM-IWS.2 serves to monitor insulation resistance in accordance with IEC 61557-8 in unearthed IT AC systems. The insulation resistance between system lines and system earth is measured. If this falls below the adjustable threshold values, the output relay de-energizes. The device can monitor control circuits (single-phase) and main circuits (3-phase). Supply systems with voltages $U_n = 0-400$ V AC (45-65 Hz) can be directly connected to the measuring inputs and their insulation resistance being monitored. For systems with voltages above 400 V AC the insulation monitoring relay CM-IWN.1 with or without the coupling unit CM-IVN can be used.

6

Application / monitoring function CM-IWS.1

The CM-IWS.1 serves to monitor insulation resistance in accordance with IEC 61557-8 in unearthed IT AC systems, IT AC systems with galvanically connected DC circuits, or unearthed IT DC systems. The insulation resistance between system lines and system earth is measured. If this falls below the adjustable threshold value, the output relay de-energizes. The device can monitor control circuits (single-phase) and main circuits (3-phase). Supply systems with voltages $U_n = 0-250$ V AC (15-400 Hz) or 0-300 V DC can be directly connected to the measuring inputs and their insulation resistance being monitored. For systems with voltages above 250 V AC and 300 V DC the insulation monitoring relay CM-IWN.x with or without the coupling unit CM-IVN can be used.

Application / monitoring function CM-IWN.1 / CM-IWN.5

The CM-IWN.x serves to monitor insulation resistance in accordance with IEC 61557-8 in unearthed IT AC systems, IT AC systems with galvanically connected DC circuits, or unearthed IT DC systems. The insulation resistance between system lines and system earth is measured. If this falls below the adjustable threshold values, the output relays switch into the fault state. The device can monitor control circuits (single-phase) and main circuits (3-phase). Supply systems with voltages $U_n = 0-400$ V AC (15-400 Hz) or 0-600 V DC can be directly connected to the measuring inputs and their insulation resistance being monitored. For systems with voltages above 400 V AC and 600 V DC the coupling unit CM-IVN can be used for the expansion of the CM-IWN.x voltage range.

Application / monitoring function CM-IVN

The coupling unit CM-IVN is designed to extend the nominal voltage range of the insulation monitoring relay CM-IWN.1 up to 690 V AC and 1000 V DC. The coupling unit can be connected to the system to be monitored by means of the terminals VL+ and VL-. The terminal V_{\perp} has to be connected to the earth potential. The terminals L+, V1+, L-, V1-, VS and VE have to be connected to the CM-IWN.1 as shown in the connection diagrams below. Supply systems with voltages $U_n = 0-690$ V AC (15-400 Hz) or 0-1000 V DC can be connected.

Measuring principle CM-IWS.2

A superimposed DC measuring signal is used for measurement. From the superimposed DC measuring voltage and its resultant current the value of the insulation resistance of the system to be monitored is calculated.

Measuring principle CM-IWS.1

A pulsating measuring signal is fed into the system to be monitored and the insulation resistance calculated. This pulsating measuring signal alters its form depending on the insulation resistance and system leakage capacitance. From this altered form the change in the insulation resistance is forecast. When the forecast insulation resistance corresponds to the insulation resistance calculated in the next measurement cycle and is smaller than the set threshold value, the output relay de-energizes. This measuring principle is also suitable for the detection of symmetrical insulation faults.

Measuring principle CM-IWN.1 / CM-IWN.5

A pulsating measuring signal is fed into the system to be monitored and the insulation resistance calculated.

This pulsating measuring signal alters its form depending on the insulation resistance and system leakage capacitance. From this altered form the change in the insulation resistance is forecast. When the forecast insulation resistance corresponds to the insulation resistance calculated in the next measurement cycle and is smaller than the set threshold value, the output relays are activated or deactivated, depending on the device configuration. This measuring principle is also suitable for the detection of symmetrical insulation faults.

Measuring principle CM-IVN

With CM-IWN.1 a pulsating measuring signal is fed into the system to be monitored and the insulation resistance calculated. This pulsating measuring signal alters its form depending on the insulation resistance and system leakage capacitance. From this altered form the change in the insulation resistance is forecast. When the forecast insulation resistance corresponds to the insulation resistance calculated in the next measurement cycle and is smaller than the set threshold value, the output relays are activated or deactivated, depending on the device configuration. This measuring principle is also suitable for the detection of symmetrical insulation faults.

Characteristics CM-IWS.2

- For monitoring the insulation resistance of unearthed IT systems up to $U_n = 400$ V AC
- Rated control supply voltage 24-240 V AC/DC
- Measuring principle with superimposed DC voltage
- One measuring range 1-100 k Ω
- Precise adjustment of the threshold value in 1 k Ω steps
- Fault storage / latching configurable by control input
- 1 c/o contact, closed-circuit principle
- 22.5 mm [0.89 in] width
- 3 LEDs for status indication

Characteristics CM-IWS.1

- For monitoring the insulation resistance of unearthed IT systems up to $U_n = 250$ V AC and 300 V DC
- Rated control supply voltage 24-240 V AC/DC
- Prognostic measuring principle with superimposed square wave signal
- One measuring range 1-100 k Ω
- Precise adjustment of the threshold value in 1 k Ω steps
- Interrupted wire detection
- Fault storage / latching configurable by control input
- 1 c/o [SPDT] contact, closed-circuit principle
- 22.5 mm [0.89 in] width
- 3 LEDs for status indication

Characteristics CM-IWN.1, CM-IWN.5

- For monitoring the insulation resistance of unearthed IT systems up to $U_n = 400$ V AC and 600 V DC
- CM-IWN.5: According to IEC/EN 61557-8 "Electrical safety in low voltage distribution systems up to 1000 V a.c. and 1500 V d.c. – Equipment for testing, measuring or monitoring of protective measures – Part 8: Insulation monitoring devices for IT systems"
- Rated control supply voltage 24-240 V AC/DC
- Prognostic measuring principle with superimposed square wave signal
- Two measuring ranges 1-100 k Ω and 2-200 k Ω
- One (1 x 2 c/o) or two (2 x 1 c/o) threshold values $R_{an1}/R1^{1)}$ (final switch-off) and $R_{an2}/R21)$ (prewarning) configurable²⁾
- Precise adjustment of the threshold values in 1 k Ω steps (R1) and 2 k Ω steps (R2)
- Interrupted wire detection configurable
- Non-volatile fault storage configurable
- Open- or closed-circuit principle configurable
- 45 mm (1.77 in) width
- 3 LEDs for status indication

¹⁾ term. acc. to IEC/EN 61557-8

²⁾ R2 only active with 2 x 1 c/o configuration

Characteristics CM-IVN

- Expansion of the nominal voltage range of the insulation monitoring relay CM-IWN.1 for monitoring the insulation resistance of unearthed IT systems up to 690 V AC and 1000 V DC
- According to IEC/EN 61557-8 "Electrical safety in low voltage distribution systems up to 1000 V AC and 1500 V DC – Equipment for testing, measuring or monitoring of protective measures – Part 8: Insulation monitoring devices for IT systems"
- Passive device, no supply voltage needed
- 45 mm [1.77 in] width

Insulation monitoring relays for unearthed supply systems

Selection and conversion table



6

Typical applications

Benefits of ABB's new range of insulation monitoring relays:

- Extended measuring voltage range AC and DC
- All devices with wide supply voltage range
- Reduced number of references
- Optimized solutions for solar applications

	Reference code	Catalog number
	CM-IWS.2	1SVR630670R0200
	CM-IWS.1	1SVR630660R0100
	CM-IWN.1	1SVR650660R0200
	CM-IWN.4	1SVR650660R0300
	CM-IWN.5	1SVR650660R0400
	CM-IWN.6	1SVR650660R0500
	CM-IVN	1SVR650669R9400
Rated control supply voltage U_c		
24 - 240 VAC/DC	■	■
Measuring voltages		
250 V AC (L-PE)		■
400 V AC (L-PE)	■	■
690 V AC		■
300 V DC (L-PE)		■
600 V DC (L-PE)		■
1000 V DC		■
Measuring range		
1 - 100 k Ω	■	■
2 - 200 k Ω		■
Output contacts		
1 c/o	■	■
1 x 2 c/o or 2 x 1 c/o		■
Working principle		
open circuit principle	■	■
open or closed principle adjustable		■
Test		
Front face button or control input		■
Reset		
Front face button or control input		■
Fault storage / latching configurable	■	■
Non voltage storage configurable		■
Interrupted wire detection		■
Threshold values configurable	1	1 2 2 2 2
System leakage capacitance, max.		
10 μ F	■	■
20 μ F		■
500 μ F		■
1000 μ F		■
2000 μ F		■
Coupling unit		
		Yes Yes Yes Yes CM-IWN.1-6

Insulation monitoring relays for unearthed supply systems

Ordering details

Measuring & monitoring relays
CM Range

NEW



CM-IWS.2

Description

The high reliability of an IT system is guaranteed thanks to continuous insulation monitoring. An insulation monitoring device recognizes insulation faults as they develop, and immediately reports that the value has fallen below the minimum. This prevents operational interruption caused by a second, more severe insulation fault.

ABB developed a totally new range of insulation monitors for AC, DC or mixed AC/DC IT Systems up to 690 V AC or 1000 V DC. With only 4 devices most standard applications can be served. Additionally a version for solar applications with increased earth leakage capacitance has been added.



CM-IWS.1



CM-IWN.1



CM-IVN

Ordering details

Rated control supply voltage = measuring voltage	Nominal voltage U_n of the distribution system to be monitored	System leakage capacitance, max.	Adjustment range of the specified response value R_{an} (threshold)	Reference code	Catalog number	Weight (1 pce) kg (lb)
24-240 V AC/DC	0-250 V AC / 0-300 V DC	10 μ F	1-100 kW	CM-IWS.1	1SVR630660R0100	0.133 (0.293)
24-240 V AC/DC	0-400 V AC	10 μ F	1-100 kW	CM-IWS.2	1SVR630670R0200	0.127 (0.280)
24-240 V AC/DC	0-400 V AC / 0-600 V DC	20 μ F	1-100 kW 2-200 kW	CM-IWN.1	1SVR650660R0200	0.231 (0.509)
24-240 V AC/DC	0-400 V AC / 0-600 V DC	1000 μ F	(activated / de-activated by DIP-switch)	CM-IWN.5	1SVR650660R0400	0.231 (0.509)
Passive device, no control supply voltage needed	0-690 V AC / 0-1000 V DC			CM-IVN	1SVR650669R9400	0.169 (0.373)

Ordering details - New range available at 4th quarter of 2012

Rated control supply voltage = measuring voltage	Nominal voltage U_n of the distribution system to be monitored	System leakage capacitance, max.	Adjustment range of the specified response value R_{an} (threshold)	Reference code	Catalog number	Weight (1 pce) kg (lb)
24-240 V AC/DC	0-250 V AC / 0-300 V DC	10 μ F	1-100 k Ω	CM-IWS.1S	1SVR730660R0100	0.148 (0.326)
				CM-IWS.1P	1SVR740660R0100	0.137 (0.302)
24-240 V AC/DC	0-400 V AC	10 μ F	1-100 k Ω	CM-IWS.2S	1SVR730670R0200	0.141 (0.311)
				CM-IWS.2P	1SVR740670R0200	0.130 (0.287)
24-240 V AC/DC	0-400 V AC / 0-600 V DC	20 μ F	1-100 k Ω 2-200 k Ω	CM-IWN.1S	1SVR750660R0200	0.241 (0.531)
				CM-IWN.1P	1SVR760660R0200	.217 (0.478)
24-240 V AC/DC	0-400 V AC / 0-600 V DC	500 μ	(activated / de-activated by DIPswitch)	CM-IWN.4S	1SVR750660R0300	0.241 (0.531)
				CM-IWN.4P	1SVR760660R0300	0.217 (0.478)
24-240 V AC/DC	0-400 V AC / 0-600 V DC	1000 μ F		CM-IWN.5S	1SVR750660R0400	0.241 (0.531)
				CM-IWN.5P	1SVR760660R0400	0.217 (0.478)
24-240 V AC/DC	0-400 V AC / 0-600 V DC	2000 μ F		CM-IWN.6S	1SVR760660R0500	0.241 (0.531)
				CM-IWN.6P	1SVR760660R0500	0.217 (0.478)

Insulation monitoring relays for unearthed supply systems

Operating state indication

LEDs, status information and fault messages CM-IWS.2

Operational state	LED U (green)	LED F (red)	LED R (yellow)
Start-up		OFF	OFF
No fault		OFF	
Insulation fault (below threshold value)			OFF
Invalid measuring result			OFF
Internal system fault	OFF		OFF
Test function		OFF	OFF
No fault after fault storage ¹⁾		²⁾	

1) The device has triggered after an insulation fault. The fault has been stored and the insulation resistance has returned to a higher value than the threshold value plus hysteresis.

2) Depending on the fault.

6

LEDs, status information and fault messages CM-IWS.1

Operational state	LED U (green)	LED F (red)	LED R (yellow)
Start-up		OFF	OFF
No fault		OFF	
Insulation fault (below threshold value)			OFF
KE/⊥ wire interruption			OFF
System leakage capacitance too high / invalid measurement result			OFF
Internal system fault	OFF		OFF
Test function		OFF	OFF
No fault after fault storage ¹⁾		²⁾	

1) The device has triggered after an insulation fault. The fault has been stored and the insulation resistance has returned to a higher value than the threshold value plus hysteresis.

2) Depending on the fault.

LEDs, status information and fault messages CM-IWN.1, CM-IWN.5

Operational state	LED U (green)	LED F (red)	LED R (yellow)
Start-up		OFF	OFF
No fault		OFF	¹⁾
Prewarning			
Insulation fault (below threshold value)			¹⁾
KE/⊥ wire interruption			¹⁾
L+/L- wire interruption during system start-up / test function	/		¹⁾
System leakage capacitance too high / invalid measurement result			¹⁾
Internal system fault	¹⁾		¹⁾
Setting fault ²⁾			
Test function		OFF	¹⁾
No fault after fault storage ³⁾		⁴⁾	

1) Depending on the configuration

2) Possible faulty setting: The threshold value for final switch-off is set at a higher value than the threshold value for prewarning.

3) The device has triggered after an insulation fault. The fault has been stored and the insulation resistance has returned to a higher value than the threshold value plus hysteresis.

4) Depending on the fault

Insulation monitoring relays for unearthed supply systems

Connection diagrams, DIP switches

Connection diagram CM-IWS.2

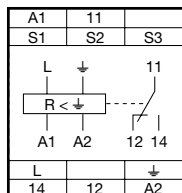

A1-A2 Control supply voltage
S1-S3 Remote test
S2-S3 Remote reset
L Measuring circuit/input, system connection
↓ Measuring circuit/input, earth connections
11-12/14 Output relay, closed-circuit principle

Connection diagram CM-IWS.1

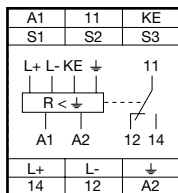

A1-A2 Control supply voltage
S1-S3 Remote test
S2-S3 Remote reset
L+, L- Measuring circuit/input, system connection
↓, KE Measuring circuit/input, earth connections
11-12/14 Output relay, closed-circuit principle

Connection diagram CM-IWN.1

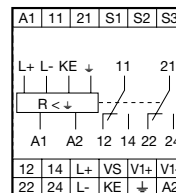

A1-A2 Control supply voltage
S1-S3 Remote test
S2-S3 Remote reset
L+, L-, ↓, KE Measuring circuit/input, system connection
VS, V1+, V1- Measuring circuit/input, earth connections
11-12/14 Connections for the coupling unit (if used)
21-22/24 Output relay 1, open- or closed-circuit principle
Output relay 2, open- or closed-circuit principle

DIP switches of IWN.1

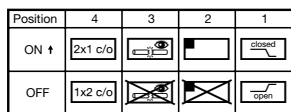

	ON	OFF (default)
DIP switch 1	Closed-circuit principle <input type="checkbox"/>	Open-circuit principle <input type="checkbox"/>
Operating principle of the output relays	If closed-circuit principle is selected, the output relays de-energize in case a fault is occurring. In non-fault state the relays are energized.	If open-circuit principle is selected, the output relays energize in case a fault is occurring. In non-fault state the relays are de-energized.
DIP switch 2	Fault storage activated (latching) <input type="checkbox"/>	Fault storage de-activated (non latching) <input checked="" type="checkbox"/>
Non-volatile fault storage	If the fault storage function is activated, the output relays remain in tripped position until a reset is done either by the front-face button or by the remote reset connection S2-S3. This function is non-volatile.	If the fault storage function is de-activated, the output relays switch back to their original position as soon as the insulation fault no longer exists.
DIP switch 3	Interrupted wire detection activated <input checked="" type="checkbox"/>	Interrupted wire detection de-activated <input type="checkbox"/> With this configuration the interrupted wire detection is de-activated.
Interrupted wire detection	With this configuration, the CM-IWN.1 monitoring relays the wires connected to + and KE for interruptions.	
DIP switch 4	2 x 1 c/o (SPDT) contact <input checked="" type="checkbox"/>	1 x 2 c/o (SPDT) contacts <input type="checkbox"/>
2 x 1 c/o, 1 x 2 c/o	If operating principle 2 x 1 c/o contact is selected, the output relay R1 (11-12/14) reacts to threshold value R1 (final switch-off) and the output relay R2 (21-22/24) reacts to threshold value R2 (prewarning)	If operating principle 1 x 2 c/o contacts is selected, both output relays R1 (11-12/14) and R2 (21-22/24) react synchronously to threshold value R1. Settings of the threshold value R2 have no effect on the operation.

Connection diagram CM-IVN

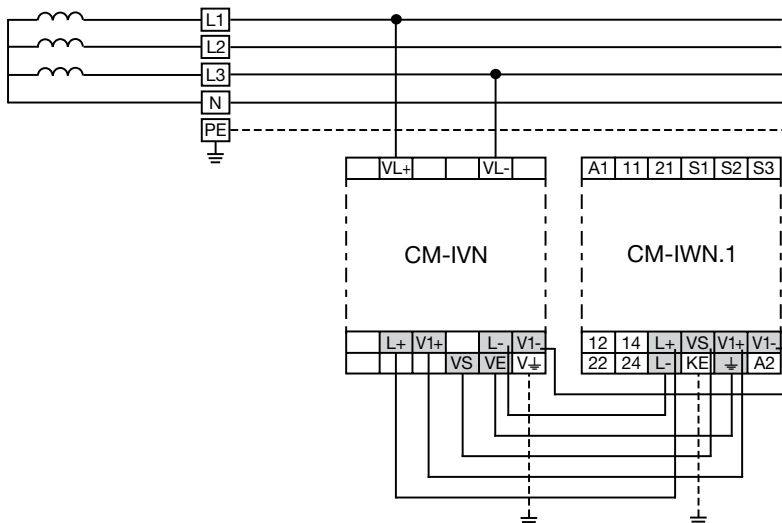

VE Connection to CM-IWN.1 - ↓
VS Connection to CM-IWN.1 - VS
L+ Connection to CM-IWN.1 - L+
V1+ Connection to CM-IWN.1 - V1+
L- Connection to CM-IWN.1 - L-

V1- Connection to CM-IWN.1 - V1-
VL+, VL- Measuring circuit / Measuring input
Connection to the system
V↓ Measuring circuit / Measuring input
Connection to earth

Insulation monitoring relays for unearthed supply systems

Technical data

Data at $T_a = 25\text{ °C}$ and rated values, unless otherwise indicated

		CM-IWS.2	CM-IWS.1	CM-IWN.1,4,5,6
Input circuit - Supply circuit				
Rated control supply voltage U_c		A1 - A2 24-240 V AC/DC		
Rated control supply voltage tolerance		-15...+10 %		
Typical current / power consumption	24 V DC	30 mA / 0.7 VA	35 mA / 0.9 VA	55 mA / 1.3 VA
	115 V AC	12 mA / 1.4 VA	17 mA / 2.0 VA	20 mA / 2.3 VA
	230 V AC	12 mA / 2.8 VA	14 mA / 3.2 VA	15 mA / 3.5 VA
Rated frequency f_n		DC or 15-400 Hz		
Frequency range AC		13.5-440 Hz		
Power failure buffering time	min.	20 ms		
Input circuit - Measuring circuit				
Monitoring function		L, ↓	L+, L-, ↓, KE	L+, L-, ↓, KE
Measuring principle		insulation resistance monitoring of IT systems (IEC/EN 61557-8) superimposed DC voltage	prognostic measuring principle with superimposed square wave signal	
Nominal voltage U_n of the distribution system to be monitored		0-400 V AC	0-250 V AC / 0-300 V DC	400 V AC / 0-600 V DC
Voltage range of the distribution system to be monitored		0-460 V AC (tolerance +15 %)	0-287.5 V AC / 0-345 V DC (tolerance +15 %)	0-460 V AC / 0-690 V DC (tolerance +15 %)
Rated frequency f_n of the distribution system to be monitored		50-60 Hz	DC or 15-400 Hz	DC or 15-400 Hz
System leakage capacitance C_e	max.		10 μ F	CM-IWN.1 20 μ F CM-IWN.5 1000 μ F
Tolerance of the rated frequency f_n		45-65 Hz	13.5-440 Hz	13.5-440 Hz
Extraneous DC voltage U_{dc} (when connected to an AC system)	max.	none	290 V DC	460 V DC
Number of possible response / threshold values			1	2
Adjustment range of the specified response value R_{an} (threshold)	min.-max.		1-100 k Ω	-
	min.-max. R1		-	1-100 k Ω
	min.-max. R2		-	2-200 k Ω (activated / de-activated by DIP-switch)
Adjustment resolution			1 k Ω	
	R1		1 k Ω	1 k Ω
	R2		-	2 k Ω
Tolerance of the adjusted threshold value / Relative percentage uncertainty A	at 1-10 kW R_F		± 0.5 k Ω	-
at -5...+45 °C, $U_n = 0-115$ %, $U_s = 85-110$ %, $f_n = 15$ Hz, $C_e = 1$ μ F	at 10-100 kW R_F		± 6 %	-
	at 1-15 kW R_F		-	± 1 k Ω *
	at 15-200 kW R_F		-	± 8 %
Hysteresis related to the threshold value			25 %; min. 2 k Ω	
Internal impedance Z	at 50 Hz	135 k Ω	100 k Ω	155 k Ω
Internal DC resistance R		185 k Ω	115 k Ω	185 k Ω
Measuring voltage U_m		15 V	22 V	24 V
Tolerance of measuring voltage U_m			+10 %	
Measuring current I_m	max.	0.1 mA	0.3 mA	0.15 mA
Response time t_{an}	pure AC system	0.5 x R_{an} and $C_e = 1$ μ F		
	DC system or AC system with connected rectifiers			max. 15 s
Repeat accuracy (constant parameters)				< 0.1 % of full scale
Accuracy of R_a (measured value) within the rated control supply voltage tolerance				< 0.05 % of full scale
Accuracy of R_a (measured value) within the operation temperature range	at 1-10 kW R_F		5 W / K	-
	at 10-100 kW R_F		0.05 % / K	-
	at 10-200 kW R_F		-	0.05 % / K
Transient over voltage protection ($\frac{1}{2}$ - terminal)		Z-diode		avalanche diode
Input circuit - Control circuits				
Control inputs - volt free	S1-S3		S1 - S2 - S3	
	S2-S3		remote test	
			remote reset	
Maximum switching current in the control circuit			1 mA	
Maximum cable length to the control inputs			50 m - 100 pF/m [164 ft - 30.5 pF/ft]	
Minimum control pulse length			150 ms	
No-load voltage at the control input		≤ 24 V ± 5 %		≤ 24 V DC
Indication of operational states				
Control supply voltage			LED U (green)*	
Fault message			LED F (red)*	
Relay status			LED R (yellow)*	

*in combination with CM-IVN ± 1.5 k Ω

Insulation monitoring relays for unearthed supply systems

Technical data

Measuring &
monitoring relays
CM Range

	CM-IWS.2	CM-IWS.1	CM-IWN.1,4,5,6
Output circuits			
Kind of output	relay, 1 c/o (SPDT) contact		2 x 1 or 1 x 2 c/o (SPDT) contacts configurable
Operating principle	closed-circuit principle ¹⁾		open- or closed circuit principle ¹⁾ configurable
Contact material	AgNi alloy, Cd free		
Rated voltage (VDE 0110, IEC 60947-1)	250 V AC / 300 V DC		
Min. switching voltage / Min. switching current	24 V / 10 mA		
Max. switching voltage / Max. switching current	see data sheet		
Rated operational current I _o (IEC/EN 60947-5-1)	AC12 (resistive) at 230 V	4 A	
	AC15 (inductive) at 230 V	3 A	
	DC12 (resistive) at 24 V	4 A	
	DC13 (inductive) at 24 V	2 A	
AC rating (UL 508)	Utilization category (Control Circuit Rating Code)	B 300, pilot duty general purpose (250 V, 4 A, cos φ 0.75)	
	max. rated operational voltage	250 V AC	
	max. continuous thermal current at B 300	4 A	
	max. making/breaking apparent power at B 300	3600/360 VA	
Mechanical lifetime		30 x 10 ⁶ switching cycles	
Electrical lifetime (AC12, 230 V, 4 A)		0.1 x 10 ⁶ switching cycles	
Max. fuse rating to achieve short-circuit protection	n/c contact	6 A fast-acting	
	n/o contact	10 A fast-acting	
Conventional thermal current I _{th} (IEC/EN 60947-1)		4 A	
General data			
Duty time		100 %	
Dimensions (W x H x D)		22.5 x 78 x 100 mm [0.89 x 3.07 x 3.94 in]	45 x 78 x 100 mm [1.78 x 3.07 x 3.94 in]
Weight	gross weight	0.149 kg [0.328 lb]	0.163 kg [0.359 lb]
	net weight	0.127 kg [0.280 lb]	0.133 kg [0.293 lb]
Mounting		DIN rail (EN 60715), snap-on mounting without any tool	
Mounting position		any	
Minimum distance to other units	vertical	not necessary	
	horizontal	10 mm [0.4 in] at U _n > 240 V	10 mm [0.4 in] at U _n > 400 V
Degree of protection	housing / terminal	IP50 / IP20	
Electrical connection			
Wire size	fine-strand with(out) wire end ferrule	2 x 0.75-2.5 mm ² (2 x 18-14 AWG)	
	rigid	2 x 0.5-4 mm ² (2 x 20-12 AWG)	
Stripping length		7 mm [0.28 in]	
Tightening torque		0.6-0.8 Nm [5.31-7.08 lb.in]	
Environmental data			
Ambient temperature ranges	operation/storage/ transport	-25...+60 °C/-40...+85 °C/-40...+85 °C	
Climatic category	IEC/EN 60721-3-3	3K5 (no condensation, no ice formation)	
Damp heat, cyclic	IEC/EN 60068-2-30	6 x 24 h cycle, 55 °C, 95 % RH	
Vibration, sinusoidal	IEC/EN 60255-21-1	Class 2	
Shock, half-sine	IEC/EN 60255-21-2	Class 2	

6

Insulation monitoring relays for unearthed supply systems

Technical data

6

		CM-IWS.2	CM-IWS.1	CM-IWN.1,4,5,6
Isolation data				
Rated impulse withstand voltage U_{imp} between all isolated circuits (IEC/EN 60947-1, IEC/EN 60664-1, VDE 0110-1)	supply / measuring circuit		6 kV	
	supply / output circuit		6 kV	
	measuring / output circuit		6 kV	
	output 1 / output circuit 2			4 kV
Pollution degree (IEC/EN 60664-1, VDE 0110-1)			3	
Overvoltage category (IEC/EN 60664-1, VDE 0110-1)			III	
Rated insulation voltage U (IEC/EN 60947-1, IEC/EN 60664-1, VDE 0110-1)	supply / measuring circuit	400 V	300 V	600 V
	supply / output circuit		300 V	
	supply / measuring circuit	400 V	300 V	600 V
	output 1 / output circuit 2	-	-	300 V
Basis isolation for rated control supply voltage (IEC/EN 60664-1, VDE 0110-1)	supply / measuring circuit	400 V AC / 300 V DC	250 V AC / 300 V DC	400 V AC / 600 V DC
	supply / output circuit		250 V AC / 300 V DC	
	measuring / output circuit	400 V AC / 300 V DC	250 V AC / 300 V DC	400 V AC / 600 V DC
	output 1 / output 2		250 V AC / 300 V DC	
Protective separation (IEC/EN 61140)	supply / output circuit		250 V AC / 250 V DC	
	supply / measuring circuit		250 V AC / 250 V DC	
	measuring / output circuit		250 V AC / 250 V DC	
	supply / output circuit		2.32 kV, 50 Hz, 2 s	
Test voltage between all isolated circuits, routine test (IEC/EN 60255-5, IEC/EN 61010-1)	supply / measuring circuit		2.32 kV, 50 Hz, 2 s	
	measuring / output circuit	2.2 kV, 50 Hz, 1 s		2.53 kV, 50 Hz, 1 s
Standards				
Product standard		IEC/EN 61557-8, IEC/EN 60255-6		
Other standards		EN 50178		
Low Voltage Directive		2006/95/EC		
EMC Directive		2004/108/EC		
RoHS Directive		2002/95/EC		
Electromagnetic compatibility				
Interference immunity to		IEC/EN 61000-6-1, IEC/EN 61000-6-2, IEC/EN 61326-2-4		
electrostatic discharge	IEC/EN 61000-4-2	Level 3, 6 kV / 8 kV		
radiated, radio-frequency, electromagnetic field	IEC/EN 61000-4-3	Level 3, 10 V/m (1 GHz) / 3 V/m (2 GHz) / 1 V/m (2.7 GHz)		
electrical fast transient/burst	IEC/EN 61000-4-4	Level 3, 2 kV / 5 kHz		
surge	IEC/EN 61000-4-5	Level 3, installation class 3, supply circuit and measuring circuit 1 kV L-L, 2 kV L-earth		
conducted disturbances, induced by radio-frequency fields	IEC/EN 61000-4-6	Level 3, 10 V		
voltage dips, short interruptions and voltage variations	IEC/EN 61000-4-11	Level 3		
harmonics and interharmonics	IEC/EN 61000-4-13	Level 3		
high-frequency radiated	IEC/CISPR 22, EN 50022	IEC/EN 61000-6-3, IEC/EN 61000-6-4 Class B		
high-frequency conducted	IEC/CISPR 22, EN 50022	Class B		

Insulation monitoring relays for unearthed supply systems

Technical data

Measuring & monitoring relays
CM Range

6

Technical data - CM-IVN

Input circuit - Measuring circuit		VL+, VL-, V±
Function		expansion of the nominal voltage range of the insulation monitoring relay CM-IWN.1 to 690 V AC or 1000 V DC, max. length of connection cable 40 cm
Measuring principle		see CM-IWN.1
Nominal voltage U_n of the distribution system to be monitored		0-690 V AC / 0-1000 V DC
Voltage range of the distribution system to be monitored		0-793.5 V AC / 0-1150 V DC (tolerance +15 %)
Rated frequency f_N of the distribution system to be monitored		DC or 15-400 Hz
Tolerance of the rated frequency f_N		13.5-440 Hz
System leakage capacitance C_e	max.	20 μ F
Extraneous DC voltage U_d (when connected to an AC system)	max.	793.5 V DC
Tolerance of the adjusted threshold value / Relative percentage uncertainty A at -5...+45 °C, $U_n = 0-115$ %	at 1-15 k Ω R_F	± 1.5 k Ω
$U_n = 85-110$ %	at 15-200 k Ω R_F	± 8 %
$f_N, f_c, C_e = 1 \mu$ F	at 50 Hz	195 k Ω
Internal impedance Z		200 k Ω
Internal DC resistance R_i		24 V
Measuring voltage U_m		+10 %
Tolerance of measuring voltage U_m		0.15 mA
Measuring current I_m		
General data		
MTBF		on request
Duty time		100 %
Dimensions (W x H x D)		45 x 78 x 100 mm [1.78 x 3.07 x 3.94 in]
Weight	gross weight	0.200 kg [0.441 lb]
	net weight	0.169 kg [0.373 lb]
Mounting		DIN rail (IEC/EN 60715), snap-on mounting without any tool
Mounting position		any
Minimum distance to other units	vertical	not necessary
	horizontal	10 mm [0.4 in] at $U_n > 600$ V
Degree of protection		IP50 / IP20
Electrical connection		
Wire size	fine-strand with(out) wire end ferrule	2 x 0.75-2.5 mm ² (2 x 18-14 AWG)
	rigid	2 x 0.5-4 mm ² (2 x 20-12 AWG)
Stripping length		7 mm [0.28 in]
Tightening torque		0.6-0.8 Nm [5.31-7.08 lb.in]
Max. length of connection cable to CM-IWN.1		40 cm
Environmental data		
Ambient temperature ranges	operation / storage / transport	-25...+60 °C / -40...+85 °C / -40...+85 °C
Climatic category	IEC/EN 60721-3-3	3K5 (no condensation, no ice formation)
Damp heat, cyclic	IEC/EN 60068-2-30	6 x 24 h cycle, 55 °C, 95 % RH
Vibration, sinusoidal	IEC/EN 60255-21-1	Class 2
Shock, half-sine	IEC/EN 60255-21-2	Class 2
Isolation data		
Rated impulse withstand voltage U_{imp} between all isolated circuits (IEC/EN 60947-1, IEC/EN 60664-1, VDE 0110-1)	input circuit / PE	8 kV
Pollution degree (IEC/EN 60664-1, VDE 0110-1)		3
Overvoltage category (IEC/EN 60664-1, VDE 0110-1)		III
Rated insulation voltage U_i (IEC/EN 60947-1, IEC/EN 60664-1, VDE 0110-1)	input circuit / PE	1000 V
Test voltage between all isolated circuits, routine test (IEC/EN 60255-5, IEC/EN 61010-1)	input circuit / PE	3.3 kV, 50 Hz, 1 s
Standards		
Product standard		IEC/EN 61557-8, IEC/EN 60255-6
Other standards		EN 50178
Low Voltage Directive		2006/95/EC
EMC Directive		2004/108/EC
RoHS Directive		2002/95/EC
Electromagnetic compatibility		
Interference immunity to electrostatic discharge	IEC/EN 61000-4-2	IEC/EN 61000-6-1, IEC/EN 61000-6-2, IEC/EN 61326-2-4 Level 3, 6 kV / 8 kV
radiated, radio-frequency, electromagnetic field	IEC/EN 61000-4-3	Level 3, 10 V/m (1 GHz) / 3 V/m (2 GHz) / 1 V/m (2.7 GHz)
electrical fast transient/burst surge	IEC/EN 61000-4-4 IEC/EN 61000-4-5	Level 3, 2 kV / 5 kHz Level 3, installation class 3, supply circuit and measuring circuit 1 kV L-L, 2 kV L-earth
conducted disturbances, induced by radio-frequency fields	IEC/EN 61000-4-6	Level 3, 10 V
voltage dips, short interruptions and voltage variations	IEC/EN 61000-4-11	Level 3
harmonics and interharmonics	IEC/EN 61000-4-13	Level 3
Interference emission		IEC/EN 61000-6-3, IEC/EN 61000-6-4
high-frequency radiated	IEC/CISPR 22, EN 50022	Class B
high-frequency conducted	IEC/CISPR 22, EN 50022	Class B

Insulation monitoring relays for unearthed supply systems

Application examples

Application example CM-IWS.2

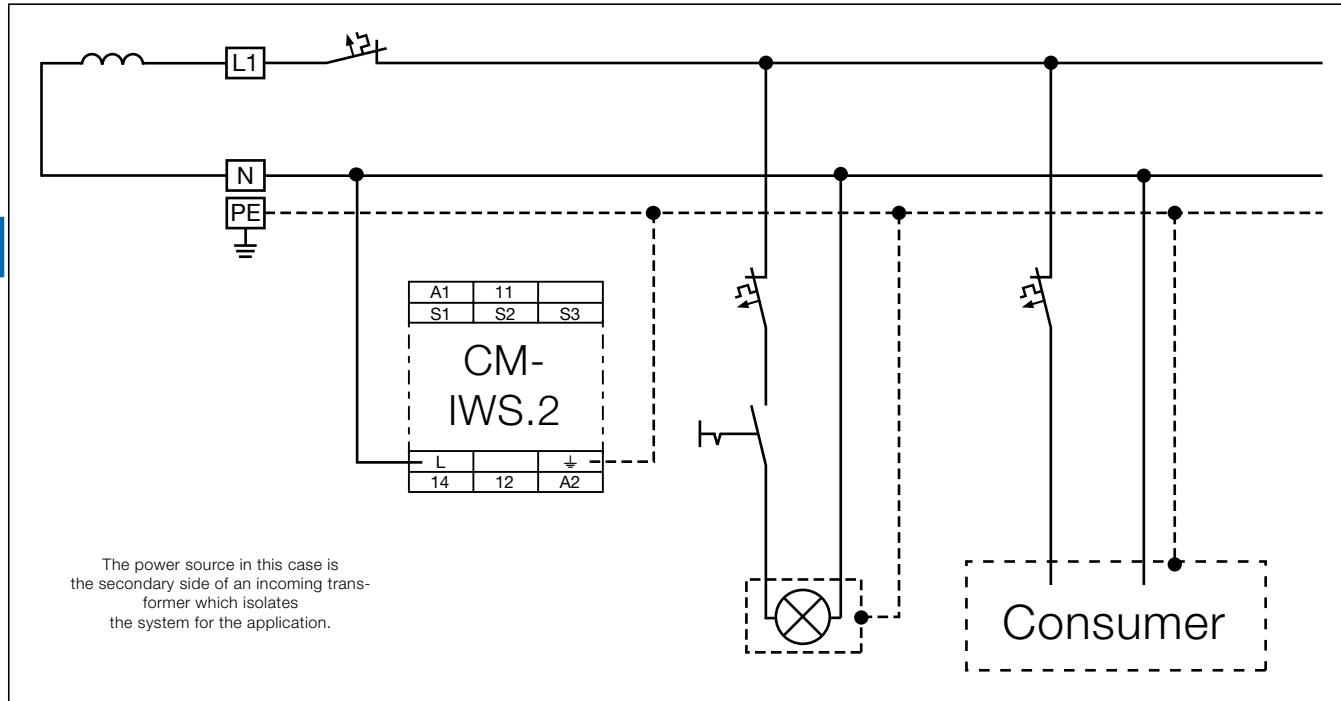

Application example CM-IWS.1

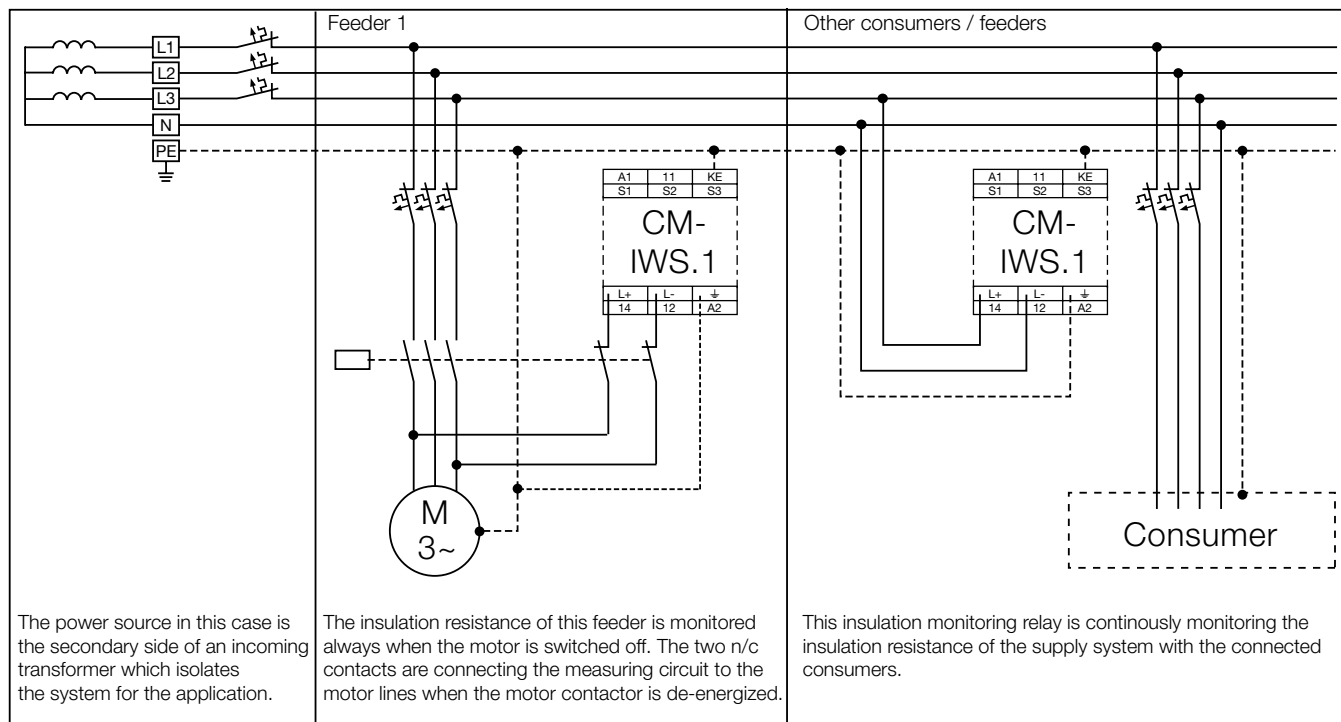

Earth fault / insulation resistance monitoring of different feeder circuits with fault localization.

CM-E Range Motor load monitoring relays



Motor load monitoring relays



Motor load monitoring relays

Fields of application

The motor load monitor relay monitors the load states of single-phase and three-phase asynchronous motors. The evaluation of the phase angle between current and voltage allows a very precise monitoring of the load states.

Compared with other conventional measuring principles (e.g. pressure transducers, current measurement), $\cos \varphi$ monitoring is a more precise and economical alternative. The motor is used as a sensor for its own load status.

Main applications

- Pump monitoring
 - Dry-running protection (underload)
 - Closed valves (overload)
 - Pipe break (overload)
- Heating, air-conditioning, ventilation
 - Monitoring of filter pollution
 - V-belt breakage (underload)
 - Closed shutters/valves (overload)
 - Air ventilating volume
- Agitating machines
 - High consistency within the tank (overload)
 - Pollution of the tank (overload)
- Transport/Conveyance
 - Congested conveyor belts (overload)
 - Jamming of belts (overload)
 - Material accumulation in spiral conveyors (overload)
 - Lifting platforms
- Machine installation
 - Wear of tools, e.g. worn saw blades in circular saws, etc. (overload)
 - Tool breakage (underload)
 - V-belt drives (breakage underload)

Pump control

Dry-running protection

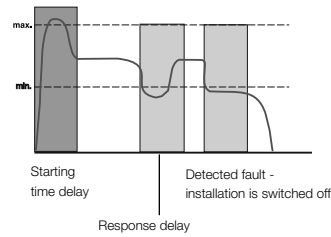

Filter pollution

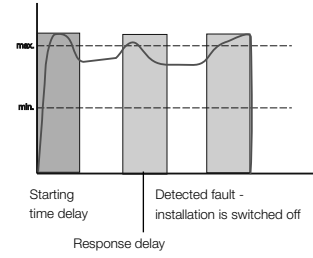

Ventilator monitoring

V-belt monitoring

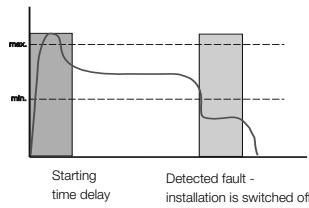

Filter pollution

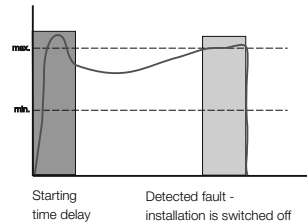

Wiring examples (for motor currents ≤ 20 A)

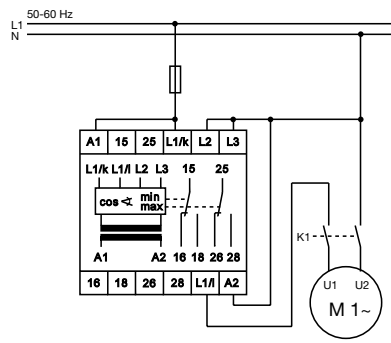
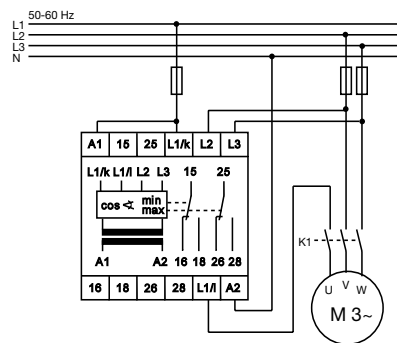

Wiring examples (for motor currents ≥ 20 A)

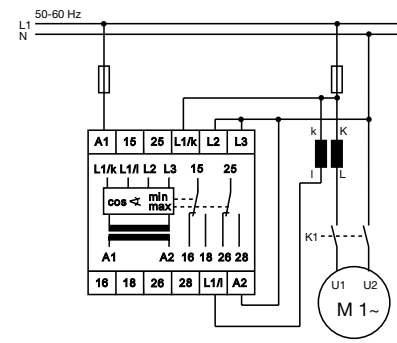
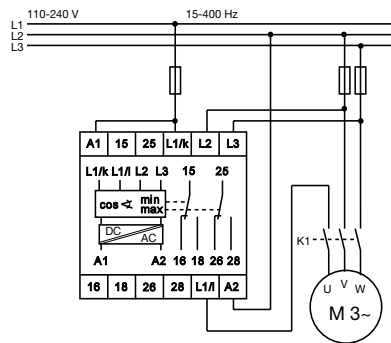
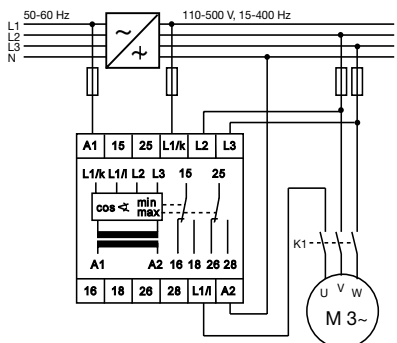
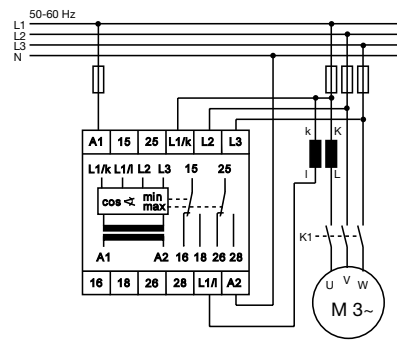

Motor load monitoring relays

Ordering details



CM-LWN

Description

The motor load monitor CM-LWN monitors the load of single-phase and three-phase asynchronous motors. The evaluation of the phase angle between current and voltage ($\cos \varphi$ monitoring) allows a very precise monitoring of the load status.

Ordering details

Rated control supply voltage = measuring voltage	Current range	Reference code	Catalog number	Weight (1 pce) kg (lb)
24-240 V AC/DC	0.5-5 A	CM-LWN	1SVR450335R0000	0.30 (0.66)
110-130 V AC			1SVR450330R0000	0.30 (0.66)
220-240 V AC			1SVR450331R0000	0.30 (0.66)
380- 440 V AC			1SVR450332R0000	0.30 (0.66)
480-500 V AC			1SVR450334R0000	0.30 (0.66)
24-240 V AC/DC	2-20 A		1SVR450335R0100	0.30 (0.66)
110-130 V AC			1SVR450330R0100	0.30 (0.66)
220-240 V AC			1SVR450331R0100	0.30 (0.66)
380- 440 V AC			1SVR450332R0100	0.30 (0.66)
480-500 V AC			1SVR450334R0100	0.30 (0.66)

Characteristics

- Pump monitoring
- Under and overload monitoring $\cos \varphi$ and $\cos \varphi$ in one unit
- Adjustable starting delay 0.3-30 s
- Direct measurement of currents up to 20 A
- Adjustable response time delay 0.2-2 s
- Single-phase or three-phase monitoring
- 2 x 1 c/o contact, closed-circuit principle
- 3 LEDs for status indication
- Under- and overload monitoring

Motor load monitoring relays

Technical information

The **CM-LWN** module monitors the load status of inductive loads.

The primary application is the monitoring of single- or three-phase asynchronous motors (squirrel cage) under varying load conditions. The measuring principle is based on the evaluation of the phase shift (φ) between the voltage and the current in one phase.

The phase difference is nearly inversely proportional to the load. Therefore, $\cos \varphi$, measured relatively from 0 to 1, measures the relationship of effective power to apparent power. A value towards 0 indicates low load and a value towards 1 indicates high load.

Threshold values can be set individually for $\cos \varphi_{\max}$ and $\cos \varphi_{\min}$. If the set threshold value is reached, a LED lights up and the relay is de-energized.

If $\cos \varphi$ returns to the acceptable limits (taking into account the hysteresis), the relay is reset to its original state and the LED flashes permanently to indicate the occurrence of the trip event. This message can be deleted using the reset button or by switching off the supply.

A time delay (Time S) of 0.3 to 30 s can be set for the starting phase of the motor. It is also possible to set a response delay time (Time R) of 0.2 to 2 s to suppress unwanted tripping due to unavoidable short load changes during normal operation.

6 To guarantee correct operation of the response delay (Time R), the adjusted value for $\cos \varphi_{\max}$ has to be higher than the value for $\cos \varphi_{\min}$ plus the hysteresis. Consequently, the overload and underload indication must not be active at the same time.

Due to the internal electrical isolation of the supply circuit and the measuring circuit, it is also possible to use the device in systems with different supply voltages.

Function diagram CM-LWN

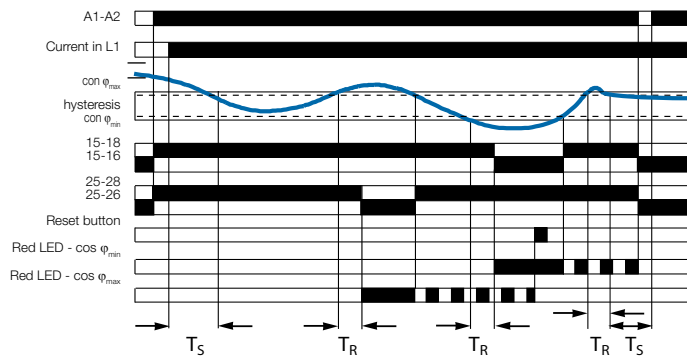

Connection diagram CM-LWN

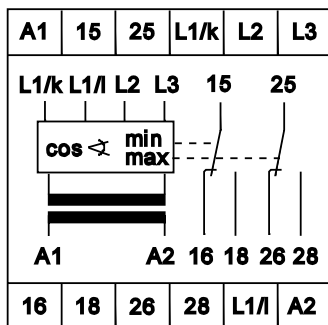

- A1-A2 Rated control supply voltage
- L1/K-L1/L Measuring current
- L1/K-L2-L3 Measuring voltage
- 15-16/18 Output contacts - underload ($\cos \varphi_{\min}$)
- 25-26/28 Output contacts - overload ($\cos \varphi_{\max}$) closed-circuit principle

Motor load monitoring relays

Technical data

Type		CM-LWN
Input circuit - Supply circuit		A1-A2
Rated control supply voltage U_s - power consumption	A1-A2	24-240 V AC/DC approx. 8.4 VA/W
	A1-A2	110-130 V AC approx. 3.6 VA
	A1-A2	220-240 V AC approx. 3.6 VA
	A1-A2	380-440 V AC approx. 3.6 VA
	A1-A2	480-500 V AC approx. 3.6 VA
Rated control supply voltage U_s tolerance		-15 %...+10 %
Rated frequency	AC versions	50-60 Hz
	AC/DC versions	15-400 Hz or DC
Duty time		100 %
Measuring circuit		L1/L-L1/K-L2-L3
Monitoring function		Motor load monitoring by $\cos \varphi$
Voltage range	L1/K-L2-L3	110-500 V AC single-phase or three-phase
Current range	L1/L-L1/K	0.5-5 A version 2-20 A version
Permissible overload of current input		25 A for 3 s 100 A for 3 s
Thresholds		$\cos \varphi_{\min}$ and $\cos \varphi_{\max}$ adjustable from 0 to 1
Hysteresis (related to phase angle φ in °)		4°
Frequency of measuring voltage		15-400 Hz
Response time		300 ms
Timing circuits		indication of over- and undervoltage fault
Start-up time (Time S)		0.3-30 s, adjustable
Response delay (Time R)		0.2-2 s, adjustable
Accuracy within the rated control supply voltage tolerance		$\Delta t \leq 0.5 \%$
Accuracy within the temperature range		$\Delta t \leq 0.06 \%$ / °C
Indication of operational states		
Control supply voltage		U: green LED
below $\cos \varphi_{\min}$		$\cos \varphi_{\min}$: red LED
$\cos \varphi_{\max}$ exceeded		$\cos \varphi_{\max}$: red LED
Output circuits		15-16/18, 25-26/28
Kind of output		2 x 1 c/o contact
Operational principle ¹⁾		closed-circuit principle
Contact material		AgCdO
Rated voltage (VDE 0110, IEC 664-1, IEC 947-1)		250 V
Max. switching voltage		400 V AC, 300 V DC
Rated operational current I_b (IEC/EN 60947-1)	AC12 (resistive) 230 V	4 A
	AC15 (inductive) 230 V	3 A
	DC12 (resistive) 24 V	4 A
	DC13 (inductive) 24 V	2 A
AC rating (UL 508)	Utilization category (Control Circuit Rating Code)	B 300
	max. rated operational voltage	300 V AC
	max. continuous thermal current at B 300	5 A
	max. making/breaking apparent power at B 300	3600/360 VA
Mechanical lifetime		30×10^6 switching cycles
Electrical lifetime	at AC12, 230 V, 4 A	0.1×10^6 switching cycles
Max. fuse rating to achieve short-circuit protection	n/c / n/o contact	10 A fast-acting / 10 A fast-acting
General data		
Dimensions (W x H x D)		45 mm x 78 mm x 100 mm (1.77 inch x 3.07 inch x 3.94 inch)
Mounting position		any
Degree of protection	housing / terminals	IP50 / IP20
Ambient temperature range	operation / storage	-25...+65 °C / -40...+85 °C
Mounting		DIN rail (IEC/EN 60715)
Electrical connection		
Wire size	fine-strand with wire end ferrule	2 x 2.5 mm ² (2 x 14 AWG)
Standards		
Product standard		IEC 255-6, EN 60255-6
Low Voltage Directive		2006/95/EC
EMC Directive		2004/108/EC, 91/263/EEC, 92/31/EEC, 93/68/EEC, 93/67/EEC
Electromagnetic compatibility		EN 61000-6-2, EN 61000-6-4
electrostatic discharge	IEC/EN 61000-4-2	Level 3 (6 kV / 8 kV)
radiated, radio-frequency, electromagnetic field	IEC/EN 61000-4-3	Level 3 (10 V/m)
electrical fast transient / burst	IEC/EN 61000-4-4	Level 3 (2 kV / 5 kHz)
surge	IEC/EN 61000-4-5	Level 4 (2 kV L-L)
conducted disturbances, induced by radio-frequency fields	IEC/EN 61000-4-6	Level 3 (10 V)
Operational reliability (IEC 68-2-6)		5 g
Mechanical resistance (IEC 68-2-6)		10 g
Environmental testing (IEC 68-2-30)		24 h cycle time, 55 °C, 93 % rel., 96 h
Isolation data		
Rating (HD 625.1 S1, VDE 0110, IEC 664-1, IEC 60255-5)		250 V, 400 V, 500 V depending on the version
Rated insulation voltage between supply-, measuring- and output circuit		4 kV / 1.2 - 50 us
Rated impulse withstand voltage between all isolated circuits		2.5 kV, 50 Hz, 1 min.
Test voltage between all isolated circuits		3
Pollution category		III
Overvoltage category		III

¹⁾ Open-circuit principle: Output relay is energized if the measured value exceeds/drops below the adjusted threshold.

Closed-circuit principle: Output relay is de-energized if the measured value exceeds/drops below the adjusted threshold.

Notes



CM-E Range Motor control and protection

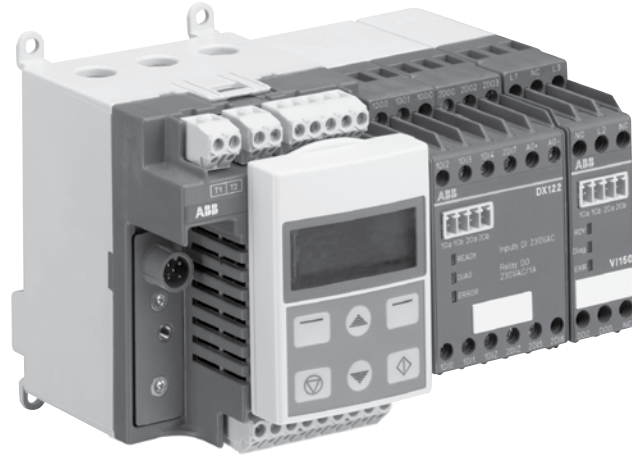

Motor control and protection

Benefits and advantages

UMC100-FBP is a flexible, modular and expandable motor management system for constant-speed low-voltage range motors.

Its most important tasks include motor protection, prevention of plant standstills and the reduction of down time. This is made possible by early information relating to possible motor problems which avoids unplanned plant standstills. Even if a motor trips, quick diagnosis of the cause of the fault serves to reduce downtime.

UMC100-FBP combines in a very compact unit:

Motor protection

- Overload, underload
- Overvoltage, undervoltage
- Blocked rotor, low / high current
- Phase failure, imbalance, phase sequence
- Earth leakage
- Thermistor protection
- Limitation of starts per time
- One single version with integrated measuring system covers the rated motor current from 0,24 to 63 A

Motor control

- Integrated and easy to parametrize motor starter functions like direct, reverse, star-delta,...
- Additionally free programmable logic for application specific control functions
- Expansion modules DX111, DX122 for more I/Os
- Expansion modules VI150, VI155 for 3-phase voltage measuring

Motor diagnostics

- Quick and comprehensive access to all relevant data via fieldbus and/or operator panel
- Current, thermal load
- Phase voltages
- Power factor
- Energy

Communication

- Communication-independent basic device
- Freely selectable fieldbus protocol with FieldBusPlug
- Profibus DP
- DeviceNet
- Modbus
- CANopen

Typical application segments

- Oil & gas
- Cement
- Paper
- Mining
- Steel
- Chemical industry

Further information

UMC & FBP Catalogue 2CDC 190 022 D0204
UMC & FBP Brochure 2CDC 135 011 B0202

Motor control and protection

Technical data



Basic device UMC100-FBP

UMC100-FBP allows the connection of one I/O-expansion module DX111 or DX122, and one voltage module VI150 or VI155. Expansion modules are connected via 2-wire bus, the max. distance to UMC100-FBP is 3 m.

Main power

Voltage	max 1000 V AC
Frequency	45 to 65 Hz
Rated motor current	0.24 to 63 A, without accessories
	Greater currents with transformer
Transformer diameter	11 mm (max 25 mm2)
Tripping classes	5, 10, 20, 30, 40 in accordance with EN/IEC 60947-4-1
Short-circuit protection	Separate fuse on network side

6

Control unit

Supply voltage	24 V DC
Reverse polarity protection	yes
Inputs	6 digital inputs 24 V DC 1 PTC input
Outputs	3 relay outputs relay 1 digital output transistor
Interfaces	1 for ABB FieldBusPlug 1 for UMC100-PAN control station 1 for expansion module
Parametric assignment	via fieldbus, control station and / or software
Addressing	Control station or addressing set
LEDs	3 LEDs: green, yellow, red

Environment and mechanical data

Fastening	on DIN busbar (EN50022-35) or with 4 screws x M4
Dimensions (W x H x D)	70 x 105 x 110 mm (incl. FieldBusPlug and control panel)
Weight	0.39 kg
Terminal cross-section	max. 2.5 mm ² or 2 x 1.5 mm ²



I/O-expansion modules DX111 / DX122

Expansion modules to increase the number of I/Os of a UMC100-FBP. Easy use of inputs by parametrizing for fault or warning; individual message on operator panel configurable.

Supply voltage	24 V DC	
Inputs	DX111	8 digital inputs 24 V DC
	DX122	8 digital inputs 110/230 V AC
Outputs		4 relay outputs relay
		1 analogue output, 0/4 to 20 mA / 0 to 10 V configurable
Fastening	on DIN busbar (EN50022-35)	
Dimensions (W x H x D)	45 x 77 x 100 mm (without terminal block)	

Motor control and protection

Technical data

Voltage expansion modules

Measures the 3 phase voltages of a motor. Different versions for use in grounded and ungrounded networks.



Supply voltage		24 V DC
Inputs	VI150	3 analogue inputs 150 - 690 V AC
		For use in grounded networks
		Maximum operation altitude 2000 m
Inputs	VI155	3 analogue inputs 150 - 690 V AC
		For use in all networks
		Maximum operation altitude > 2000 m
Outputs		1 relay output
Fastening		on DIN busbar (EN50022-35)
Dimensions (W x H x D)		22.5 x 77 x 100 mm (without terminal block)

Control panel UMC100-PAN

Installation on the device or on the switching cabinet door

Graphics-enabled and backlit display, 3 LEDs for status indication

Freely configurable error messages

Multilingual: German, English, French, Italian, Portuguese, Spanish, Russian



For more detailed information about the UMC100, see section 2, pages 2.16 and 2.17

Universal motor controller – 0.24...63 A



UMC100-FBP

Type	Description	Catalog number
UMC100-FBP.0	Universal Motor Controller	1SAJ520000R0101
UMC100-FBP.2	Universal Motor Controller, ATEX	1SAJ520000R0201
UMC100-PAN	Operating, diagnostics and parameter setting panel; direct UMC mounting	1SAJ590000R0102
UMCPAN-CAB.070	0.7 m ext. cable with door mounting set	1SAJ510003R0001
UMCPAN-CAB.150	1.5 m ext. cable with door mounting set	1SAJ510004R0001
UMCPAN-CAB.30	3 m ext. cable with door mounting set	1SAJ510002R0001
DTM software	Advanced programming, parameter assignment	1SAJ924012R0004
VI150-FBP.0	Voltage Expansion Module, analog inputs 150...690V AC, 1 relay output, for 3-phase networks (grounded)	1SAJ650000R0100
VI155-FBP.0	Voltage Expansion Module, analog inputs 150...690V AC, 1 relay output, for 3-phase networks (all)	1SAJ655000R0100

CM-E Range

Thermistor motor protection



Thermistor motor protection



Thermistor motor protection relays

Benefits and advantages

Selection table

Operating principle and fields of application for thermistor motor protection relays

The CM range of thermistor motor protection relays are used to control motors equipped with PTC temperature sensors. The PTC temperature sensors are incorporated in the motor windings to measure the motor heating. This enables direct control and evaluation of the following operating conditions:

- heavy duty starting
- increased switching frequency
- single-phase operation
- high ambient temperature
- insufficient cooling
- break operation
- unbalance

The relay is independent of the rated motor current, the insulation class and the method of starting.

The PTC sensors are connected in series to the terminals T_a and T_b (or T_a and T_{bx} without short-circuit detection). The number of possible PTC sensors per measuring circuit is limited by the sum of the individual PTC sensor resistances: $R_G = R_1 + R_2 + R_N \leq 1.5 \text{ k}\Omega$.

Under normal operating conditions the resistance is below the response threshold. If only one of the PTC resistors heats up excessively, the output relay de-energizes. If the autoreset function is configured, the output relay energizes automatically after cooling down.

Devices with manual (pushbutton on front-side) or remote reset configuration have to be controlled via the control input by the required signal.

Further applications:

Temperature monitoring of equipment with PTC sensors integrated, such as

- machine rolling bearings,
- hot-air ventilators,
- oil,
- air,
- heating installations, etc.

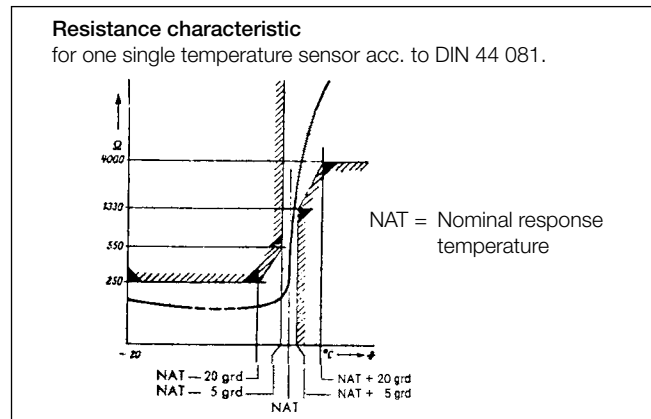

Selection table thermistor motor protection relays

Type	CM-MSE	CM-MSS (1)	CM-MSS (2)	CM-MSS (3)	CM-MSS (4)	CM-MSS (5)	CM-MSS (6)	CM-MSS (7)	CM-MSN
Function									
Measuring range									
Number of sensor circuits	1	1	1	1	1	1	2	3	6
Wire break monitoring	•	•	•	•	•	•	•	•	•
Short-circuit detection	-	-	-	• 1)	•	•	•	•	•
Non-volatile fault storage	-	-	-	-	• 2)	• 2)	-	• 2)	• 2)
Operation/Reset									
Auto reset	•	•	•	•	• 2)	• 2)	• 2)	• 2)	• 2)
Manual reset	-	-	•	•	•	•	•	•	•
Remote reset	-	-	•	•	•	•	•	•	•
Test button	-	-	-	-	•	•	•	•	•
Output contacts									
Operational principle	closed-circuit principle								
Number / type	1 c/o	1 c/o	2 c/o	2 c/o	1 n/o + 1 n/c	2 c/o	1 c/o per sensor circuit	1 n/o + 1 n/c accumulative evaluation	1 n/o + 1 n/c accumulative evaluation
Width of housing	22.5 mm								45 mm
Supply voltages and Reference codes									
24 V AC	1SVR550805R9300		1SVR430811R9300						
24 V AC/DC		1SVR430800R9100	1SVR430810R9300	1SVR430710R9300					
110-130 V AC	1SVR550800R9300		1SVR430811R0300	1SVR430711R0300					
220-240 V AC	1SVR550801R9300	1SVR430801R1100	1SVR430811R1300	1SVR430711R1300					
380-440 V AC				1SVR430711R2300					
24-240 V AC/DC					1SVR430720R0400	1SVR430720R0300	1SVR430710R0200	1SVR430720R0500	1SVR450025R0100

1) configurable via terminals

2) Auto reset without non-volatile fault storage configurable by permanent jumpering of connecting terminals S1-T2 or S1/X1-S2/X2

Thermistor motor protection relays

Product overview

CM-MSE

- Auto reset
- Connection of several sensors (max. 6 sensors conn. in series)
- Monitoring of bimetals
- 1 n/o contact
- Excellent cost / performance ratio

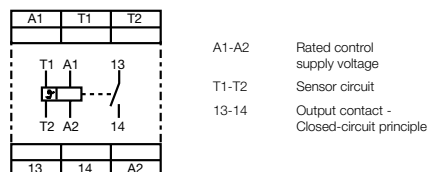

CM-MSS (1), 1 c/o contact

- Auto reset
- Connection of several sensors
- Monitoring of bimetals
- 1 c/o contact
- 2 LEDs for status indication

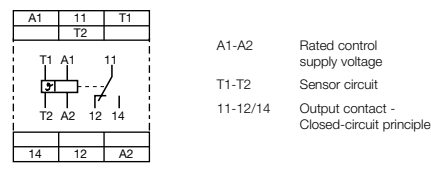

CM-MSS (2), 2 c/o contacts

- Fault storage can be switched off
- Auto reset configurable
- Reset button
- Remote reset
- Monitoring of bimetals
- 2 c/o contacts
- 2 LEDs for status indication

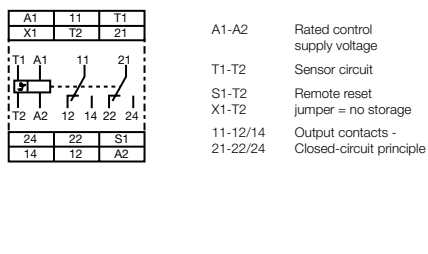

CM-MSS (3), 2 c/o contacts, short-circuit monitoring configurable

- Fault storage can be switched off
- Auto reset configurable
- Reset button
- Remote reset
- Monitoring of bimetals
- Short-circuit monitoring of the sensor circuit configurable
- 2 c/o contacts
- 2 LEDs for status indication

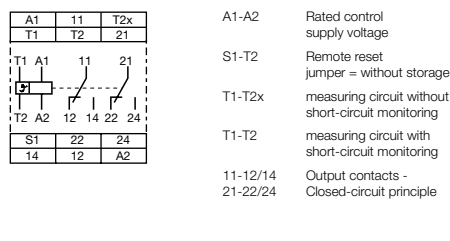

CM-MSS (4) + CM-MSS (5), 1-channel

- Short-circuit monitoring of the sensor circuit
- Wide supply voltage range: 24-240 V AC/DC
- Non-volatile fault storage selectable
- Reset and test button
- Remote reset
- Auto reset configurable
- Output contacts: 1 n/c and 1 n/o or 2 c/o contacts
- 2 LEDs for status indication

CM-MSS (4)

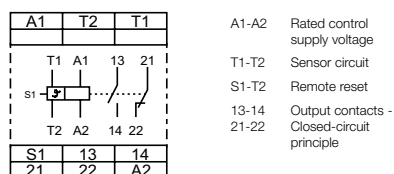

CM-MSS (5)

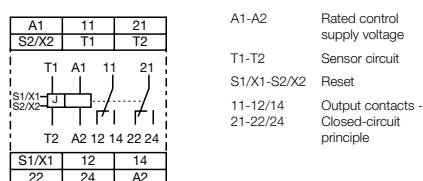

Thermistor motor protection relays

Product overview

6

CM-MSS (6), 2-channel, single evaluation

- Short-circuit monitoring for the sensor circuits
- Wide supply voltage range: 24-240 V AC/DC
- 2 separate sensor circuits for monitoring of two motors or one motor with 2 sensor circuits (prewarning and final switch off)
- Reset button
- Auto reset configurable
- Output contacts: 2 x 1 c/o contact
- 3 LEDs for status indication

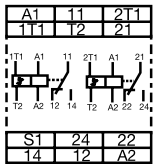

A1-A2 Rated control supply voltage
11-12/14, 21-22/24 Output contacts - Closed-circuit principle
1T1-T2 Sensor circuit
2T1-T2

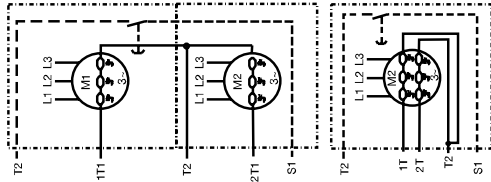

S1-T2 jumpered = no storage

CM-MSS (7), 3 sensor circuits, accumulative evaluation

- Short-circuit monitoring for the sensor circuits
- Wide supply voltage range: 24-240 V AC/DC
- Non-volatile fault storage configurable
- Remote reset
- Auto reset configurable
- Reset and test button
- Output contacts: 1 n/c and 1 n/o contact
- 4 LEDs for status indication

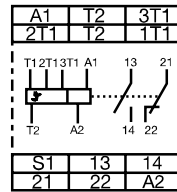

A1-A2 Rated control supply voltage
13-14 Output contacts - Closed-circuit principle

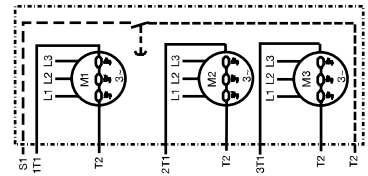

1T1-T2 Sensor circuits
2T1-T2, 3T1-T2
S1-T2 Remote reset jumpered = no storage

CM-MSN, 6 sensor circuits, accumulative evaluation

- Short-circuit monitoring of the sensor circuit
- Wide supply voltage range: 24-240 V AC/DC
- Non-volatile fault storage configurable
- Remote reset
- Auto reset configurable
- Reset and test button
- Output contacts: 1 n/c, 1 n/o contact
- 7 LEDs for status indication

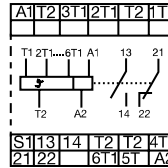

A1-A2 Rated control supply voltage
13-14 Output contacts - Closed-circuit principle

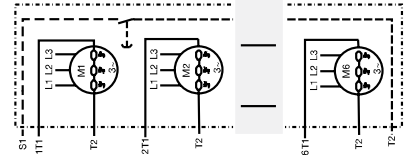

accumulative evaluation = if any input exceeds the threshold, the output relay will trip

Thermistor motor protection relays

Ordering details

Description

The thermistor motor protection relays CM-MSE, CM-MSS and CM-MSN are used to control motors equipped with PTC temperature sensors. The PTC temperature sensors are incorporated in the motor windings to measure the motor heating. This enables direct control and evaluation of various operating conditions. Depending on the products also ATEX approvals for use in hazardous areas are available.

ABB also offers PTC temperature sensors C011 (according to DIN 44081) which are suitable for embedding in motor windings.



CM-MSE



CM-MSS (5)



CM-MSN

Ordering details

Rated control supply voltage = measuring voltage	Reference code	Catalog number	Weight (1 pce) kg (lb)
24 V AC	CM-MSE	1SVR550805R9300	0.11 (0.24)
110-130 V AC		1SVR550800R9300	0.11 (0.24)
220-240 V AC	CM-MSS (1)	1SVR550801R9300	0.11 (0.24)
24 V AC/DC ¹⁾		1SVR430800R9100	0.15 (0.33)
220-240 V AC	CM-MSS (2)	1SVR430801R1100	0.15 (0.33)
24 V AC/DC ¹⁾		1SVR430810R9300	0.15 (0.33)
24 V AC		1SVR430811R9300	0.15 (0.33)
110-130 V AC		1SVR430811R0300	0.15 (0.33)
220-240 V AC	CM-MSS (3)	1SVR430811R1300	0.15 (0.33)
24 V AC/DC ¹⁾		1SVR430710R9300	0.15 (0.33)
110-130 V AC		1SVR430711R0300	0.15 (0.33)
220-240 V AC	CM-MSS (4) ²⁾	1SVR430711R1300	0.15 (0.33)
380-440 V AC		1SVR430711R2300	0.15 (0.33)
24-240 V AC/DC	CM-MSS (5) ³⁾	1SVR430720R0400	0.15 (0.33)
	CM-MSS (6)	1SVR430720R0300	0.15 (0.33)
	CM-MSS (7)	1SVR430710R0200	0.15 (0.33)
	CM-MSS (7)	1SVR430720R0500	0.15 (0.33)
	CM-MSN	1SVR450025R0100	0.23 (0.51)

¹⁾ Not electrically isolated

²⁾ CM-MSS (4): 1-channel 1 n/c, 1 n/o

³⁾ CM-MSS (5): 1-channel 2 c/o

Thermistor motor protection relays

Ordering details

PTC temperature sensors C011

Description



The PTC temperature sensors (temperature-dependent with positive temperature coefficient) are selected by the manufacturer of the motor depending on:

- the motor insulation class according to IEC/EN 60034-11,
- the special characteristics of the motor, such as the conductor cross-section of the windings, the permissible overload factor etc.
- special conditions prescribed by the user, such as the permissible ambient temperature, risks resulting from locked rotor, extent of permitted overload etc.

Temperature sensor characteristics

One temperature sensor must be embedded in each phase winding. For instance, in case of three-phase squirrel cage motors, three sensors are embedded in the stator windings. For pole-changing motors with one winding (Dahlander connection), 3 sensors are also sufficient. Pole-changing motors with two windings, however, require The sensors are suitable for embedding in motor windings with rated operating voltages of up to 600 V AC. Conductor length: 500 mm per sensor. A 14 V varistor can be connected in parallel to protect the sensors from overvoltage. Due to their characteristics, the thermistor motor protection relays can also be used with PTC temperature sensors of other manufacturers which comply with DIN 44 081 and DIN 44 082 6 sensors.

If an additional warning is required before the motor is switched off, separate sensors for a correspondingly lower temperature must be embedded in the winding. They have to be connected to a second control unit.

Ordering details

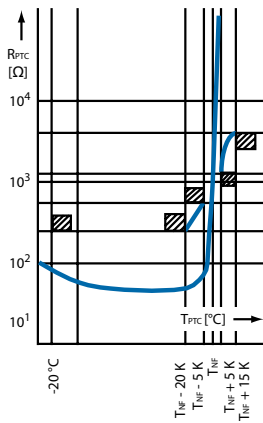

Rated response temperature T_{NF}	Color Coding	Reference code	Catalog number	Weight (1 pce) kg (lb)
70 °C	white-brown	C011-70 ¹⁾	GHC0110003R0001	0.02 (0.044)
80 °C	white-white	C011-80 ¹⁾	GHC0110003R0002	0.02 (0.044)
90 °C	green-green	C011-90 ¹⁾	GHC0110003R0003	0.02 (0.044)
100 °C	red-red	C011-100 ¹⁾	GHC0110003R0004	0.02 (0.044)
110 °C	brown-brown	C011-110 ¹⁾	GHC0110003R0005	0.02 (0.044)
120 °C	gray-gray	C011-120 ¹⁾	GHC0110003R0006	0.02 (0.044)
130 °C	blue-blue	C011-130 ¹⁾	GHC0110003R0007	0.02 (0.044)
140 °C	white-blue	C011-140 ¹⁾	GHC0110003R0011	0.02 (0.044)
150 °C	black-black	C011-150 ¹⁾	GHC0110003R0008	0.02 (0.044)
160 °C	blue-red	C011-160 ¹⁾	GHC0110003R0009	0.02 (0.044)
170 °C	white-green	C011-170 ¹⁾	GHC0110003R0010	0.02 (0.044)
150 °C	black-black	C011-3-150 ²⁾	GHC0110033R0008	0.05 (0.11)

¹⁾Temperature sensor C011, standard version acc. to DIN 44081

²⁾Triple temperature sensor C011-3

Thermistor motor protection relays

Technical information

PTC temperature sensors C011

Technical data

Characteristic data

	Sensor type C011
Cold-state resistance	50 -100 Ω at 25 °C
Warm-state resistance ± 5 up to 6 K of rated response temperature T_{NF}	10 000 Ω
Thermal time constant, sensor open ¹⁾	< 5 s
Permitted ambient temperature	+180 °C

Rated response temperature w tolerance TNF w iTNF	PTC resistance R from -20 °C to TNF - 20 K	PTC resistance R at PTC temperatures of:		
		TNF - iTNF (UPTC m 2.5 V)	TNF + iTNF (UPTC m 2.5 V)	TNF + 15 K (UPTC m 7.5 V)
70 ± 5 °C	$\leq 100 \Omega$	$\leq 570 \Omega$	$\geq 570 \Omega$	-
80 ± 5 °C		$\leq 550 \Omega$	$\geq 1330 \Omega$	$\geq 4000 \Omega$
90 ± 5 °C				
100 ± 5 °C				
110 ± 5 °C				
120 ± 5 °C				
130 ± 5 °C				
140 ± 5 °C				
150 ± 5 °C				
160 ± 5 °C		$\leq 570 \Omega$	$\geq 570 \Omega$	-
170 ± 7 °C				

¹⁾ Not embedded in windings.

²⁾ For triple temperature sensor take values x 3.

Thermistor motor protection relays

Technical data

6

Type	CM-MSE	CM-MSS	CM-MSN
Input circuit			
Rated control supply voltage U_s	A1-A2	24 V AC approx. 1.5 VA	
power consumption	A1-A2	24 V AC/DC approx. 1.1 VA / 0.6 W	
	A1-A2	110-130 V AC approx. 1.5 VA	
	A1-A2	220-240 V AC approx. 1.5 VA	
	A1-A2	380-440 V AC approx. 1.7 VA	
	A1-A2	24-240 V AC/DC approx. 1.4-1.7 W / approx. 3.5-5.7 VA	
Rated control supply voltage U_s tolerance		-15 % ... +10 %	
Rated frequency		AC: 50-60 Hz / 24-240 V AC/DC versions: 15-400 Hz	
Duty time		100 %	
Measuring circuit			
Monitoring function	T1-T2	T1-T2/T2x, 1T1...6T1-T2	1T1...6T1-T2
Number of sensor circuits	1	1, 2 oder 3 (see order details)	6
Short-circuit monitoring	-	see ordering details	yes
Non-volatile fault storage	-	see ordering details	configurable
Test function	-	see ordering details	yes
Sensor circuit			
Temperature threshold (relay de-energizes)	2.7-3.7 k Ω	CM-MSS (1+2): 3050 \pm 550 Ω	3.6 k Ω \pm 5 %
Temperature hysteresis (relay energizes)	1.7-2.3 k Ω	CM-MSS (3-7): 3.6 k Ω \pm 5 % CM-MSS (1+2): 1900 \pm 400 Ω CM-MSS (3-7): 1.6 k Ω \pm 5 %	1.6 k Ω \pm 5 %
Short-circuit threshold (relay de-energizes)		<18 Ω	
Short-circuit hysteresis (relay energizes)		>45 Ω	
Maximum total resistance of sensors connected in series (cold state)		\leq 1.5 k Ω	
Maximum sensor cable length for short-circuit detection		2 x 100 m at 0.75 mm ² , 2 x 400 m at 2.5 mm ²	
Response time		<100 ms	
Control circuit for storage and hysteresis function			
Remote reset	S1-T2 or S1/X1-S2/X2	-	n/o contact
Maximum no-load voltage			approx. 25 V, 24-240 V; AC/DC versions: 5.5 V
Maximum cable length			\leq 50 m, 100-200 m if shielded
Indication of operational states			
Control supply voltage	U: green LED	-	L: control supply voltage applied
Fault indication	F: red LED	-	O: output relay de-energized
Output circuits			
Kind of output	13-14	11-12/14, 21-22/24, 13-14, 21-22	13-14, 21-22
Operational principle	1 n/o contact	CM-MSS (1): 1 c/o contact CM-MSS (2,3,5): 2 c/o contacts CM-MSS (4, 7): 1 n/o + 1 n/c CM-MSS (6): 2x1 c/o contact	1 n/o + 1 n/c contact
Contact material	AgCdO	CM-MSS (1+2+6): AgCdO CM-MSS (3+4+5+7): AgNi	AgNi
Rated voltage (VDE 0110, IEC 664-1, IEC 60947-1)		250 V	
Maximum switching voltage		250 V	
Rated operational current I_o (IEC/EN 60947-5-1)	AC12 (resistive) at 230 V AC15 (inductive) at 230 V DC12 (resistive) at 24 V DC13 (resistive) at 24 V	4 A 3 A 4 A 2 A (1.5 A - n/c contact ¹⁾)	
AC rating (UL 508)	Utilization category (Control Circuit Rating Code) max. rated operational voltage max. continuous thermal current at B 300 max. making/breaking apparent power at B300	300 V AC 5 A 3600/360 VA	
Mechanical lifetime		30 (10 ¹¹) x 10 ⁹ switching cycles	
Electrical lifetime (AC12, 230 V, 4 A)		0.1 x 10 ⁶ switching cycles	
Max. fuse rating to achieve short-circuit protection	n/c contact n/o contact	10 A fast-acting 10 A fast-acting	4 A (10 A ¹⁾) fast-acting 6 A (10 A ¹⁾) fast-acting
			10 A fast-acting 10 A fast-acting
General data			
Dimensions (W x H x D)	22.5 x 78 x 78.5 mm (0.89 x 3.07 x 3.09 in)	22.5 x 78 x 100 mm (0.89 x 3.07 x 3.94 in)	45 x 78 x 100 mm (1.77 x 3.07 x 3.94 in)
Weight	approx. 0.11 kg (0.24 lb)	approx. 0.15 kg (0.33 lb)	approx. 0.23 kg (0.51 lb)
Mounting position	housing / terminals	any	
Degree of protection	operation	IP50 / IP20	
Ambient temperature range	storage	-20...+60 $^{\circ}$ C	-25...+65 $^{\circ}$ C
Mounting		-40...+85 $^{\circ}$ C DIN rail (IEC/EN 60715)	

¹⁾ 1SVR 430 710 R 0200, 1SVR 430 8xx R xxxx

Thermistor motor protection relays

Technical data

Type		CM-MSE	CM-MSS	CM-MSN
Electrical connection				
Wire size	fine strand with wire end ferrule	2 x 1.5 mm ² (2 x 16 AWG)		2 x 2.5 mm ² (2 x 14 AWG)
	fine strand without wire end ferrule	2 x 0.75-1.5 mm ² (2 x 18-16 AWG)		2 x 0.75-2.5 mm ² (2 x 18-14 AWG)
	rigid	2 x 1-1.5 mm ² (2 x 18-16 AWG)		2 x 0.75-2.5 mm ² (2 x 18-14 AWG)
Stripping length		2 x 0.75-1.5 mm ² (2 x 18-16 AWG)		2 x 0.5-4 mm ² (2 x 20-12 AWG)
Tightening torque		10 mm (0.39 inch)		7 mm (0.28 inch)
Standards				
Product standard		IEC 255-6, EN 60255-6		
Low Voltage Directive		2006/95/EC		
EMC Directive		2004/108/EC, 91/263/EEC, 92/31/EEC, 93/68/EEC, 93/67/EEC		
Electromagnetic compatibility				
electrostatic discharge	IEC/EN 61000-4-2	EN 61000-6-2, EN 61000-6-4		
radiated, radio-frequency, electromagnetic field	IEC/EN 61000-4-3	Level 3 (6 kV / 8 kV)		
electrical fast transient /burst	IEC/EN 61000-4-4	Level 3 (10 V/m)		
surge	IEC/EN 61000-4-5	Level 3 (2 kV / 5 kHz)		
conducted disturbances, induced by radio-frequency fields	IEC/EN 61000-4-6	Level 3/4 (1/2 kV)		
Operational reliability (IEC 68-2-6)		6 g	4 g	5 g
Resistance to vibration (IEC 68-2-6)		10 g	6 g	10 g
Environmental testing (IEC 68-2-30)		24 h cycle time, 55 °C, 93 % rel., 96 h		
Isolation data				
Rated voltage between supply, measuring and output circuit		250 V		
Rated impulse withstand voltage between all isolated circuits		4 kV / 1.2 - 50 µs		
Test voltage between all isolated circuits		2.5 kV, 50 Hz, 1 min.		
Pollution degree		3		
Overvoltage category		III		

Notes

CM-E Range Temperature monitoring relays



Temperature monitoring relays





New range of temperature monitoring relays CM-TCS

The new CM-TCS temperature monitoring relays replace the existing C510 and C511 range. The number of models has been reduced in order to make selection and stocking easier. All products now feature over-temperature and under-temperature monitoring. Also, units are now configurable to open or closed circuit principle.

6 The temperature monitoring relays CM-TCS monitor overtemperature, undertemperature or temperatures between threshold values (window monitoring) with PT100 sensor. As soon as the temperature falls below or exceeds the threshold value the output relays change their positions according to the configured functionality and the front-face LED's display the current status.

Characteristics CM-TCS

- Adjustable sensor type: PT100
- Functionality like overtemperature monitoring, undertemperature monitoring, temperature window monitoring configurable
- All configurations and adjustments by front-face operating elements
- Precise adjustment with direct reading scales
- One or two threshold values
- Hysteresis 2...20 % adjustable
- Operating temperature range -40...+60 °C
- 1 x 2 c/o or 2 x 1 c/o configurable
- Open- or closed-circuit principle configurable
- Short-circuit monitoring and interrupted wire detection
- 22.5 mm (0.89 in) width
- LED's for status indication

Characteristics C512 + C513

- Adjustable sensor types: PT100, PT1000, KTY83, KTY84, NTC-B57227-K333-A1
- Measuring principle for 2-wire and 3-wire sensors
- Temperature monitor for 1-3 sensor circuits
- Adjustable over-, undertemperature monitoring or range monitoring function
- 2 thresholds
- Hysteresis for both thresholds (1-99 Kelvin)
- Adjustable time delay from 0-999 s affects to both thresholds
- Storage function selectable via external signal (Y1-Y2)
- Non volatile storage of parameter settings
- 1 n/o (for wire-break and short-circuit detection) and 2 c/o
- Multifunctional digital display
- 3 LED's for status indication
- Open- or closed-circuit principle selectable
- 45 mm wide housing with 24 terminals

C512

- Temperature monitor for 1 sensor circuit

C513

- Temperature monitor for 1-3 sensor circuits
- In the 3-sensor version the status of the single sensors is displayed if the temperature exceeds or falls below the threshold.

This way it can be easily determined which one of the connected sensors has exceeded or dropped below either one or both threshold values.

Temperature monitoring relays

Ordering details



Description

Acquisition, messaging and regulation of temperatures of solid, liquid and gaseous media in processes and machines via PT100, PT1000, KTY83, KTY84 or NTC sensors.

ABB offers different temperature monitoring relays to meet the needs of your application:



CM-TCS



C512, C513

Ordering details - Temperature monitoring relays

Rated control supply voltage	Measuring range	Reference code	Catalog number	Weight (1 pce) kg (lb)
24-240 V AC/DC	-50...+50 °C	CM-TCS.11 ¹⁾	1SVR630740R0100	0.127 (0.281)
	0...+100 °C	CM-TCS.12 ¹⁾	1SVR630740R0200	0.127 (0.281)
	0...+200 °C	CM-TCS.13 ¹⁾	1SVR630740R0300	0.127 (0.281)
24 V AC/DC	-50...+50 °C	CM-TCS.21 ¹⁾	1SVR630740R9100	0.141 (0.310)
	0...+100 °C	CM-TCS.22 ¹⁾	1SVR630740R9200	0.141 (0.310)
	0...+200 °C	CM-TCS.23 ¹⁾	1SVR630740R9300	0.141 (0.310)
24 V AC/DC	-50...+500 °C *)	C512-24 ²⁾	1SAR700100R0005	0.32 (0.71)
24-240 V AC/DC		C512-W ²⁾	1SAR700100R0010	0.33 (0.73)
24-240 V AC/DC		C513-W ²⁾	1SAR700110R0010	0.34 (0.75)

¹⁾ PT100 sensors, 2 or 3 wire connection, 2 thresholds adjustable

²⁾ PT100, PT1000, KTY83, KTY84, NTC-B57227-K333-A1, 2 or 3 wire connection, 2 thresholds, multifunctional display.

Open or closed circuit principle adjustable, 1 n/o, 2 c/o contacts

(Typ Siemens Matsushita B57272-A333-A1 - 100 °C: 1.8 kΩ, 25 °C: 32.762 kΩ)

Ordering details - New range temperature monitoring relays

Rated control supply voltage	Measuring range	Reference code	Catalog number	Weight (1 pce) kg (lb)
24-240 V AC/DC	-50...+50 °C	CM-TCS.11S	1SVR730740R0100	0.151 (0.333)
		CM-TCS.11P	1SVR740740R0100	0.140 (0.309)
	0...+100 °C	CM-TCS.12S	1SVR730740R0200	0.151 (0.333)
		CM-TCS.12P	1SVR740740R0200	0.140 (0.309)
	0...+200 °C	CM-TCS.13S	1SVR730740R0300	0.151 (0.333)
		CM-TCS.13P	1SVR740740R0300	0.140 (0.309)
24 V AC/DC	-50...+50 °C	CM-TCS.21S	1SVR730740R9100	0.138 (0.304)
		CM-TCS.21P	1SVR740740R9100	0.127 (0.280)
	0...+100 °C	CM-TCS.22S	1SVR730740R9200	0.138 (0.304)
		CM-TCS.22P	1SVR740740R9200	0.127 (0.280)
	0...+200 °C	CM-TCS.23S	1SVR730740R9300	0.138 (0.304)
		CM-TCS.23P	1SVR740740R9300	0.127 (0.280)

Ordering details - Replaceable cover marking for digital devices

Use for	Language	Reference code	Catalog number	Weight (1 pce) kg (lb)
C512	German	C512-D	1SVR700101R0100	
C512	English	C512-E	1SVR700102R0100	
C513	German	C513-D	1SVR700111R0100	
C513	English	C513-E	1SVR700112R0100	

*) The measuring range depends on the used sensor type:

- PT100: -50...+500 °C
- PT1000: -50...+500 °C
- NTC: +80...+160 °C
- KTY83: -50...+175 °C
- KTY84: -40...+300 °C

(Typ Siemens Matsushita B57272-A333-A1 - 100 °C: 1.8 kΩ, 25 °C: 32.762 kΩ)

Temperature monitoring relays

Overview, functional description and diagrams



Overview

The temperature monitoring relays can be used for temperature measurement in solid, liquid and gaseous media. The temperature is acquired by the sensor in the medium, evaluated by the device and monitored to determine whether it is within an operating range (range monitoring function) or has exceeded or fallen below a threshold.

Functional description

CM-TCS

The temperature monitoring relays CM-TCS monitor overtemperature, undertemperature, or temperatures between two threshold values (window monitoring) with PT100 sensor. As soon as the temperature falls below or exceeds the threshold value the output relays change their positions according to the configured functionality and the front-face LEDs display the current status. Regardless of the selected configuration, the device is monitoring its measuring circuit for interrupted wires or short-circuits.

DIP switches

Position	4	3	2	1
ON †	2x1 c/o	closed		
OFF	1x2 c/o	open		

Function diagrams

CM-TCS - Overvoltage

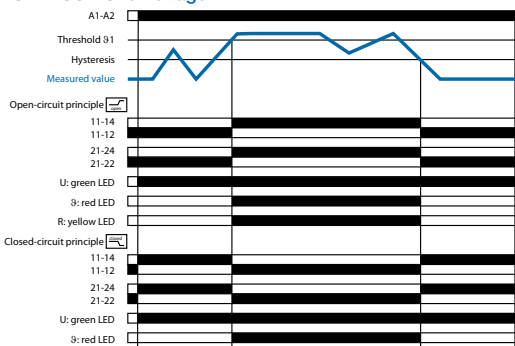

CM-TCS - Undervoltage

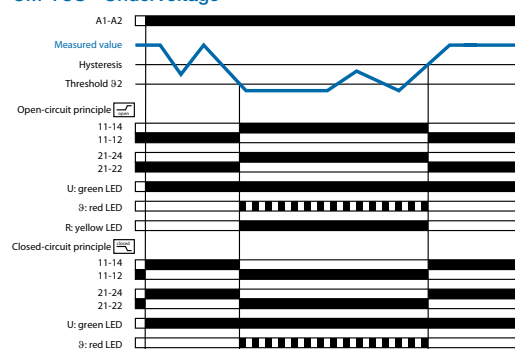

CM-TCS - Temperature monitoring

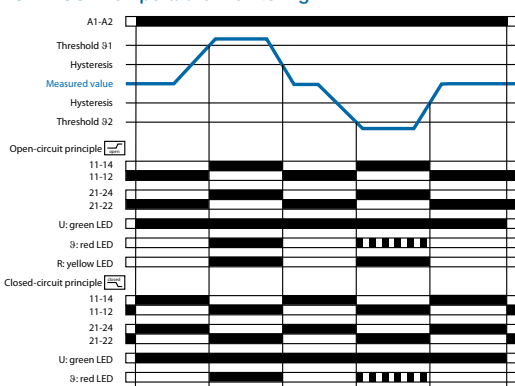

	ON	OFF (default)
DIP switch 1 Monitoring principle	Overtemperature monitoring <input checked="" type="checkbox"/> If overtemperature monitoring is selected, the CM-TCS recognizes temperatures above the selected threshold and trips the output relay according to the selected operating principle.	Undertemperature monitoring <input checked="" type="checkbox"/> If undertemperature monitoring is selected, the CM-TCS recognizes temperatures below the selected threshold and trips the output relay according to the selected operating principle.
DIP switch 2 Temperature window monitoring	Temperature window monitoring activated <input checked="" type="checkbox"/> If temperature window monitoring is selected, the CM-TCS monitors over- and undertemperature. If temperature window monitoring is activated, DIP switch 1 is disabled.	Temperature window monitoring de-activated <input checked="" type="checkbox"/> Temperature window monitoring is de-selected.
DIP switch 3 Operating principle of the output relays	Closed-circuit principle <input checked="" type="checkbox"/> If closed-circuit principle is selected, the output relays are energized. They de-energize if a fault is occurring.	Open-circuit principle <input checked="" type="checkbox"/> If open-circuit principle is selected, the output relays are deenergized. They energize if a fault is occurring.
DIP switch 4 2 x 1 c/o contact, 1 x 2 c/o contacts	2 x 1 c/o (SPDT) contact <input checked="" type="checkbox"/> If operating principle 2 x 1 c/o contact is selected, the output relay R1 (11-12/14) reacts to threshold value t_1 and the output relay R2 (21-22/24) reacts to threshold value t_2 .	1 x 2 c/o (SPDT) contacts <input checked="" type="checkbox"/> If operating principle 1 x 2 c/o contacts is selected, both output relays R1 (11-12/14) and R2 (21-22/24) react synchronously to one threshold value. Overtemperature monitoring: Settings of the threshold value t_2 have no effect on the operation. Undertemperature monitoring: Settings of the threshold values t_2 have no effect on the operation.

Temperature monitoring relays

Overview, functional description and diagrams



Functional description

Digital tripping devices

Once the temperature has reached the set threshold of u_1 , output relay K1 changes its switching state after the set time delay t has elapsed (K2 reacts in the same way for u_2).

Function diagrams

Overtemperature - C512/C513

Open-circuit principle

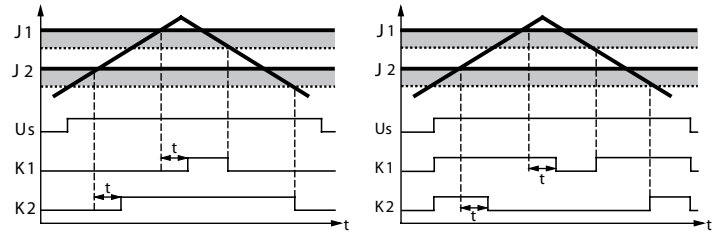

Undertemperature - C512/C513

Open-circuit principle

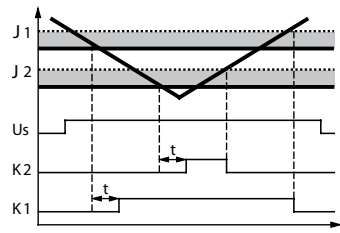

Closed-circuit principle

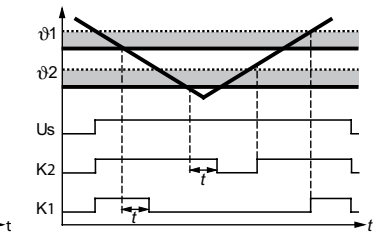

Characteristic curves of resistance sensors

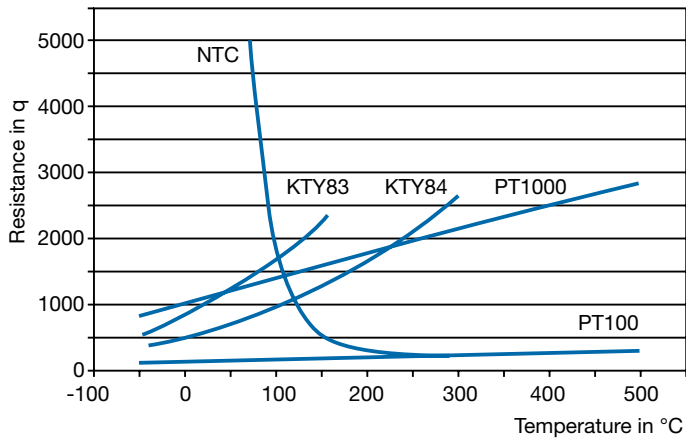

Range monitoring - C512/C513

Open-circuit principle

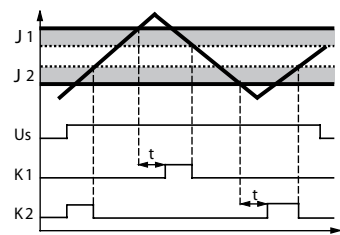

Closed-circuit principle

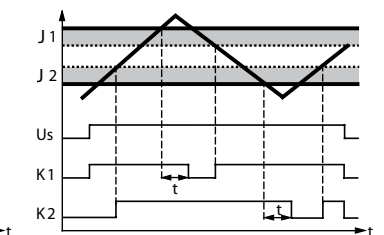

Function principle with storage function - C512/C513

using overtemperature with closed-circuit principle as an example

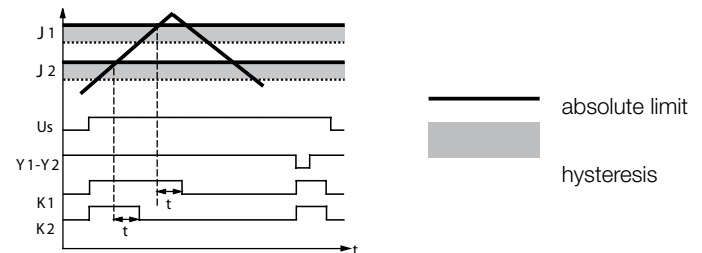

NEW

Temperature monitoring relays

Connection diagrams, resistance thermometer sensors

Connection diagrams

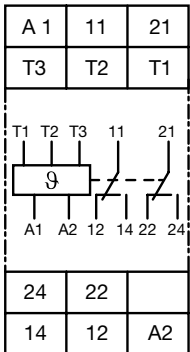

CM-TCS

- A1-A2 Control supply voltage
- 11-12/14 Output relay R1
- 21-22/24 Output relay R2
- T1, T2, T3 Measuring input, connection PT100

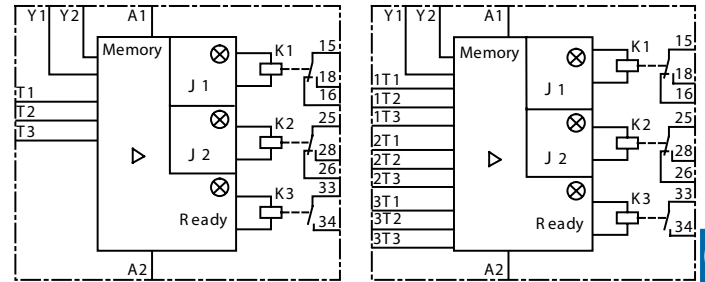

C512

- | | | | |
|----------|-------------------------------|----------|-------------------------------|
| A1-A2 | Rated control supply voltage | A1-A2 | Rated control supply voltage |
| 15-16/18 | Output contacts | 15-16/18 | Output contacts |
| 25-26/28 | | 25-26/28 | |
| 33-34 | | 33-34 | |
| T1-T3 | Sensor connection | 1T1-1T3 | Sensor connection 1 |
| Y1-Y2 | Connection for storage bridge | 2T1-2T3 | Sensor connection 2 |
| | | 3T1-3T3 | Sensor connection 3 |
| | | Y1-Y2 | Connection for storage bridge |

Connection of resistance thermometer sensors

2-wire measurement

When using 2-wire temperature sensors the sensor resistance and the wire resistance are added together.

The resulting systematic errors must be taken into account when adjusting the tripping device.

A jumper must be connected between the terminals T2 and T3.

The following table can be used for PT100 sensors to determine the temperature errors caused by the line length.

When using resistance sensors with two-wire connection a bridge must be inserted between terminals T2 and T3.

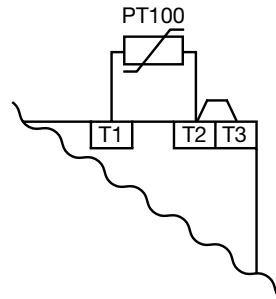

3-wire measurement

To minimize the influence of the wire resistance, a three-wire connection is usually used.

By means of the additional wire two measuring circuits are created. One of these two circuits is used for reference. This way, the tripping device can calculate and take into account the wire resistance automatically.

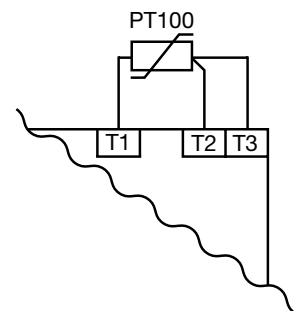

Error caused by the line

The error resulting from the line resistance amounts to approx. 2.5 Kelvin/Ohm. If the resistance of the line is not known and it is not possible to measure it, the error caused by the line can be estimated using the following table.

Temperature error

(depending on the line length and conductor cross section for PT100 sensors at an ambient temperature of 20 °C, in K)

Line length in m	Wire size mm ²			
	0.50	0.75	1	1.5
0	0.0	0.0	0.0	0.0
10	1.8	1.2	0.9	0.6
25	4.5	3.0	2.3	1.5
50	9.0	6.0	4.5	3.0
75	13.6	9.0	6.8	4.5
100	18.1	12.1	9.0	6.0
200	36.3	24.2	18.1	12.1
500	91.6	60.8	45.5	30.2

Type		CM-TCS.11/12/13	CM-TCS.21/22/23
Input circuit			
Rated control supply voltage	U_s	A1-A2	24-240 V AC/DC
Rated control supply voltage U_s tolerance			-15...+10 %
Typical current / power / consumption			
		24 V DC	33 mA / 0.8 VA
		115 V AC	12.5 mA / 1.5 VA
		230 V AC	13 mA / 2.9 VA
Rated frequency		AC	13.5-440 Hz
Frequency range		AC	13.5-440 Hz
Power failure buffering time		min.	20 ms
			24 V AC/DC
			18 mA / 0.45 VA
			n/a
			n/a
			50/60 Hz
			45-65 Hz
6 Measuring circuit			
Sensor type			T1, T2, T3
Connection of the sensor			PT100
		2-wire	yes, jumper between T2-T3
		3-wire	yes, use terminal T1, T2, T3
Monitoring function			overtemperature, undertemperature or window monitoring
Threshold values adjustable within the measuring range		CM-TCS.x1	-50...+50 °C
		CM-TCS.x2	0...+100 °C
		CM-TCS.x3	0...+200 °C
Number of possible thresholds			2
Tolerance of the adjusted threshold value			typ. ±5 % of the range end value
Hysteresis related to the threshold value			2-20 % of threshold value, min. 1 °C
Measuring principle			continuous current
Typical current in the sensor circuit			0.8 mA
Interrupted wire detection			yes, indicated via LED status
Short-circuit detection			yes, indicated via LED status
Accuracy within the rated control supply voltage tolerance			< 0.2 °C / or < 0.01 %/K
Accuracy within the temperature range			< 0.2 °C / or < 0.01 %/K
Repeat accuracy (constant parameters)			< 0.2 % of full scale
Maximum measuring cycle			320 ms
Output circuit			
Kind of output			2 x 1 or 1 x 2 c/o (SPDT) contacts configurable
Operating principle ¹⁾			open- or closed-circuit principle configurable
Contact material			AgNi alloy, Cd free
Rated voltage (VDE 0110, IEC 60947-1)			250 V AC / 300 V DC
Minimum switching voltage / Minimum switching current			24 V / 10 mA
Maximum switching voltage / Maximum switching current			see 'Load limit curves'
Rated operating current I_n (IEC/EN 60947-1-5)		AC12 (resistive) 230 V	4 A
		AC15 (inductive) 230 V	3 A
		DC12 (resistive) 24 V	4 A
		DC13 (inductive) 24 V	2 A
AC Rating (UL508)		utilization category	B 300, pilot duty general purpose (250 V, 4 A, cos φ 0.75)
		maximum rated operational voltage	250 V AC
		maximum continuous thermal current at B 300	4 A
		maximum making/breaking apparent power at B 300	3600/360 VA
Mechanical lifetime			30 x 10 ⁶ switching cycles
Electrical lifetime ((AC12, 230 V, 4 A)			0.1 x 10 ⁶ switching cycles
Maximum fuse rating to achieve short-circuit protection		n/c contact	6 A fast-acting
		n/o contact	10 A fast-acting
Conventional thermal current I_{th} acc. IEC/EN 60947-1			4 A
General data			
Dimensions (W x H x D)			22.5 x 78 x 100 mm (0.89 x 3.07 x 3.94 in)
Mounting position			any
Weight		net weight	0.141 kg (0.310 lb)
		gross weight	0.166 kg (0.336 lb)
		enclosure / terminals	IP50 / IP20
Degree of protection		operation	-40...+60 °C
Ambient temperature range		storage/transport	-40...+85 °C
Mounting			DIN rail (IEC/EN 60715), snap-on mounting without any tool

Temperature monitoring relays

Technical data

NEW

Measuring & monitoring relays
CM Range

Type		CM-TCS.11/12/13	CM-TCS.21/22/23
Electrical connection			
Wire size	rigid	2 x 0.5-4 mm ² (2 x 20-12 AWG)	
	fine-strand with wire end ferrule	2 x 0.75-2.5 mm ² (2 x 18-14 AWG)	
Stripping length		7 mm (0.28 in)	
Tightening torque		0.6-0.8 Nm (5.31-7.08 lb.in)	
Electrical connection for devices in new housing			
Wire size	rigid	Screw connection technology	Easy Connect Technology (Push-in)
		1 x 0.5-2.5 mm ² (1 x 20-14 AWG)	2 x 0.5-1.5 mm ² (2 x 20-16 AWG)
		2 x 0.5-1.5 mm ² (2 x 20-16 AWG)	
	fine-strand with wire end ferrule	1 x 0.5-4 mm ² (1 x 20-12 AWG)	2 x 0.5-1.5 mm ² (2 x 20-16 AWG)
		2 x 0.5-2.5 mm ² (2 x 20-14 AWG)	
Stripping length		8 mm (0.32 in)	8 mm (0.32 in)
Tightening torque		0.6-0.8 Nm (5.31-7.08 lb.in)	-
Standards			
Product standard		IEC/EN 60255-6: 2008	
Other standards		EN 50178, IEC/EN 60204	
Low Voltage Directive		2006/95/EC	
EMC Directive		2004/108/EC	
RoHS Directive		2002/95/EC	
Environmental data			
Ambient temperature ranges	operation/storage/ transport	-40...+60°C/-40...+85°C/-40...+85°C	
Climatic category		3K5 (no condensation, no ice formation)	
Damp heat, cyclic		6 x 24 h cycle, 55 °C, 95 % RH	
Vibration, sinusoidal		Class 2	
Shock		Class 2	
Isolation data			
Rated impulse withstand voltage U _{imp} between all isolated circuits (IEC/EN 60947-1, IEC/EN 60664-1, VDE 0110-1)	supply circuit / measuring circuit	4 kV	-
	supply circuit / output circuits	4 kV	
	measuring circuit / output circuits	4 kV	
	output circuit 1 / output circuit 2	4 kV	
Pollution degree (IEC/EN 60664-1, VDE 0110-1)		3	
Overvoltage category (IEC/EN 60664-1, VDE 0110-1)		III	
Rated insulation voltage U _i (IEC/EN 60947-1, IEC/EN 60664-1, VDE 0110-1)	supply circuit / measuring circuit	300 V	-
	supply circuit / output circuits	300 V	
	measuring circuit / output circuits	300 V	
	output circuit 1 / output circuit 2	300 V	
Basis isolation for rated control supply voltage (IEC/EN 60664-1, VDE 0110-1)	supply circuit / measuring circuit	250 V AC / 300 V DC	-
	supply circuit / output circuits	250 V AC / 300 V DC	
	measuring circuit / output circuits	250 V AC / 300 V DC	
	output circuit 1 / output circuit 2	250 V AC / 300 V DC	
Protective separation (IEC/EN 61140, IEC/EN 50178)	supply circuit / measuring circuit	250 V AC / 250 V DC	-
	supply circuit / output circuits	250 V AC / 300 V DC	250 V AC / 250 V DC
	measuring circuit / output circuits	250 V AC / 300 V DC	250 V AC / 250 V DC
Test voltage between all isolated circuits, routine test (IEC/EN 60255-5, IEC/EN 61010-1)	supply circuit / measuring circuit	2.0 kV, 50 Hz, 1 s	-
	supply circuit / output circuits	2.0 kV, 50 Hz, 1 s	
	measuring circuit / output circuits	2.0 kV, 50 Hz, 1 s	
Test voltage between all isolated circuits, type test (IEC/EN 60255-5)	supply circuit / measuring circuit	4.0 kV, 50 Hz, 1 s	-
	supply circuit / output circuits	4.0 kV, 50 Hz, 1 s	
	measuring circuit / output circuits	4.0 kV, 50 Hz, 1 s	
Electromagnetic compatibility			
Interference immunity to		IEC/EN 61000-6-1, IEC/EN 61000-6-2, IEC/EN 61326-2-4	
electrostatic discharge	IEC/EN 61000-4-2	Level 3, 6 kV / 8 kV	
radiated, radio-frequency, electromagnetic field	IEC/EN 61000-4-3	Level 3, 10 V/m (1 GHz) / 3 V/m (2 GHz) / 1 V/m (2.7 GHz)	
electrical fast transient/burst	IEC/EN 61000-4-4	Level 3, 2 kV / 5 kHz	
surge	IEC/EN 61000-4-52	Level 3, installation class 3, supply circuit and measuring circuit 1 kV L-L, 2 kV L-earth	
conducted disturbances, induced by radio-frequency fields	IEC/EN 61000-4-6	Level 3, 10 V	
voltage dips, short interruptions and voltage variations	IEC/EN 61000-4-11	Level 3	
harmonics and interharmonics	IEC/EN 61000-4-13	Level 3	
Interference emission		EN 61000-6-3, EN 61000-6-4	
high-frequency radiated	IEC/CISPR 22, EN 50022	Class B	
high-frequency conducted	IEC/CISPR 22, EN 50022	Class B	

6

Temperature monitoring relays

Technical data

Type		C512	C513
Input circuit			
Rated control supply voltage	U_s	A1-A2 24 V AC/DC	A1-A2 24-240 V AC/DC
Power consumption		AC < 7 VA DC < 4 W	
Rated control supply voltage U_s tolerance			-15...+10 %
Rated frequency		AC	
Sensor circuit			
Sensor type		PT100, PT1000, KTY83, KTY84, NTC	
Sensor current		PT100 typ. 1 mA	PT1000, KTY83, KTY84, NTC typ. 0,2 mA
Wire-break detection		yes (not for NTC)	
Short-circuit detection		yes	
3-wire connection		yes (2-wire connection of sensors with terminals T2 and T3 bridged)	
Measuring circuit			
Setting accuracy at $T_a = 20\text{ °C}$ (T_{20})		< $\pm 2\text{ K} \pm 1\text{digit}$	
Accuracy within the temperature range		0.05 °C / °C deviation from T_{20}	
Response time		500 ms	
Hysteresis settings	temperature 1	1-99 kelvin	
	temperature 2	1-99 kelvin	
Tripping delay		0-999 s	
Output circuit			
Kind of output		2 c/o + 1n/o	2 c/o + 1 n/o
Rated operating current I_b (IEC/EN 60947-1-5)	AC12 (resistive) 230 V	3 A	
	AC15 (inductive) 230 V	1 A	
	DC12 (resistive) 24 V	0,1 A	
	DC13 (inductive) 24 V	0,1 A	
Mechanical lifetime		30 x 10 ⁶ switching cycles	
Electrical lifetime (AC15 at 3 A)		0.1 x 10 ⁵ switching cycles	
Max. fuse rating to achieve short-circuit protection		4 A, operating class gL/gG	
General data			
Dimensions (W x H x D)		45 x 105.9 x 86 mm (1.77 x 4.17 x 3.39 in)	
Tightening torque		0.8-1.2 Nm	
Mounting position		any	
Degree of protection	enclosure / terminals	IP 40 / IP 20	
Ambient temperature range	operation	-25...+60 °C	
	storage	-40...+80 °C	
Mounting		DIN rail (IEC/EN 60715)	
Electrical connection			
Wire size	rigid	1 x 4 mm ² (1 x 12 AWG), 2 x 2.5 mm ² (2 x 14 AWG)	
	fine-strand with wire end ferrule	1 x 2.5 mm ² (1 x 14 AWG), 2 x 1.5 mm ² (2 x 16 AWG)	
Standards			
Environmental conditions		IEC 60721-3-3	
Low Voltage Directive		IEC 60947-5-1, VDE 0660	
Electromagnetic compatibility	Interference immunity	EN 61000-6-2	
	Interference emission	EN 61000-6-4	
Vibration resistance (IEC 68-2-6)		5-26 Hz / 0.75 mm	
Shock resistance (IEC 68-2-27)		15 g / 11 ms	
Isolation data			
Rated insulation voltage		300 V AC	
Pollution degree		3	



CM-E Range Liquid level monitors & controls



Liquid level monitors and controls

Benefits and advantages

CM-ENE MIN/MAX

- Monitoring of pump systems for dry running (ENE MIN) and overflow (ENE MAX)
- Connection of 2 electrodes possible at C and MIN/MAX
- 3 supply voltage versions
- Optimal price/performance ratio
- 1 n/o contact: Open-circuit principle for CM-ENE MIN, Closed-circuit principle for CM-ENE MAX
- LED for status indication

CM-ENS

- 6**
- Monitoring and control of liquid levels (when draining or filling liquids in tanks)
 - Monitoring and control of mixture ratios (conductivity of liquids)
 - Adjustable response sensitivity 5-100 kq
 - 4 supply voltage versions 24 - 415 V AC
 - Version with protective separation acc. to VDE 0160 J
 - Cascadable
 - 1 c/o contact or 1 n/o and 1 n/c contact
 - 2 LEDs for status indication

CM-ENS UP/DOWN

- Monitoring and control of liquid levels
- Selectable function "fill" or "drain"
- Adjustable response sensitivity 5-100 kq
- Cascadable
- 1 c/o contact
- 2 LEDs for status indication

CM-ENN

- Monitoring and control of liquid levels (when emptying or filling liquids in tanks)
- Monitoring and control of mixture ratios (conductivity of liquids)
- 3 response sensitivities from 250 q - 500 kq in one unit
- 5 supply voltage versions 24 V AC/DC - 415 V AC
- Selectable ON- or OFF-delay 0.1-10 s
- 2 c/o contacts
- 2 LEDs for status indication

CM-ENN UP/DOWN

- Liquid level relay with 5 electrode inputs
- Level control with integrated overflow and dry-running protection
- Adjustable response sensitivity 5-100 kq
- Cascadable
- 1 c/o contact and 2 n/c contacts as alarm outputs
- 4 LEDs for status indication

Response sensitivity	Max. electrode current	Max. cable capacity	Max. cable length
250 Ω - 5 k Ω	8 mA	200 nF	1000 m
2.5-50 k Ω	2 mA	20 nF	100 m
25-500 k Ω	0.5 mA	4 nF	20 m

Liquid level monitors and controls

Ordering details

Description

ABB's liquid level monitoring relays for regulation and control of liquid levels and ratios of mixtures of conductive fluids.

The assortment includes single function and multifunction monitoring relays which can be used for over flow and dry-running protection, for filling and draining applications, for max and min alarm or any combination of such functions. Furthermore, a wide range of accessories is available.

Ordering details

Rated control supply voltage	Reference code	Catalog number	Weight (1 pce) kg (lb)
24 V AC	CM-ENE MIN	1SVR550855R9500	0.15 (0.33)
110-130 V AC		1SVR550850R9500	0.15 (0.33)
220-240 V AC		1SVR550851R9500	0.15 (0.33)
24 V AC	CM-ENE MAX	1SVR550855R9400	0.15 (0.33)
110-130 V AC		1SVR550850R9400	0.15 (0.33)
220-240 V AC		1SVR550851R9400	0.15 (0.33)
24 V AC	CM-ENS	1SVR430851R9100	0.15 (0.33)
110-130 V AC		1SVR430851R0100	0.15 (0.33)
220-240 V AC		1SVR430851R1100	0.15 (0.33)
380-415 V AC		1SVR430851R2100	0.15 (0.33)
220-240 V AC ¹⁾		1SVR430851R1300	0.15 (0.33)
24 V AC	CM-ENS UP/DOWN	1SVR430851R9200	0.15 (0.33)
110-130 V AC		1SVR430851R0200	0.15 (0.33)
220-240 V AC		1SVR430851R1200	0.15 (0.33)
24-240 V AC/DC	CM-ENN	1SVR450055R0000	0.30 (0.66)
24 V AC		1SVR450059R0000	0.30 (0.66)
110-130 V AC		1SVR450050R0000	0.30 (0.66)
220-240 V AC		1SVR450051R0000	0.30 (0.66)
380-415 V AC	CM-ENN UP/DOWN	1SVR450052R0000	0.30 (0.66)
24 V AC		1SVR450059R0100	0.15 (0.33)
110-130 V AC		1SVR450050R0100	0.15 (0.33)
220-240 V AC	CM-ENN UP/DOWN	1SVR450051R0100	0.15 (0.33)
380-415 V AC		1SVR450052R0100	0.15 (0.33)



CM-ENE MIN



CM-ENE MAX



CM-ENS



CM-ENN

¹⁾ Version with protective separation acc. to VDE 0160, 1 n/o, 1 n/c

Liquid level monitors are

Suitable for		Not suitable for	
spring water	acids, bases	chemically pure water	ethylene glycol
drinking water	liquid fertilizers	fuel	concentrated alcohol
sea water	milk, beer, coffee	oils	paraffin
sewage	non-concentrated alcohol	explosive areas (liquid gas)	lacquers

Liquid level monitors and controls

Ordering details

Accessories

Compact support CM-KH-3 for 3 bar electrodes

Dimensions in mm

- Ideally suited for use with liquid level relays CM-ENS and CM-ENN
- Wire connection by screw terminals
- Pull relief by M16 screwed cable glands
- Temperature range up to 90 °C
- Food safe material (PPH)
- Screw-in electrodes (M4 thread)
- Distance plate (CM-AH-3) and locking nut (CM-GM-1) optionally available as an accessory

6

Compact support CM-KH-3

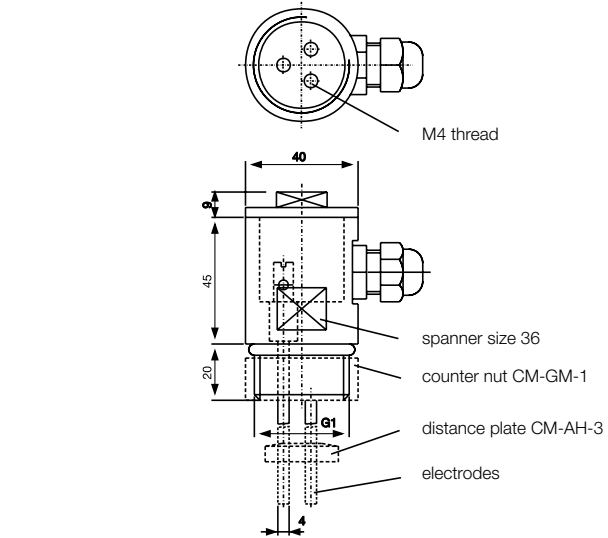
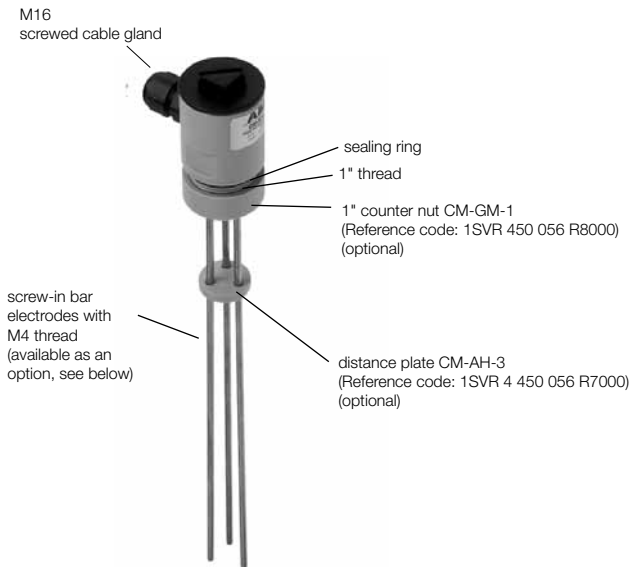

Distance plate CM-AH-3

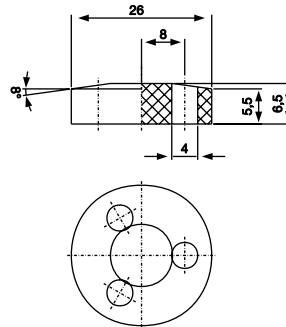

Counter nut CM-GM-1

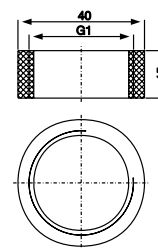

Technical data compact support

Type of mounting:	G 1" thread
Mounting position:	any
Enclosure material:	PPH
Sealing:	NBR 70
Temperature range:	90 °C max.
Pressure:	10 bar max. (60 °C)

Description	Reference code	Catalog number	Pkg qty	Weight (1 pce) kg (lb)
Compact support for 3 bar electrodes	CM-KH-3	1SVR450056R6000		0.06 (0.132)
Distance plate for 3 bar electrodes	CM-AH-3	1SVR450056R7000	1	0.06 (0.132)
Counter nut for 1" thread	CM-GM-1	1SVR450056R8000		0.06 (0.132)

Screw-in bar electrodes for compact support CM-KH-3

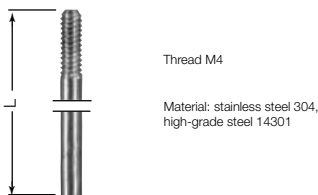

Suspension electrode CM-HE

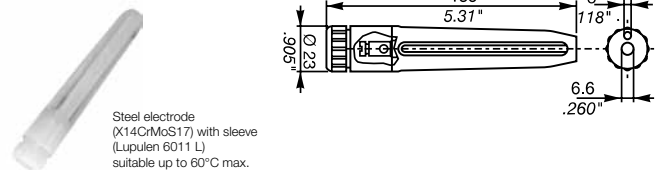

During project engineering the compatibility of the electrode material with the medium to be supervised is to be examined!

Length	Reference code	Catalog number	Pkg qty	Weight (1 pce) kg (lb)
300 mm	CM-SE-300	1SVR450056R0000		0.08 (0.176)
600 mm	CM-SE-600	1SVR450056R0100		0.08 (0.176)
1000 mm	CM-SE-1000	1SVR450056R0200		0.08 (0.176)
CM-HE	CM-HE	1SVR402902R0000	1	0.08 (0.176)

Liquid level monitors and controls

Function diagrams

Function diagram CM-ENS

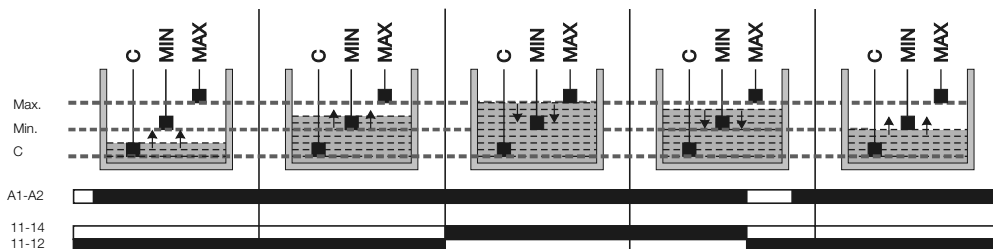

The CM-ENS monitors levels of conductive liquids and is used for example for liquid level control in pump systems. It can be used for filling or draining tanks for example. It is also suitable for monitoring the conductivity of liquids. The measuring principle is based on the resistance change sensed by single-pole electrodes. After the supply voltage is applied to the terminals A1 and A2, the output relay is de-energized. The probes must be connected to C, MAX, MIN. The output relay energizes if the liquid exceeds the maximum level (C and MAX wet) and de-energizes if the liquid level is below the minimum level (MAX and MIN dry). Based on the measuring circuit there will be a response delay of approx. 250 ms at maximum sensitivity. Different levels in one tank can be controlled by up to 5 CM-ENS without interfering with each other.

Function diagram CM-ENN UP/DOWN

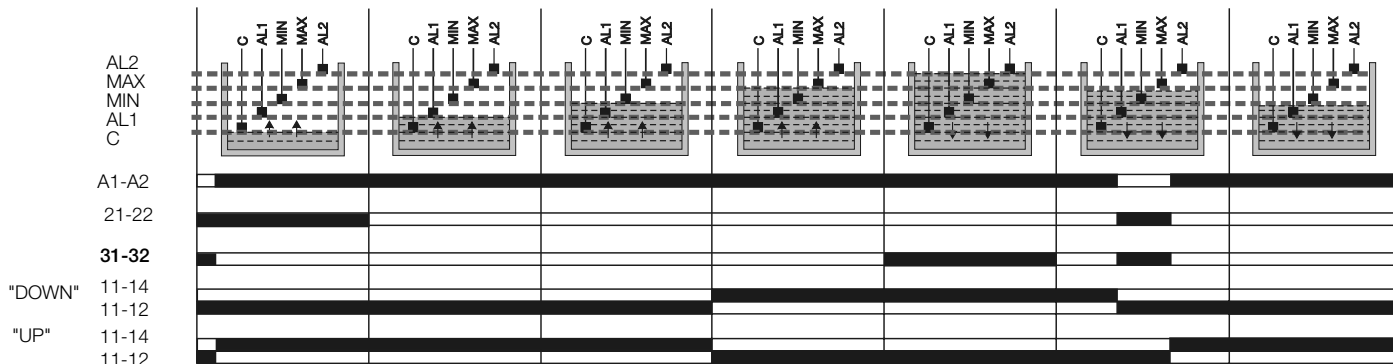

If a metal tank is used, the ground reference electrode C is not required. In this case the cable can be connected directly to the metal surface of the tank.

The CM-ENN UP/DOWN monitors levels of conductive liquids and media and is used e.g. for liquid level control in pump systems. The measuring principle is based on the resistance change sensed by single-pole electrodes. The function of the output relay 11-12/14 can be selected by a selector switch on the front of the unit to fill "UP" or drain "DOWN". If the "UP" function is selected, the output relay is energized until the MAX electrode becomes wet. Then it is de-energized and not re-energized until the MIN electrode becomes dry. If the "DOWN" function is selected, the output relay is energized as soon as the MAX electrode becomes wet. It remains energized until the liquid level has dropped below the MIN electrode. The electrode inputs AL1 and AL2 energize/de-energize the corresponding output relays RAL1 (21-22) and RAL2 (31-32). AL1 opens if contact RAL1 (21-22) is wet. AL2 closes if contact RAL2 (31-32) is wet. This way, two additional alarm outputs for exceeding or dropping below the normal level can be implemented in addition to the filling levels MAX and MIN.

Function diagram CM-ENS UP/DOWN

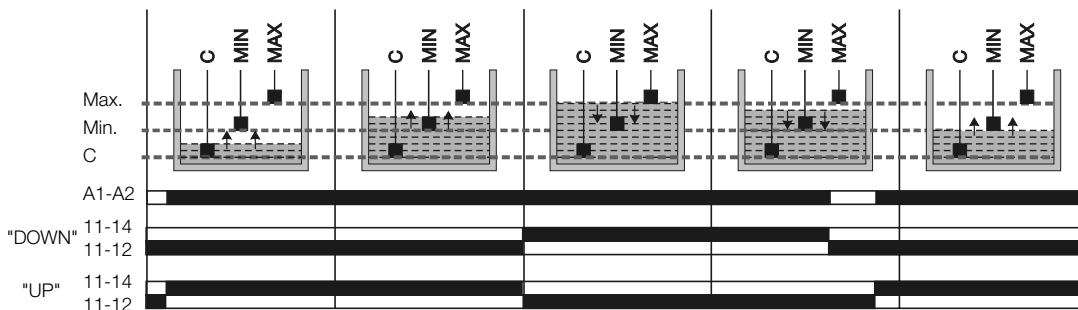

The CM-ENS UP/DOWN monitors levels of conductive liquids and other media, and is used e.g. for liquid level control in pump systems.

The measuring principle is based on the resistance change sensed by single-pole electrodes. The output relay functions fill (UP) or drain (DOWN) can be selected on a front-face selector switch. If the "UP" function is selected, the output relay is energized until the MAX electrode becomes wet. Then it is de-energized and not re-energized until the MIN electrode becomes dry. If the "DOWN" function is selected, the output relay is energized as soon as the MAX electrode becomes wet. It remains energized until the liquid level has dropped below the MIN electrode. The electrodes can be connected to more than one CM-ENS unit without interference.

Liquid level monitors and controls

Function diagrams

Function diagrams CM-ENN

Circuit with 2 electrodes

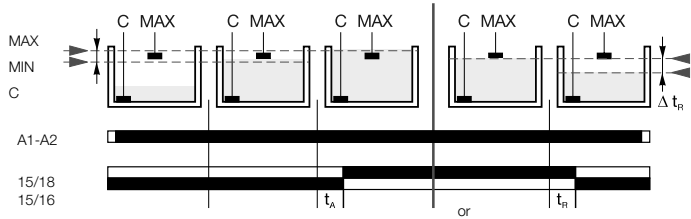

Circuit with 3 electrodes

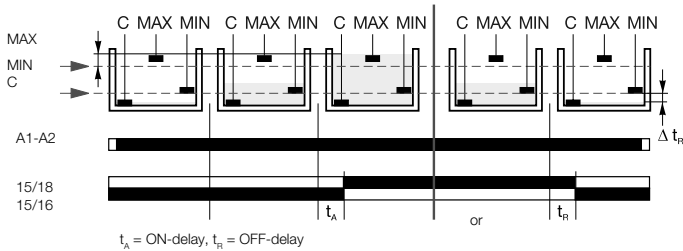

The CM-ENN monitors levels of conductive liquids and is used for example for liquid level monitoring in pump control systems, for dry-running protection of submersible pumps or overflow monitoring of tanks. It is also suitable for conductivity monitoring of liquids. The measuring principle is based on the resistance change sensed by single-pole electrodes (wet or dry).

Instead of electrodes, other sensors or transducers can also be used if their output quantities are different resistance values. The measuring, output and supply circuits are electrically isolated for potential separation and to prevent electrical interference.

Due to the integrated ON- or OFF-delay, it is possible to set up time-dependent liquid controls using only two electrodes (C, MAX). Different liquid levels in one tank can be controlled by up to 5 CM-ENN (AC version) without mutual interference.

Function diagram CM-ENE MIN

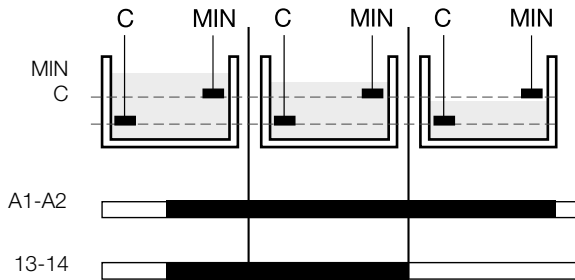

Function diagram CM-ENE MAX

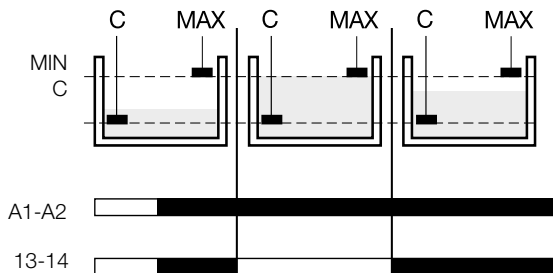

The liquid level relays CM-ENE MIN and CM-ENE MAX are used to monitor levels of conductive liquids, for example in pump control systems for dry-running or overflow monitoring.

The measuring principle is based on the occurring resistance change when moistening single-pole electrodes. The single-pole electrodes (see also section Accessories) are connected to the terminals C and MIN or MAX. If the supply voltage is applied to A1-A2 and the electrodes are wet, the output relay of the CM-ENE MIN is energized and the output relay of the CM-ENE MAX is de-energized.

The output relay of the CM-ENE MIN de-energizes if the electrodes are no longer wet. The output relay of the CM-ENE MAX energizes if the electrodes are no longer wet.

Liquid level monitors and controls

Connection diagrams

Connection diagram CM-ENE MIN

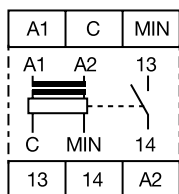

- A1-A2 Rated control supply voltage
- C Ground reference electrode
- MIN Minimum level
- 13-14 Output contact - open-circuit principle

Connection diagram CM-ENE MAX

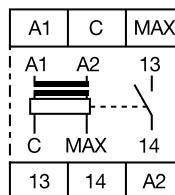

- A1-A2 Rated control supply voltage
- C Ground reference electrode
- MAX Max. level
- 13-14 Output contact - closed-circuit principle

Connection diagram CM-ENS

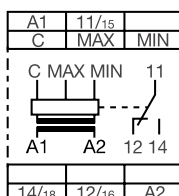

- A1-A2 Rated control supply voltage
- C Ground reference electrode
- MAX Maximum level
- MIN Minimum level
- 11(15)-12(16)/14(18) Output contacts - open-circuit principle

Connection diagram CM-ENN

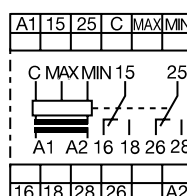

- A1-A2 Rated control supply voltage
- C Ground reference electrode
- MIN Min. level electrode
- MAX Max. level electrode
- 15-16/18 Output contacts - 25-26/28 open-circuit principle

Connection diagram CM-ENS UP/DOWN

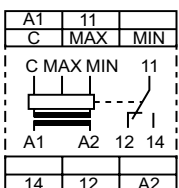

- A1 - A2 Rated control supply voltage
- C Ground reference electrode
- MAX Maximum level
- MIN Minimum level
- 11-12/14 Output contacts - open-circuit or closed-circuit principle selectable

Connection diagram CM-ENN UP/DOWN

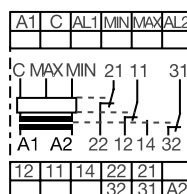

- A1-A2 Rated control supply voltage
- C Ground reference electrode
- MIN Minimum level electrode
- MAX Maximum level electrode
- AL1 Alarm electrode 1
- AL2 Alarm electrode 2
- 11-12/14 Output contacts - open-circuit or closed-circuit principle selectable

Liquid level monitors and controls

Application examples

6

Application examples CM-ENE MIN/MAX

CM-ENE MIN

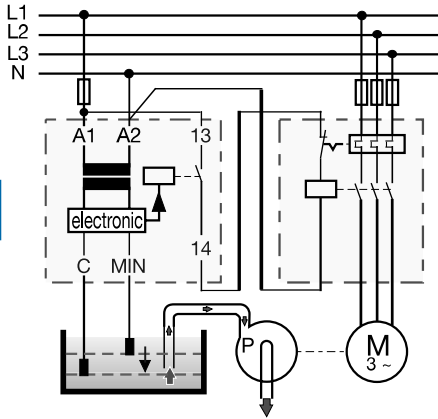

CM-ENE MAX

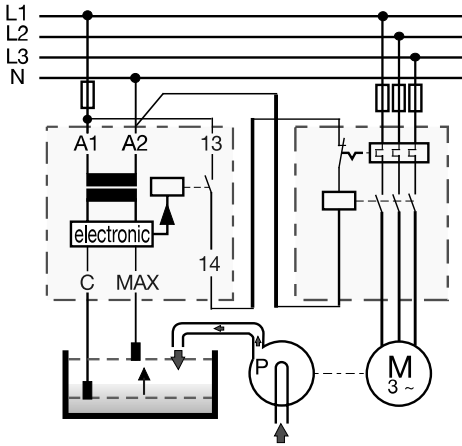

CM-ENE MIN und CM-ENE MAX

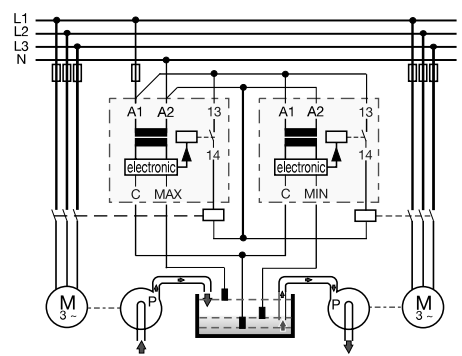

Application examples CM-ENS

fill

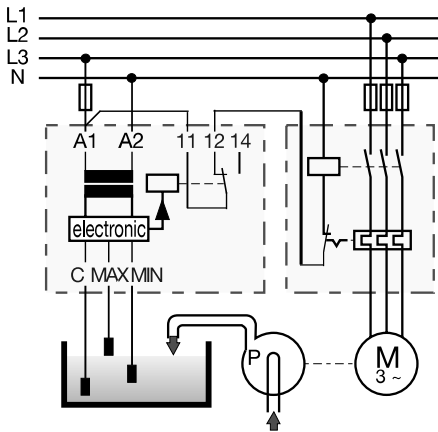

drain

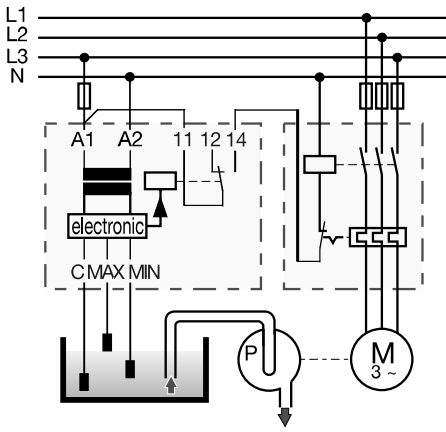

Cascading
The electrode inputs can be interconnected as required, which ensures simple monitoring of different liquid levels.

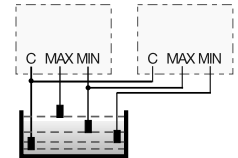

Redundancy
Redundant liquid level monitoring or control can be implemented by connecting the electrodes to two units. This makes the application much safer.

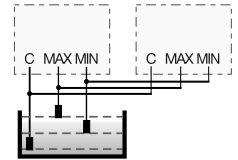

Cascading of electrodes
The electrode inputs can be interconnected as required, which ensures simple monitoring of different liquid levels.

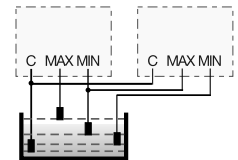

Redundancy
Redundant liquid level monitoring or control can be implemented by connecting the electrodes to two units. This makes the application much safer.

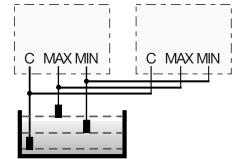

Application examples CM-ENS UP/DOWN

Liquid level control - fill - switch position "UP"

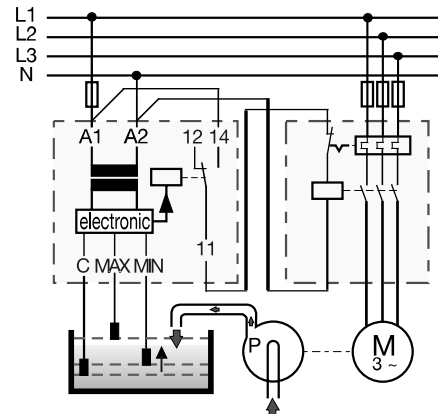

Liquid level control - drain - switch position "DOWN"

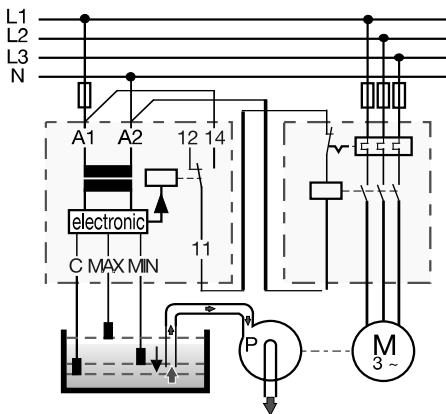

Liquid level monitors and controls

Application examples

Application examples CM-ENN

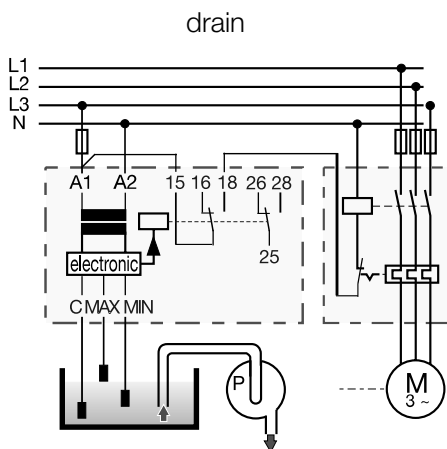
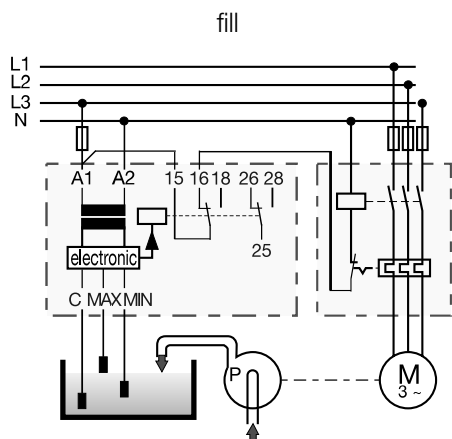

For commissioning, set both potentiometers (response sensitivity = R value and ON-delay = time value) to the minimum value (5) and select a suitable resistance range (sector).

After all electrodes have been wetted by the liquid being monitored, turn the sensitivity potentiometer towards maximum value (100) until the relay energizes. If the relay does not energize, select a higher Ω value (sector) on the device and proceed as before.

Then it has to be checked if the relay de-energizes properly as soon as the electrodes C and MIN are no longer wet. Liquid levels higher than the maximum level electrode can be obtained by setting an ON-delay (TA = 0.1...10 s).

Liquid levels lower than the minimum level electrode can be obtained by setting an OFF-delay time (TR = 0.1...10 s), e.g. for emptying tanks.

6

Application example CM-ENN UP/DOWN

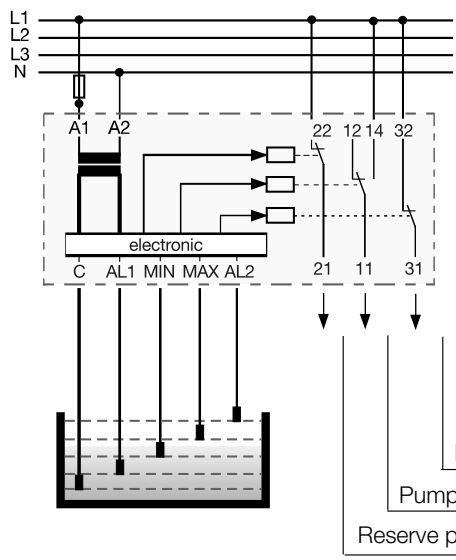

Electrode	Relay	LED
AL1 not wet	RAL1 (21-22) closed	off
AL1 wet	RAL1 (21-22) open	on
AL2 wet	RAL2 (31-32) closed	off
AL2 not wet	RAL2 (31-32) open	on
Supply voltage failure	RAL1 (21-22) RAL2 (31-32)	closed off

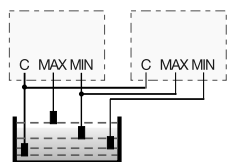

Cascading of electrodes
The electrode inputs can be interconnected as required, which ensures simple monitoring of different liquid levels.

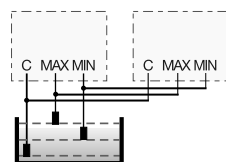

Redundancy
Redundant liquid level monitoring or control can be implemented by connecting the electrodes to two units.

This makes the application much safer.

Liquid level monitors and controls

Technical data

6

Type		CM-ENE MIN	CM-ENE MAX
Supply circuit			
Rated control supply voltage U_s - power consumption	A1-A2	24 V AC	approx. 1.5 VA
	A1-A2	110-130 V AC	approx. 1.2 VA
	A1-A2	220-240 V AC	approx. 1.4 VA
Rated control supply voltage U_s tolerance			-15...+15 %
Rated frequency			50-60 Hz
Duty time			100 %
Measuring circuit			
Monitoring function		dry-running protection	overflow protection
Response sensitivity		0-100 k Ω , not adjustable	
Maximum electrode voltage		30 V AC	
Maximum electrode current		1.5 mA	
Electrode supply line	max. cable capacity	3 nF	
	max. cable length	30 m	
Timing circuit			
Time delay		-	
Tripping delay		fixed approx. 200 ms	
Indication of operational states			
Output relay energized		R: yellow LED	
Output circuits			
Kind of output		13-14	
Operational principle 1)		1 n/o contact	
Contact material		open-circuit principle	closed-circuit principle
Rated operational voltage U_s (IEC/EN 60947-1)		AgCdo	
Minimum switching voltage / minimum switching current		250 V	
Maximum switching voltage		- / -	
Rated operational current I_s (IEC/EN 60947-5-1)		250 V	
AC rating (UL 508)	Utilization category (Control Circuit Rating Code)	4 A	
	max. rated operational voltage	3 A	
	max. continuous thermal current at B 300	4 A	
	max. making/breaking apparent power at B 300	2 A	
Mechanical lifetime		B 300	
Electrical lifetime (AC12, 230 V, 4 A)		300 V AC	
Max. fuse rating to achieve short-circuit protection	n/c contact	5 A	
	n/o contact	3600/360 VA	
		30 x 10 ⁶ switching cycles	
		0.3 x 10 ⁶ switching cycles	
		-	
		10 A fast-acting	
General data			
Dimensions (W x H x D)		22.5 x 78 x 78.5 mm (0.89 x 3.07 x 3.09 in)	
Mounting position		any	
Degree of protection	enclosure / terminals	IP50 / IP20	
Ambient temperature range	operation / storage	-20...+60 °C / -40...+85 °C	
Mounting		DIN rail (IEC/EN 60715)	
Electrical connection			
Wire size	fine-strand with wire-end ferrule	2 x 0.75-1.5 mm ² (2 x 18-16 AWG)	
	fine-strand without wire-end ferrule	2 x 1-1.5 mm ² (2 x 18-16 AWG)	
	rigid	2 x 0.75-1.5 mm ² (2 x 18-16 AWG)	
Stripping length		10 mm (0.39 inch)	
Tightening torque		0.6-0.8 Nm	
Standards			
Product standard		IEC 255-6, EN 60255-6	
Low Voltage Directive		2006/95/EC	
EMC Directive		2004/108/EC	
Electromagnetic compatibility			
electrostatic discharge	IEC/EN 61000-4-2	EN 61000-6-2, EN 61000-6-4	
radiated, radio-frequency, electromagnetic field	IEC/EN 61000-4-3	Level 3 (6 kV / 8 kV)	
electrical fast transient / burst	IEC/EN 61000-4-4	Level 3 (10 V/m)	
surge	IEC/EN 61000-4-5	Level 3 (2 kV / 5 kHz)	
conducted disturbances, induced by radio-frequency fields	IEC/EN 61000-4-6	Level 4 (2 kV L-L)	
Resistance to vibration (IEC 68-2-6)		Level 3 (10 V)	
Mechanical resistance (IEC 68-2-6)		6 g	
		10 g	
Isolation data			
Rat. insulation volt. betw. supply, meas. & output circuit (VDE 0110, IEC 60947)		250 V	
Rated impulse withstand voltage between all isolated circuits (VDE 0110, IEC 664)		4 kV / 1.2-50 μ s	
Test voltage between all isolated circuits		2.5 kV, 50 Hz, 1 min.	
Pollution category (VDE 0110, IEC 664, IEC 255-5)		3 / C	
Overvoltage category (VDE 0110, IEC 664, IEC 255-5)		III / C	
Environmental testing (IEC 68-2-30)		24 h cycle time, 55 °C, 93 % rel., 96 h	

1) Open-circuit principle: Output relay energizes if the measured value exceeds/drops below the adjusted threshold.
 Closed-circuit principle: Output relay de-energizes if the measured value exceeds/drops below the adjusted threshold.

Liquid level monitors and controls

Technical data

Measuring &
monitoring relays
CM Range

6

Type		CM-ENS	CM ENS UP/DOWN
Supply circuit			
Rated control supply voltage U_s - power consumption	A1-A2	24 V AC	24 V AC
	A1-A2	110-130 V AC approx. 1.5 VA	110-130 V AC approx. 4 VA
	A1-A2	220-240 V AC approx. 1.5 VA	220-240 V AC approx. 4 VA
	A1-A2	380-415 V AC approx. 1.5 VA	
Rated control supply voltage U_s tolerance			-15...+10 %
Rated frequency			50-60 Hz
Duty time			100 %
Measuring circuit			
Monitoring function			MAX-MIN-C
Response sensitivity			liquid level control
Maximum electrode voltage			5-100 kg, adjustable
Maximum electrode current			30 V AC
Electrode supply line	max. cable capacity		1 mA
	max. cable length		10 nF
			100 m
Timing circuit			
Time delay			-
Tripping delay			approx. 250 ms
Indication of operational states			
Control supply voltage			U: green LED
Output relay energized			R MAX/MIN: yellow LED
Alarm relay AL1			R AL1: yellow LED
Alarm relay AL2			R AL2: yellow LED
Output circuits			
Kind of output			11-12/14, 21-22, 31-32
Operational principle ¹⁾			1 c/o contact, 1 n/o + 1 n/c contact 2)
Contact material			open-circuit principle
Rated operational voltage U_o (IEC/EN 60947-1)			open- and closed-circuit principle
Minimum switching voltage / minimum switching current			AgCdo
Maximum switching voltage			250 V
Rated operational current I_o (IEC/EN 60947-5-1)			- / -
	AC12 (resistive) 230 V		250 V
	AC15 (inductive) 230 V		4 A
	DC12 (resistive) 24 V		3 A
	DC13 (inductive) 24 V		4 A
			2 A
AC rating (UL 508)	Utilization category (Control Circuit Rating Code)		B 300
	max. rated operational voltage		300 V AC
	max. continuous thermal current at B 300		5 A
	max. making/breaking apparent power at B 300		3600/360 VA
Mechanical lifetime			30 x 106 switching cycles
Electrical lifetime (AC12, 230 V, 4 A)			0.3 x 106 switching cycles
Max. fuse rating to achieve short-circuit protection	n/c / n/o contact		10 A fast-acting / 10 A fast-acting
General data			
Dimensions (W x H x D)			22.5 x 70 x 100 mm (0.89 x 3.07 x 3.94 in)
Mounting position			any
Degree of protection	enclosure / terminals		IP50 / IP20
Ambient temperature range	operation / storage		-20...+60 °C / -40...+85 °C
Mounting			DIN rail (IEC/EN 60715)
Electrical connection			
Wire size	fine-strand with wire end ferrule		2 x 2.5 mm ² (2 x 14 AWG)
Standards			
Product standard			IEC 255-6, EN 60255-6
Low Voltage Directive			2006/95/EG
EMC Directive			2004/108/EG
Electromagnetic compatibility			
electrostatic discharge	IEC/EN 61000-4-2		Level 3 (6 kV / 8kV)
radiated, radio-frequency, electromagnetic field	IEC/EN 61000-4-3		Level 3 (10 V/m)
electrical fast transient / burst	IEC/EN 61000-4-4		Level 3 (2 kV / 5 kHz)
surge	IEC/EN 61000-4-5		Level 4 (2 kV L-L)
conducted disturbances, induced by radio-frequency fields	IEC/EN 61000-4-6		Level 3 (10 V)
Resistance to vibration (IEC 68-2-6)			4 g
Mechanical resistance (IEC 68-2-6)			6 g
Isolation data			
Rated insulation voltage between supply, measuring and output circuit (VDE 0110, IEC 60947)			250 V
Rated impulse withstand voltage between all isolated circuits (VDE 0110, IEC 664)			4 kV / 1.2 - 50 μ s
Test voltage between all isolated circuits			2.5 kV, 50 Hz, 1 min.
Pollution category (VDE 0110, IEC 664, IEC 255-5)			3 / C
Overvoltage category (VDE 0110, IEC 664, IEC 255-5)			III / C
Environmental testing (IEC 68-2-30)			24 h cycle time, 55 °C, 93 % rel., 96 h

¹⁾ Open-circuit principle: Output relay energizes if the measured value exceeds/drops below the adjusted threshold.
 Closed-circuit principle: Output relay de-energizes if the measured value exceeds/drops below the adjusted threshold.

²⁾ 1SVR 430 851 R1300 (version with safe isolation)

Liquid level monitors and controls

Technical data

6

Type		CM-ENN UP/DOWN		CM-ENN
Supply circuit				
Rated control supply voltage U_s - power consumption	A1-A2	24 V AC		24 V AC
	A1-A2	110-130 V AC approx. 1.5 VA		110-130 V AC approx. 2.5 VA
	A1-A2	220-240 V AC approx. 1.5 VA		220-240 V AC approx. 3 VA
	A1-A2	380-415 V AC approx. 1.5 VA		380-415 V AC approx. 4 VA
	A1-A2			24-240 V AC/DC approx. 2 VA/W
Rated control supply voltage U_s tolerance				-15...+10 %
Rated frequency		50-60 Hz		50-60 Hz oder DC
Duty time				100 %
Measuring circuit				
Monitoring function		MAX-MIN-C liquid level control		
Response sensitivity		adjustable 5-100 k Ω	adjustable 250 Ω - 5 k Ω	adjustable 2.5-50 k Ω 25-500 k Ω
Maximum electrode voltage		30 V AC		20 V AC
Maximum electrode current		1 mA	8 mA	2 mA 0.5 mA
Electrode supply line	max. cable capacity	10 nF	200 nF	20 nF 4 nF
	max. cable length	100 m	1000 m	100 m 20 m
Timing circuit				
Time delay		-		0.1-10 s, adjustable, ON- or OFF-delay
Tripping delay		approx. 250 ms		-
Indication of operational states				
Control supply voltage		U: green LED		
Output relay energized		R MAX/MIN: yellow LED		R: yellow LED
Output circuits				
Kind of output		11-12/14, 21-22, 31-32		15-16/18, 25-26/28
Operational principle ¹⁾		1 c/o + 2 n/c contacts		2 c/o contacts
Contact material		open-circuit principle		open- and closed-circuit principle
Rated operational voltage U_e	IEC/EN 60947-1	250 V		400 V
Minimum switching voltage / minimum switching current		- / -		- / -
Maximum switching voltage		250 V		400 V
Rated operational current I_e (IEC/EN 60947-5-1)	AC12 (resistive) 230 V	4 A		5 A
	AC15 (inductive) 230 V		3 A	
	DC12 (resistive) 24 V	4 A		5 A
	DC13 (inductive) 24 V	2 A		2.5 A
AC rating (UL 508)	Utilization category (Control Circuit Rating Code)			B 300
	max. rated operational voltage			300 V AC
	max. continuous thermal current at B 300			5 A
	max. making/breaking apparent power at B 300			3600/360 VA
Mechanical lifetime				30 x 10 ⁵ switching cycles
Electrical lifetime (AC12, 230 V, 4 A)				0.3 x 10 ⁶ switching cycles 0.1 x 10 ⁶ switching cycles
Max. fuse rating to achieve short-circuit protection	n/c / n/o contact			4 A fast-acting / 6 A fast-acting
General data				
Dimensions (W X H X D)		45 x 78 x 100 mm (1.77 x 3.07 x 3.94 in)		
Mounting position		any		
Degree of protection	enclosure / terminals	IP50 / IP20		
Ambient temperature range	operation / storage	-25...+65 °C / -40...+85 °C		
Mounting		DIN rail (IEC/EN 60715)		
Electrical connection				
Wire size	fine-strand with wire end ferrule	2 x 2.5 mm ² (2 x 14 AWG)		
Standards				
Product standard		IEC 255-6, EN 60255-6		
Low Voltage Directive		2006/95/EG		
EMC Directive		2004/108/EG		
Electromagnetic compatibility				
electrostatic discharge	IEC/EN 61000-4-2	Level 3 (6 kV / 8kV)		
radiated, radio-frequency, electromagnetic field	IEC/EN 61000-4-3	Level 3 (10 V/m)		
electrical fast transient / burst	IEC/EN 61000-4-4	Level 3 (2 kV / 5 kHz)		
surge	IEC/EN 61000-4-5	Level 4 (2 kV L-L)		
conducted disturbances, induced by radio-frequency fields	IEC/EN 61000-4-6	Level 3 (10 V)		
Resistance to vibration (IEC 68-2-6)		5 g		
Mechanical resistance (IEC 68-2-6)		10 g		
Isolation data				
Rated insulation voltage between supply, measuring and output circuit (VDE 0110, IEC 60947)		250 V		500 V
Rated impulse withstand voltage between all isolated circuits (VDE 0110, IEC 664)				4 kV / 1.2 - 50 μ s
Test voltage between all isolated circuits				2.5 kV, 50 Hz, 1 min.
Pollution category (VDE 0110, IEC 664, IEC 255-5)				3 / C
Overvoltage category (VDE 0110, IEC 664, IEC 255-5)				III / C
Environmental testing (IEC 68-2-30)		24 h cycle time, 55 °C, 93 % rel., 96 h		

¹⁾ Open-circuit principle: Output relay energizes if the measured value exceeds/drops below the adjusted threshold.
Closed-circuit principle: Output relay de-energizes if the measured value exceeds/drops below the adjusted threshold.

Contact protection & sensor interface relays



Contact protection & sensor interface relays



Contact protection and sensor interface relays

Ordering details

Description

Contact protection relay:

The CM-KRN protects sensitive control contacts from excessive load. It can be used with latching function or without. Bounce time of control contacts can be bypassed by the adjustable response delay time. Use for contact protection.

Contact protection relay:

The CM-SIS is used to supply 2- or 3-wire NPN or PNP sensors with power and to evaluate their switching signals. Two sensors of the types NPN or PNP can be connected simultaneously. Selection is done via the front-face rotary switch.



CM-KRN



CM-SIS

Ordering details

Rated control supply voltage	Timing circuit	Reference code	Catalog number	Weight (1 pce) kg (lb)
24 V AC	0.05-30 s	CM-KRN	1SVR450089R0000	0.30 (0.66)
110-130 V AC			1SVR450080R0000	0.30 (0.66)
220-240 V AC			1SVR450081R0000	0.30 (0.66)
380-415 V AC			1SVR450082R0000	0.30 (0.66)
24 V AC			1SVR450099R0000	0.30 (0.66)
110-130 V AC			1SVR450090R0000	0.30 (0.66)
220-240 V AC			1SVR450091R0000	0.30 (0.66)
24 V AC/DC ¹⁾			1SVR450099R1000	0.30 (0.66)
110-240 V AC / 105-260 V DC ²⁾		CM-SIS	1SVR430500R2300	0.22 (0.48)

¹⁾ Not electrically isolated

²⁾ Safe isolation, short circuit and overload proof

Characteristics CM-KRN

- Protects and reduces load from sensitive control contacts
- Adjustable ON-delay 0.05-30 s
- Acts as two-position switch
- Stores switch positions
- Electrically isolated circuits
- 2 c/o contacts
- 2 LEDs for status indication

Characteristics CM-SIS

- High efficiency
- Low heating
- Wide range of supply voltage
- Constant output voltage 24 V DC
- Safe isolation acc. to EN 50178 (VDE 0160)
- Short-circuit and overload proof
- Input protected by internal fuse
- 2 x 1 c/o contact
- 3 LEDs for status indication

Contact protection and sensor interface relays

Technical information

Use for contact protection. The contact to be protected is connected to terminals Y1 and Y2. Use for contact protection with latching capacity. The output relay energizes after contact Y1-Y3 has been closed for at least 20 ms. It remains energized until contact Y1-Y4 closes. The switching positions are stored. The relay is suitable for load reduction purposes for devices with minimum and maximum contacts. The CM-KRN can be operated via 3-wire proximity sensors for switching of higher power. The supply circuit, the control circuit and the output circuit are electrically isolated against each other.

Function diagram CM-KRN

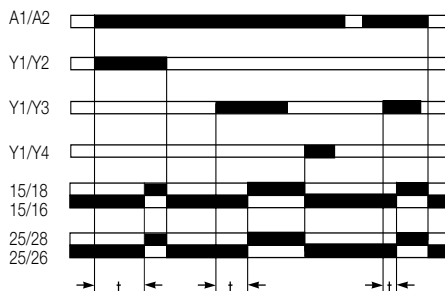

Connection diagram CM-KRN

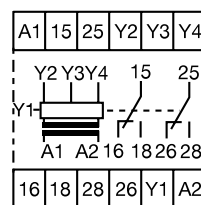

- A1-A2 Rated control supply voltage
- Measuring circuits:
 - Y1-Y2 "On-Off" input (max. switch-on resistance 6-10 kΩ, min. switch-off resistance 15-20 kΩ)
 - Y1-Y3 "Set" input (max. switch-on resistance 6-10 kΩ)
 - Y1-Y4 "Reset" input (max. switch-off resistance 15-20 kΩ)
- 15-16/18 Output contacts - open-circuit principle
- 25-26/28 Output contacts - open-circuit principle

Use, applications

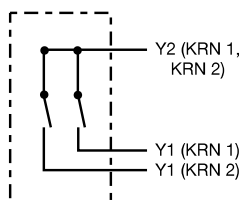

Actuators with 2 contacts and one common point can be connected to 2 separate CM-KRN units. Connect the common point of contacts to terminals Y2 of the two CM-KRN units.

Operation via 3-wire proximity sensors NPN

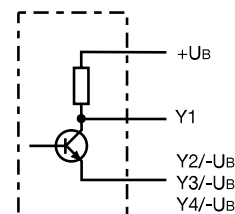

On; relay energizes, Y1/Y3 or Y2
Off; relay de-energizes, Y1/Y4 or Y2

The CM-SIS (terminals L+, L-) supplies the connected sensors with voltage (24 V DC), the maximum power supply current is 0.5 A. The supply voltage and the sensor inputs are electrically isolated from the supply circuit. To ensure maximum safety when using these sensors, the principle of safe isolation has been included.

Function diagram CM-SIS

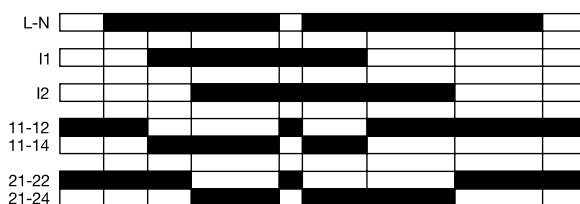

Connection diagram CM-SIS

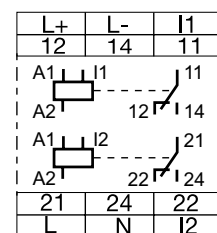

- L - N Rated control supply voltage
- I1 Sensor input 1
- I2 Sensor input 2
- L+ - L- Output voltage 24 V DC / 0.5 A
- 11-12/14 Output contacts - open-circuit principle
- 21-22/24 Output contacts - open-circuit principle

Each sensor input signal energizes the corresponding output relay without delay. The relay is energized as soon as a threshold current is exceeded at input I1 or I2. Sensor leakage currents of up to 8 mA don't affect the evaluation. The threshold value is about 9 mA. If the threshold value at input I1 or I2 is exceeded the corresponding relay R1 or R2 energizes and the corresponding LED lights up.

Connection of 2-wire sensors

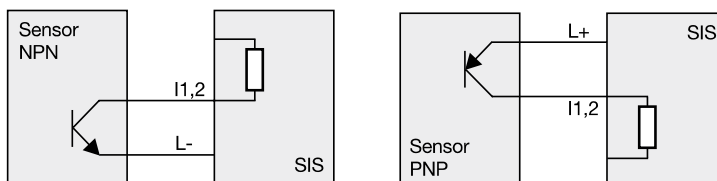

The wide-range supply voltage input of CM-SIS allows its application in nearly all supply systems.

Connection of 3-wire sensors

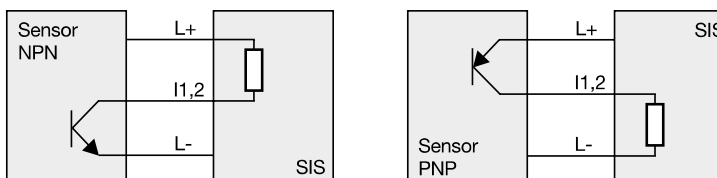



The CM-SIS is also suitable for other applications, for example it is also possible to connect PTC or NTC resistors instead of PNP or NPN sensors or to operate the SIS directly by switching contacts.

Contact protection and sensor interface relays

Technical data

6

Type		CM-KRN
Supply circuit		A1-A2
Rated control supply voltage U_s - power consumption	A1-A2	24 V AC - approx. 3.5 VA
	A1-A2	24 V AC/DC - approx. 3.5 VA
	A1-A2	110-130 V AC - approx. 3.5 VA
	A1-A2	220-240 V AC - approx. 3.5 VA
	A1-A2	380-415 V AC - approx. 3.5 VA
Rated control supply voltage U_s tolerance		-15...+10 %
Rated frequency		50-60 Hz
Duty time		100 %
Timing circuit		
ON-delay time		0.05-1 s, 1.5-30 s
OFF-delay time		max. 50 ms
Measuring circuit / contact circuit		Y1-Y2/Y3/Y4
Measuring input	contact protection without latching	Y1-Y2
	contact protection with latching	Y1-Y3/Y4
Threshold	Y1-Y2/Y3	6-10 k Ω
Threshold-Hysteresis	Y1-Y2/Y4	15-20 k Ω
No-load voltage at the measuring input		\leq 10 V DC
Contact time for latching (CM-KRN without timing circuit)		min. 20 ms
Switching current at the measuring input		3 mA
Maximum applied voltage at the measuring input		\leq \pm 30 V (contact voltage)
Indication of operational states		
Control supply voltage	U: green LED	 : control supply voltage applied
Relay status	R: yellow LED	 : output relay energized
Output circuit		15-16/18, 25-26/28
Kind of output		relay, 2 c/o contacts
Operating principle ¹⁾		open-circuit principle
Rated operational voltage (VDE 0110, IEC 60947-5-1)		400 V
Rated switching voltage		400 V AC
Rated operational current I_n (IEC/EN 60947-5-1)	AC12 (resistive) 230 V	5 A
	AC15 (inductive) 230 V	3 A
	DC12 (resistive) 24 V	5 A
	DC13 (inductive) 24 V	2.5 A
AC rating (UL 508)	Utilization category (Control Circuit Rating Code)	B 300
	max. rated operational voltage	300 V AC
	max. continuous thermal current at B 300	5 A
	max. making/breaking apparent power at B 300	3600/360 VA
Mechanical lifetime		30 x 10 ⁶ switching cycles
Electrical lifetime (AC12, 230 V, 5 A)		0.1 x 10 ⁶ switching cycles
Max. fuse rating to achieve short-circuit protection	n/c / n/o contact	10 A fast-acting / 10 A fast-acting
General data		
Dimensions (W x H x D)		45 x 78 x 100 mm (1.77 x 3.07 x 3.94 in)
Mounting position		any
Degree of protection	enclosure / terminals	IP20 / IP50
Ambient temperature range	operation / storage	-25...+65 °C / -40...+85 °C
Mounting		DIN rail (IEC/EN 60715)
Electrical connection		
Wire size	fine-strand with wire end ferrule	2 x 2.5 mm ² (2 x 14 AWG)
Standards		
Product standard		IEC 255-6, EN 60255-6
Low Voltage Directive		2006/95/EC
EMC Directive		2004/108/EC
Electromagnetic compatibility		
Interference immunity to		
electrostatic discharge	IEC/EN 61000-4-2	6 kV / 8 kV
radiated, radio-frequency, electromagnetic field	IEC/EN 61000-4-3	10 V/m
electrical fast transient / burst	IEC/EN 61000-4-4	2 kV / 5 kHz
surge	IEC/EN 61000-4-5	2 kV symmetrical
conducted disturbances, induced by radio-frequency fields	IEC/EN 61000-4-6	10 V
Isolation data		
Rated insulation voltage (IEC 60947-1)		400 V
Rated impulse withstand voltage U_{imp} (IEC 644-6)		4 kV
Pollution category (IEC 255-5, IEC 664)		3
Overvoltage category (IEC 255-5, IEC 664)		III

¹⁾ Open-circuit principle: Output relay is energized if the measured value exceeds/drops below the adjusted threshold.

Contact protection and sensor interface relays

Technical information

Measuring & monitoring relays
CM Range

6

Type		CM-SIS
Input circuit		
Supply voltage	L-N AC DC	110-240 V AC (-15...+10 %) 110-240 V (max. 105-260 V DC)
Frequency, AC supply		47-440 Hz
Supply voltage failure bridging time		10 ms min. at 100 % load
Current consumption	max. at 115 V AC at 230 V AC	0.35 A 0.27 A 0.14 A
Inrush current at 25°C (≤ 2 ms)		33 A
Internal input fuse		800 mA slow-acting
Measuring circuit		
Sensor voltage	L+ L-	24 V DC ± 3%
Sensor current / power		max. 0.5 A / 12 W
Residual ripple		max. 100 mV _{pp}
Deviation with	load change statical load change dynamical 10-90 % change of the input voltage	max. ± 0.5 % max. .5 % max. ± 0.5 %
Short-circuit protection		overcurrent switch-off with automatic restart
Overload protection		excess temperature and overcurrent switch-off
Reset after thermal overload switch-off		automatic reset after cooling down
Sensor type connection possibilities	I1, I2	2- or 3-wire connection, NPN or PNP selectable by front-face switch
Input resistance		approx. 2.5 kΩ
Threshold value for relays R1, R2		$U_{emitter/collector} < 2.3 \text{ V (I1, I2 > 8 mA)}$
Maximum switching frequency		approx. 20 Hz
Output circuit		
Kind of output		11-12/14, 21-22/24 2 relays, 1 c/o contact each
Operating principle ¹⁾		open-circuit principle
Rated operational voltage		250 V
Maximum switching voltage		250 V AC
Rated operational current I _n (IEC/EN 60947-5-1)	AC12 (resistive) 230 V AC15 (inductive) 230 V DC12 (resistive) 24 V DC13 (inductive) 24 V	4 A 3 A 4 A 2 A
AC rating (UL 508)	Utilization category (Control Circuit Rating Code) max. rated operational voltage max. continuous thermal current at B 300 max. making/breaking apparent power at B 300	B 300 300 V AC 5 A 3600/360 VA
Mechanical lifetime		10 x 10 ⁶ switching cycles
Electrical lifetime		0.1 x 10 ⁶ switching cycles
Max. fuse rating to achieve short-circuit protection	n/c / n/o contact	6 A fast-acting / 10 A fast-acting
Indication of operational states		
Control supply voltage	U: green LED	: control supply voltage applied
Relay status R1	R1: yellow LED	: threshold value at input I1 exceeded
Relay status R2	R2: yellow LED	: threshold value at input I2 exceeded
General data		
Efficiency at rated load		approx. 84 % (at 230 V AC)
Ambient temperature range	operation / storage	0...+55 °C / -25...+75 °C
Dimensions (W x H x D)		22.5 x 78 x 100 mm (0.89 x 3.07 x 3.94 in)
Mounting position		horizontally
Mounting		DIN rail (IEC/EN 60715)
Minimum distance to other units		left-hand side 10 mm (0.39 in), vertical distance 50 mm (1.97 in)
Electrical connection		
Wire size		2 x 2,5 mm ² (2 x 14 AWG)
Standards		
Product standard		IEC 255-6, EN 60255-6
Electrical safety		IEC(EN) 60255-5, EN 50178 (VDE 0160), EN60950, UL 508, CSA 22.2
Galvanic isolation		safe isolation between L+,L-, I1,I2, and L,N,11,12,14,21,22,24
Electromagnetic compatibility		
Interference immunity to		EN 61000-6-2
electrostatic discharge	IEC/EN 61000-4-2	Level 3 (6 / 8 kV)
radiated, radio-frequency, electromagnetic field	IEC/EN 61000-4-3	Level 3 (10 V/m)
electrical fast transient / burst	IEC/EN 61000-4-4	Level 4 (4 kV)
surge	IEC/EN 61000-4-5	Inst. class 3 (2 kV)
conducted disturbances, induced by radio-frequency fields	IEC/EN 61000-4-6	Level 3 (10 V)
Interference immunity to	EN 50081-2	radiated noise EN 55011, class B
Input current harmonics		no limitation
Isolation data		
Insulation testing		2.5 kV AC (routine test), 3 kV AC (type test)
Degree of pollution		2
Overvoltage category		II

Notes

Cycle monitoring relay w/watchdog function



Cycle monitoring relay
with watchdog function



Cycle monitoring relay with watchdog function

Ordering details

Description

The cycle monitoring relay CM-WDS (watchdog) observes if a regularly intermittent pulse is applied to its pulse input "I". It is, for example, possible to connect the output of a programmable logic controller (plc), which is set and reset regularly (e. g. once each cycle). The connected cycle pulse must be generated by suitable programming of the plc/ipc. Now, the CM-WDS monitors if the cycle time of the plc/ipc program is smaller than the cycle monitoring time set by means of the front-face selector switch "time value (ms)".

The output relay 11-12/14 of the CM-WDS energizes and the red LED is switched off, if there are minimum 8 successive regular pulses on input "I". When the pulse signal stays out or is not regular, the output relay de-energizes and the red LED is illuminated.

In case the monitoring time is too short or too long, this can be adjusted by a modified programming of the plc/ips or by modified setting of the monitoring time "time value (ms)".

A fault recognized and stored with the CM-WDS can be reset by an H-impulse (0-1-transition) on the reset input "R(9)", so that the cycle monitoring is again released. The reset impulse can be generated by means of a reset button or by suitable programming of the controller (plc/ipc).

Ordering details

Rated control supply voltage	Reference code	Catalog number	Weight (1 pce) kg (lb)
24 V DC	CM-WDS	1SVR430896R000	0.15 (0.33)

Function diagram CM-WDS

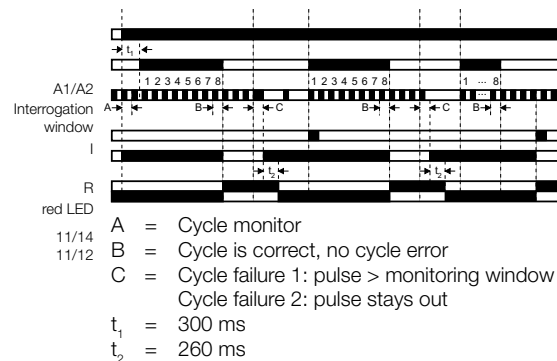

Connection diagram CM-WDS

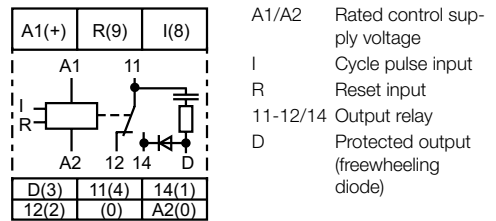

Characteristics

- Cycle monitor for monitoring the function of programmable logic controllers or industrial pcs
- 4 selectable cycle monitoring time ranges from 0.5 to 1000 ms
- 24 V DC supply
- 1 c/o contact
- 2 LEDs for status indication

Example of application - circuit diagram

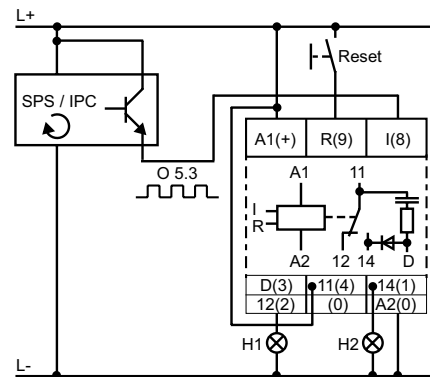

Application

The CM-WDS is designed for the external monitoring of the correct function of programmable logic controllers (plc) and industrial pcs (ipc).



CM-WDS

Cycle monitoring relay with watchdog function

Technical data

Type		CM-WDS
Input circuit		A1-A2
Rated control supply voltage U_s - power consumption A1-A2		24 V DC - approx. 1 W
Tolerance of the rated control supply voltage U_s		-30 % - +30 %
Duty time		100 %
Measuring circuit		I
Monitoring function		cycle monitoring
Measuring voltage		24 V DC
Current consumption at the measuring input		approx. 5 mA
Setting range of cycle monitoring time		selectable: 0.5-150 ms, 0.5-260 ms, 0.5-500 ms, 0.5-1000 ms
Response time		approx. 0.5-1000 ms
Accuracy within the supply voltage tolerance		$\Delta U \leq 0.5 \%$
Accuracy within the temperature range		$\Delta U \leq 0.06 \%$ / °C
Timing circuit		
ON-delay		approx. 2.2-10 s
Indication of operational states		
Control supply voltage		U: green LED
Output relay de-energized / cycle error		F: red LED
Output circuit		11-12/14
Kind of output		1 c/o
Operating principle ¹⁾		Closed-circuit principle
Contact material		AgCdo
Rated operational voltage U_o IEC/EN 60947-1		250 V
Minimum switching voltage / Minimum switching current		
Maximum switching voltage		250 V AC, 250 V DC
Rated operational current I_o (IEC/EN 60947-5-1)	AC12 (resistive) 230 V	4 A
	AC15 (inductive) 230 V	3 A
	DC12 (resistive) 24 V	4 A
	DC13 (inductive) 24 V	2 A
AC rating (UL 508)	Utilization category (Control Circuit Rating Code)	B 300
	max. rated operational voltage	300 V AC
	max. continuous thermal current at B 300	5 A
	max. making/breaking apparent power at B 300	3600/360 VA
Mechanical lifetime		10 x 10 ⁸ switching cycles
Electrical lifetime (AC12, 230 V, 4 A)		0.1 x 10 ⁸ switching cycles
Max. fuse rating to achieve short-circuit protection	n/c / n/o contacts	10 A fast-acting / 10 A fast-acting
General data		
Dimensions (W x H x D)		22.5 x 78 x 100 mm (0.89 x 3.07 x 3.94 in)
Mounting position		any
Degree of protection	enclosure / terminals	IP50 / IP20
Ambient temperature range	operation / storage	-20...+60 °C / -40...+85 °C
Mounting		DIN rail (IEC/EN 60715)
Electrical connection		
Wire size	fine-strand with wire end ferrule	2 x 2.5 mm ² (2 x 14 AWG)
Standards		
Product standard		IEC 255-6, EN 60255-6
Low Voltage Directive		2006/95/EC
EMC Directive		2004/108/EC
Operational reliability (IEC 68-2-6)		4 g
Mechanical shock resistance (IEC 68-2-6)		6 g
Electromagnetic compatibility		
Interference immunity to		EN 61000-6-2
electrostatic discharge	IEC/EN 61000-4-2	Level 3 (6 kV / 8 kV)
radiated, radio-frequency, electromagnetic field	IEC/EN 61000-4-3	Level 3 (10 V/m)
electrical fast transient / burst	IEC/EN 61000-4-4	Level 3 (2 kV / 5 kHz)
surge	IEC/EN 61000-4-5	Level 3 (2 kV L-L)
conducted disturbances, induced by radio-frequency fields	IEC/EN 61000-4-6	Level 3 (10 V)
Interference emission		EN 61000-6-4
Isolation data		
Rated insulation voltage between supply-, control- and output circuit (VDE 0110, IEC 60947-1)		250 V
Rated impulse withstand between all isolated circuits (VDE 0110, IEC 664)		4 kV / 1.2-50 μ s
Test voltage between all isolated circuits		2.5 kV, 50 Hz, 1 min
Pollution degree (VDE 0110, IEC 664, IEC 255-5)		3/C
Overvoltage category (VDE 0110, IEC 664, IEC 255-5)		III
Environmental tests (IEC 68-2-30)		24 h cycle, 55 °C, 93 % rel. 96 h

¹⁾ Closed-circuit principle: Output relay de-energizes if a cycle error occurs

General technical data

Load limit curves

Load limit curves

CM-S (22.5 mm), CM-E (22.5 mm)

AC load (resistive)

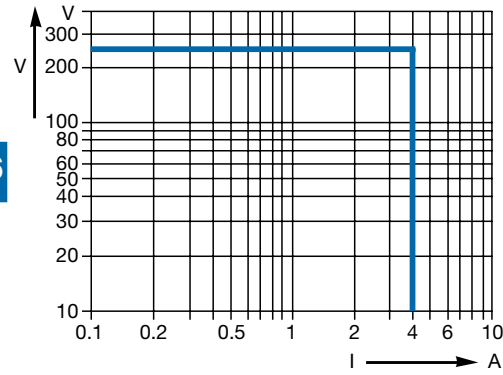

DC load (resistive)

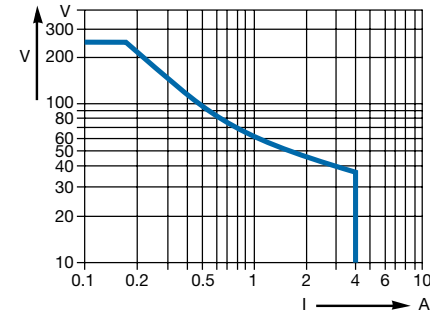

Derating factor F for inductive AC load

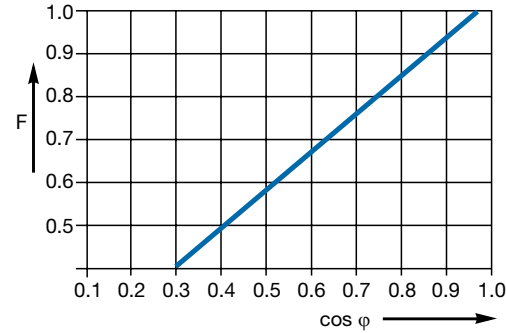

Contact lifetime

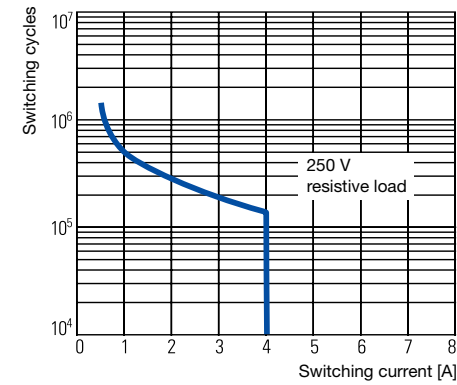

CM-N (45 mm)

AC load (resistive)

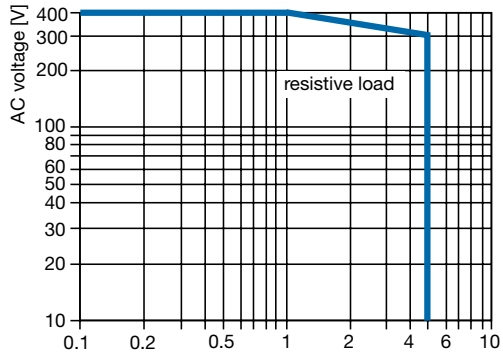

DC load (resistive)

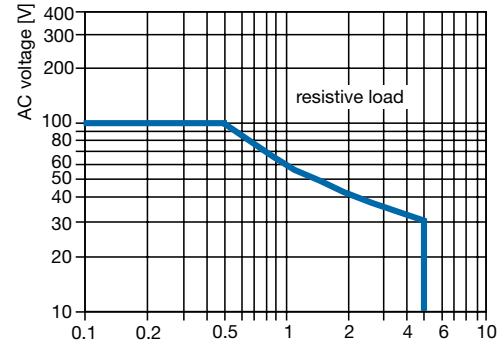

Derating factor F for inductive AC load

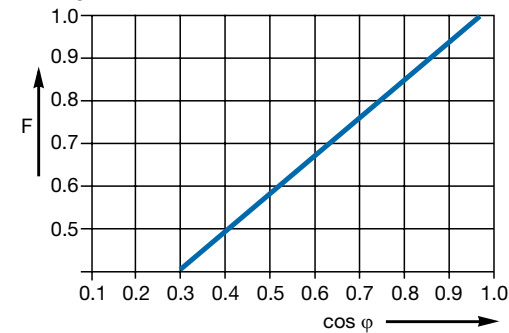

Contact lifetime

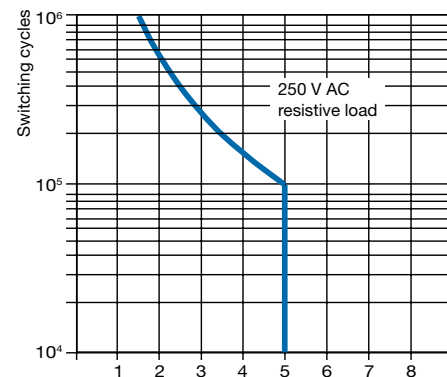

General technical data

Approximate dimensions

Measuring and monitoring relays CM range old housing

Dimensions in mm

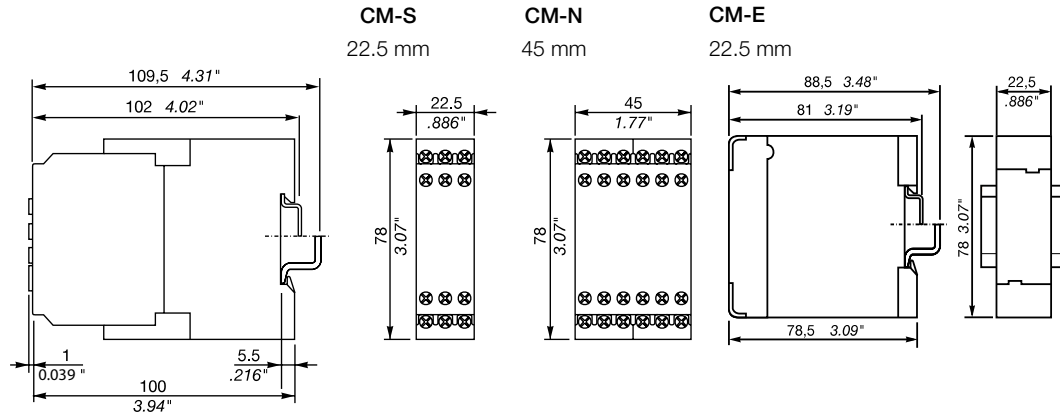

Measuring and monitoring relays CM range new housing

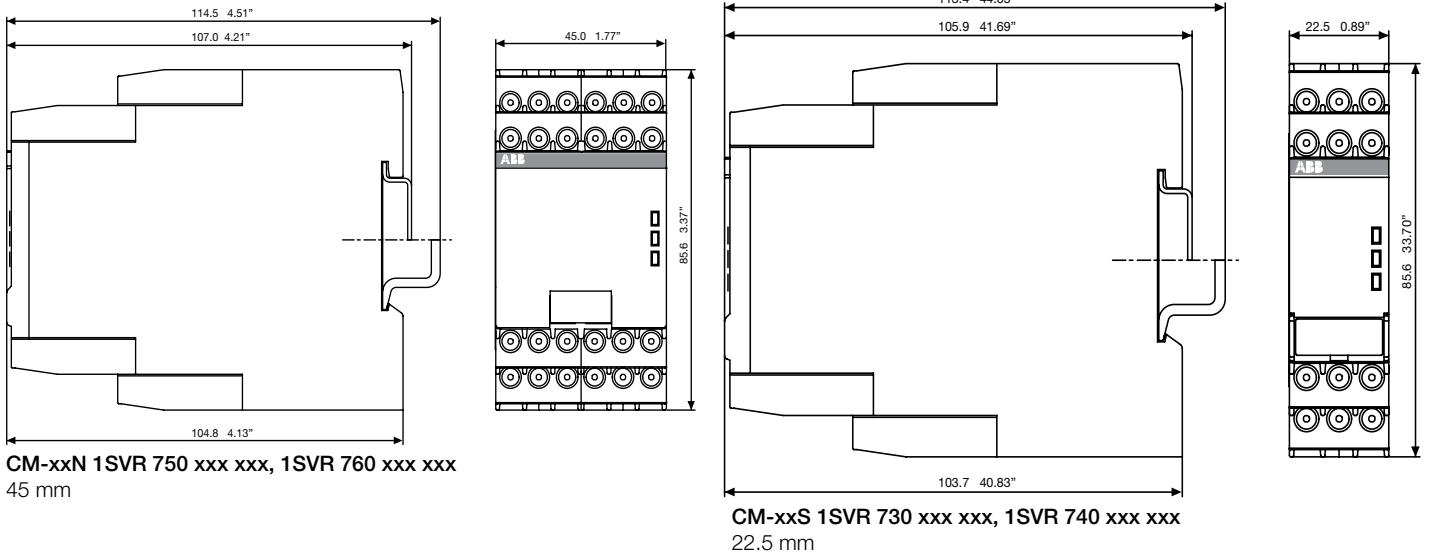

Temperature monitoring relays

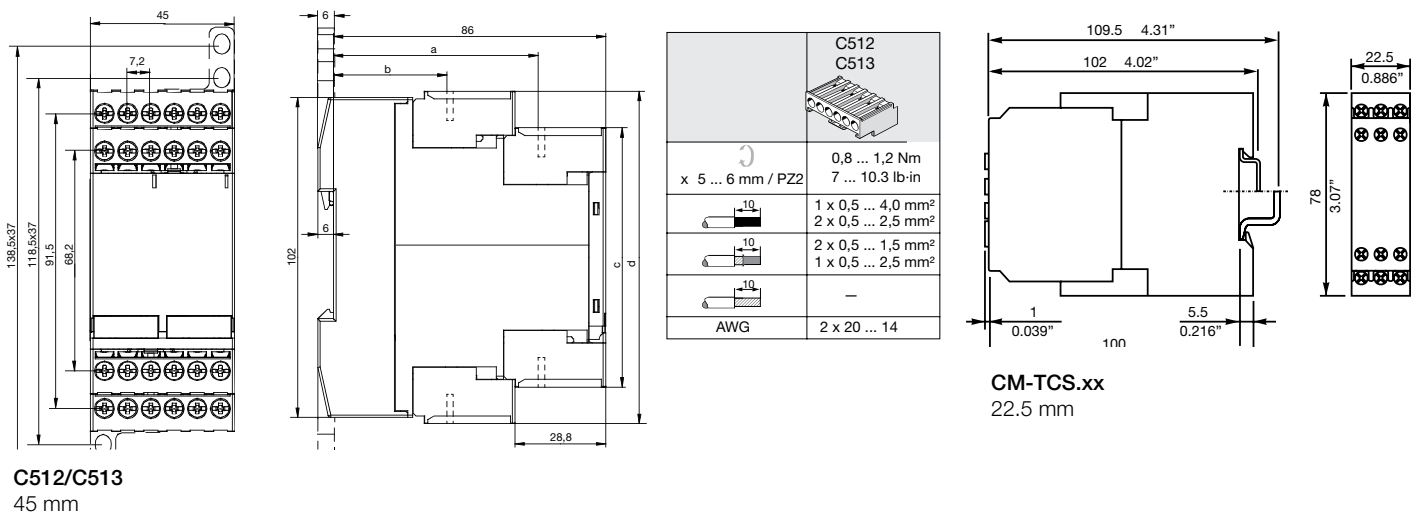

Accessories

Ordering details

Accessories

Ordering details

Description	For type	Width in mm	for devices	Reference code	Catalog number	Pkg qty	Weight (1 pce) g (oz)
Adapter for screw mounting	CM-S	22.5		ADP.01	1SVR430029R0100	1	18.4 (0.65)
	CM-N	45		ADP.02	1SVR440029R0100	1	36.7 (1.30)
Marker label	CM-S, CM-N		without DIP switches	MAR.01	1SVR366017R0100	10	0.19 (0.007)
	CM-S, CM-N		with DIP switches	MAR.02	1SVR430043R0000	10	0.13 (0.005)
	CM-S, CM-N in new housing		with DIP switches	MAR.12	1SVR730006R0000	10	0.152 (0.335)
Sealable transparent cover	CM-S	22.5		COV.01	1SVR430005R0100	1	5.2 (0.18)
	CM-N	45		COV.02	1SVR440005R0100	1	7.7 (0.27)
	CM-S.S/P	22.5		COV.11	1SVR730005R0100	1	4.0 (0.129)
	CM-N.S/P	45		COV.12	1SVR750005R0100	1	7 (0.247)

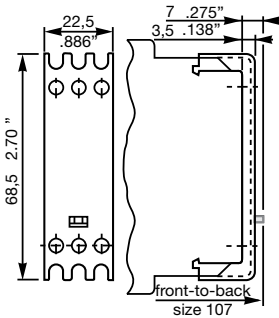
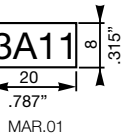
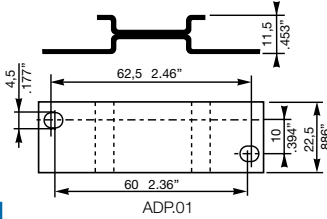

Sealable cover
COV.01

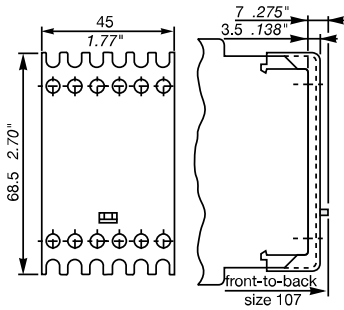

Sealable cover
COV.02

Accessories

Ordering details



CM-CT



CM-CT with mounted accessories

Plug-in current transformers CM-CT

- Without primary conductor though with foot angle, insulating protective cap and bar fastening screws
- Primary / rated current from 50 A to 600 A
- Secondary current of 1 A or 5 A
- Class 1

Ordering details

Rated primary current	Secondary current	Burden class	Reference code	Catalog number	Weight (1 pce) g (oz)
50 A	1 A	1 VA / 1	CM-CT 50/1	1SVR450116R1000	0.31 (0.683)
75 A		1.5 VA / 1	CM-CT 75/1	1SVR450116R1100	0.31 (0.683)
100 A		2.5 VA / 1	CM-CT 100/1	1SVR450116R1200	0.276 (0.608)
150 A		2.5 VA / 1	CM-CT 150/1	1SVR450116R1300	0.32 (0.705)
200 A		2.5 VA / 1	CM-CT 200/1	1SVR450116R1400	0.222 (0.489)
300 A		5 VA / 1	CM-CT 300/1	1SVR450117R1100	0.29 (0.639)
400 A		5 VA / 1	CM-CT 400/1	1SVR450117R1200	0.27 (0.595)
500 A		5 VA / 1	CM-CT 500/1	1SVR450117R1300	0.29 (0.639)
600 A		5 VA / 1	CM-CT 600/1	1SVR450117R1400	0.24 (0.529)
50 A		5 A	1 VA / 1	CM-CT 50/5	1SVR450116R5000
75 A	1.5 VA / 1		CM-CT 75/5	1SVR450116R5100	0.31 (0.683)
100 A	2.5 VA / 1		CM-CT 100/5	1SVR450116R5200	0.31 (0.683)
150 A	2.5 VA / 1		CM-CT 150/5	1SVR450116R5300	0.28 (0.617)
200 A	5 VA / 1		CM-CT 200/5	1SVR450116R5400	0.29 (0.639)
300 A	5 VA / 1		CM-CT 300/5	1SVR450117R5100	0.252 (0.556)
400 A	5 VA / 1		CM-CT 400/5	1SVR450117R5200	0.26 (0.573)
500 A	5 VA / 1		CM-CT 500/5	1SVR450117R5300	0.208 (0.459)
600 A	5 VA / 1		CM-CT 600/5	1SVR450117R5400	0.21 (0.463)

Ordering details - Accessories

Description	Reference code	Catalog number	Weight (1 pce) g (oz)
Snap-on fastener for DIN rail mounting of CM-CT	CM-CT A	1SVR450118R1000	0.009 (0.02)



CM-CT-A mounted on DIN rail

Operating principle / circuit diagram

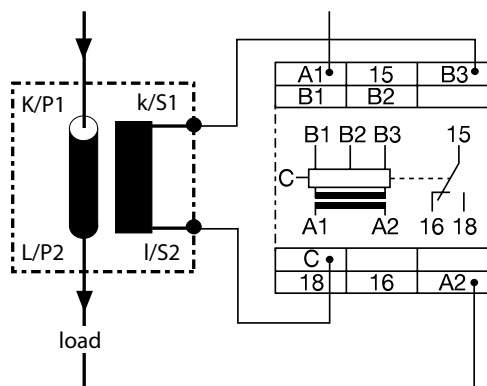

Dimensional drawing

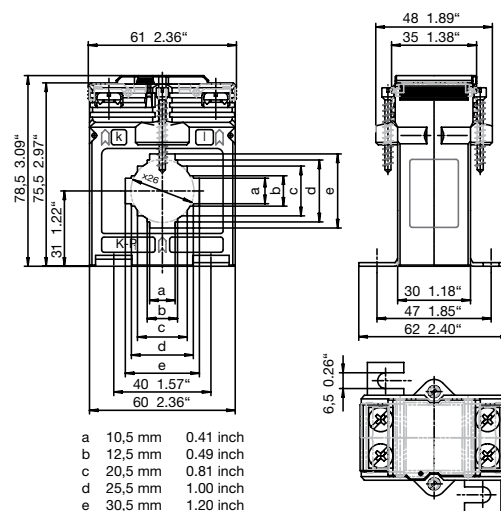

Notes

CR Range Interface Relays & optocouplers



CR Range
Interface relays & optocouplers

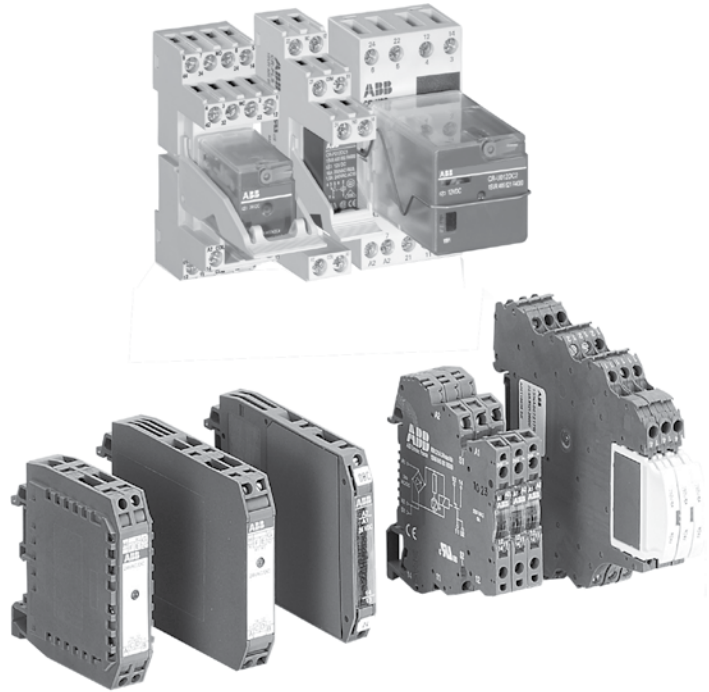

Notes

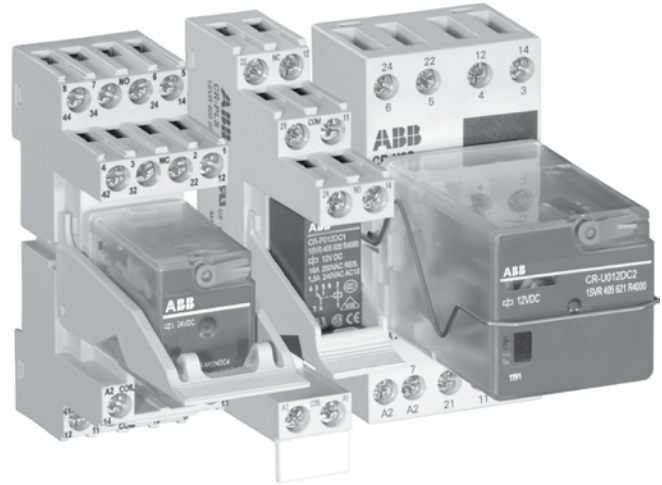

CR Range Interface Relays

Pluggable interface relays Benefits and advantages

6

Pluggable pcb relays CR-P

- 9 different coil voltages
 - DC versions: 12 V, 24 V, 48 V, 110 V
 - AC versions: 24 V, 48 V, 110 V, 120 V, 230 V
- Output contacts:
 - 1 c/o contact (16 A) or
 - 2 c/o contacts (8 A) optionally equipped with gold contacts
- Logical or standard sockets
- Cadmium-free contact material
- Width on socket: 15,5 mm
- Pluggable function modules
 - Reverse polarity protection/ Free wheeling diode
 - LED indication
 - RC elements
 - Overvoltage protection

Pluggable miniature relays CR-M

- 12 different coil voltages
 - DC versions: 12 V, 24 V, 48 V, 60 V, 110 V, 125 V, 220 V
 - AC versions: 24 V, 48 V, 60 V, 110 V, 120 V, 230 V
- Output contacts
 - 2 c/o contacts (12 A) or
 - 3 c/o contacts (10 A) or
 - 4 c/o contacts (6 A) optionally equipped with gold contacts, LED and free wheeling diode
- Integrated test button for manual actuation and locking of the output contacts (blue = DC, orange = AC) that can be removed if necessary
- With or without integrated LED
- Logical or standard sockets
- Cadmium-free contact material
- Width on socket: 27 mm
- Pluggable function modules
 - Reverse polarity protection/ Free wheeling diode
 - LED indication
 - RC elements
 - Overvoltage protection

Pluggable universal relays CR-U

- 10 different coil voltages
 - DC versions: 12 V, 24 V, 48 V, 110 V, 125 V, 220 V
 - AC versions: 24 V, 48 V, 60 V, 110 V, 120 V, 230 V
- Output contacts
 - 2 c/o contacts (10 A) or
 - 3 c/o contacts (10 A)
- Integrated test button for manual actuation and locking of the output contacts (blue = DC, orange = AC) that can be removed if necessary
- With or without integrated LED
- Cadmium-free contact material
- Width on socket: 38 mm
- Pluggable function modules
 - Reverse polarity protection/ Free wheeling diode
 - LED indication
 - RC elements
 - Overvoltage protection
 - Multifunction time module

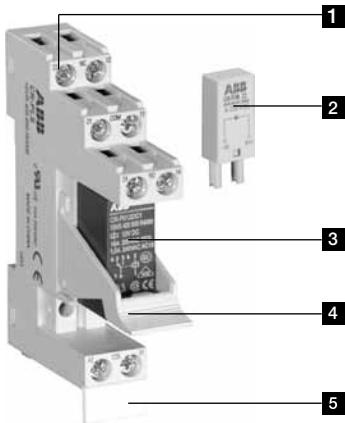

- 1** Socket
- 2** Pluggable function module
- 3** Interface relay
- 4** Holder
- 5** Marker label

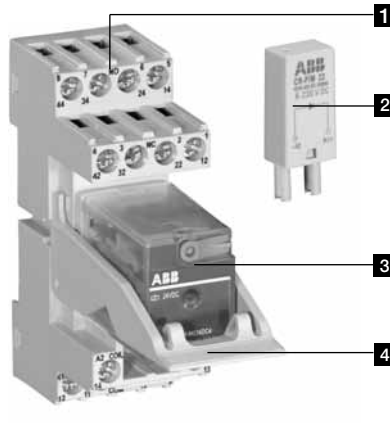

- 1** Socket
- 2** Pluggable function module
- 3** Interface relay
- 4** Holder

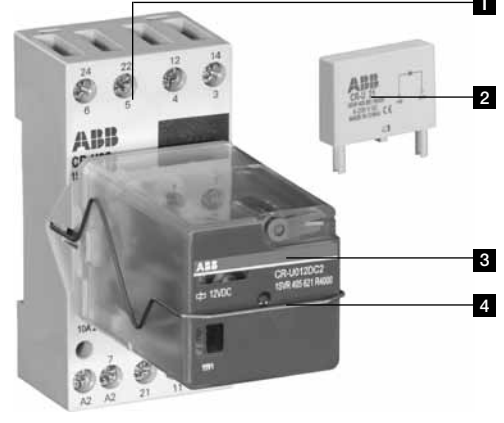

- 1** Socket
- 2** Pluggable function module
- 3** Interface relay
- 4** Holder

Pluggable interface relays

Approvals and marks

Kinds of sockets

Standard sockets - Position of connecting terminals:

Coil connection (A1-A2) on lower socket side, contact connections (n/o and n/c contacts) on the lower and upper socket side.

Logical sockets - Position of connecting terminals:

Coil connection (A1-A2) on lower socket side, all contact connections (common contacts, n/o and n/c contacts) on upper socket side.

Details see connection diagrams

Kind of connecting terminals

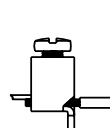

Screw type



Spring type

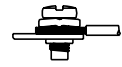

Fork type

Approvals and marks

		Relays			Sockets							Modules	
		CR-P	CR-M	CR-U	CR-PLS CR-PSS	CR-PLC	CR-M..L. CR-M..SS	CR-M..SF	CR-U..S CR-U..E	CR-U..SM	CR-P/M	CR-U	
Approvals													
	UL 508	■	■ ¹⁾	■									
	CAN/CSA C22.2 No.14	■	■ ²⁾	■	■	■	■	■	■	■	■ ⁶⁾	■ ⁷⁾	
	CAN/CSA C22.2 No.14	■	■ ³⁾	■									
	VDE	■	■ ⁴⁾	■									
	GOST	■	■	■	■	■	■	■	■	■	■	■	
	Lloyds Register		■ ⁵⁾	■									
	CCC	■	■	■									
	RMRS	■	■	■	■	■	■	■	■	■			
Marks													
	CE	■	■	■	■	■	■	■	■	■	■	■	

¹⁾ except 60 V DC and 125 V DC devices with gold contacts

²⁾ except devices with gold contacts

³⁾ except 60 V DC and 125 V DC devices

⁴⁾ except 125 V DC devices

⁵⁾ only devices with 4 c/o contacts

⁶⁾ except CR-P/M 42B, CR-P/M 42BV, CR-P/M 42C, CR-P/M 42CV, CR-P/M 52D, CR-P/M 62E, CR-P/M 62EV, CR-P/M 62D, CR-P/M 62DV

⁷⁾ except CR-U 41B, CR-U 41BV, CR-U 41C, CR-U 41CV, CR-U 51D, CR-U 61CV, CR-U 61E, CR-U 61EV, CR-U 61D, CR-U 61DV, CR-U 91C, CR-U T

Pluggable interface relays

Ordering details

6



CR-P

Description

Interface relays are widely used in various industrial applications:

As an interface they link the electronic controlling, e.g. PLC (programmable logic controller), PC or field bus systems, to the sensor / actuator level. Here, they take on various functions: Switching of AC or DC loads with different resistive, inductive and capacitive parts, switching voltages from a few mV up to 250 V, switching currents from a few mA up to 16 A, amplification of weak control signals, electrical isolation of control and load circuits, and signal multiplying. In contrast to electronic switching devices, interface relays don't use additional internal protective circuits and thus are overload-proof against short-time variations like current or voltage peaks.

Ordering details - CR-P range

Rated control supply voltage	Outputs	Contact ratings	Reference code	Catalog number	Pkg	Weight
					qty	(1 pce) kg (lb)
12 V DC	1 c/o (SPDT)	250 V, 16 A	CR-P012DC1	1SVR405600R4000	10	0.014 (0.031)
24 V DC			CR-P024DC1	1SVR405600R1000		
48 V DC			CR-P048DC1	1SVR405600R6000		
110 V DC			CR-P110DC1	1SVR405600R8000		
24 V AC			CR-P024AC1	1SVR405600R0000		
48 V AC			CR-P048AC1	1SVR405600R5000		
110 V AC			CR-P110AC1	1SVR405600R7000		
120 V AC			CR-P120AC1	1SVR405600R2000		
230 V AC			CR-P230AC1	1SVR405600R3000		
12 V DC			2 c/o (SPDT)	250 V, 8 A		
24 V DC	CR-P024DC2	1SVR405601R1000				
48 V DC	CR-P048DC2	1SVR405601R6000				
110 V DC	CR-P110DC2	1SVR405601R8000				
24 V AC	CR-P024AC2	1SVR405601R0000				
48 V AC	CR-P048AC2	1SVR405601R5000				
110 V AC	CR-P110AC2	1SVR405601R7000				
120 V AC	CR-P120AC2	1SVR405601R2000				
230 V AC	CR-P230AC2	1SVR405601R3000				
24 V DC	2 c/o gold contact	250 V, 8 A			CR-P024DC2	1SVR405606R1000
24 V AC			CR-P024AC2G	1SVR405606R0000		
110 V AC			CR-P110AC2G	1SVR405606R7000		
230 V AC			CR-P230AC2G	1SVR405606R3000		



CR-PLS

Ordering details - Accessories

Version	Connection terminal	Reference code	Catalog number	Pkg	Weight
				qty	(1 pce) kg (lb)
Logical socket with protective separation	screw	CR-PLS	1SVR405650R0000	10	0.045 (0.099)
Logical socket	screw	CR-PLSx	1SVR405650R0100		0.043 (0.095)
Logical socket	spring	CR-PLC	1SVR405650R0200		0.042 (0.093)
Standard socket	screw	CR-PSS	1SVR405650R1000		0.038 (0.084)
Plastic Holder for socket		CR-PH	1SVR405659R0000	10	0.002 (0.004)
Jumper bar for sockets with screw connection		CR-PJ	1SVR405658R5000		0.018 (0.040)
Marker		CR-PM	1SVR405658R0000	10	0.0002 (0.0004)



CR-PJ

Pluggable interface relays

Ordering details

Interface relays
CR Range



CR-M

Description

Interface relays are widely used in various industrial applications:

As an interface they link the electronic controlling, e.g. PLC (programmable logic controller), PC or field bus systems, to the sensor / actuator level. Here, they take on various functions: Switching of AC or DC loads with different resistive, inductive and capacitive parts, switching voltages from a few mV up to 250 V, switching currents from a few mA up to 16 A, amplification of weak control signals, electrical isolation of control and load circuits, and signal multiplying. In contrast to electronic switching devices, interface relays don't use additional internal protective circuits and thus are overload-proof against short-time variations like current or voltage peaks.

Ordering details - CR-M range

Rated control supply voltage	Outputs	Contact ratings	Reference code	Catalog number	Pkg	Weight
					qty	(1 pce) kg (lb)
12 V DC	2 c/o (SPDT) without LED	250 V, 12 A	CR-M012DC2	1SVR405611R4000	10	0.033 (0.073)
24 V DC			CR-M024DC2	1SVR405611R1000		
48 V DC			CR-M048DC2	1SVR405611R6000		
60 V DC			CR-M060DC2	1SVR405611R4200		
110 V DC			CR-M110DC2	1SVR405611R8000		
125 V DC			CR-M125DC2	1SVR405611R8200		
220 V DC			CR-M220DC2	1SVR405611R9000		
24 V AC			CR-M024AC2	1SVR405611R0000		
48 V AC			CR-M048AC2	1SVR405611R5000		
110 V AC			CR-M110AC2	1SVR405611R7000		
120 V AC			CR-M120AC2	1SVR405611R2000		
230 V AC			CR-M230AC2	1SVR405611R3000		
12 V DC			3 c/o (SPDT) without LED	250 V, 10 A		
24 V DC	CR-M024DC3	1SVR405612R1000				
48 V DC	CR-M048DC3	1SVR405612R6000				
60 V DC	CR-M060DC3	1SVR405612R4200				
110 V DC	CR-M110DC3	1SVR405612R8000				
125 V DC	CR-M125DC3	1SVR405612R8200				
220 V DC	CR-M220DC3	1SVR405612R9000				
24 V AC	CR-M024AC3	1SVR405612R0000				
48 V AC	CR-M048AC3	1SVR405612R5000				
110 V AC	CR-M110AC3	1SVR405612R7000				
120 V AC	CR-M120AC3	1SVR405612R2000				
230 V AC	CR-M230AC3	1SVR405612R3000				
12 V DC	4 c/o (SPDT) without LED	250 V, 6 A			CR-M012DC4	1SVR405613R4000
24 V DC			CR-M024DC4	1SVR405613R1000		
48 V DC			CR-M048DC4	1SVR405613R6000		
60 V DC			CR-M060DC4	1SVR405613R4200		
110 V DC			CR-M110DC4	1SVR405613R8000		
125 V DC			CR-M125DC4	1SVR405613R8200		
220 V DC			CR-M220DC4	1SVR405613R9000		
24 V AC			CR-M024AC4	1SVR405613R0000		
48 V AC			CR-M048AC4	1SVR405613R5000		
110 V AC			CR-M110AC4	1SVR405613R7000		
120 V AC			CR-M120AC4	1SVR405613R2000		
230 V AC			CR-M230AC4	1SVR405613R3000		

Pluggable interface relays

Ordering details



CR-M

Ordering details - CR-M range

Rated control supply voltage	Outputs	Contact ratings	Reference code	Catalog number	Pkg	Weight				
					qty	(1 pce) kg (lb)				
12 V DC	2 c/o (SPDT) with LED	250 V, 12 A	CR-M012DC2L	1SVR405611R4100	10	0.033 (0.073)				
24 V DC			CR-M024DC2L	1SVR405611R1100						
48 V DC			CR-M048DC2L	1SVR405611R6100						
60 V DC			CR-M060DC2L	1SVR405611R4300						
110 V DC			CR-M110DC2L	1SVR405611R8100						
125 V DC			CR-M125DC2L	1SVR405611R8300						
220 V DC			CR-M220DC2L	1SVR405611R9100						
24 V AC			CR-M024AC2L	1SVR405611R0100						
48 V AC			CR-M048AC2L	1SVR405611R5100						
110 V AC			CR-M110AC2L	1SVR405611R7100						
120 V AC			CR-M120AC2L	1SVR405611R2100						
230 V AC			CR-M230AC2L	1SVR405611R3100						
12 V DC			3 c/o (SPDT) with LED	250 V, 10 A			CR-M012DC3L	1SVR405612R4100	10	0.033 (0.073)
24 V DC							CR-M024DC3L	1SVR405612R1100		
48 V DC							CR-M048DC3L	1SVR405612R6100		
60 V DC	CR-M060DC3L	1SVR405612R4300								
110 V DC	CR-M110DC3L	1SVR405612R8100								
125 V DC	CR-M125DC3L	1SVR405612R8300								
220 V DC	CR-M220DC3L	1SVR405612R9100								
24 V AC	CR-M024AC3L	1SVR405612R0100								
48 V AC	CR-M048AC3L	1SVR405612R5100								
110 V AC	CR-M110AC3L	1SVR405612R7100								
120 V AC	CR-M120AC3L	1SVR405612R2100								
230 V AC	CR-M230AC3L	1SVR405612R3100								
12 V DC	4 c/o (SPDT) with LED	250 V, 6 A			CR-M012DC4L	1SVR405613R4100	10	0.033 (0.073)		
24 V DC					CR-M024DC4L	1SVR405613R1100				
48 V DC					CR-M048DC4L	1SVR405613R6100				
60 V DC			CR-M060DC4L	1SVR405613R4300						
110 V DC			CR-M110DC4L	1SVR405613R8100						
125 V DC			CR-M125DC4L	1SVR405613R8300						
220 V DC			CR-M220DC4L	1SVR405613R9100						
24 V AC			CR-M024AC4L	1SVR405613R0100						
48 V AC			CR-M048AC4L	1SVR405613R5100						
110 V AC			CR-M110AC4L	1SVR405613R7100						
120 V AC			CR-M120AC4L	1SVR405613R2100						
230 V AC2			CR-M230AC4L	1SVR405613R3100						
24 V DC			4 c/o (SPDT) LED and free-wheeling diode	250 V, 6 A	CR-M024DC4LD	1SVR405614R1100			10	0.033 (0.073)
24 V DC			4 (SPDT) c/o gold contacts	250 V, 6 A	CR-M024DC4G	1SVR405618R1000			10	0.033 (0.073)
24 V AC					CR-M024AC4G	1SVR405618R0000				
110 V AC	CR-M110AC4G	1SVR405618R7000								
230 V AC	CR-M230AC4G	1SVR405618R3000								

Pluggable interface relays

Ordering details

Interface relays
CR Range



CR-M

Rated control supply voltage	Outputs	Contact ratings	Reference code	Catalog number	Pkg	Weight				
					qty	(1 pce) kg (lb)				
12 V DC	4 c/o (SPDT) with gold contacts and LED	250 V / 6 A	CR-M012DC4LG	1SVR405618R4100	10	0.033 (0.073)				
24 V DC			CR-M024DC4LG	1SVR405618R1100						
48 V DC			CR-M048DC4LG	1SVR405618R6100						
60 V DC			CR-M060DC4LG	1SVR405618R4300						
110 V DC			CR-M110DC4LG	1SVR405618R8100						
125 V DC			CR-M125DC4LG	1SVR405618R8300						
220 V DC			CR-M220DC4LG	1SVR405618R9100						
24 V AC			CR-M024AC4LG	1SVR405618R0100	10	0.033 (0.073)				
48 V AC			CR-M048AC4LG	1SVR405618R5100						
110 V AC			CR-M110AC4LG	1SVR405618R7100						
120 V AC			CR-M120AC4LG	1SVR405618R2100						
230 V AC			CR-M230AC4LG	1SVR405618R3100						
12 V DC			4 c/o (SPDT) with gold contacts, LED and free-wheeling diode				CR-M012DC4LDG	1SVR405618R4400	10	0.033 (0.073)
24 V DC							CR-M024DC4LDG	1SVR405618R1400		

6



CR-M4SS



CR-MJ

Ordering details - Accessories

Version	Connection terminal	Reference code	Catalog number	Pkg	Weight
				qty	(1 pce) kg (lb)
Logical socket for 2 c/o	screw	CR-M2LS	1SVR405651R1100	10	0.055 (0.121)
Logical socket for 3 c/o		CR-M3LS	1SVR405651R2100		0.062 (0.137)
Logical socket for 2/4 c/o		CR-M4LS	1SVR405651R3100		0.066 (0.146)
Logical socket for 2 c/o	spring	CR-M2LC	1SVR405651R1200	10	0.065 (0.143)
Logical socket for 2/4 c/o		CR-M4LC	1SVR405651R3200		0.066 (0.146)
Standard socket for 2 c/o	screw	CR-M2SS	1SVR405651R1000	10	0.066 (0.146)
Standard socket for 3 c/o		CR-M3SS	1SVR405651R2000		0.068 (0.150)
Standard socket for 2/4 c/o		CR-M4SS	1SVR405651R3000		0.070 (0.154)
Standard socket for 2 c/o	fork type	CR-M2SF	1SVR405651R1300	10	0.040 (0.088)
Standard socket for 2/4 c/o		CR-M4SF	1SVR405651R3300		0.048 (0.106)
Plastic holder		CR-MH	1SVR405659R1000	10	0.003 (0.007)
Metal holder		CR-MH1	1SVR405659R1100	10	0.0005 (0.001)
CR-MJ		CR-MJ	1SVR405658R6000	10	0.029 (0.064)
CR-M		CR-MM	1SVR405658R1000	10	0.0005 (0.001)

Pluggable interface relays

Ordering details



CR-P/M ...

Ordering details - CR-P/M range

Rated control supply voltage	Description	Version	Reference code	Catalog number	Pkg	Weight
					qty	(1 pce) kg (lb)
6-230 V DC	Diode - Reverse polarity protection/ free wheeling diode	A1+, A2-	CR-P/M 22	1SVR405651R0000	10	0.003 (0.007)
6-24 V DC	Diode and LED - Reverse polarity protection/ free wheeling diode	red, A1+, A2-	CR-P/M 42	1SVR405652R0000	10	0.003 (0.007)
24-60 V DC		green, A1+, A2-	CR-P/M 42V	1SVR405652R1000		
110-230 V DC		red, A1+, A2-	CR-P/M 42B	1SVR405652R4000		
		green, A1+, A2-	CR-P/M 42BV	1SVR405652R4100		
		red, A1+, A2-	CR-P/M 42C	1SVR405652R9000		
		green, A1+, A2-	CR-P/M 42CV	1SVR405652R9100		
6-24 V AC	Spark quenching		CR-P/M 52B	1SVR405653R0000	10	0.003 (0.007)
24-60 V AC			CR-P/M 52D	1SVR405653R4000		
110-230 V AC			CR-P/M 52C	1SVR405653R1000		
6-24 V AC/DC	Diode and LED	red, for DC A1+, A2-	CR-P/M 62	1SVR405654R0000	10	0.003 (0.007)
		green, for DC A1+, A2-	CR-P/M 62V	1SVR405654R1000		
24-60 V AC/DC		red, for DC A1+, A2-	CR-P/M 62E	1SVR405654R4000		
		green, for DC A1+, A2-	CR-P/M 62EV	1SVR405654R4100		
110-230 V AC/DC		red, for DC A1+, A2-	CR-P/M 92	1SVR405654R0100		
		green, for DC A1+, A2-	CR-P/M 92V	1SVR405654R1100		
6-24 V AC/DC	Varistor and LED Overvoltage protection	red, for DC A1+, A2-	CR-P/M 62C	1SVR405655R0000	10	0.003 (0.007)
		green, for DC A1+, A2-	CR-P/M 62CV	1SVR405655R1000		
24-60 V AC/DC		red, for DC A1+, A2-	CR-P/M 62D	1SVR405655R4000		
		green, for DC A1+, A2-	CR-P/M 62DV	1SVR405655R4100		
110-230 V AC/DC		red, for DC A1+, A2-	CR-P/M 92C	1SVR405655R0100		
		green, for DC A1+, A2-	CR-P/M 92CV	1SVR405655R1100		
24 V AC	Overvoltage protection		CR-P/M 72	1SVR405656R0000	10	0.002 (0.004)
115 V AC			CR-P/M 72A	1SVR405656R1000		
230 V AC			CR-P/M 82	1SVR405656R2000		

Connection diagrams

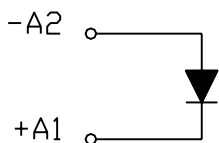

CR-P/M 22

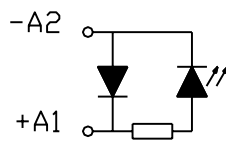

CR-P/M 42, P/M 42C, P/M 42BV, CR-P/M 42B, CR-P/M 42V, CR-P/M 42CV

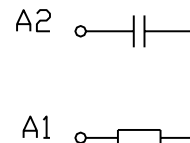

CR-P/M 52B, CR-P/M 52D, CR-P/M 52C

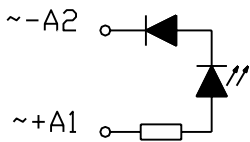

CR-P/M 62, P/M 92, P/M 62EV, CR-P/M 62E, CR-P/M 92V, CR-P/M 62V, CR-P/M 92V

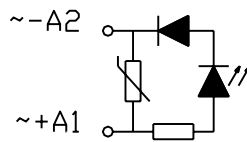

CR-P/M 62C, P/M 62DV, CR-P/M 62D, CR-P/M 92C, CR-P/M 62CV, CR-P/M 92CV

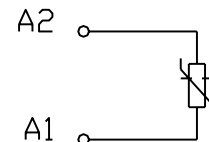

CR-P/M 72, CR-P/M 72A, CR-P/M 82

Pluggable interface relays

Ordering details

Interface relays
CR Range



CR-U

Description

Interface relays are widely used in various industrial applications: As an interface they link the electronic controlling, e.g. PLC (programmable logic controller), PC or field bus systems, to the sensor / actuator level. Here, they take on various functions: Switching of AC or DC loads with different resistive, inductive and capacitive parts, switching voltages from a few mV up to 250 V, switching currents from a few mA up to 16 A, amplification of weak control signals, electrical isolation of control and load circuits, and signal multiplying. In contrast to electronic switching devices, interface relays don't use additional internal protective circuits and thus are overload-proof against short-time variations like current or voltage peaks.

Ordering details - CR-U range

Rated control supply voltage	Outputs	Contact ratings	Reference code	Catalog number	Pkg qty	Weight (1 pce) kg (lb)				
12 V DC	2 c/o without LED	250 V, 10 A	CR-U012DC2	1SVR405621R4000	10	0.083 (0.183)				
24 V DC			CR-U024DC2	1SVR405621R1000						
48 V DC			CR-U048DC2	1SVR405621R6000						
110 V DC			CR-U110DC2	1SVR405621R8000						
220 V DC			CR-U220DC2	1SVR405621R9000						
24 V AC			CR-U024AC2	1SVR405621R0000						
48 V AC			CR-U048AC2	1SVR405621R5000						
110 V AC			CR-U110AC2	1SVR405621R7000						
120 V AC			CR-U120AC2	1SVR405621R2000						
230 V AC			CR-U230AC2	1SVR405621R3000						
12 V DC			3 c/o without LED	250 V, 10 A			CR-U012DC3	1SVR405622R4000	10	0.083 (0.183)
24 V DC							CR-U024DC3	1SVR405622R1000		
48 V DC	CR-U048DC3	1SVR405622R6000								
110 V DC	CR-U110DC3	1SVR405622R8000								
125 V DC	CR-U125DC3	1SVR405622R8200								
220 V DC	CR-U220DC3	1SVR405622R9000								
24 V AC	CR-U024AC3	1SVR405622R0000								
48 V AC	CR-U048AC3	1SVR405622R5000								
60 V AC	CR-U060AC3	1SVR405622R5200								
110 V AC	CR-U110AC3	1SVR405622R7000								
120 V AC	CR-U120AC3	1SVR405622R2000								
230 V AC	CR-U230AC3	1SVR405622R3000								
12 V AC	2 c/o with LED	250 V, 10 A	CR-U012DC2L	1SVR405621R4100	10	0.083 (0.183)				
24 V DC			CR-U024DC2L	1SVR405621R1100						
48 V DC			CR-U048DC2L	1SVR405621R6100						
110 V DC			CR-U110DC2L	1SVR405621R8100						
220 V DC			CR-U220DC2L	1SVR405621R9100						
24 V AC			CR-U024AC2L	1SVR405621R0100						
48 V AC			CR-U048AC2L	1SVR405621R5100						
110 V AC			CR-U110AC2L	1SVR405621R7100						
120 V AC			CR-U120AC2L	1SVR405621R2100						
230 V AC			CR-U230AC2L	1SVR405621R3100						
12 V DC			3 c/o with LED	250 V, 10 A			CR-U012DC3L	1SVR405622R4100	10	0.083 (0.183)
24 V DC							CR-U024DC3L	1SVR405622R1100		
48 V DC	CR-U048DC3L	1SVR405622R6100								
110 V DC	CR-U110DC3L	1SVR405622R8100								
220 V DC	CR-U220DC3L	1SVR405622R9100								
24 V AC	CR-U024AC3L	1SVR405622R0100								
48 V AC	CR-U048AC3L	1SVR405622R5100								
110 V AC	CR-U110AC3L	1SVR405622R7100								
120 V AC	CR-U120AC3L	1SVR405622R2100								
230 V AC	CR-U230AC3L	1SVR405622R3100								

Ordering details - Accessories



CR-U2S

Version	Reference code	Catalog number	Pkg qty	Weight (1 pce) kg (lb)
Socket for 2 c/o and module	CR-U2S	1SVR405670R0000	10	
Socket for 3 c/o and module	CR-U3S	1SVR405660R0000		
Socket for 3 c/o	CR-U3E	1SVR405660R0100		
Socket small for 2 c/o	CR-U2SM	1SVR405670R1100		
Socket small for 3 c/o	CR-U3SM	1SVR405660R1100		
Holder for CR-U socket	CR-UH	1SVR405669R0000		

Pluggable interface relays

Ordering details

Ordering details - CR-U range

Rated control supply voltage	Description	Version	Reference code	Catalog number	Pkg	Weight	
					qty	(1 pce) kg (lb)	
6-230 V DC	Diode - Reverse polarity protection/free wheeling diode	A1+, A2-	CR-U 21	1SVR405661R0000	10	0.007 (0.015)	
6-24 V DC	Diode and LED - Reverse polarity protection/free wheeling diode	red, A1+, A2- green, A1+, A2-	CR-U 41	1SVR405662R0000	10	0.007 (0.015)	
24-60 V DC		red, A1+, A2- green, A1+, A2-	CR-U 41B	1SVR405662R4000			
110-230 V DC		red, A1+, A2- green, A1+, A2-	CR-U 41C	1SVR405662R9000			
		red, A1+, A2- green, A1+, A2-	CR-U 41CV	1SVR405662R9100			
6-24 V AC 24-60 V AC 110-230 V AC	Spark quenching		CR-U 51B CR-U 51D CR-U 51C	1SVR405663R0000 1SVR405663R4000 1SVR405663R1000	10	0.007 (0.015)	
6-24 V AC/DC 24-60 V AC/DC 110-230 V AC/DC	Diode and LED	red, for DC A1+, A2- green, for DC A1+, A2-	CR-U 61	1SVR405664R0000	10	0.007 (0.015)	
24-60 V AC/DC		red, for DC A1+, A2- green, for DC A1+, A2-	CR-U 61V	1SVR405664R1000			
		red, for DC A1+, A2- green, for DC A1+, A2-	CR-U 61E	1SVR405664R4000			
110-230 V AC/DC		red, for DC A1+, A2- green, for DC A1+, A2-	CR-U 91	1SVR405664R0100			
6-24 V AC/DC 24-60 V AC/DC 110-230 V AC/DC	Varistor and LED Overvoltage protection	red, for DC A1+, A2- green, for DC A1+, A2-	CR-U 61C	1SVR405665R0000	10	0.007 (0.015)	
		red, for DC A1+, A2- green, for DC A1+, A2-	CR-U 61CV	1SVR405665R1000			
		red, for DC A1+, A2- green, for DC A1+, A2-	CR-U 61D	1SVR405665R4000			
		red, for DC A1+, A2- green, for DC A1+, A2-	CR-U 61DV	1SVR405665R4100			
24 V AC 115 V AC 230 V AC	Overvoltage protection		CR-U 71 CR-U 71A CR-U 81	1SVR405666R0000 1SVR405666R1000 1SVR405666R2000	10	0.007 (0.015)	
24-240 V AC/DC		Multifunction time module	pluggable onto CR-U2S and CR-U3S	CR-U T	1SVR405667R0000	10	0.014 (0.031)



CR-U...



CR-U T

Connection diagrams

All CR-U modules can be plugged onto sockets CR-U2S and CR-U3S.

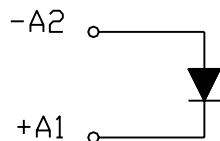

CR-U 21

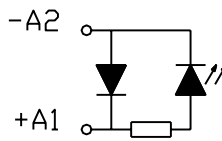

CR-U 41, CR-U 41B, CR-U 41C, CR-U 41V, CR-U 41BV, CR-U 41CV

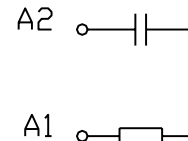

CR-U 51B, CR-U 51C CR-U 51D,

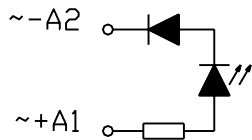

CR-U 61, CR-U 61E, CR-U 91, CR-U 61V, CR-U 61EV, CR-U 91V

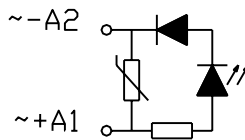

CR-U 61C, CR-U 61D, CR-U 91C, CR-U 61CV, CR-U 61DV CR-U 91CV

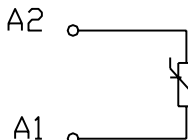

CR-U 71, CR-U 81 CR-U 71A,

Pluggable interface relays

Technical data

Interface relays
CR Range

6

Input circuit - coil data

CR-P range



	Rated control supply voltage U_s	Rated frequency	Make voltage (at 20 °C)	Maximum voltage (at 55 °C)	Break voltage	Rated power	Coil resistance (at 20 °C)	Tolerance of coil resistance
DC coils	12 V DC	-	8.4 V DC	30.6 V DC	M 0.1 U_s	0.4-0.48 W	360 q	w 10%
	24 V DC	-	16.8 V DC	61.2 V DC	M 0.1 U_s	0.4-0.48 W	1440 q	w 10%
	48 V DC	-	33.6 V DC	122.4 V DC	M 0.1 U_s	0.4-0.48 W	5700 q	w 10%
	110 V DC	-	77 V DC	280 V DC	M 0.1 U_s	0.4-0.48 W	25200 q	w 10%
AC coils	24 V AC	50 / 60 Hz	19.2 V AC	28.8 V AC	M 0.15 U_s	0.75 VA	400 q	w 10%
	48 V AC	50 / 60 Hz	38.4 V AC	57.6 V AC	M 0.15 U_s	0.75 VA	1550 q	w 10%
	110 V AC	50 / 60 Hz	88 V AC	132 V AC	M 0.15 U_s	0.75 VA	8900 q	w 10%
	120 V AC	50 / 60 Hz	96 V AC	144 V AC	M 0.15 U_s	0.75 VA	10200 q	w 10%
	230 V AC	50 / 60 Hz	184 V AC	276 V AC	M 0.15 U_s	0.75 VA	38500 q	w 10%

CR-M range



	Rated control supply voltage U_s	Rated frequency	Make voltage (at 20 °C)	Maximum voltage (at 55 °C)	Break voltage	Rated power	Coil resistance (at 20 °C)	Tolerance of coil resistance
DC coils	12 V DC	-	9.6 V DC	13.2 V DC	M 0.1 U_s	0.9 W	160 q	w 10%
	24 V DC	-	19.2 DC	26.4 V DC	M 0.1 U_s	0.9 W	640 q	w 10%
	48 V DC	-	38.4 V DC	52.8 V DC	M 0.1 U_s	0.9 W	2600 q	w 10%
	60 V DC	-	48.0 V DC	66.0 V DC	M 0.1 U_s	0.9 W	4000 q	w 10%
	110 V DC	-	88 V DC	121 V DC	M 0.1 U_s	0.9 W	13600 q	w 10%
	125 V DC	-	100 V DC	137,5 V DC	M 0.1 U_s	0.9 W	16000 q	w 10%
	220 V DC	-	176 V DC	242 V DC	M 0.1 U_s	0.9 W	54000 q	w 10%
AC coils	24 V AC	50 / 60 Hz	19.2 V AC	26.4 V AC	M 0.2 U_s	1.6 VA	158 q	w 10%
	48 V AC	50 / 60 Hz	38.4 V AC	52.8 V AC	M 0.2 U_s	1.6 VA	640 q	w 10%
	60 V AC	50 / 60 Hz	48.0 V AC	66.0 V AC	M 0.2 U_s	1.6 VA	930 q	w 10%
	110 V AC	50 / 60 Hz	88 V AC	121 V AC	M 0.2 U_s	1.6 VA	3450 q	w 10%
	120 V AC	50 / 60 Hz	96 V AC	132 V AC	M 0.2 U_s	1.6 VA	3770 q	w 10%
	230 V AC	50 / 60 Hz	184 V AC	253 V AC	M 0.2 U_s	1.6 VA	16100 q	w 10%

CR-U range



	Rated control supply voltage U_s	Rated frequency	Make voltage (at 20 °C)	Maximum voltage (at 55 °C)	Break voltage	Rated power	Coil resistance (at 20 °C)	Tolerance of coil resistance
DC coils	12 V DC	-	9.6 V DC	13.2 V DC	M 0.1 U_s	1.5 W	110 q	w 10 %
	24 V DC	-	19.2 V DC	26.4 V DC	M 0.1 U_s	1.5 W	430 q	w 10 %
	48 V DC	-	38.4 V DC	52.8 V DC	M 0.1 U_s	1.5 W	1750 q	w 10 %
	110 V DC	-	88.0 V DC	121.0 V DC	M 0.1 U_s	1.5 W	9200 q	w 10 %
	125 V DC	-	96.0 V DC	132.0 V DC	M 0.1 U_s	1.5 W	11000 q	w 10 %
	220 V DC	-	176.0 V DC	242.0 V DC	M 0.1 U_s	1.5 W	37000 q	w 10 %
	AC coils	24 V AC	50 / 60 Hz	19.2 V AC	26.4 V AC	M 0.15 U_s	2.8 VA (50 Hz) 2.5 VA (60 Hz)	75 q
48 V AC		50 / 60 Hz	38.4 V AC	52.8 V AC	M 0.15 U_s	2.8 VA (50 Hz) 2.5 VA (60 Hz)	305 q	w 10 %
60 V AC		50 / 60 Hz	48.0 V AC	66.0 V AC	M 0.15 U_s	2.8 VA (50 Hz) 2.5 VA (60 Hz)	475 q	w 10 %
110 V AC		50 / 60 Hz	88.0 V AC	121.0 V AC	M 0.15 U_s	2.8 VA (50 Hz) 2.5 VA (60 Hz)	1700 q	w 10 %
120 V AC		50 / 60 Hz	96.0 V AC	132.0 V AC	M 0.15 U_s	2.8 VA (50 Hz) 2.5 VA (60 Hz)	1910 q	w 10 %
230 V AC		50 / 60 Hz	184.0 V AC	253.0 V AC	M 0.15 U_s	2.8 VA (50 Hz) 2.5 VA (60 Hz)	7080 q	w 10 %

Pluggable interface relays

Technical data

6

Type	CR-P...1	CR-P...2	CR-M...2	CR-M...3	CR-M...4	CR-U...2	CR-U...3
Output circuit(s)	11-12/14	11-12/14 21-22/24	11-12/14 21-22/24	11-12/14 21-22/24 31-32/34	11-12/14 21-22/24 31-32/34 41-42/44	11-12/14 31-32/34	11-12/14 21-22/24 31-32/34
Kind of output	Relay, 1 c/o	Relay, 2 c/o	Relay, 2 c/o	Relay, 3 c/o	Relay, 4 c/o	Relay, 2 c/o	Relay, 3 c/o
Contact material	AgNi	AgNi AgNi/Au 5 µm	AgNi	AgNi	AgNi AgNi/Au 5 µm		AgNi
Rated operational voltage U _e (VDE 0110, IEC 60947-1)				250 V			
Minimum switching voltage				5 V			
Maximum switching voltage	DC	300 V DC		250 V DC			
	AC	400 V AC		250 V AC			
Minimum switching current	5 mA (AgNi), 2 mA (AgNi/Au)						
Rated free air thermal current I _{th}	16 A	8 A	12 A	10 A	6 A	10 A	
Rated operational current (IEC 60947-5-1)	AC12 (resistive) 230 V	16 A	8 A	12 A	10 A	6 A	10 A
	AC15 (inductive) 230 V	1.5 A	1 A	1.5 A	1.5 A	1 A	1.5 A
	DC12 (resistive) 24 V	16 A	8 A	12 A	10 A	6 A	10 A
	DC13 (inductive) 24 V	2 A	2 A	8 A	8 A	6 A	2 A
AC rating (UL 508)	Utilization category (Control Circuit Rating Code)					-	B 300
	max. rated operational voltage					-	300 V AC
	max. continuous thermal current at B 300					-	5 A
	max. making / breaking apparent power at B 300					-	3600/360 VA
	Utilization category General Purpose (single phase)					-	10 A, 250 V AC
	Utilization category (Resistive)	16 A, 250 V AC	8 A, 250 V AC	10 A, 250 V AC 12 A, 150 V AC	6 A, 250 V AC 10 A, 150 V AC	6 A, 250 V AC 10 A, 150 V AC	10 A, 250 V AC
Minimum switching power	0.3 W (AgNi), 0.1 W (AgNi/Au)						0.3 W
Maximum switching power	AC-1	4000 VA	2000 VA	3000 VA	2500 VA	1500 VA	2500 VA
Contact resistance	≤ 100 mΩ			≤ 100 mΩ			
Maximum switching capacity	rated load AC-1	600 switching cycles/h		1200 switching cycles/h			
	without load	72000 switching cycles/h		18000 switching cycles/h			12000 switching cycles/h
Mechanical lifetime	> 3 × 10 ⁷ switching cycles			> 2 × 10 ⁷ switching cycles			
Electrical lifetime	AC1 (resistive)	> 10 ⁵ switching cycles		> 10 ⁵ switching cycles			> 10 ⁵ switching cycles
		(16 A, 250 V) (8 A, 250 V)	(12 A, 250 V) (10 A, 250 V) (6 A, 250 V)	(10 A, 250 V) (6 A, 250 V)	(10 A, 250 V)		
	cos φ	see reduction factor F					
Response time	typ. 7 ms		typ. 13 ms (DC), 10 ms (AC)			typ. 18 ms (DC), 12 ms (AC)	
Release time	typ. 3 ms		typ. 3 ms (DC), 8 ms (AC)			typ. 7 ms (DC), 10 ms (AC)	
Isolation data							
Rated insulation voltage	400 V AC			250 V AC			
Insulation class	C250 / B400			C250 / B250		C250	
Rated impulse withstand voltage U _{imp}	between coil and contacts	5 kV AC			2.5 kV AC		
	between open contacts	1 kV AC			1.5 kV AC		
	between c/o contacts	2.5 kV AC			2.5 kV AC	2 kV AC	2 kV AC
Clearance	between coil and contacts	≥ 10 mm		≥ 2.5 mm	≥ 1.6 mm	≥ 3 mm	
Creepage distance	between coil and contacts	≥ 10 mm		≥ 4 mm	≥ 3.2 mm	≥ 4.2 mm	
Overvoltage category	III			III	II	III	
Pollution degree	3			3	2	3	
General data							
Dimensions (W x H x D) when mounted	12.7 x 29 x 15.7 mm			21.2 x 27.5 x 35.6 mm		35 x 35 x 54.4 mm	
Weight	14 g (0.031 lb)			35 g (0.077 lb)		83 g (0.18 lb)	
Mounting	on socket (see accessories)						
Mounting position	any						
Degree of protection	IP 67			IP 40			
Electrical connection							
Connection	by socket						

Pluggable interface relays

Technical data, load limit curves

Interface relays
CR Range

Type		CR-P...1	CR-P...2	CR-M...2	CR-M...3	CR-M...4	CR-U...2	CR-U...3
Environmental data								
Ambient temperature range	operation DC	-40 ... +85 °C			-40 ... +70 °C			
	operation AC	-40 ... +70 °C			-40 ... +55 °C			
	storage	-40 ... +85 °C						
Vibration resistance 10-150 Hz	n/o contact	10 g			5 g		5 g	
	n/c contact	10 g	5 g		5 g		5 g	
Shock resistance	n/o contact	30 g	20 g		10 g		10 g	
	n/c contact	30 g	20 g		5 g		10 g	
Standards								
Product standard		EN 61810-1, EN 60255-23 IEC 60664-1		EN 60810-1, EN 60255-23 IEC 61810-7			EN 60255-1-00	
Low Voltage Directive		73/23/EEC						

6

Load limit curves - Maximum switching power at resistive DC load

CR-P with 1 c/o contact

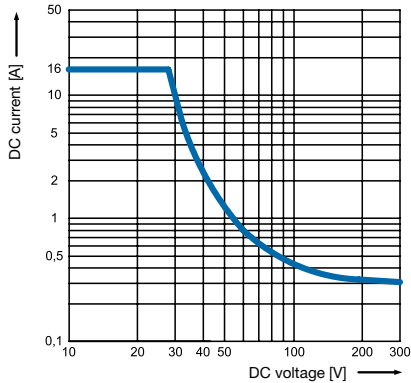

CR-P with 2 c/o contacts

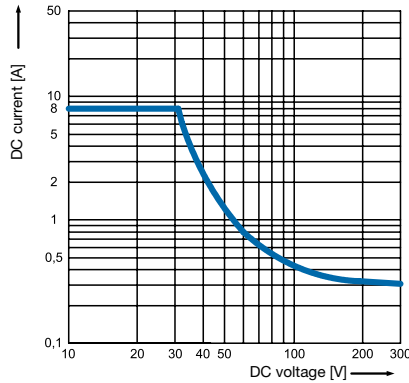

CR-U with 2 and 3 c/o contacts

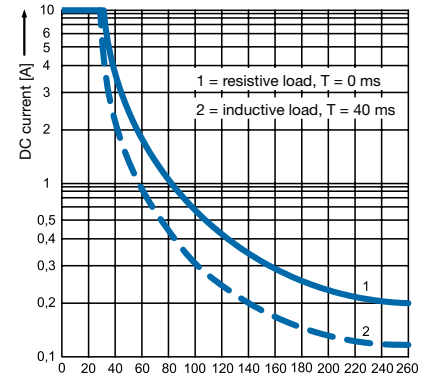

CR-M with 2 c/o contacts

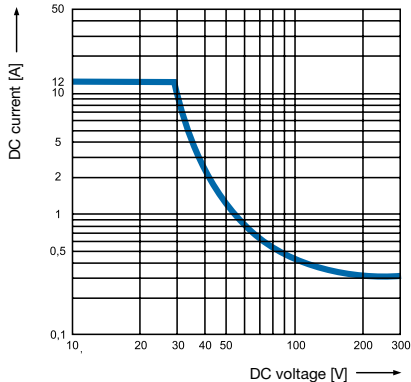

CR-M with 3 c/o contacts

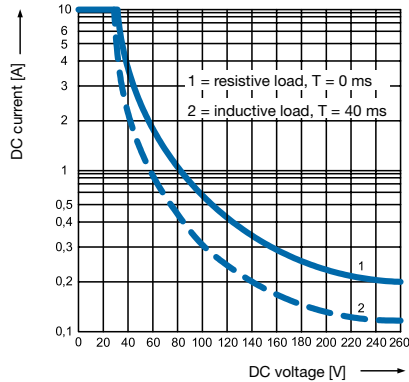

CR-M with 4 c/o contacts

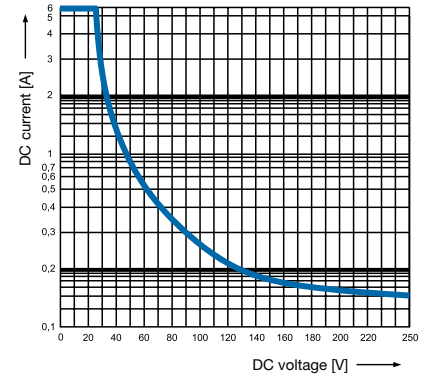

Pluggable interface relays

Load limit curves

Load limit curves - Electrical lifetime at resistive AC load

6

CR-P with 1 c/o contact

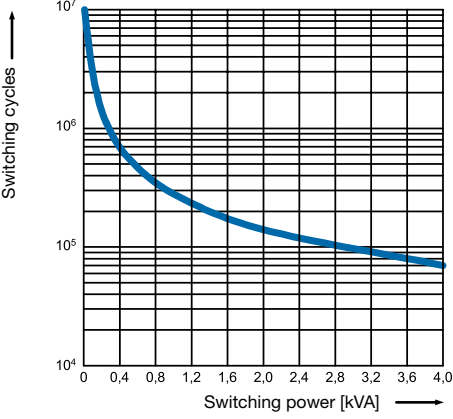

CR-P with 2 c/o contacts

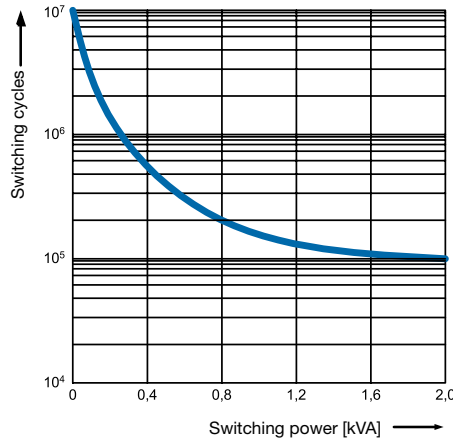

CR-U with 2 and 3 c/o contacts

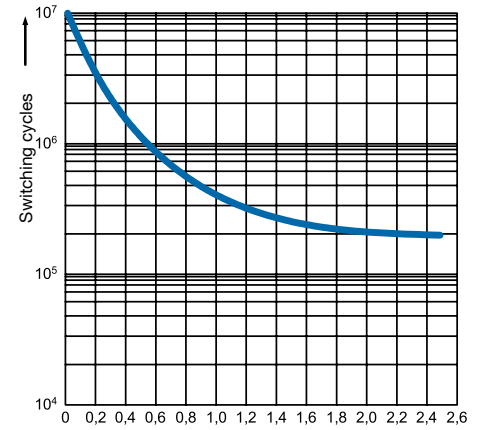

CR-M with 2 c/o contacts

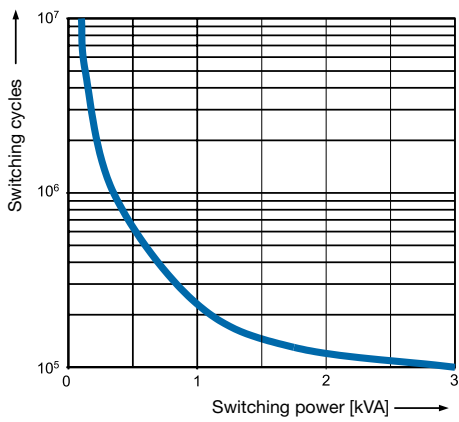

CR-M with 3 c/o contacts

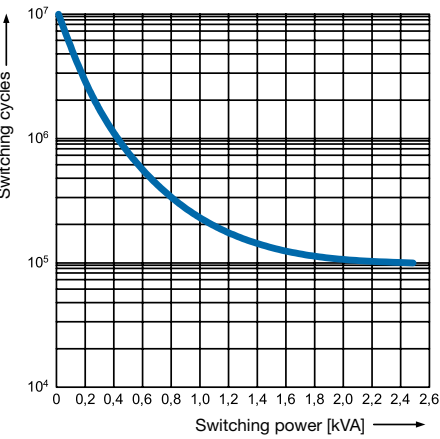

CR-M with 4 c/o contacts

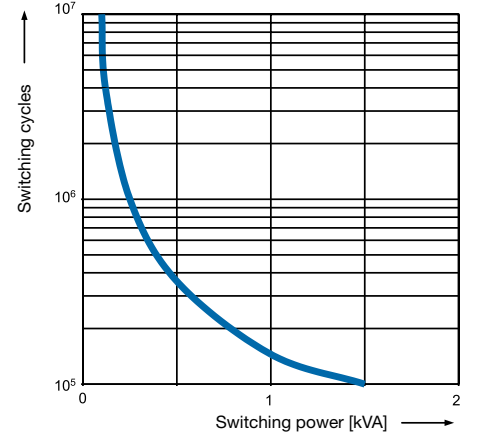

Reduction factor F at inductive AC load

CR-P

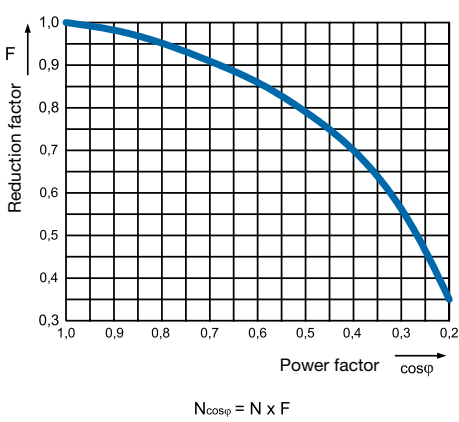

CR-M

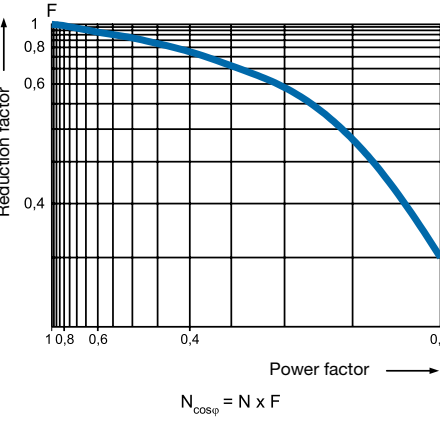

CR-U

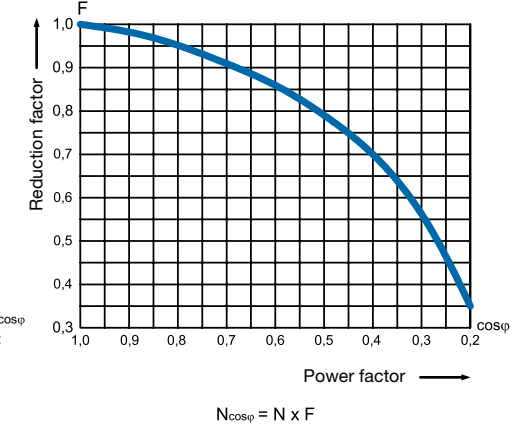

Pluggable interface relays

Connection diagrams

Interface relays
CR Range

Connection diagrams

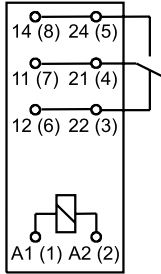

CR-P with 1 c/o contact

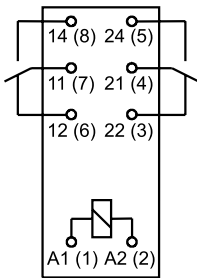

CR-P with 2 c/o contacts

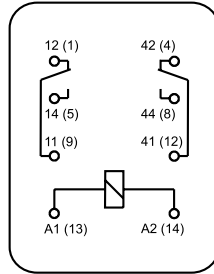

CR-M with 2 c/o contacts

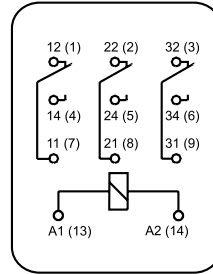

CR-M with 3 c/o contacts

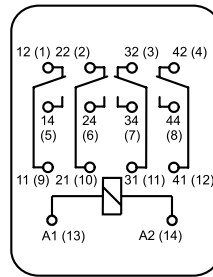

CR-M with 4 c/o contacts

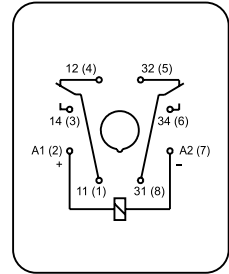

CR-U with 2 c/o contacts

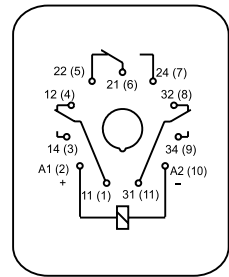

CR-U with 3 c/o contacts

Dimensional drawings

Dimensions in mm

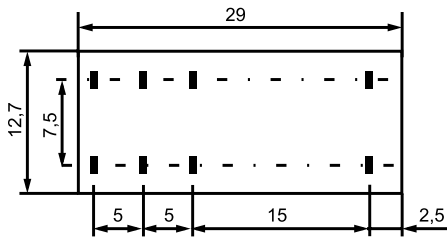

CR-P

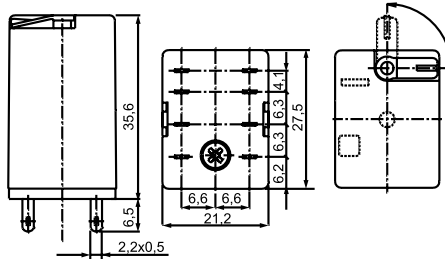

CR-M with 2 c/o contacts

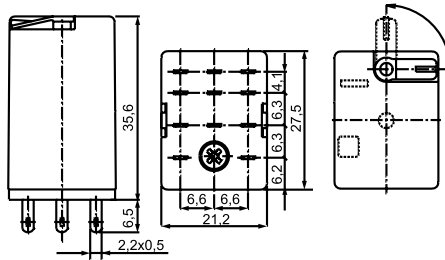

CR-M with 3 c/o contacts

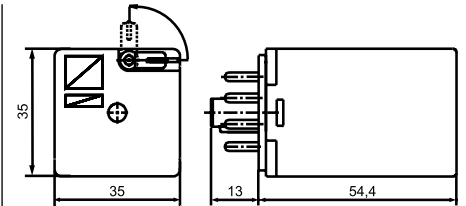
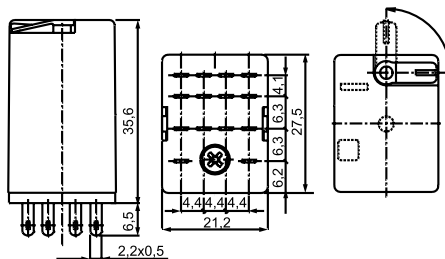

CR-U with 2 c/o contacts

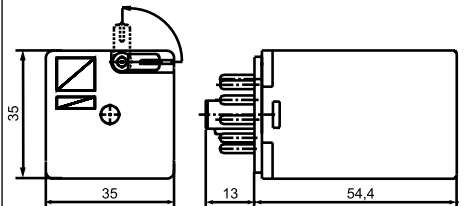

CR-U with 3 c/o contacts

Pluggable interface relays

Approximate dimensions

Dimensional drawings

Sockets for screw connection

6

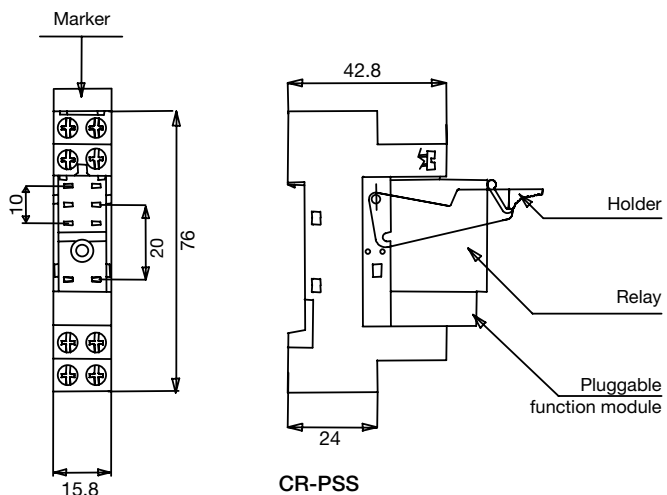
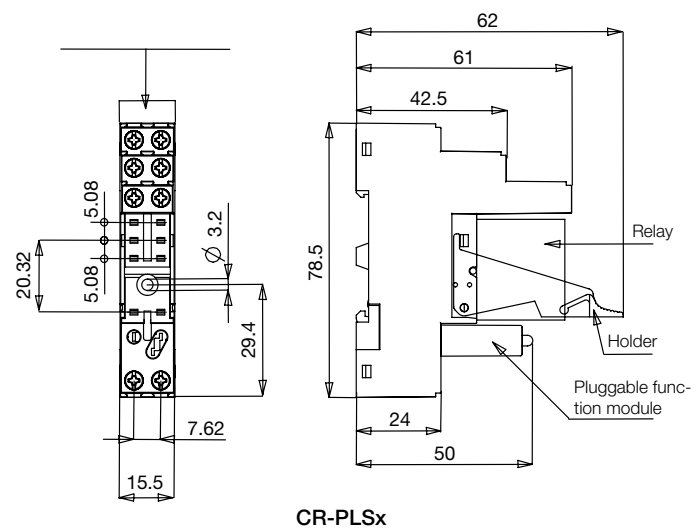
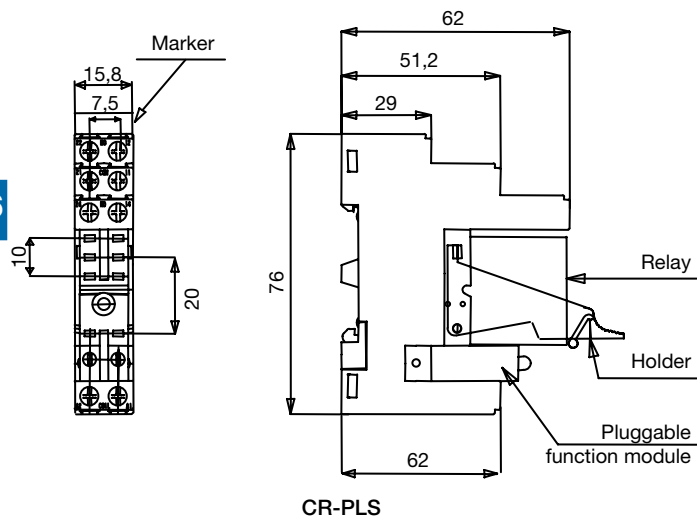

Dimensions in mm

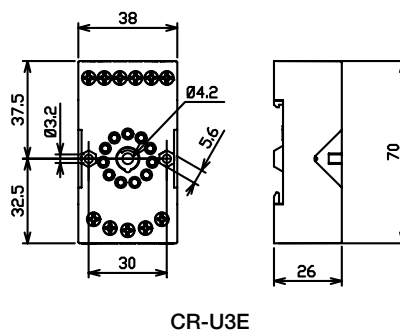
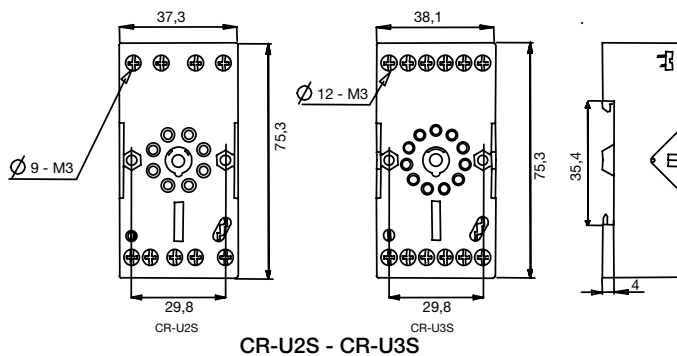
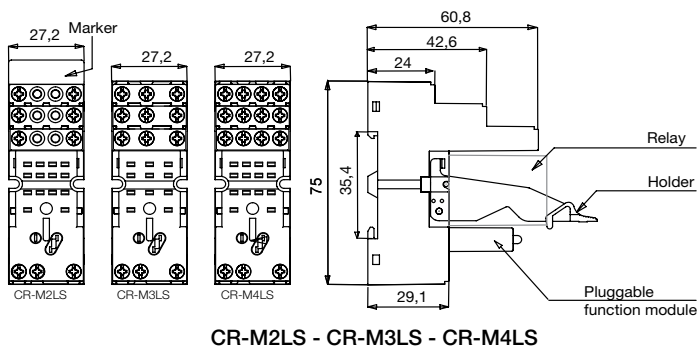
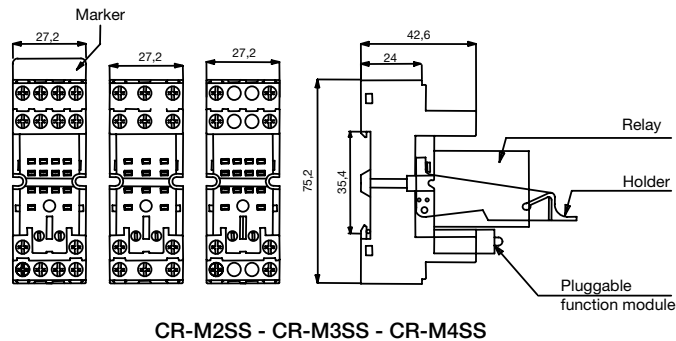

Pluggable interface relays

Approximate dimensions

Interface relays
CR Range

Dimensional drawings

Dimensions in mm

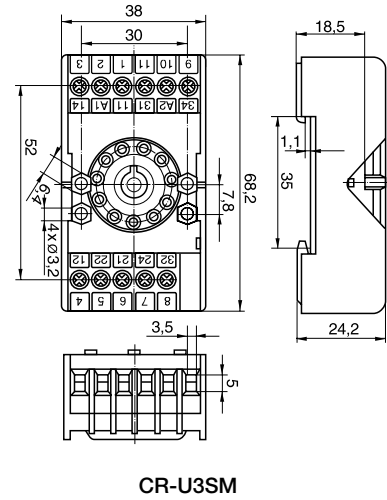
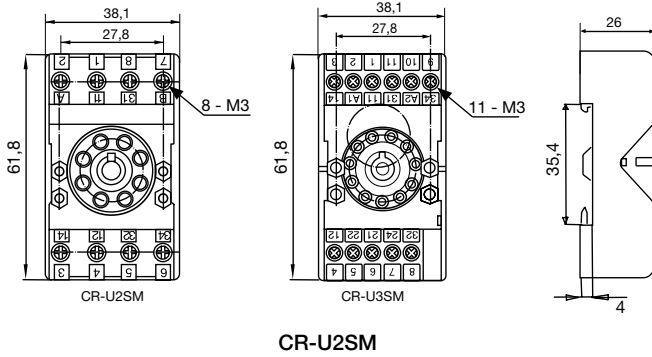

Sockets for spring connection

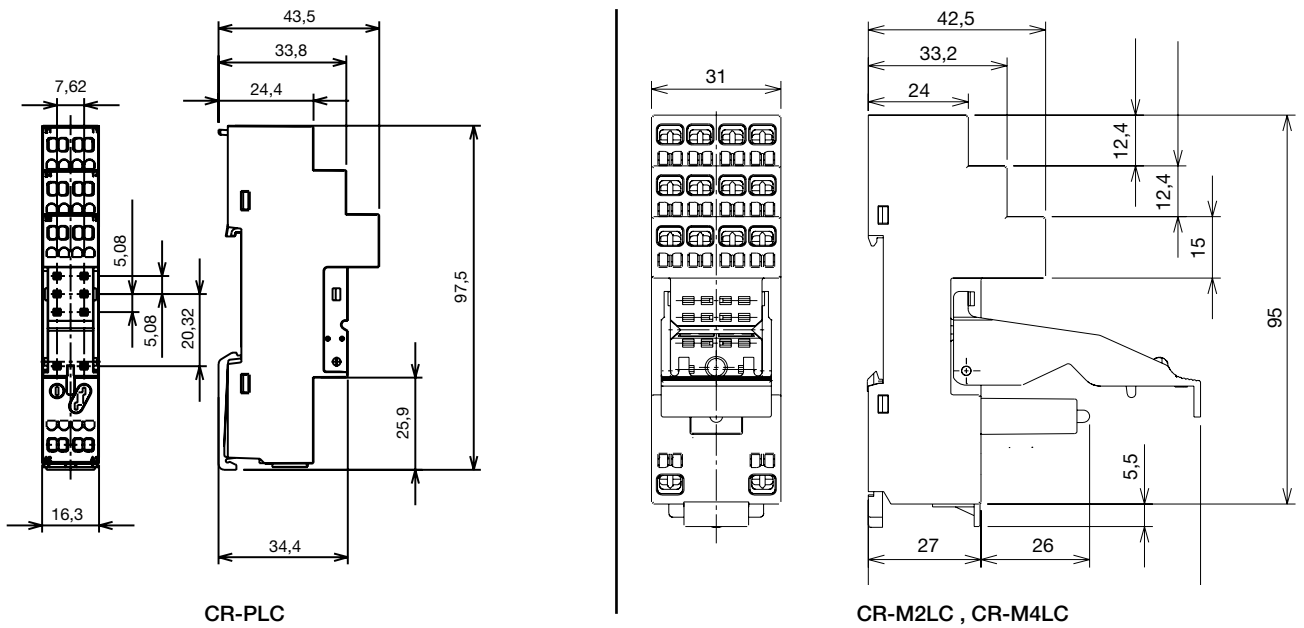

Jumper

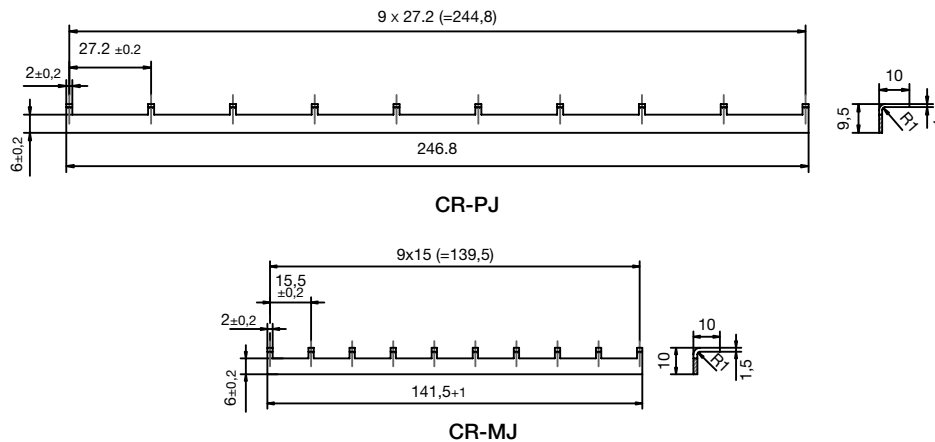

Notes



Interface relays
R600, R500

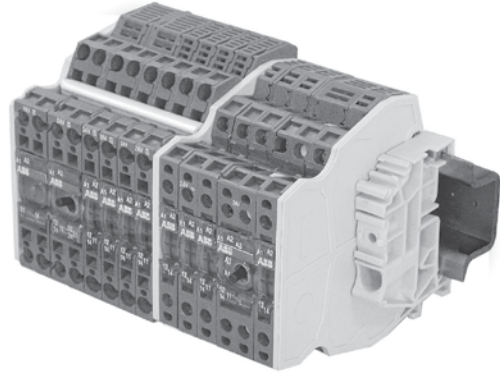

R600 & R500 Interface relays

Interface relays, R600, R500

Benefits and advantages

6



R600 series

Standard range in screw clamp or spring clamp versions

- Spacing : 6 mm
- Wire size : 2.5 mm² (4 mm² solid wire)
- Contact type : 1 NO, 1 NC, 1 SPDT, 1 DPDT from 1 mA to 8 A / 250 V
- Transistor : 100 mA
MOS : 1 A to 5 A
Triac : 1 A to 2 A

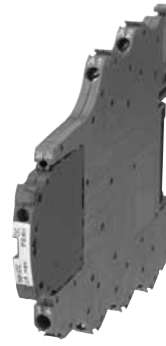

R500 series

Standard range with pluggable functions

- Spacing : 5.08 mm (the smallest in the market)
- Wire size : 2.5 mm² (4 mm² solid)
- Contact type : 1 SPDT from 10 mA to 6 A / 250 V
- Transistor : 30 mA to 100 mA
MOS : 1 A to 2 A
Triac : 1 A

In today's automation systems, PLCs are the core of industry. They link sensors and actuators to the process, which are connected to the PLC via conventional wires.

However these PLCs are not completely isolated from the industrial environment, hence voltage spikes and transient currents can affect their operating functions. And additionally, their application range is often limited to 24 VDC / 100 mA.



So, with the aim to adapt application voltage and/or current and provide as well the appropriate galvanic isolation to the PLC, it is recommended to install the correct interface to provide both voltage-current level adaptation and isolation protection.

This interfacing is possible thanks to ABB's relays and optocouplers ranges, which offer wide adaptation in both voltage (from 5 to 400 V) and current (from 10-7 to 16 A) as well as high isolation between input and output from 2 to 4 KV.

Interface relays, R600, R500

Type designators

Interface relays
R600 & R500 Range

SERIES	CODE	NB OF RELAYS	CONTACT TYPE	NB OF CONTACTS PER RELAY	PARTICULARITIES			
R 600 	<table border="1"><tr><td>R</td><td>B</td></tr></table>	R	B	<input type="checkbox"/>	<input type="checkbox"/>	<input type="checkbox"/>	<input type="checkbox"/>	
R	B							
R 600 	<table border="1"><tr><td>R</td><td>B</td><td>R</td></tr></table>	R	B	R	<input type="checkbox"/>	<input type="checkbox"/>	<input type="checkbox"/>	<input type="checkbox"/>
R	B	R						
R 500	<table border="1"><tr><td>D</td><td>2,5/5</td><td>R</td></tr></table>	D	2,5/5	R	<input type="checkbox"/>	<input type="checkbox"/>	<input type="checkbox"/>	<input type="checkbox"/>
D	2,5/5	R						
		<input type="checkbox"/>	<input type="checkbox"/>	<input type="checkbox"/>	<input type="checkbox"/>			
		↓	↓	↓	↓			
		1	0	1	None			
		2	1	2	A			
			2		B			
			3		C			
					N			
					P			
					R			
					V			
					I			

Description of contact types

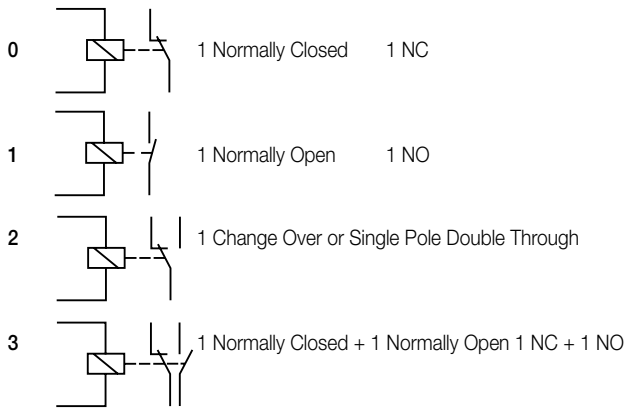

Features

- None Input voltage DC
- A Input voltage AC/DC
- B Input voltage AC
- C 2 wire sensor compatibility

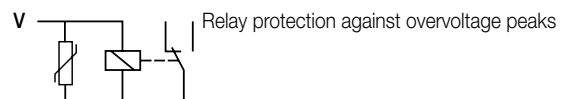
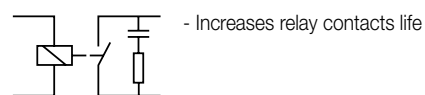
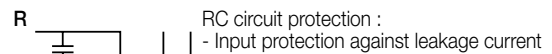
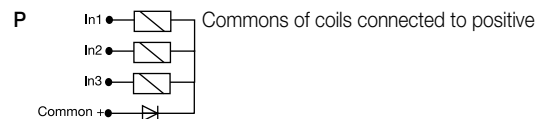
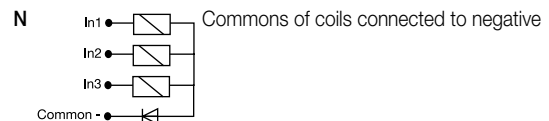
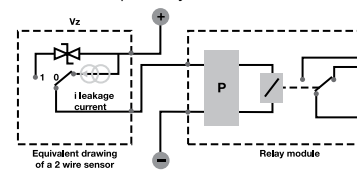

I Switch to force the coil for maintenance and/or installation purposes

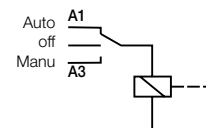

Color coding for relays

Color	Current level in contacts	Switching current	Switching voltage	Switching load power
green	Very low level	10 ⁻⁷ to 5 A	10 ⁻³ to 250 V	10 ⁻¹⁰ to 2000 VA 10 ⁻¹⁰ to 200 W
grey	Low level	1 mA to 8 A	5 to 250 V	0,05 to 1500 VA 0,05 to 192 W
blue	High level	10 mA to 16 A	12 to 380 V	0,6 to 4000 VA 0,6 to 240 W

Interface relays, R600 Selection

6

	Reference code	Catalog number
	RB 121-5VDC	1SNA645034R2300
	RB 121-5VDC	1SNA645036R2500
	RBR 121-5VDC	1SNA645534R2500
	RBR 121-5VDC	1SNA645536R2700
	RB 121-12VDC	1SNA645069R0000
	RB 121-12VDC	1SNA645037R2600
	RBR 121-12VDC	1SNA645569R0000
	RBR 121-12VDC	1SNA645537R2000
	RB 101AR-24VAC/DC	1SNA645019R0400
	RBR 101AR-24VAC/DC	1SNA645519R0600
	RB 111A-24VAC/DC	1SNA645014R2700
	RB 111AI-24VAC/DC	1SNA645063 R0000
	RB 111AR-24VAC/DC	1SNA645018R0300
	RBR 111A-24VAC/DC	1SNA645514R2100
	RBR 111AI-24VAC/DC	1SNA645563R0200
	RBR 111AR-24VAC/DC	1SNA645518R0500
	RB 121-24VDC	1SNA645064R0100
	RB 121-24VDC	1SNA645065R0200
	RB 121A-24VAC/DC	1SNA645001R0300
	RB 121A-24VAC/DC	1SNA645005R0700
	RB 121AI-24VAC/DC	1SNA645032R2100
	RB 121AI-24VAC/DC	1SNA645009R1300
	RB 121AI-24VAC/DC	1SNA645033R2200
	RB 121AI-24VAC/DC	1SNA645010R0700
	RBR 121-24VDC	1SNA645564R0300
	RBR 121-24VDC	1SNA645565R0400
	RBR 121A-24VAC/DC	1SNA645501R0500
	RBR 121A-24VAC/DC	1SNA645505R0100
	RBR 121AI-24VAC/DC	1SNA645532R2300
	RBR 121AI-24VAC/DC	1SNA645509R1500
	RBR 121AI-24VAC/DC	1SNA645533R2400
	RBR 121AI-24VAC/DC	1SNA645510R0100

Input voltage																													
5 V DC	■	■	■	■																									
12 V DC					■	■	■	■																					
24 V DC									■	■	■	■	■	■	■	■	■	■	■	■	■	■	■	■	■	■	■	■	■
48 - 60 V DC																													
110 - 115 V DC																													
230 V DC																													
60 - 230 V DC																													
24 V AC									■	■	■	■	■	■	■	■	■	■	■	■	■	■	■	■	■	■	■	■	■
48 - 60 V AC																													
115 V AC																													
230 V AC																													
60 - 230 V AC																													

Output rating																													
10 mA - 6 A	■	■	■	■	■	■	■	■	■	■	■	■	■	■	■	■	■	■	■	■	■	■	■	■	■	■	■	■	■
1 mA - 6 A		■	■	■	■	■	■	■																					
1 mA - 8 A																													

Output contacts																													
c/o	1	1	1	1	1	1	1	1																					
n/o																													
n/c									1	1																			

Terminal type																													
Screw	■	■		■	■		■		■	■	■	■																	
Spring		■	■			■	■	■		■																			

Interface relays, R600

Benefits and advantages

Characteristics

Standard range in screw clamp or spring clamp versions

- Spacing : 6 mm
- Wire size : 2.5 mm² (4 mm² solid wire)
- Contact type : 1 NO, 1 NC, 1 SPDT, 1 DPDT from 1 mA to 8 A / 250 V
- Transistor : 100 mA
 - MOS : 1 A to 5 A
 - Triac : 1 A to 2 A

6

Benefits

Increased contact life

The contacts are protected by built in RC-circuits which result in increased contact life.

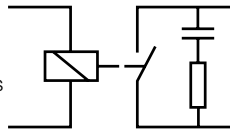

Variety of connections

R600 relays and optocouplers are available with both screw terminals or spring terminals.

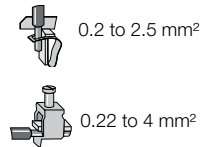

Space saving

With a width of only 6 mm or 12 mm the compact design saves space in each cabinet.

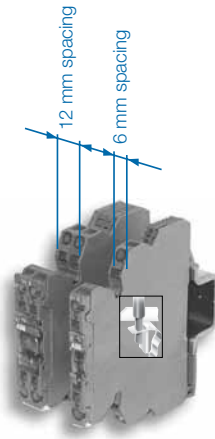

Functioning status

Functioning display through a green LED.



Only one part number AC/DC

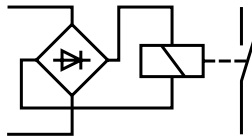

Measurement & Test

Holes for holding DIA. 2 mm test plugs to simplify any measure or test.



Excellent adaptation and conversion of digital signals

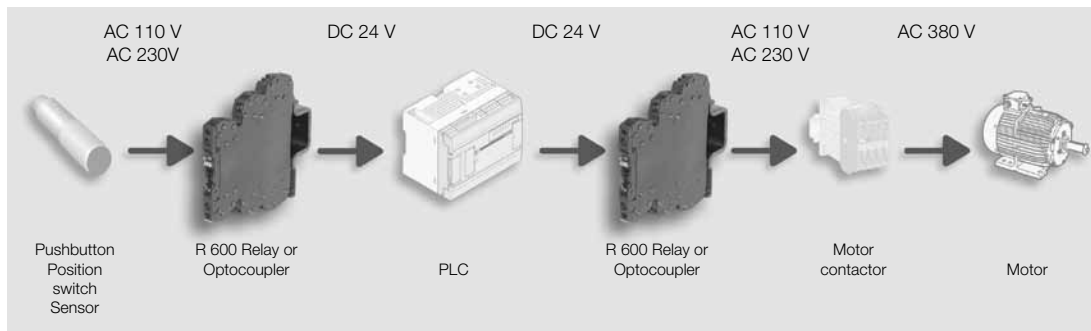

Interface relays, R600

Ordering details

Interface relays
R600 & R500 Range



R600

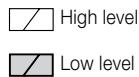

R600 Relay		Reference code	Catalog number	Pkg qty	Weight (1 pce) kg (lb)
☑ Relay module 1 NO high level 6 mm spacing		RB 111 A-24VAC/DC	1SNA645014R2700	10	0.02 (0.44)
		RB 111 A-48-60VAC/DC	1SNA645015R2000		
		RB 111 A-115VAC/DC	1SNA645016R2100		
		RB 111 A-230VAC/DC	1SNA645017R2200		
☑ Relay mod. 1 NO high level w/safety switch 6 mm spacing		RB 111 AI-24VAC/DC	1SNA645063R0000		
☑ Relay mod. 1 NO/NC high level w/contact protection 12 mm spacing		RB 111 AR-24VAC/DC	1SNA645018R0300	5	0.03 (0.44)
		RB 101 AR-24VAC/DC	1SNA645019R0400		
☑ Relay module 1 NO high level 6 mm spacing		RBR 111 A-24VAC/DC	1SNA645514R2100	10	0.02 (0.44)
		RBR 111 A-48-60VAC/DC	1SNA645515R2200		
		RBR 111 A-115VAC/DC	1SNA645516R2300		
☑ Relay mod. 1 NO high level w/safety switch 6 mm spacing		RBR 111 AI-24VAC/DC	1SNA645563R0200		
		RBR 111 AR-24VAC/DC	1SNA645518R0500	5	0.03 (0.44)
☑ Relay mod. 1 NO/NC high level w/contact protection 12 mm spacing		RBR 101 AR-24VAC/DC	1SNA645519R0600		
☑ Relay module 1 SPDT high level		RB 121-5VDC	1SNA645034R2300	10	0.02 (0.44)
		RB 121-12VDC	1SNA645069R0100		
		RB 121-24VDC	1SNA645064R0100		
		RB 121 A-24VAC/DC	1SNA645001R0300		
		RB 121 A-48-60VAC/DC	1SNA645002R0400		
		RB 121 A-115VAC/DC	1SNA645003R0500		
☑ Relay module 1 SPDT high level		RB 121 A-230VAC/DC	1SNA645004R0400	10	0.02 (0.44)
		RB 121-5VDC	1SNA645534R2500		
		RB 121-12VDC	1SNA645569R0000		
		RB 121-24VDC	1SNA645564R0300		
		RB 121 A-24VAC/DC	1SNA645501R0500		
		RB 121 A-48-60VAC/DC	1SNA645502R0600		
☑ Relay module 1 SPDT low level		RB 121 A-115VAC/DC	1SNA645503R0700	10	0.02 (0.44)
		RB 121 A-230VAC/DC	1SNA645504R0000		
		RB 121-5VDC	1SNA645036R2500		
		RB 121-12VDC	1SNA645037R2600		
		RB 121-24VDC	1SNA645065R0200		
		RB 121 A-24VAC/DC	1SNA645005R0700		
☑ Relay module 1 SPDT low level		RB 121 A-48-60VAC/DC	1SNA645006R0000	10	0.02 (0.44)
		RB 121 A-115VAC/DC	1SNA645007R0100		
		RB 121 A-230VAC/DC	1SNA645008R1200		
		RB 121-5VDC	1SNA645536R2700		
		RB 121-12VDC	1SNA645537R2000		
		RB 121-24VDC	1SNA645565R0400		
☑ Relay module 1 SPDT low level		RB 121 A-24VAC/DC	1SNA645505R0100	10	0.02 (0.44)
		RB 121 A-48-60VAC/DC	1SNA645506R0200		
		RB 121 A-115VAC/DC	1SNA645507R0300		
		RB 121 A-230VAC/DC	1SNA645508R1400		

Accessories R600

	Reference code	Catalog number	Pkg qty	Weight (1 pce) kg (lb)
End section	BADH V0	011690027	50	
	BADL V0	039990302	50	
Separator end section	BAM2 V0	039996701	50	
Divisible shunt 10 poles	SC 612	1SNA290474R0200	10	
Screw clamp distribution block sp. 12 mm	BJ 612-10	1SNA290488R0100	10	
Spring clamp distribution block sp. 12 mm	D4/12-3-3	1SNA645031R2000	5	
Test plug DIA. 2 mm	D4/12-3R-3R	1SNA645531R2200	5	
Marking method	FC2	000786526	10	
	RC65 / RC610	see marking		

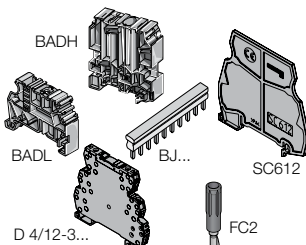

Interface relays, R600

Ordering details

6



R600

- High level
- Low level

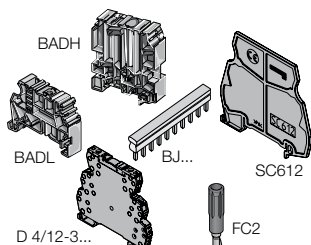

R600 Relay	Reference code	Catalog number	Pkg qty	Weight (1 pce) kg (lb)			
<input type="checkbox"/> Relay mod. 1SPDT high level w/leakage current protec. <input type="checkbox"/> Relay mod. 1SPDT high level w/large coil voltage range <input type="checkbox"/> Relay mod. 1SPDT high level with switch <input type="checkbox"/> Relay mod. 1SPDT high level with safety switch <input checked="" type="checkbox"/> Relay module 1SPDT low level with switch <input checked="" type="checkbox"/> Relay module 1SPDT low level with safety switch <input type="checkbox"/> Relay mod. 1SPDT high level w/leakage current protec. <input type="checkbox"/> Relay mod. 1SPDT high level w/large coil voltage range <input type="checkbox"/> Relay mod. 1SPDT high level with switch <input type="checkbox"/> Relay mod. 1SPDT high level with safety switch <input checked="" type="checkbox"/> Relay module 1SPDT low level with switch <input checked="" type="checkbox"/> Relay module 1SPDT low level with safety switch	<input checked="" type="checkbox"/> RB 121 AR-115VAC/DC <input checked="" type="checkbox"/> RB 121 AR-230VAC/DC	1SNA645046R0700 1SNA645011R2400	5	0.03 (0.066)			
	<input checked="" type="checkbox"/> RB 121 A 60-230VAC/DC	1SNA645020R0100					
	<input checked="" type="checkbox"/> RB 121 AI-24VAC/DC	1SNA645032R2100					
	<input checked="" type="checkbox"/> RB 121 AI-24VAC/DC	1SNA645009R1300					
	<input checked="" type="checkbox"/> RB 121 AI-24VAC/DC	1SNA645033R2200					
	<input checked="" type="checkbox"/> RB 121 AI-24VAC/DC	1SNA645010R0700					
	<input type="checkbox"/> RB 121 AR-115VAC/DC <input type="checkbox"/> RB 121 AR-230VAC/DC	1SNA645546R0100 1SNA645511R2600					
	<input checked="" type="checkbox"/> RB 121 A 60-230VAC/DC	1SNA645520R0300					
	<input type="checkbox"/> RB 121 AI-24VAC/DC	1SNA645532R2300					
	<input type="checkbox"/> RB 121 AI-24VAC/DC	1SNA645509R1500					
	<input checked="" type="checkbox"/> RB 121 AI-24VAC/DC	1SNA645533R2400					
	<input checked="" type="checkbox"/> RB 121 AI-24VAC/DC	1SNA645510R0100					
	<input checked="" type="checkbox"/> Relay module 1 DPDT low level <input checked="" type="checkbox"/> Relay module 1 DPDT low level	<input checked="" type="checkbox"/> RB 122 A-24VAC/DC <input checked="" type="checkbox"/> RB 122 A-48-60VAC/DC <input checked="" type="checkbox"/> RB 122 A-115VAC/DC <input checked="" type="checkbox"/> RB 122 A-230VAC/DC			1SNA645012R2500 1SNA645040R1500 1SNA645041R0200 1SNA645013R2600	5	0.03 (0.066)
		<input checked="" type="checkbox"/> RBR 122 A-24VAC/DC <input checked="" type="checkbox"/> RBR 122 A-48-60VAC/DC <input checked="" type="checkbox"/> RBR 122 A-115VAC/DC <input checked="" type="checkbox"/> RBR 122 A-230VAC/DC			1SNA645512R2700 1SNA645540R1700 1SNA645541R0400 1SNA645513R2000		
Accessories R600		Reference code	Catalog number	Pkg qty	Weight (1 pce) kg (lb)		
End section		BADH V0	011690027	50			
		BADL V0	039990302	50			
Separator end section		BAM2 V0	039996701	50			
		SC 612	1SNA290474R0200	10			
Divisible shunt 10 poles		BJ 612-10	1SNA290488R0100	10			
Screw clamp distribution block sp. 12 mm	D4/12-3-3	1SNA645031R2000	5				
Spring clamp distribution block sp. 12 mm	D4/12-3R-3R	1SNA645531R2200	5				
Test plug DIA. 2 mm	FC2	000786526	10				
Marking method	RC65 / RC610	see marking					

Interface relays, R600

Connection diagrams

Interface relays
R600 & R500 Range

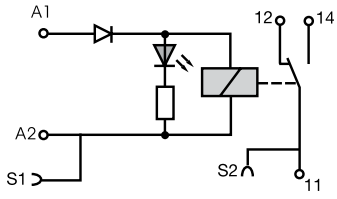

RB...121 - 5-12 V DC

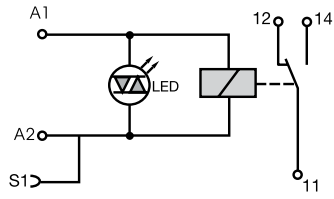

RB...121 - 24 V DC

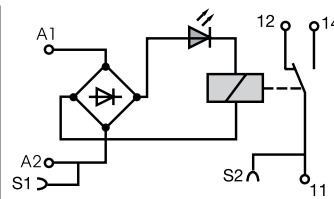

RB...121 A
48-60-115-230 V AC/DC

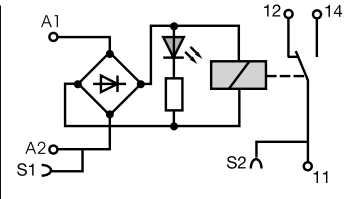

RB...121 A - 24 V AC/DC

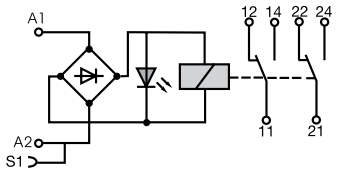

RB...122 A
24-48-60 V AC/DC

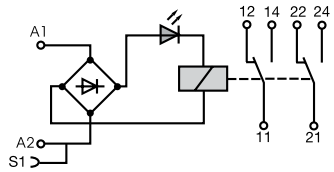

RB...122 A
115-230 V AC/DC

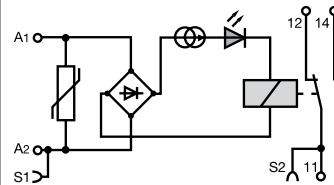

RB...121 A

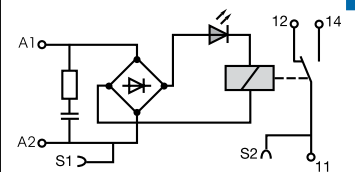

RB...121 AR

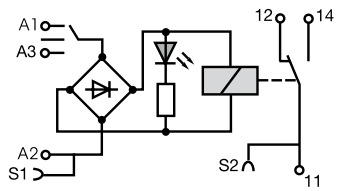

RB...121 AI

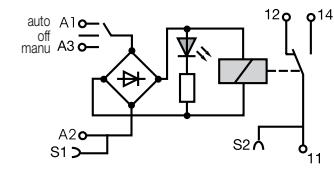

RB...121 AI

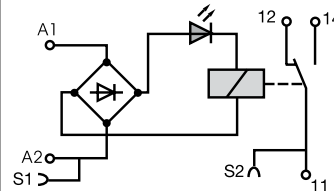

RB...121 A
48-60-115-230 V AC/DC

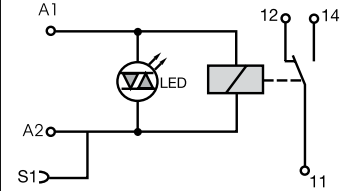

RB...121 - 12-24 V DC

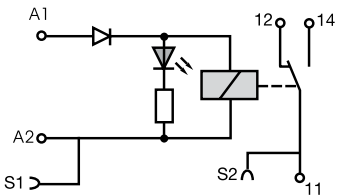

RB...121 - 5 V DC

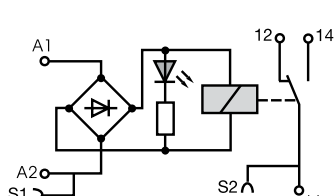

RB...121 A - 24 V AC/DC

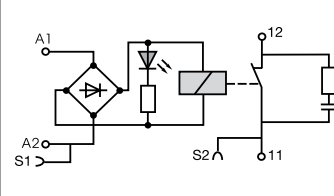

RB...101 AR

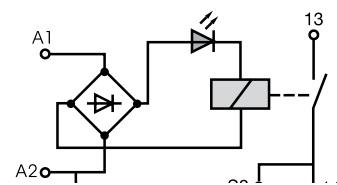

RB...111 A 48-60-115-230 V AC/DC

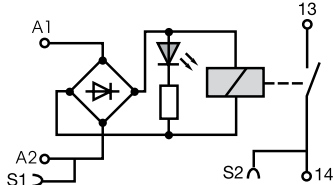

RB...111 A - 24 V AC/DC

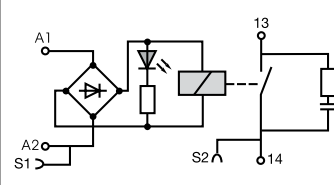

RB...111 AR

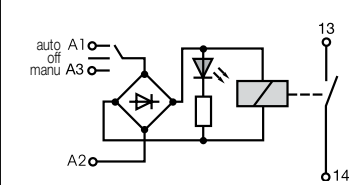

RB...111 AI

Interface relays, R600

Technical information

Technical data

Relay : 1NO or 1NC high level contact 10 mA to 6 A - 6 mm .236" or 12 mm .472" spacing

		RB 111 A				RB 111 AI	RB 111 AR	RB 101 AR	
Relay characteristics coil									
Rated voltage: +20%, -15% on DC ; 10%, -10% on AC		24 VAC/DC	48 VAC/DC	60 VAC/DC	115 VAC/DC	230 VAC/DC ±10% on AC ±10%-15% on DC	24 VAC/DC	24 VAC/DC	24 VAC/DC
Frequency		50/60 Hz							
Power		0.24 W	0.34 W	0.54 W	0.46 W	0.8 W	0.24 W	0.24 W	0.24 W
Rated current		10 mA	7 mA	9 mA	4 mA	3.5 mA	10 mA	10 mA	10 mA
Drop-out voltage at 20°C		4.5 V	8 V	8 V	17 V	27 V	4.5 V	4.5 V	4.5 V
Status device		green LED							
Relay characteristics contact									
Type		1 NO					1 NO + RC		
Voltage switching range min./max.		12 V / 250 VAC							
Current switching range min./max.		10 mA / 6 A							
Load switching range		AC1 min./max.		0.6 VA / 1500 VA (ohmic load)					
		DC1 min./max.		0.6 W / 140 W					
Number of on-load operations		10 ⁵ on AC15							
Number of off-load operations		10 ⁷							
Operation speed		F	5 ms	6 ms	7 ms		5 ms		
		O	8 ms		15 ms		8 ms		
Bounce		1.2 ms							
Insulation coil / contact		4000 V RMS				3800 V RMS			4000 V RMS
Resistance to shock coil / contact		4000 V RMS							
Insulation contact / contact		1000 V RMS							
Ambient temperature		storage		-40 °C to +80 °C					
		operating		-20 °C to +70 °C ¹⁾					
Other characteristics		Screw clamp				Spring clamp			
Body material		grey				UL 94 V0			
Wire size		Solid wire		0.2 - 4 mm ² (24-12 AWG)		0.2-2.5 mm ² (24-12 AWG)			
		Stranded wire		0.22 - 2.5 mm ² (24-12 AWG)					
Rated wire size		2.5 mm ² (12 AWG)							
Wire stripping length		9 mm (0.354 in)							
Recommended screwdriver		3.5 mm (0.137 in)							
Protection		IP20 NEMA7							
Recommended torque		0.4-0.6 Nm (3.5-5.3 lb.in)							
Approvals		UL, (pending), LRS, CE							
Reference standards		CEI 947-7-1 / CEI 947-1 / CEI 1131-2 (in relevant parts) / CEI 60664-1 / CEM : IRC 1000-4-2, 3, 4, 5, 6.							

¹⁾ Over 55°C, blocks have to be mounted on horizontal rail with 10 mm spacing between each block. For vertical rail mounting use temperature is 15°C less decreased.

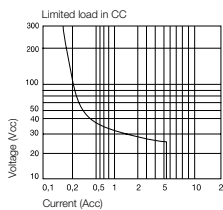

	DC12	AC12	DC13	AC15
24 V	6 A	6 A	1 A	3 A
110/120 V	0.3 A	6 A	0.2 A	3 A
220/230 V	0.2 A	6 A	0.1 A	3 A

Dimensional drawings

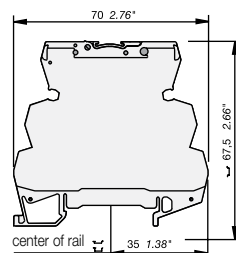

Screw clamp module

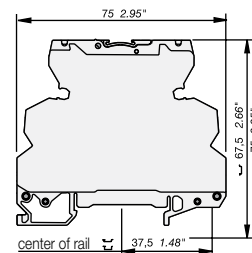

Spring clamp module

Interface relays, R600

Technical information

Interface relays
R600 & R500 Range

Technical data

Relay : 1 SPDT high level contact 10 mA to 6 A - 6 mm .236"

	RB 121			RB 121A				
Relay characteristics coil								
Rated voltage: +20%, -15% on DC ; 10%, -10% on AC	5 V DC	12 V DC	24 V DC	24 V AC/DC	48 V AC/DC	60 V AC/DC	115 V AC/DC	230 V AC/DC ± 10% on AC ± 10%-15% on DC
Frequency	-			50/60 Hz				
Power	0.2 W	0.2 W	0.28 W	0.24 W	0.33 W	0.54 W	0.46 W	0.8 W
Rated current	40 mA	16 mA	12 mA	10 mA	7 mA	9 mA	4 mA	3.5 mA
Drop-out voltage at 20°C	1.2 V	2.2 V	1.2 V	4.5 V	8 V	8 V	17 V	27 V
Status device	green LED							
Relay characteristics contact								
Type	1 SPDT							
Voltage switching range min./max.	12 V / 250 V AC							
Current switching range min./max.	10 mA / 6 A							
Load switching range	0.6 VA / 1500 VA (ohmic load)							
	AC1 min./max.							
	DC1 min./max.	0.6 W / 140 W						
Number of on-load operations	10 ⁵ on AC15							
Number of off-load operations	10 ⁷							
Operation speed	F	5 ms			6 ms		7 ms	
	O	8 ms			15 ms		16 ms	
Bounce	1.2 ms							
Insulation coil / contact	4000 V RMS							
Resistance to shock coil / contact	4000 V RMS							
Insulation contact / contact	1000 V RMS							
Ambient temperature	storage	-40 °C to -80 °C						
	operating	-20 °C to 70 °C ¹⁾						
Other characteristics								
Body material	grey	Screw clamp			Spring clamp			
Wire size	Solid wire	0.2 - 4 mm ² (24-12 AWG)			0.2-2.5 mm ² (24-12 AWG)			
	Stranded wire	0.22 - 2.5 mm ² (24-12 AWG)						
Rated wire size	2.5 mm ² (12 AWG)							
Wire stripping length	9 mm (0.354 in)							
Recommended screwdriver	3.5 mm (0.137 in)							
Protection	IP20 NEMA1							
Recommended torque	0.4-0.6 Nm (3.5-5.3 lb.in)							
Approvals	UL (pending for 12 V DC) , CE (pending), LRS , CE							
Reference standards	CEI 947-7-1 / CEI 947-1 / CEI 1131-2 (in relevant parts) / CEI 60664-1 / CEM : IRC 1000-4-2, 3, 4, 5, 6.							

¹⁾ Over 55°C, blocks have to be mounted on horizontal rail with 10 mm spacing between each block. For vertical rail mounting use temperature is 15°C less decreased.

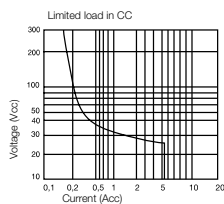

	DC12	AC12	DC13	AC15
24 V	6 A	6 A	1 A	3 A
110/120 V	0.3 A	6 A	0.2 A	3 A
220/230 V	0.2 A	6 A	0.1 A	3 A

Dimensional drawings

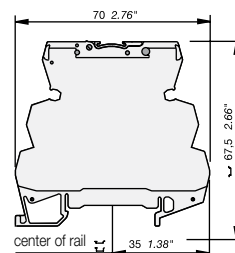

Screw clamp module

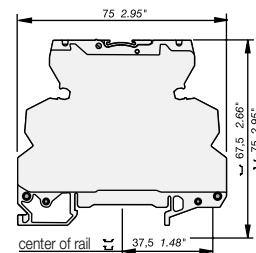

Spring clamp module

Interface relays, R600

Technical information

Technical data

Relay : 1 SPDT low level with contact 1 mA upto 6 A - 6 m 0.236" spacing

6

		RB 121			RB 121 A					
Relay characteristics coil										
Rated voltage: +20%, -15% on DC ; 10%, -10% on AC		5 V DC	12 V DC	24 V DC	24 VAC/DC	48 VAC/DC	60 V AC/DC	115 V AC/DC	230 V AC/DC ± 10% on AC ± 10%-15% on DC	
Frequency		50/60 Hz								
Power		0.2 W	0.2 W	0.28 W	0.24 W	0.33 W	0.54 W	0.46 W	0.8 W	
Rated current		40 mA	16 mA	12 mA	10 mA	7 mA	9 mA	4 mA	3.5 mA	
Drop-out voltage at 20°C		1.2 V	2.2 V	1.2 V	4.5 V	8 V	8 V	17 V	27 V	
Status device		green LED								
Relay characteristics contact										
Type		1 SPDT								
Voltage switching range min./max.		5 V / 250 V AC								
Current switching range min./max.		1 mA / 6 A								
Load switching range		0.05 VA / 1500 VA (ohmic load)								
		0.05 W / 140 W								
Number of on-load operations		10 ⁵ on AC15								
Number of off-load operations		10 ⁷								
Operation speed		F	5 ms	5 ms	5 ms	5 ms	5 ms	5 ms	6 ms	7 ms
		O	8 ms	8 ms	8 ms	8 ms	8 ms	8 ms	15 ms	16 ms
Insulation coil / contact		4000 V RMS								
Resistance to shock coil / contact		4000 V RMS								
Insulation contact / contact		1000 V RMS								
Ambient temperature		storage	-40 °C to -80 °C							
		operating	-20 °C to 70 °C ¹⁾							
Other characteristics		Screw clamp				Spring clamp				
Body material		grey				UL 94 V0				
Wire size		Solid wire 0.2 - 4 mm ² (24-12 AWG)				0.2-2.5 mm ² (24-12 AWG)				
		Stranded wire				0.22 - 2.5 mm ² (24-12 AWG)				
Rated wire size		2.5 mm ² (12 AWG)								
Wire stripping length		9 mm (0.354 in)								
Recommended screwdriver		3.5 mm (0.137 in)								
Protection		IP20 NEMA7								
Recommended torque		0.4-0.6 Nm (3.5-5.3 lb.in)								
Approvals		UL (pending for 24 V DC), (pending), LRS, CE								
Reference standards		CEI 947-7-1 / CEI 947-1 / CEI 1131-2 (in relevant parts) / CEI 60664-1 / CEM : IRC 1000-4-2, 3, 4, 5, 6.								

¹⁾ Over 55°C, blocks have to be mounted on horizontal rail with 10 mm spacing between each block. For vertical rail mounting use temperature is 15°C less decreased.

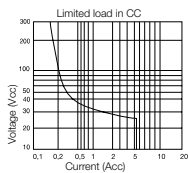

	DC12	AC12	DC13	AC15
24 V	6 A	6 A	1 A	3 A
110/120 V	0.3 A	6 A	0.2 A	3 A
220/230 V	0.2 A	6 A	0.1 A	3 A

Dimensional drawings

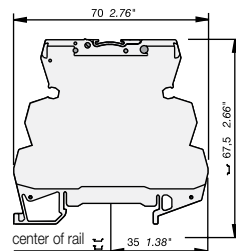

Screw clamp module

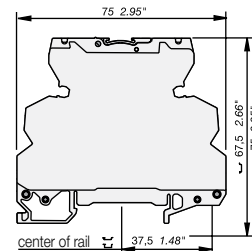



Spring clamp module





Interface relays, R600

Technical information

Interface relays
R600 & R500 Range

Technical data

-  Relay : 1 SPDT high level with switch or large coil voltage range or with leakage current protection 12 mm 0.472" spacing
-  Relay : 1 SPDT low level with switch - 12 mm 0.472" spacing

	RB 121 AR		RB 121AI		RB 121 AI		RB 121 AI		
Relay characteristics coil									
Rated voltage: +20%, -15% on DC ; 10%, -10% on AC	115 V AC/DC		230 V AC/DC ± 10% on AC ± 10%-15% on DC		24 VAC/DC		24 VAC/DC		
Frequency	50/60 Hz								
Power	2 W		2.8 W		0.24 W		0.24 W		
Rated current	18 mA		12 mA		10 mA		10 mA		
Drop-out voltage at 20°C	17 V		27 V		4.5 V		4.5 V		
Permissible leakage current	1.6 mA		1 mA						
Status device	green LED								
Relay characteristics contact									
Type	1 SPDT								
Voltage switching range min./max.	12 V / 250 V AC				5 V / 250 V		12 V / 250 V		
Current switching range min./max.	10 mA / 6 A								
Load switching range	AC1 min./max.	0.6 VA / 1500 VA (ohmic load)				0.05 VA / 1500 VA (ohmic load)		0.6 VA / 1500 VA (ohmic load)	
	DC1 min./max.	0.6 W / 140 W				0.05 W / 140 W		0.6 W / 140 W	
Number of on-load operations	10 ⁵ on AC15								
Number of off-load operations	10 ⁷								
Operation speed	F	6 ms	7 ms	5 ms	5 ms	5 ms	7 ms		
	O	15 ms	16 ms	8 ms	8 ms	8 ms	20 ms		
Insulation coil / contact	4000 V RMS								
Resistance to shock coil / contact	4000 V RMS								
Insulation contact / contact	1000 V RMS								
Ambient temperature	storage	-40 °C to -80 °C							
	operating	-20 °C to 70 °C ¹⁾							
Other characteristics									
Body material	grey				UL 94 V0		Spring clamp		
Wire size	Solid wire	0.2 - 4 mm ² (24-12 AWG)				0.22 - 2.5 mm ² (24-12 AWG)			
	Stranded wire					0.22 - 2.5 mm ² (24-12 AWG)			
Rated wire size					2.5 mm ² (12 AWG)				
Wire stripping length					9 mm (0.354 in)				
Recommended screwdriver					3.5 mm (0.137 in)				
Protection					IP20 NEMA1				
Recommended torque					0.4-0.6 Nm (3.5-5.3 lb.in)				
Approvals	  (pending),  , 								
Reference standards	CEI 947-7-1 / CEI 947-1 / CEI 1131-2 (in relevant parts) / CEI 60664-1 / CEM : IRC 1000-4-2, 3, 4, 5, 6.								

¹⁾ Over 55°C, blocks have to be mounted on horizontal rail with 10 mm spacing between each block. For vertical rail mounting use temperature is 15°C less decreased.

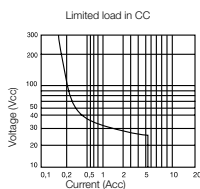

	DC12	AC12	DC13	AC15
24 V	6 A	6 A	1 A	3 A
110/120 V	0.3 A	6 A	0.2 A	3 A
220/230 V	0.2 A	6 A	0.1 A	3 A

Dimensional drawings

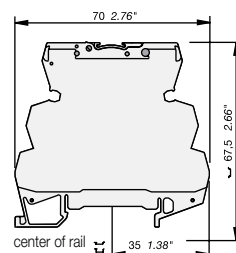

Screw clamp module

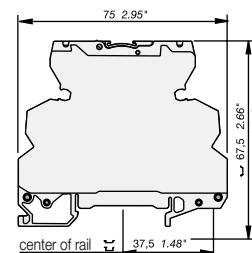

Spring clamp module

Interface relays, R600

Technical information

Technical data

Relay : 1 DPDT low level contact 1 mA to 8 A - 12 mm 0.472" spacing

6

		RB ... 122A				
Relay characteristics coil						
Rated voltage: +20%, -15% on DC ; 10%, -10% on AC	24 V AC/DC	48 V AC/DC	60 V AC/DC	115 V AC/DC	230 V AC/DC ± 10% on AC ± 10%-15% on DC	
Frequency	50/60 Hz					
Power	0.48 W	0.62 W	0.96 W	0.58 W	1.15 W	
Rated current	20 mA	13 mA	16 mA	5 mA	5 mA	
Drop-out voltage at 20°C	5.4 V	8.8 V	8.8 V	20 V	10 V	
Status device	green LED					
Relay characteristics contact						
Type	1 DPDT					
Voltage switching range min./max.	5 V / 250 V DC - 250 V AC					
Current switching range min./max.	1 mA / 8 A		1 mA / 5 A			
Load switching range	5 mVA / 1500 VA (ohmic load)					
	5 mW / 192 W					
Number of on-load operations	10 ⁵					
Number of off-load operations	2 x 10 ⁷					
Operation speed	F	6 ms	10 ms	10 ms	6 ms	6 ms
	O	10 ms	14 ms	14 ms	15 ms	15 ms
Bounce	1 ms					
Insulation coil / contact	3500 V RMS					
Resistance to shock coil / contact	3500 V RMS					
Insulation contact / contact	3500 V RMS (between 2 contacts)					
Ambient temperature	storage	-40 °C to -80 °C				
	operating	-20 °C to 70 °C ¹⁾				
Other characteristics		Screw clamp		Spring clamp		
Body material	grey	UL 94 V0				
Wire size	Solid wire	0.2 - 4 mm ² (24-12 AWG)		0.2-2.5 mm ² (24-12 AWG)		
	Stranded wire			0.22 - 2.5 mm ² (24-12 AWG)		
Rated wire size				2.5 mm ² (12 AWG)		
Wire stripping length				9 mm (0.354 in)		
Recommended screwdriver				3.5 mm (0.137 in)		
Protection				IP20 NEMA1		
Recommended torque				0.4-0.6 Nm (3.5-5.3 lb.in)		
Approvals		cULus (pending for 12 V DC) , CE (pending), LRS , CE				
Reference standards		CEI 947-7-1 / CEI 947-1 / CEI 1131-2 (in relevant parts) / CEI 60664-1 / CEM : IRC 1000-4-2, 3, 4, 5, 6.				

¹⁾ Over 55°C, blocks have to be mounted on horizontal rail with 10 mm spacing between each block. For vertical rail mounting use temperature is 15°C less decreased.

Max. DC load breaking capacity

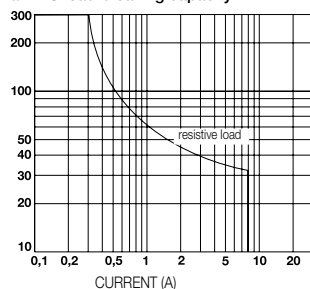

Dimensional drawings

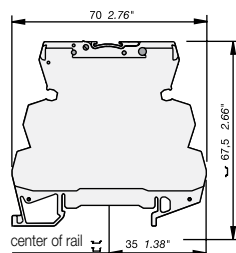

Screw clamp module

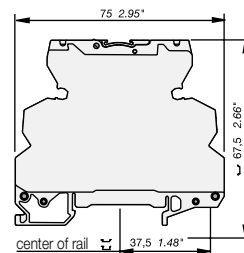

Spring clamp module

Interface relays, R500 Selection

Interface relays
R600 & R500 Range

	Reference code	Catalog number
	D 2,5/5-R121-24VDC	1SNA645047R0000
	D 2,5/5-R121L-24VDC	1SNA645547R0200
	D 2,5/5-R121AL-24VAC/DC	1SNA645021R2600
	D 2,5/5-R121AL-48VAC/DC	1SNA645521R2000
	D 2,5/5-R121BL-110VAC	1SNA645049R1200
	D 2,5/5-R121BL-230VAC	1SNA645549R1400
Input voltage		
24 V DC	■	■
48 V DC		■
24 V AC		■
48 V AC		■
110 V AC		■
230 V AC		■
Output rating		
10 mA - 6 A	■	■
Output contacts		
c/o	1	1
Type		
with LED		■
without LED	■	



R500 series

It is our range offering pluggable functions

- Spacing : 5.08 mm (the smallest in the market)
- Wire size : 2.5 mm² (4 mm² solid)
- Contact type : 1 SPDT from 10 mA to 6 A / 250 V
- Transistor : 30 mA to 100 mA
MOS : 1 A to 2 A
Triac : 1 A

Interface relays, R500

Ordering details

6



R500

Description of R500 Relay	Reference code	Catalog number	Pkg qty	Weight (1 pce) kg (lb)
<input type="checkbox"/> Relay module 1 SPDT high level	D 2,5/5-R121-24VDC	1SNA607217R0200	10	0.032 (0.071)
	D 2,5/5-R121L-24VDC	1SNA607201R1300		
	D 2,5/5-R121AL-24VAC/DC	1SNA607231R0000		
<input type="checkbox"/> Relay module with LED 1 SPDT high level	D 2,5/5-R121AL-48VAC/DC	1SNA607232R0100	10	0.04 (0.088)
	D 2,5/5-R121BL-110VAC	1SNA607264R1100		
	D 2,5/5-R121BL-230VAC	1SNA607265R1200		

R500 Accessories	Reference code	Catalog number	Pkg qty	Weight (1 pce) kg (lb)
High end stop	BAMH 9,1 mm	011483600	50	
	BAMH V0 9,1 mm	019483601		
	BADH 12 mm	011690027		
Comb type jumper bar 2 to 22 poles		consult us		
Jumper bar 10 poles grey ■	PCMS V0	1SNA205523R2200	8	
Relay / Opto base	D 2,5/5-MP	1SNA607224R0100	10	0.028 (0.062)
Relay / Opto base with LED 24 VDC	D 2,5/5-MP-24VDC	1SNA607222R0700		
Relay / Opto base with LED 24 VAC/VDC	D 2,5/5-MP-24VAC/DC	1SNA607260R2100		
Relay / Opto base with LED 48 VAC/VDC	D 2,5/5-MP-48VAC/DC	1SNA607261R1600		
Relay / Opto base with LED 110 VAC	D 2,5/5-MP-110VAC	1SNA607266R1300		
Relay / Opto base with LED 230 VAC	D 2,5/5-MP-230VAC	1SNA607267R1400		
Plug relay 24 V 1 SPDT 10 mA to 6 A	BNMS R24V-1	1SNA031820R1400	4	
Plug relay 24 V 1 SPDT 1 mA to 6 A	BNMS R24V-2	1SNA031847R1300		
Test device blue	DCB ¹⁾	1SNA105028R2100	10	
Test plug DIA. 2 mm	FC2	000786526		
Marking method	RC55	see marking		

¹⁾ Only on top decks

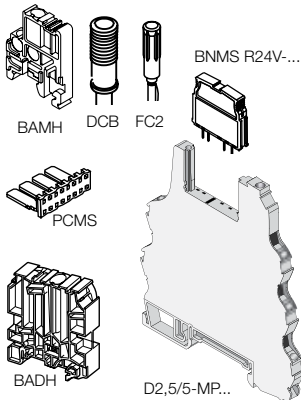

Connection diagrams

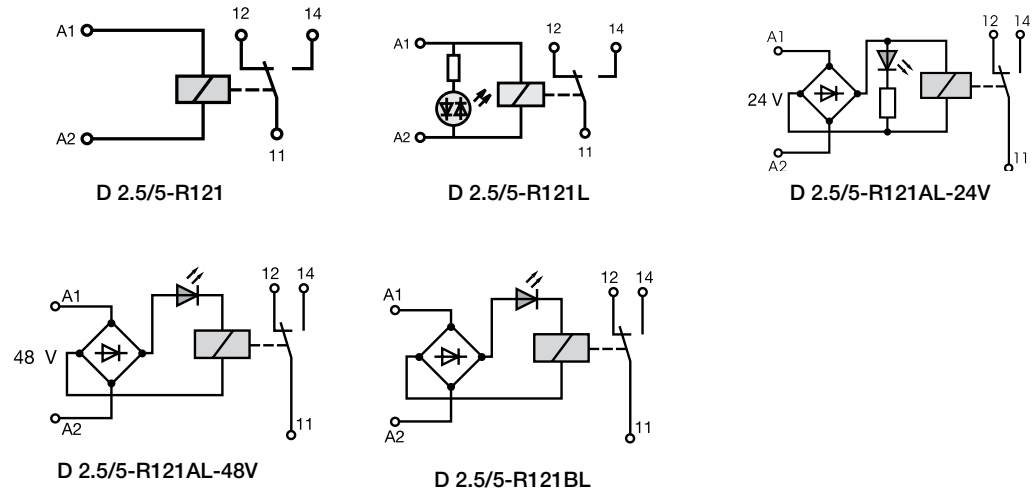

Interface relays, R500

Technical information



Interface relays
R600 & R500 Range

Technical data

Relay : 1 SPDT high level with contact 10 mA to 6 A - 5.08mm 0.200" spacing

	D 2.5/5-R121	D 2.5/5-R121L	D 2.5/5-R121AL				D 2.5/5-R121BL	
Relay characteristics coil								
Rated voltage: +20%, -15% on DC ; 10%, -10% on AC	24 V DC	24 V DC	24 V AC	24 V DC	48 V AC	48 V DC	110 V AC	230 V AC
Frequency			50/60 Hz		50/60 Hz		50/60 Hz	50/60 Hz
Power	0.17 W	0.3 W	0.35 W	0.35 W	0.44 W	0.47 W	1.08 W	2.13 W
Rated current	7 mA	12 mA	12.4 mA	10 mA	7.6 mA	6.8 mA	8.4 mA	8 mA
Drop-out voltage at 20°C	2.4 V	2.4 V	4.8 V	4.8 V	10 V	10 V	25 V	45 V
Status device	green LED							

Relay characteristics contact									
Type	1 SPDT								
Voltage switching range min./max.	12 V / 250 V AC								
Current switching range min./max.	10 mA / 6 A								
Load switching range	AC1 min./max.				0.6 VA / 1500 VA (ohmic load)				
	DC1 min./max.				0.6 W / 140 W				
Number of on-load operations	10 ⁵ on AC15								
Number of off-load operations	10 x 10 ⁷								
Operation speed	F	5 ms	5 ms	5 ms	5 ms	5 ms	5 ms	6 ms	7 ms
	O	8 ms	8 ms	15 ms	15 ms	15 ms	15 ms	15 ms	15 ms
Insulation coil / contact	4000 V RMS								
Resistance to shock coil / contact	4000 V RMS								
Insulation contact / contact	1000 V RMS								
Ambient temperature	storage								
	operating								
								-40 °C to -80 °C	
								See derating curves	

Other characteristics								
Body material	grey				UL 94 V0			
Wire size	Solid wire				0.2 - 4 mm ² (24-12 AWG)			
	Stranded wire				0.22 - 2.5 mm ² (24-12 AWG)			
Rated wire size	2.5 mm ² (12 AWG)							
Wire stripping length	10 mm (0.394 in)							
Recommended screwdriver	3.5 mm (0.137 in)							
Protection	IP20 NEMA1							
Recommended torque	0.4-0.6 Nm (3.5-5.3 lb.in)							
Approvals	c  us (pending) , 							
Reference standards	CEI 947-7-1 / CEI 947-1 / CEI 1131-2 (in relevant parts) / CEI 60664-1 / CEM : IRC 1000-4-2, 3, 4, 5, 6.							

	DC12	AC12	DC13	AC15
24 V	6 A	6 A	1 A	3 A
110/120 V	0.3 A	6 A	0.2 A	3 A
220/230 V	0.2 A	6 A	0.1 A	3 A

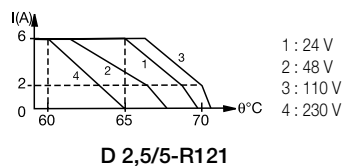
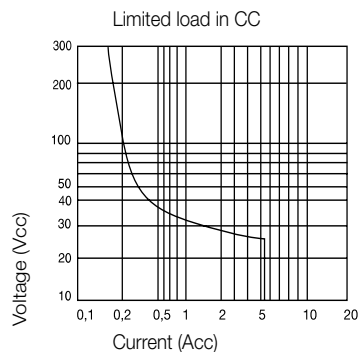

Dimensional drawings

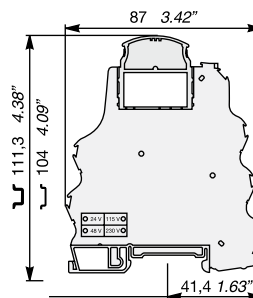



Optocouplers
R600 & R500

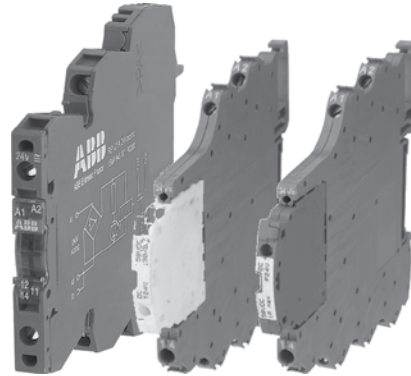

R600 & R500 Optocouplers

R600 Optocouplers Selection

OBROA 1000-24VDC	1SNA645527R2600
OBROA 2000-24VDC	1SNA645529R0000
OBOA 1000-48-60VAC/DC	1SNA645061R0600
OBROA 1000-48-60VAC/DC	1SNA645561R0000
OBOA 1000-115VAC/DC	1SNA645062R0700
OBROA 1000-115VAC/DC	1SNA645562R0100
OBOA 1000-230VAC/DC	1SNA645028R0500
OBROA 1000-230VAC/DC	1SNA645528R0700

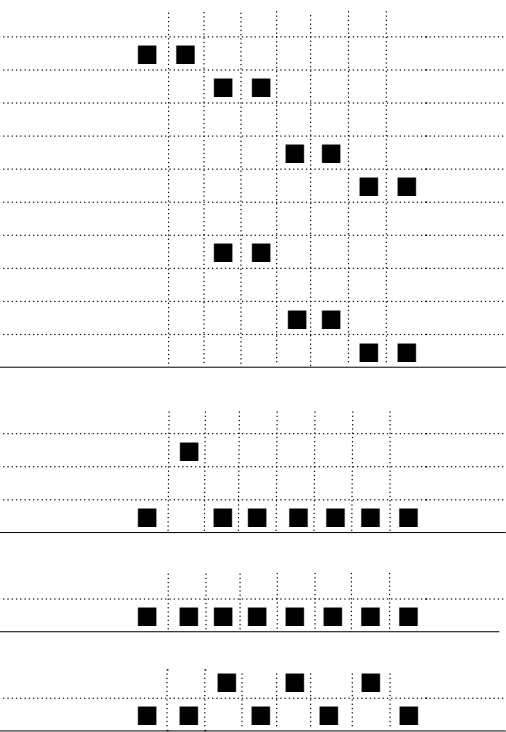

R600 Optocouplers

Ordering details

6



R600 Optocoupler		Reference code	Catalog number	Pkg qty	Weight (1 pce) kg (lb)
Optocoupler module 100 mA/DC		OBIC 0100-5-12VDC	1SNA645047R0000	10	0.02 (0.44)
		OBIC 0100-24VDC	1SNA645021R2600		
		OBIC 0100-48-60VAC/DC	1SNA645049R1200		
		OBIC 0100-115-230VAC/DC	1SNA645022R2700		
Optocoupler module 100 mA/DC		OBRIC 0100-5-12VDC	1SNA645547R0200	10	0.02 (0.44)
		OBRIC 0100-24VDC	1SNA645521R2000		
		OBRIC 0100-48-60VAC/DC	1SNA645549R1400		
		OBRIC 0100-115-230VAC/DC	1SNA645522R2100		
Optocoupler module 2 A/DC		OBOC 1000-5-12VDC	1SNA645050R1700	10	0.02 (0.44)
		OBOC 1000-24VDC	1SNA645051R0400		
		OBOC 1500-24VAC/DC	1SNA645025R2200		
		OBOC 1000-48-60VAC/DC	1SNA645053R0600		
		OBOC 1000-115VAC/DC	1SNA645054R0700		
		OBOC 1000-230VAC/DC	1SNA645026R2300		
Optocoupler module 2 A/DC		OBROC 1000-5-12VDC	1SNA645550R1100	10	0.02 (0.44)
		OBROC 1000-24VDC	1SNA645551R0600		
		OBROC 1500-24VAC/DC	1SNA645525R2400		
		OBROC 1000-48-60VAC/DC	1SNA645553R0000		
		OBROC 1000-115VAC/DC	1SNA645554R0100		
		OBROC 1000-230VAC/DC	1SNA645526R2500		
Optocoupler module 5 A/DC		OBOC 5000-24VDC	1SNA645 024 R2100	10	0.02 (0.44)
		OBOC 5000-115VAC/DC	1SNA645058R1300		
		OBOC 5000-230VAC/DC	1SNA645059R1400		
Optocoupler module 5 A/DC		OBROC 5000-24VDC	1SNA645524R2300	10	0.02 (0.44)
		OBROC 5000-115VAC/DC	1SNA645558R1500		
		OBROC 5000-230VAC/DC	1SNA645559R1600		
Optocoupler module 1 A/AC 6 mm spacing		OBOA 1000-24VDC	1SNA645027R2400	10	0.03 (0.066)
		OBOA 1000-48-60VAC/DC	1SNA645061R0600		
		OBOA 1000-115VAC/DC	1SNA645062R0700		
		OBOA 1000-230VAC/DC	1SNA645028R0500		
Optocoupler module 2 A/AC 12 mm spacing		OBOA 2000-24VDC	1SNA645029R0600	5	0.03 (0.066)
Optocoupler module 1 A/AC 6 mm spacing		OBROA 1000-24VDC	1SNA645527R2600	10	0.03 (0.066)
		OBROA 1000-48-60VAC/DC	1SNA645561R0000		
		OBROA 1000-115VAC/DC	1SNA645562R0100		
		OBROA 1000-230VAC/DC	1SNA645528R0700		
Optocoupler module 2 A/AC 12 mm spacing		OBROA 2000-24VDC	1SNA645529R0000	5	0.03 (0.066)

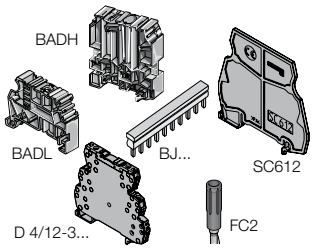

Accessories	Reference code	Catalog number	Pkg qty	Weight (1 pce) kg (lb)
End section	BADH V0	011690027	50	
	BADL V0	039990302	50	
	BAM2 V0	039996701	50	
Separator end section	SC 612	1SNA290474R0200	10	
Divisible shunt 10 poles	BJ 612-10	1SNA290488R0100	10	
Screw clamp distribution block sp. 12 mm	D4/12-3-3	1SNA645031R2000	5	
Spring clamp distribution block sp. 12 mm	D4/12-3R-3R	1SNA645531R2200	5	
Test plug DIA. 2 mm	FC2	000786526	10	
Marking method	RC65 / RC610	see marking		

R600 Optocouplers

Connection diagrams

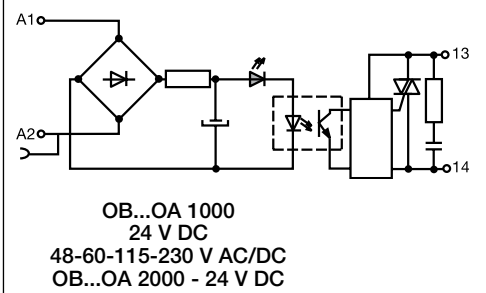
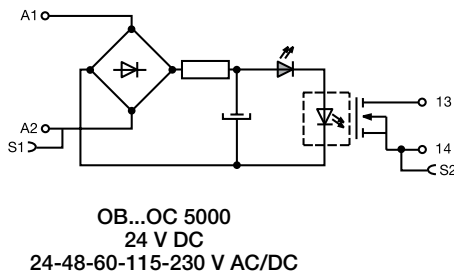
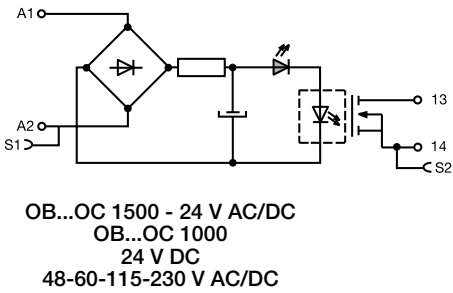
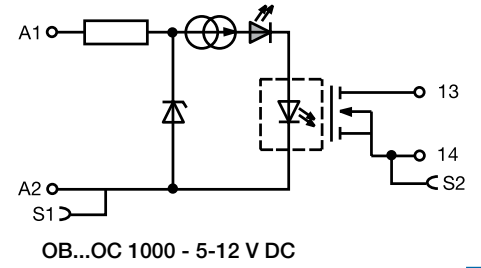
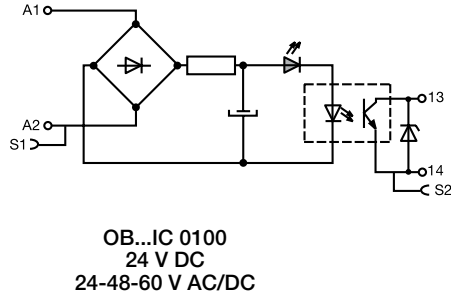
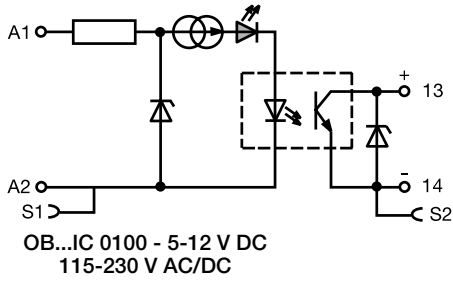





R600 Optocouplers

Technical data

Technical data

Optocoupler : 5 to 58 V DC output / 100 mA - 6 mm 0.236" spacing

		OB...IC 0100			
Relay characteristics coil		5 V DC - 12 V DC		24 V DC	48 V AC/DC 60 V AC/DC 115 V AC/DC 230 V AC/DC
Input voltage: +20%, -15% on DC ; 10%, -10% on AC					
Frequency					50 / 60 Hz
Input current AC/DC		5 mA	9 mA	4 mA	4 mA 5 mA 7 mA / 16 mA 11.5 mA / 25 mA
6	Pull-in voltage at Is=100%	4 V		15 V	25 V 60 V AC / 70 V DC
Switching time C / O		10 μs / 500 μs			
Operating frequency		1000 Hz			5 ms / 20 ms 5 ms / 15 ms
Permissible leakage current					20 Hz
Output		0.9 mA	1 mA		0.9 mA 1.6 mA
Output voltage					4.5 to 58 V DC
Output current min.					1 mA
Output current max.					100 mA
Output leakage current at U _{max}					< 50 μA
Residual voltage at I max and U rated		typical			1 V
		max			1.3 V
Frequency on inductive load					
Isolation Input / Output		input / Output			2500 V RMS
Temperature		storage			-40...+80 °C
		operating			-20...+70 °C ¹⁾
Other characteristics		Screw clamp		Spring clamp	
Body material		grey		UL 94 V0	
Wire size		Solid wire		0.2 - 4 mm ² (24-12 AWG)	
		Stranded wire		0.22 - 2.5 mm ² (24-12 AWG)	
Rated wire size				2.5 mm ² (12 AWG)	
Wire stripping length				9 mm (0.354 in)	
Recommended screwdriver				3.5 mm (0.137 in)	
Protection				IP20 NEMA1	
Recommended torque				0.4-0.6 Nm (3.5-5.3 lb.in)	
Approvals				e  us (pending for 12 V DC) ,  (pending),  , LRS , 	
Reference standards		CEI 947-7-1 / CEI 947-1 / CEI 1131-2 (in relevant parts) / CEI 60664-1 / CEM : IRC 1000-4-2, 3, 4, 5, 6.			

¹⁾ Over 55°C, blocks have to be mounted on horizontal rail with 10 mm spacing between each block. For vertical rail mounting use temperature is 15°C less decreased.

Dimensional drawings

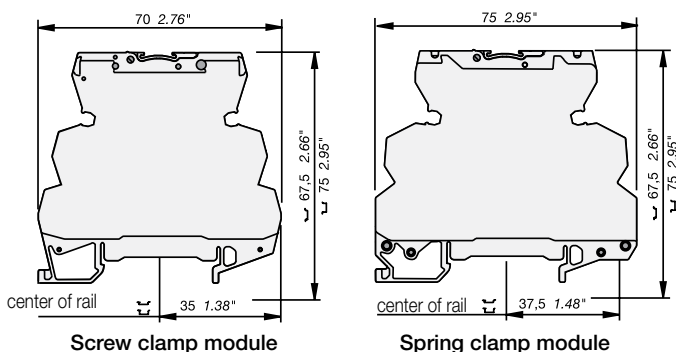

R600 Optocouplers

Technical data

Optocouplers
R600 & R500 Range

Technical data

Optocoupler : 5 to 58 V DC output / 2 A - 6 mm 0.236" spacing

	OB...IC 0100		OB..OC 1500	OB...OC 1000				
Relay characteristics coil								
Input voltage: +20%, -15% on DC ; 10%, -10% on AC	5 V DC - 12 V DC		24 V DC	24 V AC/DC	48 V AC/DC	60 V AC/DC	115 V AC/DC	230 V AC/DC
Frequency				50 / 60 Hz				
Input current	5 mA	9 mA	4 mA	6.3 mA	4 mA	5.1 mA	4.2 mA	4 mA
Pull-in voltage at Is=100%	4 V		15 V	15 V	27 V		50 V	80 V
Switching time C / O	15 μ s / 250 μ s		30 μ s / 400 μ s	1 ms / 7 ms	5 ms / 20 ms		500 μ s / 10 ms	1 ms / 15 ms
Operating frequency	2000 Hz		1000 Hz	60 Hz	20 Hz			
Permissible leakage current	1 mA		0.8 mA	0.9 mA	1 mA		0.3 mA	
Output								
Output voltage				4.5 to 58 V DC				
Output current min.				1 mA				
Output current max.				2 A				
Output leakage current at U _{max}				< 50 μ A				
Residual voltage at I max and U rated	typical			0.1 V				
	max			0.5 V				
Frequency on inductive load								
Isolation Input / Output	input / Output			2500 V RMS				
Temperature	storage			-40...+80 °C				
	operating			-20...+70 °C ¹⁾				
Other characteristics			Screw clamp	Spring clamp				
Body material	grey			UL 94 V0				
Wire size	Solid wire		0.2 - 4 mm ² (24-12 AWG)	0.2-2.5 mm ² (24-12 AWG)				
	Stranded wire			0.22 - 2.5 mm ² (24-12 AWG)				
Rated wire size				2.5 mm ² (12 AWG)				
Wire stripping length				9 mm (0.354 in)				
Recommended screwdriver				3.5 mm (0.137 in)				
Protection				IP20 NEMA1				
Recommended torque				0.4-0.6 Nm (3.5-5.3 lb.in)				
Approvals				UL (pending for 12 V DC) , CE (pending), LRS , CE				
Reference standards				CEI 947-7-1 / CEI 947-1 / CEI 1131-2 (in relevant parts) / CEI 60664-1 / CEM : IRC 1000-4-2, 3, 4, 5, 6.				

¹⁾ Over 55°C, blocks have to be mounted on horizontal rail with 10 mm spacing between each block. For vertical rail mounting use temperature is 15°C less decreased.

Dimensional drawings

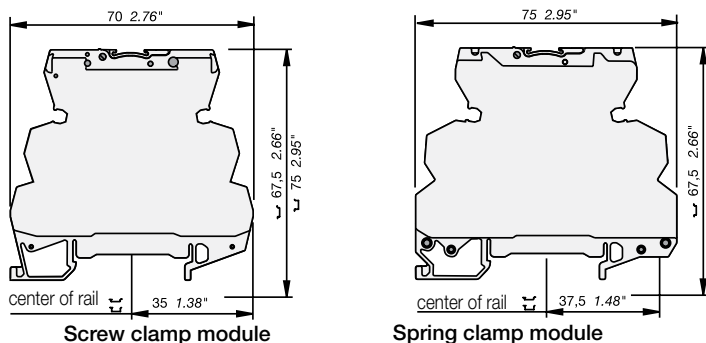

R600 Optocouplers

Technical data

Technical data

Optocoupler : 5 to 58 V DC output / 5 A - 6 mm 0.236" spacing

OB... OC 5000

Input

Input voltage	24 V DC	115 V AC/DC	230 V AC/DC
Frequency		50 / 60 Hz	50 / 60 Hz
Input current	5.4 mA	4.2 mA	4 mA
Pull-in voltage at Is=100%	12 V	50 V	80 V
Switching time C / O	30 μs / 400 μs	500 μs / 10 ms	1ms / 15 ms
Operating frequency	1000 Hz	50 Hz	35 Hz
Permissible leakage current	0.8 mA	0.3 mA	0.3 mA



Output

Output voltage		4.5- 58 V DC	
Output current min.		25 mA	
Output current max.		1 A	
Output leakage current at U _{max}		< 0.50 mA	
Redidual voltage at I max and U rated	typical	1 V	
	max	1.6 V	
Frequency on inductive load		See Note 1	
Isolation Input / Output	input / Output	2500 V RMS	

Temperature

Ambient temperature	storage	-40...+80 °C
	operating	See derating curve

Other characteristics

Body material	grey	UL 94 V0
Wire size	Solid wire	0.2 - 4 mm ² (24-12 AWG)
	Stranded wire	0.22 - 2.5 mm ² (24-12 AWG)
Rated wire size		2.5 mm ² (12 AWG)
Wire stripping length		10 mm (0.394 in)
Recommended screwdriver		3.5 mm (0.137 in)
Protection		IP20 NEMA1
Recommended torque		0.4-0.6 Nm (3.5-5.3 lb.in)
Approvals		 us (pending), 
Reference standards		CEI 947-7-1 / CEI 947-1 / CEI 1131-2 (in relevant parts) / CEI 60664-1 / CEM : IRC 1000-4-2, 3, 4, 5, 6.

Dimensional drawings

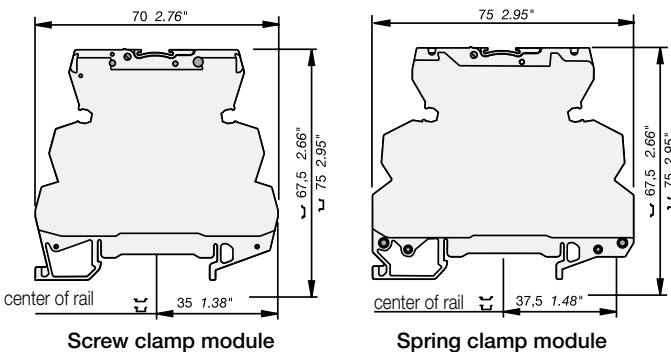





R600 Optocouplers

Technical data

Optocouplers
R600 & R500 Range

Technical data

Optocoupler : 24 to 400 V AC output / 2 A max. - 6 mm or 12 mm spacing

	OB...OA 1000					OB...OA 2000
Relay characteristics coil						
Input voltage: +20%, -15% on DC ; 10%, -10% on AC	24 V DC	48 V AC/DC	60 V AC/DC	115 V AC/DC	230 V AC/DC	24 V DC
Frequency	50/60 Hz					
Input current	3.6 mA	4.3 mA	5.5 mA	4.15 mA	4.6 mA	3.6 mA
Pull-in voltage at Is=100%	14 V	15 V	18 V	60 V	135 V	14 V
Switching time C / O	150 μs / 1 ms	3 ms / 30 ms		2.2 ms / 18 ms	2.5 ms / 25 ms	150 μs / 1 ms
Operating frequency	500 Hz	20 Hz		25 Hz	20 Hz	500 Hz
Permissible leakage current	1 mA					
Output						
Output voltage	24-58 V AC					
Frequency	50/60 Hz					
Output current min.	25 mA					
Output current max.	1 A					2 mA
Output leakage current at U _{max}	< 0.50 mA					
Residual voltage at I max and U rated	typical					1 V
	max					1.6 V
Frequency on inductive load						
Isolation Input / Output	input / Output	2500 V RMS				
Temperature	storage	-40...+80 °C				
	operating	-20...+70 °C ¹⁾				
Other characteristics						
Body material	grey	Screw clamp		Spring clamp		UL 94 V0
Wire size	Solid wire	0.2 - 4 mm ² (24-12 AWG)		0.2-2.5 mm ² (24-12 AWG)		
	Stranded wire	0.22 - 2.5 mm ² (24-12 AWG)				
Rated wire size	2.5 mm ² (12 AWG)					
Wire stripping length	9 mm (0.354 in)					
Recommended screwdriver	3.5 mm (0.137 in)					
Protection	IP20 NEMA1					
Recommended torque	0.4-0.6 Nm (3.5-5.3 lb.in)					
Approvals	c  us (pending for 12 V DC) ,  (pending),  , LRS , 					
Reference standards	CEI 947-7-1 / CEI 947-1 / CEI 1131-2 (in relevant parts) / CEI 60664-1 / CEM : IRC 1000-4-2, 3, 4, 5, 6.					

¹⁾ Over 55°C, blocks have to be mounted on horizontal rail with 10 mm spacing between each block. For vertical rail mounting use temperature is 15°C less decreased.

Dimensional drawings

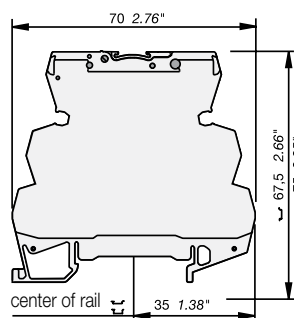

Screw clamp module

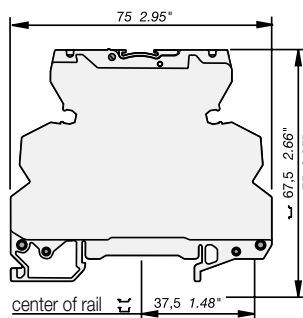

Spring clamp module

R500 Optocouplers Selection

6

Reference code	Catalog number
D 2,5/5-OBIC-0030-5VDC	1SNA607274R1300
D 2,5/5-OBIC-0030-24VDC	1SNA607210R1700
D 2,5/5-OBIC-0030-48VDC	1SNA607211R0400
D 2,5/5-OBIC-0030-125VDC	1SNA607275R1400
D 2,5/5-OBIA-0030-24VAC	1SNA607212R0500
D 2,5/5-OBIA-0030-48VAC	1SNA607213R0600
D 2,5/5-OBIA-0030-115VAC	1SNA607214R0700
D 2,5/5-OBIA-0030-230VAC	1SNA607215R0000
D 2,5/5-OBOC-0100-5VDC	1SNA607203R1500
D 2,5/5-OBOC-0100-24VDC	1SNA607204R1600
D 2,5/5-OBOC-0100-48VDC	1SNA607205R1700
D 2,5/5-OBOC-1000-5VDC	1SNA607206R1000
D 2,5/5-OBOC-1000-24VDC	1SNA607207R1100
D 2,5/5-OBOC-1000-24VAC/DC	1SNA607250R2700
D 2,5/5-OBOC-1000-48VAC/DC	1SNA607251R1400
D 2,5/5-OBOC-1000-110VAC	1SNA607270R2300
D 2,5/5-OBOC-1000-230VAC	1SNA607271R1000
D 2,5/5-OBOC-2000-5VDC	1SNA607208R2200
D 2,5/5-OBOC-2000-24VDC	1SNA607209R2300
D 2,5/5-OBOC-2000-24VAC/DC	1SNA607255R1000
D 2,5/5-OBOC-2000-48VAC/DC	1SNA607256R1100
D 2,5/5-OBOC-2000-110VAC	1SNA607272R1100
D 2,5/5-OBOC-2000-230VAC	1SNA607273R1200
D 2,5/5-OB0A-1000-24VDC	1SNA607238R1700
D 2,5/5-OB0A-1000-24VAC/DC	1SNA607240R2500
D 2,5/5-OB0A-1000-48VAC/DC	1SNA607241R1200
D 2,5/5-OB0A-1000-110VAC	1SNA607268R2500
D 2,5/5-OB0A-1000-230VAC	1SNA607269R2600

Input voltage																				
5 V DC	■																			
24 V DC		■																		
48 V DC			■																	
125 V DC				■																
24 V AC					■															
48 V AC						■														
110 V AC							■													
115 V AC								■												
230 V AC									■											■

Output rating																				
30 mA	■	■	■	■	■	■	■	■	■	■	■	■	■	■	■	■	■	■	■	■
100 mA									■	■	■	■	■	■	■	■	■	■	■	■
2 A																	■	■	■	■
1 A																			■	■

Output voltage																				
30 V DC																				
58 V DC	■	■	■	■	■	■	■	■	■	■	■	■	■	■	■	■	■	■	■	■
253 V AC																			■	■

Type																				
input optocoupler	■	■	■	■	■	■	■	■	■	■	■	■	■	■	■	■	■	■	■	■
output optocoupler																			■	■

R500 Optocouplers Selection

Optocouplers
R600 & R500 Range



Description of R600 Optocoupler	Reference code	Catalog number	Pkg qty	Weight (1 pce) kg (lb)
Optocoupler module 30 mA/DC	D 2,5/5-OBIC-0030-5VDC	1SNA607274R1300	1	0.032 (0.071)
	D 2,5/5-OBIC-0030-24VDC	1SNA607210R1700		
	D 2,5/5-OBIC-0030-48VDC	1SNA607211R0400		
	D 2,5/5-OBIC-0030-125VDC	1SNA607275R1400		
Optocoupler module 30 mA/AC	D 2,5/5-OBIA-0030-24VAC	1SNA607212R0500	1	0.032 (0.071)
	D 2,5/5-OBIA-0030-48VAC	1SNA607213R0600		
	D 2,5/5-OBIA-0030-115VAC	1SNA607214R0700		
	D 2,5/5-OBIA-0030-230VAC	1SNA607215R0000		
Optocoupler module 100 mA/DC	D 2,5/5-OBOC-0100-5VAC	1SNA607203R1500	1	0.032 (0.071)
	D 2,5/5-OBOC-0100-24VAC	1SNA607204R1600		
	D 2,5/5-OBOC-0100-48VAC	1SNA607205R1700		
Optocoupler module 1 A/DC	D 2,5/5-OBOC-1000-5VDC	1SNA607206R1000	1	0.04 (0.088)
	D 2,5/5-OBOC-1000-24VDC	1SNA607207R1100		
	D 2,5/5-OBOC-1000-24VAC/DC	1SNA607250R2700		
	D 2,5/5-OBOC-1000-48VAC/DC	1SNA607251R1400		
	D 2,5/5-OBOC-1000-110VAC	1SNA607270R2300		
	D 2,5/5-OBOC-1000-230VAC	1SNA607271R1000		
Optocoupler module 2 A/DC	D 2,5/5-OBOC-2000-5VDC	1SNA607208R2200	1	0.04 (0.088)
	D 2,5/5-OBOC-2000-24VDC	1SNA607209R2300		
	D 2,5/5-OBOC-2000-24VAC/DC	1SNA607255R1000		
	D 2,5/5-OBOC-2000-48VAC/DC	1SNA607256R1100		
	D 2,5/5-OBOC-2000-110VAC	1SNA607272R1100		
	D 2,5/5-OBOC-2000-230VAC	1SNA607273R1200		
Optocoupler module 1 A/DC	D 2,5/5-OBOA-1000-24VAC	1SNA607238R1700	1	0.032 (0.071)
	D 2,5/5-OBOA-1000-24VAC/DC	1SNA607240R2500		
	D 2,5/5-OBOA-1000-48VAC/DC	1SNA607241R1200		
	D 2,5/5-OBOA-1000-110VAC	1SNA607268R2500		
	D 2,5/5-OBOA-1000-230VAC	1SNA607269R2600		

6

BNMS P...

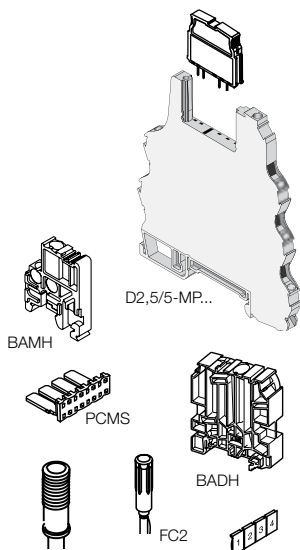

Description of Accessories	Reference code	Catalog number	Pkg qty	Weight (1 pce) kg (lb)
High end stop	BAMH 9.1 mm	011483600	50	
	BAMH V0 9.1 mm	019483601		
	BADH 12 mm	011690027		
Comb type jumper bar 2 to 22 poles		consult us		
Jumper bar 10 poles grey	PCMS V0	1SNA205523R2200	8	
Input opto base	D 2.5-5-MP1	1SNA607223R0000	10	0.028 (0.062)
Plug OBIC 5 V white	BNMS T5V-1	003183103	4	
Plug OBIC 24 V white	BNMS T24V-1	003180021		
Plug OBIC 48 V white	BNMS T48V-1	1SNA031801R1600		
Plug OBIC 125 V white	BNMS T125V-1	1SNA031845R1100		
Test device blue	DCB (1)	010502821	10	
Test plug DIA 2 mm	FC2	000786526		
Marking method	RC55	see marking		

R500 Optocouplers

Connection diagrams

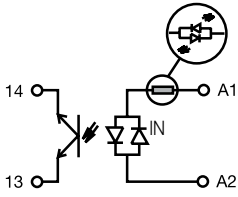

D 2.5/5-OBIC-0030

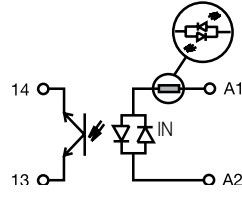

D 2.5/5-OBIA-0030

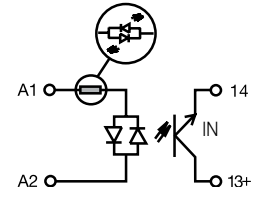

D 2.5/5-OBOC-0100

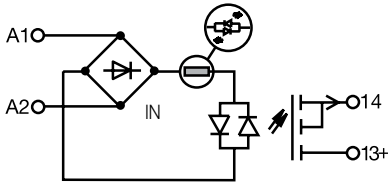

D 2.5/5-OBOC-1000
24/48 VAC/DC
110/230 VAC

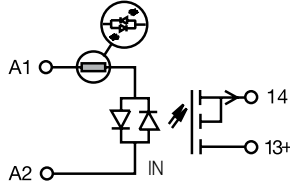

D 2.5/5-OBOC-1000 5/24 VDC

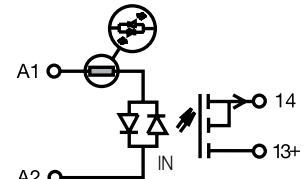

D 2.5/5-OBOC-2000

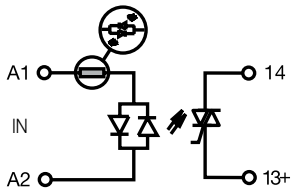

D 2.5/5-OBOA-1000



R500 Optocouplers

Technical data

Optocouplers
R600 & R500 Range

Technical data

Pluggable optocoupler : 5 to 58 V DC output / 30 mA - 5.08 mm 0.200" spacing

		D 2.5/5-OBIC-0030			
Input					
Input voltage		4.5 V to 5.5 VDC	19.2 V to 27.6 VDC	38.4 V to 55.2 VDC	93.5 V to 140 VDC
Input current		6 mA	5 mA	4.1 mA	3 mA
Pull-in voltage at Is=100%		3.5 V	12 V	21 V	50 V
Switching time C / O		20 μ s / 1.3 ms			
Operating frequency		400 Hz			
Permissible leakage current			1 mA	0.8 mA	
Output					
Output voltage		4.5 to 58 V DC			
Output current min.		0.5 mA			
Output current max.		30 mA			
Output leakage current at U _{max}		< 50 μ A			
Residual voltage at I max and U rated	typical	2.3 V DC			
	max	2.7 V DC			
Frequency on inductive load					
Isolation Input / Output	input / Output	2500 V RMS			
Ambient temperature	storage	-40...+80 °C			
	operating	See derating curve			
Other characteristics					
Body material	grey	UL 94 V0			
Wire size	Solid wire	0.2 - 4 mm ² (24-12 AWG)			
	Stranded wire	0.22 - 2.5 mm ² (24-12 AWG)			
Rated wire size		2.5 mm ² (12 AWG)			
Wire stripping length		9 mm (0.354 in)			
Recommended screwdriver		3.5 mm (0.137 in)			
Protection		IP20 NEMA1			
Recommended torque		0.4-0.6 Nm (3.5-5.3 lb.in)			
Approvals		c  us (pending), 			
Reference standards		CEI 947-7-1 / CEI 947-1 / CEI 1131-2 (in relevant parts) / CEI 60664-1 / CEM : IRC 1000-4-2, 3, 4, 5, 6.			

Derating curve

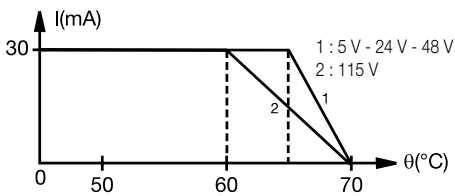

D 2.5/5-OBIC-0030

Dimensional drawings

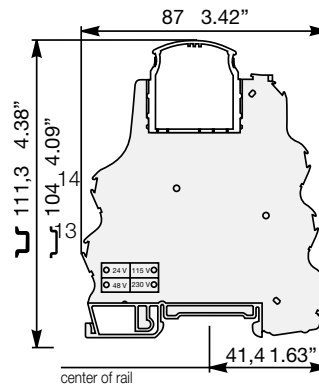

R500 Optocouplers

Technical data

Technical data

Pluggable optocoupler : 5 to 58 V DC output / 30 mA - 5.08 mm 0.200" spacing

D 2.5/5-OBIA-0030

Input	20.4 to 26.4 V AC	40.8 V to 52.8 V AC	98 V to 126.5 V AC	195.5 V to 253 V AC
Input voltage			50 / 60 Hz	50 Hz
Input current	8.5 mA	4.5 mA	8 mA	7 mA
Pull-in voltage at Is=100%	13 V	22 V	50 V	95 V
Switching time C / O	6 ms / 10 ms			
Operating frequency	30 Hz			
Permissible leakage current	1 mA		2 mA	

Output	4.5 V to 58 V DC	
Output voltage		
Output current min.	0.5 mA	
Output current max.	30 mA	
Output leakage current at U _{max}	< 50 µA	
Residual voltage at I max and U rated	typical	2.3 V DC
	max	2.7 V DC
Frequency on inductive load	2500 V RMS	
Isolation Input / Output	input / Output	

Temperature

Ambient temperature	storage	-40...+80 °C
	operating	See derating curve

Other characteristics

Body material	grey	UL 94 V0
Wire size	Solid wire	0.2 - 4 mm ² (24-12 AWG)
	Stranded wire	0.22 - 2.5 mm ² (24-12 AWG)
Rated wire size		2.5 mm ² (12 AWG)
Wire stripping length		9 mm (0.354 in)
Recommended screwdriver		3.5 mm (0.137 in)
Protection		IP20 NEMA1
Recommended torque		0.4-0.6 Nm (3.5-5.3 lb.in)
Approvals		us (pending), CE
Reference standards	CEI 947-7-1 / CEI 947-1 / CEI 1131-2 (in relevant parts) / CEI 60664-1 / CEM : IRC 1000-4-2, 3, 4, 5, 6.	

Derating curve

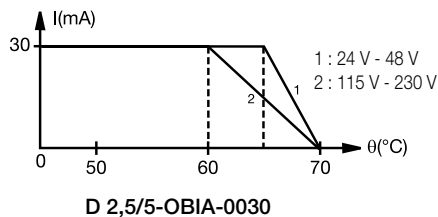

Dimensional drawings

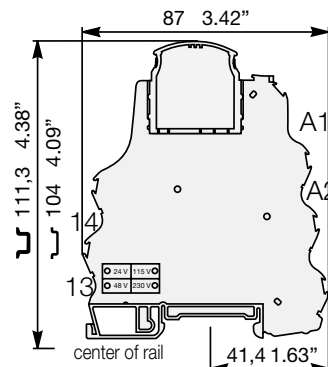

R500 Optocouplers

Technical data

Optocouplers
R600 & R500 Range

Technical data

Pluggable optocoupler : 5 to 58 V DC output / 100 mA - 5.08 mm 0.200" spacing

	D 2.5/5-OBIA-0100 5 V DC / 24 V DC		D 2.5/5-OBIA-0100 48 V DC
Input			
Input voltage	4.5 V to 5.5 V DC	20.4 V to 28.8 V DC	40.8 V to 57.6 V DC
Frequency			
Input current	8.5 mA	4.8 mA	3.9 mA
Pull-in voltage at $I_s=100\%$	2.9 V DC	16 V DC	26 V DC
Switching time C / O		20 μ s / 1.3 ms	
Operating frequency		400 Hz	
Permissible leakage current		1 mA	
Output			
Output voltage		4.5 V to 58 V DC	
Output current min.		1 mA	
Output current max.		100 mA	
Output leakage current at U_{max}		< 50 μ A	
Residual voltage at I_{max} and U rated	typical	1 V DC	
	max	1.3 V DC	
Frequency on inductive load		See Note 1	
Isolation Input / Output	input / Output	2500 V RMS	
Temperature			
Ambient temperature	storage	-40...+80 °C	
	operating	See derating curve	
Other characteristics			
Body material	grey	UL 94 V0	
Wire size	Solid wire	0.2 - 4 mm ² (24-12 AWG)	
	Stranded wire	0.22 - 2.5 mm ² (24-12 AWG)	
Rated wire size		2.5 mm ² (12 AWG)	
Wire stripping length		9 mm (0.354 in)	
Recommended screwdriver		3.5 mm (0.137 in)	
Protection		IP20 NEMA1	
Recommended torque		0.4-0.6 Nm (3.5-5.3 lb.in)	
Approvals		cULus (pending), CE	
Reference standards		CEI 947-7-1 / CEI 947-1 / CEI 1131-2 (in relevant parts) / CEI 60664-1 / CEM : IRC 1000-4-2, 3, 4, 5, 6.	

Note 1 :

$$F_{max} = (1 - 0,007 \times U_s) / (L \times I_s^2)$$

or

$$F_{max} = (1 - 0,007 \times U_s) / (P \times \frac{L}{R})$$

- U_s = Output voltage
- I_s = Output current
- L = Inductance of load
- P = Power of load
- R = Resistance of load

Derating curve

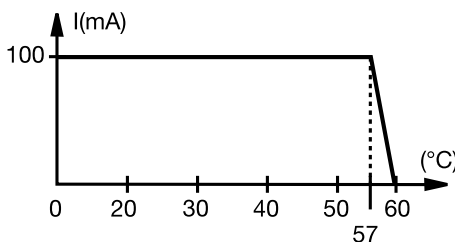

D 2.5/5-OBOC-0100 5 V DC / 24 V DC

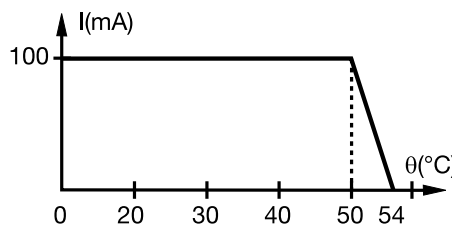

D 2.5/5-OBOC-0100 48 V DC

Dimensional drawings

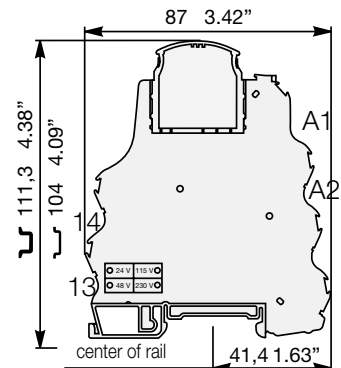

R500 Optocouplers

Technical data

Technical data



Pluggable optocoupler : 5 to 58 V DC output / 1 A - 5.08 mm 0.200" spacing

6

Input	D 2.5/5-OBOC-1000 5/24 V DC		D 2.5/5-OBOC-1000 24/48 V AC/DC				D 2.5/5-OBOC-1000 110/230 V AC	
	5 V DC	24 V DC	24 V AC	24 V DC	48 V AC	48 V DC	110 V AC	230 V AC
Input voltage	4.5 - 5.5 V DC	20.4 - 28.8 V DC	24 ± 10 %	20.4 - 28.8 V DC	48 ± 10 %	40.8 to 57.6 V DC	110 ± 10 %	230 ± 10 %
Frequency			50 / 60 Hz		50 / 60 Hz		50 / 60 Hz	50 / 60 Hz
Input current	12.3 mA	6.7 mA	10.5 mA	8 mA	6.8 mA	5.8 mA	8.5 mA	7.5 mA
Pull-in voltage at $I_s=100\%$	3.5 V DC	10 V DC						
Switching time C / O	20 / 250 µs	50 / 350 µs	15 / 13 ms	5 / 13 ms	15 / 15 ms	6 / 25 ms	15 / 15 ms	15 / 15 ms
Operating frequency	2000 Hz	1500 Hz				20 Hz		
Permissible leakage current								

Output		
Output voltage		4.5 V to 58 V DC
Output current min.		1 mA
Output current max.		1 A
Output leakage current at U_{max}		< 50 µA
Residual voltage at I_{max} and U rated	typical	0.1 V DC
	max	0.5 V DC
Frequency on inductive load		See Note 1
Isolation Input / Output	input / Output	2500 V RMS

Temperature		
Ambient temperature	storage	-40...+80 °C
	operating	See derating curve

Other characteristics		
Body material	grey	UL 94 V0
Wire size	Solid wire	0.2 - 4 mm ² (24-12 AWG)
	Stranded wire	0.22 - 2.5 mm ² (24-12 AWG)
Rated wire size		2.5 mm ² (12 AWG)
Wire stripping length		10 mm (0.394 in)
Recommended screwdriver		3.5 mm (0.137 in)
Protection		IP20 NEMA1
Recommended torque		0.4-0.6 Nm (3.5-5.3 lb.in)
Approvals		 us (pending), 
Reference standards		CEI 947-7-1 / CEI 947-1 / CEI 1131-2 (in relevant parts) / CEI 60664-1 / CEM : IRC 1000-4-2, 3, 4, 5, 6.

Note 1 :

$F_{max} = (1 - 0.007 \times U_s) / (L \times I_s^2)$
 or
 $F_{max} = (1 - 0.007 \times U_s) / (P \times \frac{L}{R})$

- U_s = Output voltage
- I_s = Output current
- L = Inductance of load
- P = Power of load
- R = Resistance of load

Derating curve

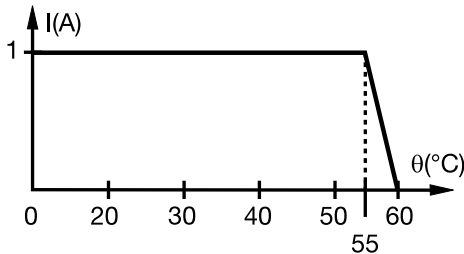

Dimensional drawings

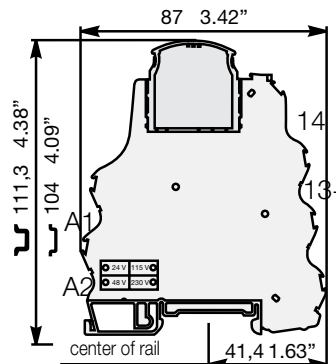

R500 Optocouplers

Technical data

Technical data

Pluggable optocoupler : 5 to 30 V DC output / 2 A - 5.08 mm 0.200" spacing

	D 2.5/5-OBOC-2000 5/24 V DC		D 2.5/5-OBOC-2000 24/48 V AC/DC				D 2.5/5-OBOC-2000 110/230 V AC	
	5 V DC	24 V DC	24 V AC	24 V DC	48 V AC	48 V DC	110 V AC	230 V AC
Input voltage	4.5 - 5.5 V DC	20.4 - 28.8 V DC	24 ± 10 %	20.4 - 28.8 V DC	48 ± 10 %	40.8 to 57.6 V DC	110 ± 10 %	230 ± 10 %
Frequency			50 / 60 Hz		50 / 60 Hz		50 / 60 Hz	50 / 60 Hz
Input current	12.3 mA	6.7 mA	10.5 mA	8 mA	6.8 mA	5.8 mA	8.5 mA	7.5 mA
Pull-in voltage at Is=100%	3.5 V DC	10 V DC						
Switching time C / O	20 / 250 µs	50 / 350 µs	15 / 13 ms	5 / 13 ms	15 / 15 ms	6 / 25 ms	15 / 15 ms	15 / 15 ms
Operating frequency	2000 Hz	1500 Hz			20 Hz			
Permissible leakage current								

Output

Output voltage	4.5 V to 58 V DC	
Output current min.	1 mA	
Output current max.	2 A	
Output leakage current at U _{max}	< 50 µA	
Residual voltage at I max and U rated	typical	0.1 V DC
	max	0.5 V DC
Frequency on inductive load	See Note 1	
Isolation Input / Output	input / Output	2500 V RMS

Temperature

Ambient temperature	storage	-40...+80 °C
	operating	See derating curve

Other characteristics

Body material	grey	UL 94 V0
Wire size	Solid wire	0.2 - 4 mm ² (24-12 AWG)
	Stranded wire	0.22 - 2.5 mm ² (24-12 AWG)
Rated wire size		2.5 mm ² (12 AWG)
Wire stripping length		10 mm (0.394 in)
Recommended screwdriver		3.5 mm (0.137 in)
Protection		IP20 NEMA1
Recommended torque		0.4-0.6 Nm (3.5-5.3 lb.in)
Approvals		us (pending), CE
Reference standards	CEI 947-7-1 / CEI 947-1 / CEI 1131-2 (in relevant parts) / CEI 60664-1 / CEM : IRC 1000-4-2, 3, 4, 5, 6.	

Note 1 :

$$F_{max} = (1 - 0,012 \times U_s) / (L \times I_s^2)$$

or

$$F_{max} = (1 - 0,012 \times U_s) / (P \times \frac{L}{R})$$

U_s = Output voltage

I_s = Output current

L = Inductance of load

P = Power of load

R = Resistance of load

Derating curve

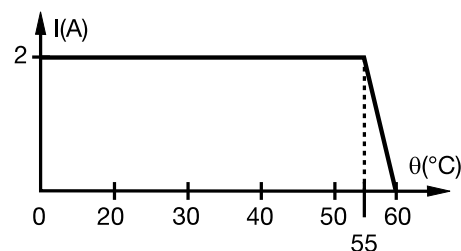

Dimensional drawings

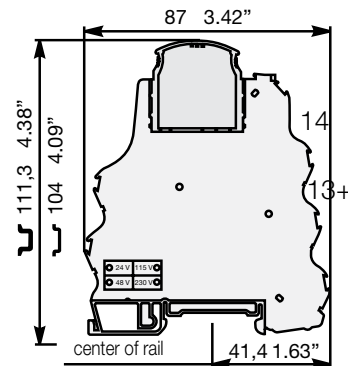

R500 Optocouplers

Technical data

Technical data

Pluggable optocoupler : 24 to 253 V AC output / 1 A - 5.08 mm 0.200" spacing

	D 2.5/5-... 24 V DC	D 2.5/5-OBOA-1000 24 V AC/DC - 48 V AC/DC				D 2.5/5-OBOA-1000 110 V AC - 230 V AC	
Input	24 V DC	24 V AC	24 V DC	48 V AC	48 V DC	110 V AC	230 V AC
Input voltage	20.4 - 28.8 V DC	24 ± 10 %	20.6 - 28.8 V DC	48 ± 10 %	40.8 - 57.6 V DC	110 ± 10 %	230 ± 10 %
Frequency		50 / 60 Hz		50 / 60 Hz		50 / 60 Hz	50 / 60 Hz
Input current	4 mA	10 mA	7 mA	6 mA	5 mA	8 mA	7.5 mA
Pull-in voltage at Is=100%							
Switching time C / O	10/20 ms	20/20 ms	10/20 ms	20/20 ms	10/20 ms	20/20 ms	20/20 ms
Operating frequency				15 Hz			
Permissible leakage current							

Output	
Output voltage	24-253 V AC - 50/60 Hz
Output current min.	25 mA
Output current max.	1 A
Output leakage current at U _{max}	< 0.50 mA
Residual voltage at I max and U rated	typical 1 V max 1.6 V
Frequency on inductive load	See Note 1
Isolation Input / Output	input / Output 2500 V RMS

Temperature	
Ambient temperature	storage -40...+80 °C operating See derating curve

Other characteristics	
Body material	grey UL 94 V0
Wire size	Solid wire 0.2 - 4 mm ² (24-12 AWG) Stranded wire 0.22 - 2.5 mm ² (24-12 AWG)
Rated wire size	2.5 mm ² (12 AWG)
Wire stripping length	10 mm (0.394 in)
Recommended screwdriver	3.5 mm (0.137 in)
Protection	IP20 NEMA1
Recommended torque	0.4-0.6 Nm (3.5-5.3 lb.in)
Approvals	us (pending), CE
Reference standards	CEI 947-7-1 / CEI 947-1 / CEI 1131-2 (in relevant parts) / CEI 60664-1 / CEM : IRC 1000-4-2, 3, 4, 5, 6.

Note 1 :
 $F_{max} = (1 - 0.012 \times U_s) / (L \times I_s^2)$
 or
 $F_{max} = (1 - 0.012 \times U_s) / (P \times \frac{L}{R})$
 Us = Output voltage
 Is = Output current
 L = Inductance of load
 P = Power of load
 R = Resistance of load

Derating curve

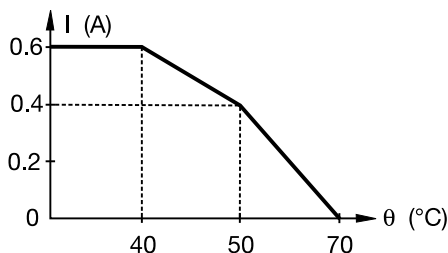

Dimensional drawings

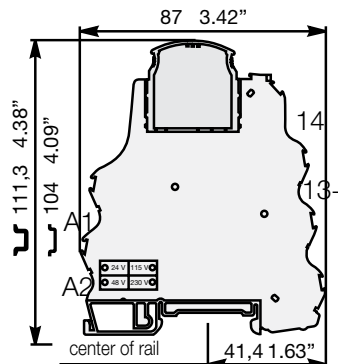



Accessories

Interface relays & optocouplers

Terminal blocks component holder

Base for pluggable plug
R500 Series

DIN 3

End stop		th. 9 mm	BADL	V0	039990302
End stop		th. 9 mm	BAM2	V0	039996701
Rail		35 x 7.5 x 1	PR30		017322005
Rail		35 x 15 x 2.3	PR4		016850012
Rail		35 x 15 x 1.5	PR5		016870022

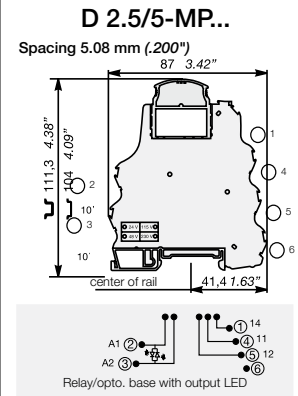
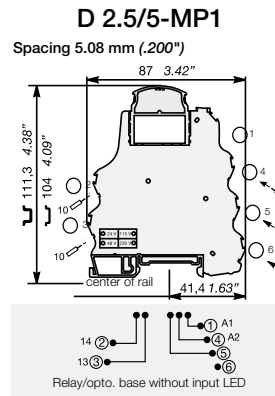
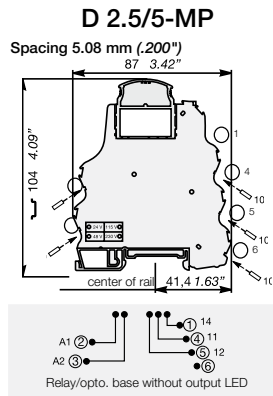

Observations

Terminal blocks are delivered without plugs.

Max. working temperature
version without LED : 100°C
version with LED : 85°C
Contact resistance : < 5 mΩ

Ref. Code	Catalog No.	Ref. Code	Catalog No.	Ref. Code	Catalog No.
Grey V0	Order plugs separately	Grey V0	Order plugs separately	Grey V0	Order plugs separately
D 2.5/5-MP	1SNA607224R0100	D 2.5/5-MP1	1SNA607223R0000	D 2.5/5-MP-24VDC	1SNA607222R0700
				D 2.5/5-MP-24VAC/DC	1SNA607260R2100
				D 2.5/5-MP-48VAC/DC	1SNA607261R1600
				D 2.5/5-MP-110VAC	1SNA607266R1300
				D 2.5/5-MP-230VAC	1SNA607267R1400

Characteristics

			IEC	UL/CSA pending	IEC	UL/CSA pending	IEC	UL/CSA pending
Wire size	Compression clamp	Solid wire	0.2-4 mm ²	24-12 AWG	0.2-4 mm ²	24-12 AWG	0.2-4 mm ²	24-12 AWG
		Stranded wire	0.22-2.5 mm ²	24-12 AWG	0.22-2.5 mm ²	24-12 AWG	0.22-2.5 mm ²	24-12 AWG
Voltage	Rated		320 V	300 V	320 V	300 V	320 V	300 V
	Pulse		4 kV		4 kV		4 kV	
	Pollution degree		3		3		3	
Current	Rated		6 A	6 A	6 A	6 A	6 A	6 A
Wire size	Rated / Gauge		2.5 mm ²	12 AWG	2.5 mm ²	12 AWG	2.5 mm ²	12 AWG
Wire stripping length			10 mm / .394"		10 mm / .394"		10 mm / .394"	
Recommended screwdriver			3.5 mm / .137"		3.5 mm / .137"		3.5 mm / .137"	
Recommended torque			0.4-0.6 Nm / 3.5-5.3 lb.in		0.4-0.6 Nm / 3.5-5.3 lb.in		0.4-0.6 Nm / 3.5-5.3 lb.in	
Protection			IP 20 / NEMA1		IP 20 / NEMA1		IP 20 / NEMA1	

Accessories

	Ref. Code	Catalog No.	Ref. Code	Catalog No.	Ref. Code	Catalog No.
1 Test device	DCB (1)	blue 010502821	DCB (1)	blue 010502821	DCB (1)	blue 1SNA105028R2100
2 Test plug	FC2	DIA. 2 000786526	FC2	DIA. 2 010502821	FC2	DIA. 2 1SNA007865R2600
3 Relay plug 1 SPDT 10 mA/6 A 1 SPDT 1 mA/6 A	BNMS R24V-1	beige 1SNA031820R1400	BNMS R24V-1	beige 000786526	BNMS R24V-1	beige 1SNA031820R1400
	BNMS R24V-2	beige 1SNA031847R1300			BNMS R24V-2	beige 1SNA031847R1300
4 Input optocoupler plug 5 V DC 24 V DC 24 V DC 48 V DC 125 V DC 24 V AC 48 V AC 115 V AC 230 V AC	BNMS N24V-3	red 1SNA031807R1400	BNMS T5V-1	white 003183103	BNMS N24V-3	red 1SNA031807R1400
	BNMS P24V-3	red 1SNA031810R1200	BNMS T24V-1	white 1SNA031848R2400	BNMS P24V-3	red 1SNA031810R1200
	BNMS N24V-1	red 1SNA031813R0100	BNMS T24V-2	white 003180021	BNMS N24V-1	red 1SNA031813R0100
	BNMS P24V-1	red 1SNA031815R0300	BNMS T48V-1	white 1SNA031801R1600	BNMS P24V-1	red 1SNA031815R0300
	BNMS N24V-2	red 1SNA031817R0500	BNMS T125V-1	white 1SNA031845R1100	BNMS N24V-2	red 1SNA031817R0500
	BNMS P24V-2	red 1SNA031819R1700	BNMS T24V-1	yellow 003180217	BNMS P24V-2	red 1SNA031819R1700
	BNMS A24V-4	black 003183913	BNMS T48V-1	yellow 1SNA031803R1000	BNMS A24V-4	black 003183913
5 Output optocoupler 5 V DC/100 mA 5 V DC/100 mA 48 V DC/100 mA 48 V DC/100 mA	BNMS N5V-3	red 1SNA031806R1300	BNMS T115V-1	yellow 003180411	BNMS N5V-3	red 1SNA031806R1300
	BNMS P5V-3	red 1SNA031809R2600	BNMS T230V-1	yellow 1SNA031805R1200	BNMS P5V-3	red 1SNA031809R2600
	BNMS N48V-3	red 1SNA031808R2500			BNMS N48V-3	red 1SNA031808R2500
	BNMS P48V-3	red 1SNA031811R0700			BNMS P48V-3	red 1SNA031811R0700
	BNMS N5V-1	red 1SNA031812R0000			BNMS N5V-1	red 1SNA031812R0000
	BNMS P5V-1	red 1SNA031814R0200			BNMS P5V-1	red 1SNA031814R0200
	BNMS N5V-2	red 1SNA031816R0400			BNMS N5V-2	red 1SNA031816R0400
	BNMS P5V-2	red 1SNA031818R1600			BNMS P5V-2	red 1SNA031818R1600
7 Fuse plug 125 V/125 mA 125 V/500 mA 125 V/2 A 125 V/5 A 250 V/125 mA 250 V/2 A 250 V/5 A 125 V/125 mA 250 V/125 mA 125 V/2 A	BNMS F125mA-1	grey 003182101	BNMS F125mA-1	grey 003182101	BNMS F125mA-1	grey 003182101
	BNMS F500mA-1	grey 003183812	BNMS F500mA-1	grey 003183812	BNMS F500mA-1	grey 003183812
	BNMS F2A-1	grey 003182202	BNMS F2A-1	grey 003182202	BNMS F2A-1	grey 003182202
	BNMS F5A-1	grey 003182303	BNMS F5A-1	grey 003182303	BNMS F5A-1	grey 003182303
	BNMS F125mA-2	grey 1SNA031824R0400	BNMS F125mA-2	grey 1SNA031824R0400	BNMS F125mA-2	grey 1SNA031824R0400
	BNMS F2A-2	grey 003182505	BNMS F2A-2	grey 003182505	BNMS F2A-2	grey 003182505
	BNMS F5A-2	grey 1SNA031826R0600	BNMS F5A-2	grey 1SNA031826R0600	BNMS F5A-2	grey 1SNA031826R0600
	BNMS F125mA-3	grey 003182707			BNMS F125mA-3	grey 1SNA031827R0700
	BNMS F125mA-4	grey 003182810			BNMS F125mA-4	grey 1SNA031828R1000
	BNMS F2A-7	grey 1SNA031849R2500	BNMS F2A-7	grey 1SNA031849R2500		
8 Strap plug	BNMS ST1	grey 003182911	BNMS ST1	grey 003182911	BNMS ST1	grey 003182911
	BNMS ST2	grey 003183016	BNMS ST2	grey 003183016		
9 Converter plug 0-20 mA/0-10 V 4-20 mA/2-10 V 0-20 mA/0-5 V 4-20 mA/1-5 V	BNMS CAI/U-500	grey 1SNA031832R0400				
	BNMS CAI/U-500	grey 1SNA031832R0400				
	BNMS CAI/U-250	grey 1SNA031833R0500				
	BNMS CAI/U-250	1SNA031833R0500				
10 Comb type jumper bar 10 poles	PCMS V0 (2)	1SNA205523R2200	PCMS V0 (2)	1SNA205523R2200	PCMS V0 (2)	1SNA205523R2200
R See section on marking	RC 55		RC 55		RC 55	

(1) Solely on the top stage. (2) Comb type jumper bar from 2 to 22 poles, see accessories.

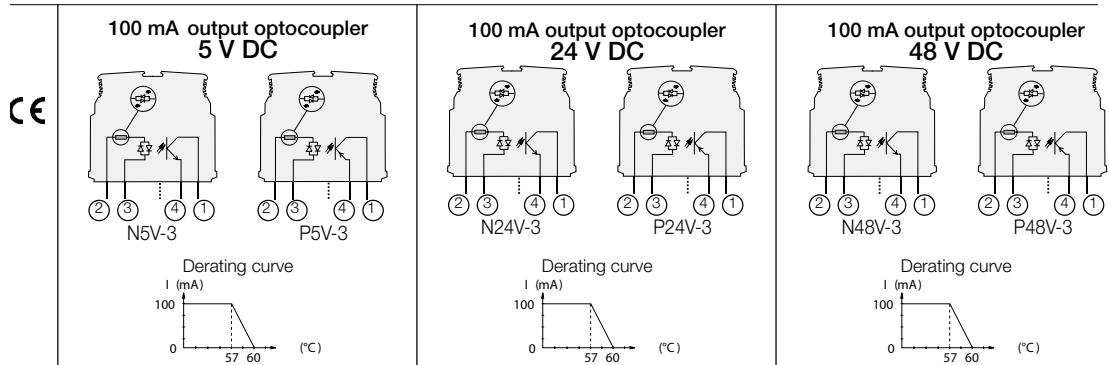
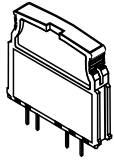

Part numbers	Ref. Code	Cat. No.	Ref. Code	Cat. No.	Type	Cat. No.
	BNMS N5V-3	1SNA031806R1300	BNMS N24V-3	1SNA031807R1400	BNMS N48V-3	1SNA031808R2500
	BNMS P5V-3	1SNA031809R2600	BNMS P24V-3	1SNA031810R1200	BNMS P48V-3	1SNA031811R0700

6 Characteristics

INPUT							
Voltage	4.5 V to 5.5 V DC		20.4 V to 28.8 V DC		40.8 V to 57.6 V DC		
Max. current	8.5 mA		4.8 mA		3.9 mA		
Typical triggering threshold at $I_s = 100\%$	2.9 V DC		16 V DC		26 V DC		
Switching time	C/O	20 μ s / 1.3 ms		20 μ s / 1.3 ms		20 μ s / 1.3 ms	
Leakage current	1 mA		1 mA		1 mA		
OUTPUT							
Max. voltage / Max. current	58 V / 100 mA		58 V / 100 mA		58 V / 100 mA		
Residual voltage max. I and rated U							
standard U	1 V DC		1 V DC		1 V DC		
max.	1.3 V DC		1.3 V DC		1.3 V DC		
Frequency on inductive load	See Note 1		See Note 1		See Note 1		
Input / Output isolation	2,5 kV		2,5 kV		2,5 kV		
TEMPERATURE							
Storage	- 30°C to + 80°C		- 30°C to + 80°C		- 30°C to + 80°C		
Operating	- 20°C to + 60°C		- 20°C to + 60°C		- 20°C to + 60°C		

MOS output optocoupler plugs

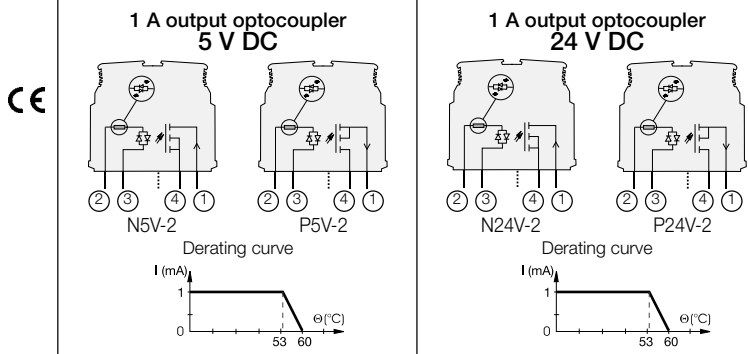
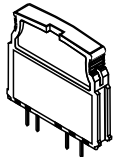

Note 1 :
 $F_{max} = (1 - 0,007 \times U_s) / (L \times I_s^2)$
 or
 $F_{max} = (1 - 0,007 \times U_s) / (P \times \frac{1}{R})$

U_s = Output voltage supply
 I_s = Output current
 L = Inductive load
 P = Load power
 R = Load resistance

Part numbers	Ref. Code	Cat. No.	Ref. Code	Cat. No.
	BNMS N5V-2	1SNA031816R0400	BNMS N24V-2	1SNA031817R0500
	BNMS P5V-2	1SNA031818R1600		

Characteristics					
INPUT					
Voltage	4.5 V to 5.5 V DC		20.4 V to 28.8 V DC		
Max. current	12.5 mA		6.7 mA		
Typical triggering threshold at $I_s=100\%$	3.5 V DC		10 V DC		
Switching time	C/O	20 μ s / 250 μ s		50 μ s / 350 μ s	
Leakage current	1 mA		1 mA		
OUTPUT					
Max. voltage / Max. current	58 V / See graphs		58 V / See graphs		
Residual voltage max. I and rated U					
standard U	1 V DC		1 V DC		
max.	1.3 V DC		1.3 V DC		
Frequency on inductive load	See Note 1		See Note 1		
Input / Output isolation	2,5 kV		2,5 kV		
TEMPERATURE					
Storage	- 30°C to + 80°C		- 30°C to + 80°C		
Operating	- 20°C to + 60°C		- 20°C to + 60°C		

MOS output optocoupler plug

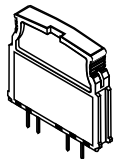

2 A output optocoupler 5 V DC

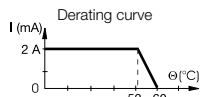
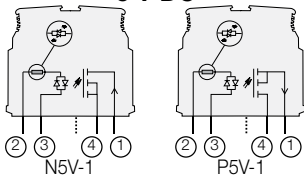

2 A output optocoupler 24 V DC

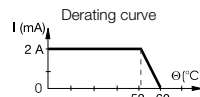
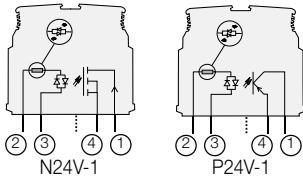

Note 2 :

$$F_{max} = (1 - 0.012 \times U_s) / (L \times I_s^2)$$

or

$$F_{max} = (1 - 0.012 \times U_s) / (P \times \frac{L}{R})$$

U_s = Output voltage supply
 I_s = Output current
 L = Inductive load
 P = Load power
 R = Load resistance

Part numbers

Ref. Code	Cat. No.	Ref. Code	Cat. No.
BNMS N5V-1	1SNA031812R0000	BNMS N24V-1	003181301
BNMS P5V-1	003181402	BNMS P24V-1	003181503

Characteristics

INPUT

Parameter	5 V DC	24 V DC
Voltage	4.5 V to 5.5 V DC	20.4 V to 28.8 V DC
Max. current	12.5 mA	6.7 mA
Typical triggering threshold	3.5 V DC	10 V DC
Switching time C/O	20 μs / 250 μs	50 μs / 350 μs
Leakage current	1 mA	1 mA

OUTPUT

Parameter	5 V DC	24 V DC
Max. voltage / Max. current	30 V DC / See graphs	30 V / See graphs
Residual voltage max. I and rated U		
standard U	1 V DC	1 V DC
max.	1.3 V DC	1.3 V DC
Frequency on inductive load	See Note 2	See Note 2
Input / Output isolation	2.5 kV	2.5 kV

TEMPERATURE

Temperature	5 V DC	24 V DC
Storage	-30°C to +80°C	-30°C to +80°C
Operating	-20°C to +60°C	-20°C to +60°C

Triac output optocoupler plug

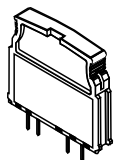

1 A output optocoupler 24 V DC

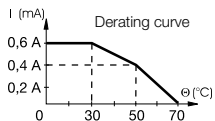
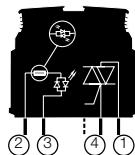

Part numbers

Ref. Code	Cat. No.
BNMS A24V-4	003183913

Characteristics

INPUT

Parameter	24 V DC
Voltage	20.4 V to 28.8 V DC
Max. current	3.8 mA
Typical triggering threshold	10 V DC
Switching time C/O	9.5 ms / 12 ms
Leakage current	

OUTPUT

Parameter	24 V DC
Max. voltage / Max. current	24 V to 253 V AC / See derating curve
Residual voltage max. I and rated U	
standard U	1 V AC
max.	1.3 V AC
Input / Output isolation	2.5 kV

TEMPERATURE

Temperature	24 V DC
Storage	-30°C to +80°C
Operating	-20°C to +70°C

Relay plugs

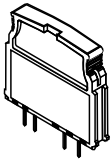

1 SPDT relay

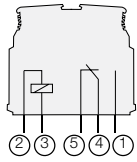

R24V-1

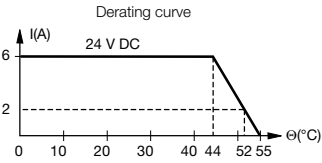

Part numbers

Ref. Code	Cat. No.
BNMS R24V-1	1SNA031820R1400
BNMS R24V-2	1SNA031847R1300

Characteristics

	BNMS R24V-1	BNMS R24V-2
COIL		
Voltage	20.4 V to 28.8 V DC	
Current max.	7 mA	
Trip voltage	1.2 V	
CONTACT		
Type	1 SPDT	
Voltage mini. / max.	12 V / 250 V	5 V / 250 V
Switching current mini. / max.	10 mA / 6 A	1 mA / 6 A
Switching current AC1 mini. / max.	0,6 VA/1500 VA (resistance)	0,05 VA/1500 VA (resistance)
DC1 mini. / max.	0,6 W / 140 W	0,05 W / 140 W
Number of operations on load	10 ⁶ operations for AC15	
Number of operations off load	10x10 ⁶ operations	
Operating speed C/O	6 ms / 8 ms	
Bounce	1,5 ms	
Isolation Coil / Contact	4 kV	
Resistance to shock waves Coil / Contact	4 kV	
Isolation Contact / Contact	1 kV	
TEMPERATURE		
Storage	- 40°C to + 80°C	
Operating	- 20°C to + 55°C	

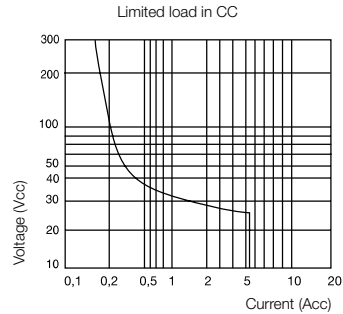

	DC12	AC12	DC13	AC15
24 V	6 A	6 A	1 A	3 A
110/120 V	0.3 A	6 A	0.2 A	3 A
220/230 V	0.2 A	6 A	0.1 A	3 A

Analogical plugs

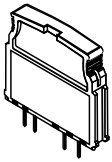

Current / Voltage Converter

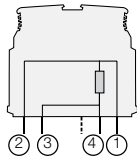

Plug with 250 Ω accuracy resistance for analogical signals.

Current / Voltage Converter

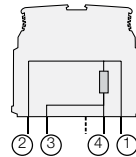

Plug with 500 Ω accuracy resistance for analogical signals.

Part numbers

Ref. Code	Cat. No.	Ref. Code	Cat. No.
BNMS CA I/U-250	1SNA031832R0400	BNMS CA I/U-500	1SNA031833R0500

Characteristics

	250 Ω	500 Ω
Resistance	250 Ω	500 Ω
Power	0.35 W	0.35 W
Accuracy	0.1 %	0.1 %
Stability	25 ppm	25 ppm

Fuse and strap plugs

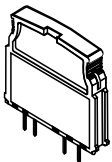

Output fuse plug

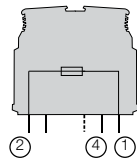

Input fuse plug

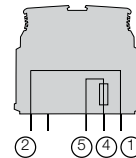

Strap plug

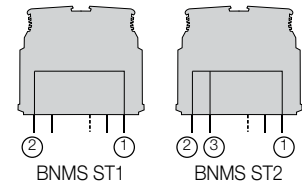

Part numbers

Ref. Code	Cat. No.	Ref. Code	Cat. No.	Ref. Code	Cat. No.
BNMS F125mA-1	125 V / 125 mA	003182101	BNMS F125mA-3	125 V / 125 mA	003182707
BNMS F500mA-1	125 V / 500 mA	003183812	BNMS F125mA-4	250 V / 125 mA	003182810
BNMS F2A-1	125 V / 2 A	003182202			
BNMS F5A-1	125 V / 5 A	003182303			
BNMS F125mA-2	250 V / 125 mA	1SNA031824R0400			
BNMS F2A-2	250 V / 2 A	003182505			
BNMS F5A-2	250 V / 5 A	1SNA031826R0600			
				BNMS ST1	003182911
				BNMS ST2	003183016

End stops

The end stops are mounted at the extremity of the terminal board assembly, giving additional support to the terminal blocks as markers. For various types of marking, refer to the marker section.

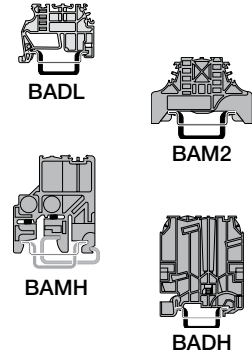

Description	Ref. Code	Catalog number	Packaging Weight kg
End stop DIN 3	BADL 9 mm	039990302	50
End stop with screws DIN 3	grey BAM2 10 mm	039995701	50
	light grey BAM2 10 mm	020635116	50
	beige BAM2 10 mm	029635100	50
High end stop with screws DIN 1 and DIN 3	grey BAMH 9.1 mm	011483600	50
	beige BAMH 9.1 mm	019483601	50
High end stop with screws DIN 3	grey BADH 12 mm	011690027	50

Mounting rails

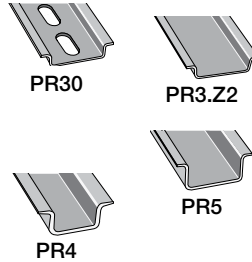

Symmetrical white passivated galvanized steel prepunched rail	PR30 2 m	017322005	1
Symmetrical white passivated galvanized steel rail	PR3.Z2 2 m	017430017	1
Symmetrical white passivated galvanized steel rail	PR5 2 m	016870022	1
Symmetrical white passivated galvanized steel rail	PR4 2 m	016850012	1

Test devices



Test plug DIA. 2 mm	FC2	1SNA007865R2600	10
---------------------	-----	-----------------	----

Assembled jumper bar

This accessory permits electrical connection between 2 to 70 blocks with 6 mm spacing placed side by side. It can be used with screw clamp or spring clamp blocks with 6 mm or 12 mm spacing. Interconnection of blocks not placed side by side is possible if teeth of the jumper bar have been cut in front of the blocks not to be connected. These teeth can be removed using pliers. Use of separator end sections before and after the jumper bar is required to preserve IP20 protection of the assembly.

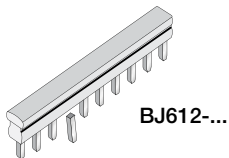

Assembled jumper bar 10 poles - 24 A	BJ612-10	029048801	10
--------------------------------------	----------	-----------	----

Separator end section

Directly mounted on the rail beside the block, it permits to identify and make electrical insulation of product groups using jumper bars. Dimensions are the same as screw clamp blocks : width 70 mm and height on rail 67.5 mm with 2 mm spacing.

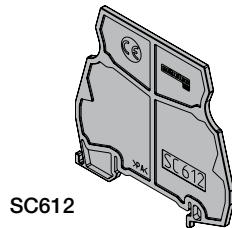

Separator end section	SC612	1SNA290474R0200	10
-----------------------	-------	-----------------	----

Distribution module

This terminal block with BJ612-... jumper bars permits 2 polarities distribution (*PCL side and process side*) thanks to two separate circuits, each of them including :

- one 4 mm² input,
- two 2,5 mm² outputs
- one double output for jumper bar BJ612-...

It permits also the connection of ground to the rail through a 4 mm² input.

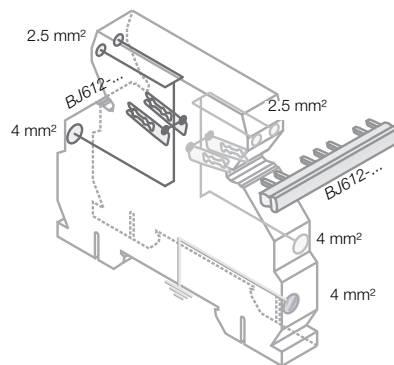
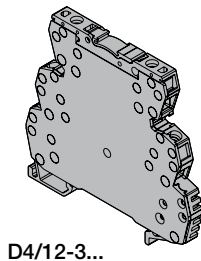

Rated voltage : 250 VAC-DC
 Rated current : 32 A (4 mm²) - 16 A (2,5 mm²)
 Recommended torque : 0.4 - 0.6 Nm

Screw clamp distribution block sp. 12 mm	D4/12-3-3	1SNA645031R2000	5
Spring clamp distribution block sp. 12 mm	D4/12-3R-3R	1SNA645531R2200	5

Accessories

PCMS

Comb-type jumper

This accessory permits the electrical connection of 2 to 22 blocks.

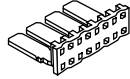

No. of poles	Grey UL94V0	Red UL94V0	Blue UL94V0	Green/Yellow UL94V0
2	1SNA205491R2300	1SNA205492R2400	1SNA205493R2500	-
3	1SNA205495R2700	-	-	-
4	1SNA205499R0300	1SNA205500R1000	1SNA205501R0500	-
5	1SNA205503R0700	1SNA205504R0000	1SNA205505R0100	-
6	1SNA205507R0300	1SNA205508R1400	1SNA205509R1500	-
7	1SNA205511R2600	-	-	-
8	1SNA205515R2200	-	-	-
9	1SNA205519R0600	-	-	-
10	1SNA205523R2200	1SNA205524R2300	1SNA205525R2400	1SNA205526R2500
11	1SNA205527R2600	-	-	-
12	1SNA205531R2200	1SNA205532R2300	1SNA205533R2400	1SNA205534R2500
13	1SNA205535R2600	-	-	-
14	1SNA205539R0200	-	-	-
15	1SNA205543R0600	-	-	-
16	1SNA205547R0200	1SNA205548R1300	1SNA205549R1400	1SNA205550R1100
17	1SNA205551R0600	-	-	-
18	1SNA205555R0200	-	-	-
19	1SNA205559R1600	-	-	-
20	1SNA205563R0200	1SNA205564R0300	1SNA205565R0400	1SNA205566R0500
21	1SNA205567R0600	-	-	-
22	1SNA205571R0200	-	-	-

6

DC

Test device on screw head

This patented device is mounted on the round screwdriver opening. It is used for trouble shooting, measuring and control for monitoring and repairing an installation, on blocks without a test socket. For this, the device receives an **FC2** test plug.



The DC's are differentiated by their colour :

blue for **MA 2.5/5** blocks

DCB 010502821

BJ Jumper bar

BJS Jumper bar not assembled

To connect terminal blocks, place the metal tube into the top center hole on each terminal block to be connected.

The metal tube contacts the terminal block's internal connector bar.

To be mounted on blocks series R910 :

Screw + washer + post **EV6D** 1SNA168400R1600



PC

Comb-type jumper bar

PC **EIP**

This accessory can be used only on the terminal blocks with at least one compression clamp connection. It permits the electrical connection of 2 to 10 blocks.

Interconnection of non-consecutive blocks is possible by removing the teeth opposite the blocks which must not be connected. The comb-type jumper bars can be cut using pliers (or a saw) : in this case, the use of an insulating tip **EIP** is recommended. The comb is placed in the compression clamp before tightening the screws, above the eventual conductor.

To be mounted on blocks series R900 and R910 :

Insulating tip for comb **EIP** 011355024
Comb-type jumper bar **PC9** 15 A 10 poles 021016012

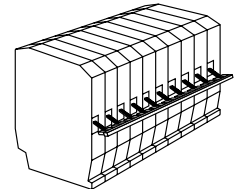

IDC jumper

(insulation displacement jumper)

Characteristics

Wire size mm ² / AWG	Rigid Flexible	IEC	CSA
		NFC VDE	
Voltage	V	600	600
	Current	A	26 15
Rated wire size	mm ² / AWG	2.5 mm ²	14 AWG
Working temperature	°C	-55°C -> +110°C	
Protection		IP20 / NEMA1	

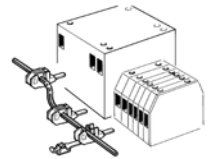
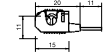
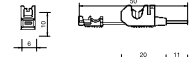

Quick-jump lets you interconnect screw clamp terminals of different sizes, levels and all manufacturers quickly and safely. Its insulation displacement technology makes it easy to use, fast, economical and does not require a special tool. Use as a jumper between relays, switches and other electronic components. ABB Quick-jump will fit any screw clamp type terminal block, from 6 mm .238" spacing and larger.

How to use : connecting Quick-jump to your terminal

- 1 - Insert ABB Quick-jump into your terminal screw clamp.
- 2 - Tighten the terminal screw.
- 3 - Guide jumper wire through the V-shaped opening in the Quick-jump.
- 4 - Secure the wire by closing the Quick-jump lever with any flat nose pliers.

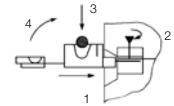

Adding a shunt in an installation :

- 1 - Insert ABB Quick-jump into your terminal screw clamp.
- 2 - Guide the terminal screw clamp into contact with the wire.
- 3 - Secure the wire by closing the Quick-jump lever with any flat nose pliers.
- 4 - Tighten the terminal screw.

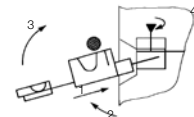

Insulation displacement jumper **AD 2.5** 011420520

Marking for Interface Modules

Selection table

Markers for modules :	RC610	RC55	RC65
R500	☐	●	☐
R600	●	POSSIBLE	●
R900	☐	●	☐
R910	●	POSSIBLE	●
R1800	☐	●	☐

Possible mounting : **POSSIBLE**

Recommended mounting : ●

Impossible mounting : ☐

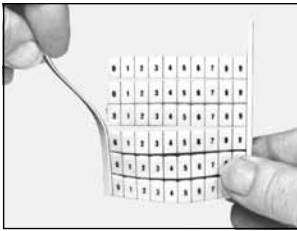

1

Remove one of the side bands of the card.

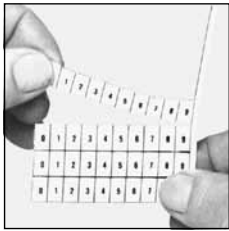

2

Separate the chosen strip from the rest of the card.

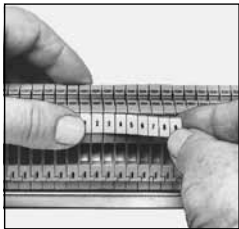

3

Press the first marker in place, hold it and slide your thumb on the rest of the strip.

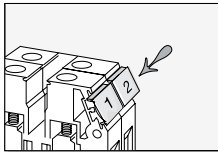

Horizontal marking

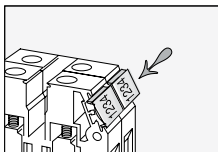

Vertical marking

Marking for terminal blocks

Standard RC marker cards

Marker sizes	RC55	RC65	RC610
Blank cards	023000012	023200000	023300001
Horizontal marking			
10 strips from 1 to 10	023000200 (5)	023200226 (5)	023300227 (25)
10 strips from 11 to 20	023000301 (2)	023200327 (2)	023300320 (10)
10 strips from 21 to 30	023000402	023200420	023300421 (6)
10 strips from 31 to 40	023000503	023200521	023300522 (4)
10 strips from 41 to 50	023000604	023200622	023300623 (3)
10 strips from 51 to 60	023000705	023200723	023300724 (2)
10 strips from 61 to 70	023000816	023200804	023300805 (2)
From 1 to 100	023003007 (2)	023203025 (2)	023303026 (15)
From 101 to 200	023003124	023203112	023303113 (2)
20 times L1-L2-L3-N-PE	023013125	023213113	023313114 (2)
Vertical marking			
10 strips from 1 to 10	023004106	023204124	023304125 (5)
10 strips from 11 to 20	023004207	023204225	023304226 (3)
10 strips from 21 to 30	023004300	023204326	023304327 (2)
10 strips from 31 to 40	023004401	023204427	023304420 (2)
From 1 to 100	023006015	023206003	023306004 (8)

(x) = Nb of cards in 5 mm spacing kit

(x) = Nb of cards in 6 mm spacing kit

(x) = Nb of cards in 6 mm spacing kit

Notes

6



Logic relays

Concept

CL range logic relays are suitable for small and medium-sized control tasks and are able to substitute logic wiring in a quick and simple manner.

They can be used for applications in control as well as for timing functions, e. g.

- in buildings, lighting systems, air-conditioning systems, general control functions,
- in small machines and systems or
- as stand-alone control module for small applications.

6 Steps to the application of CL range

- CL range can be used easily, rapidly and comfortably without any time-consuming planning and programming.
- The user can discover the advantages and the benefit of these logic relays in no time at all.
- CL range provides for the control statements according to a simple circuit diagram.
- Setup, storage, simulation and documentation are performed using the compact and user-friendly CL-SOFT software (CL-LAS.PS002).

Software characteristics (CL-SOFT)

- display on a PC monitor according to IEC, ANSI
- different languages to choose from
- easy installation on all Microsoft Windows™ operating systems

Technical Data overview

Logic relays

- 8 or 12 digital inputs
- 4 or 6 digital relay outputs
- optionally with 4 or 8 transistor outputs
- 128 rungs
- 3 contacts as n/o or n/c contacts in series plus 1 coil per rung
- optionally with 2 or 4 analog inputs (not 100-240 V AC version)
- power flow display for checking the circuit diagram (devices with display)
- expansions for local or remote level
- enclosure color RAL 7035
- DIN rail mounting

Display system

- usable as compact HMI logic relay
- fully graphic, backlit display module
- 12 digital inputs
- 4 digital relay outputs
- optionally with 4 transistor outputs
- 256 rungs
- 4 contacts as n/o or n/c contacts in series plus 1 coil per rung
- optionally with 4 analog inputs (not 100-240 V AC version)
- networking-compatible via CL-NET
- front panel mounting
- expansion for local

Logic links instead of wiring

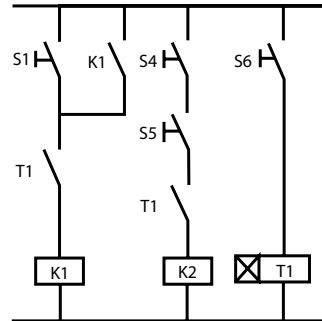

Documentation (download from the internet)

Logic relay manual	1SVC 440 795 M0100
Remote display manual	1SVC 440 795 M2100
Display system manual	1SVC 440 795 M1100

Remote display

- Remote display up to a distance of 5 m
- Illustration of text and status displays
- Remote adjustment via keypad
- Front panel mounting

Software

- 16 timing relays 0.01-99:59 h
- 16 counting relays for up-, down counting
- 8 weekly timer, 8 annual timers
- 16 analog value comparators
- 16 freely editable display texts
- 32 markers or auxiliary relays

Logic relays System overview

Logic relays

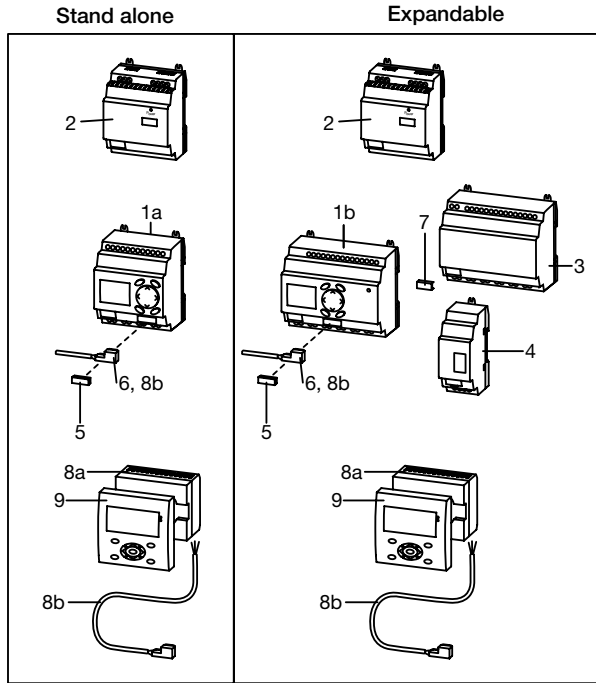

- 1a Logic relay CL-LS..
- 1b Expandable logic relay CL-LM..
- 2 Power supply CP-D...
- 3 I/O expansion CL-LER..., CL-LET.. for logic relays CL-LM..
- 4 Coupler unit CL-LEC.. for remote expansion of logic relays CL-LM..
- 5 Memory module CL-LAS.MD003 for logic relays CL-LS.., CL-LM..
- 6 Connecting cable CL-LAS.TK001, CL-LAS.TK002 to connect PC
- 7 CL-LINK plug CL-LAS.TK011 to connect expansion to logic relays CL-LM..
- 8a Remote display connection module CL-LDC.S..
- 8b Connecting cable CL-LAD.TK007 to connect a remote displays to a logic relay
- 9 Display module CL-LDD..

Expansion of logic relays*

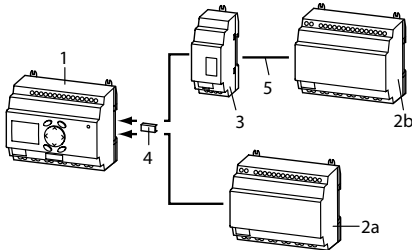

- 1 Logic relay CL-LM..
- 2 I/O expansion CL-LER..., CL-LET..
- 2a local expansion
- 2b remote expansion
- 3 Coupler unit CL-LEC.. for remote expansion of logic relays CL-LM..
- 4 CL-LINK plug CL-LAS.TK011 for expansion of logic relays CL-LM..
- 5 up to 30 m

* max. 1 expansion per logic relay

Display system → Compact HMI logic relay

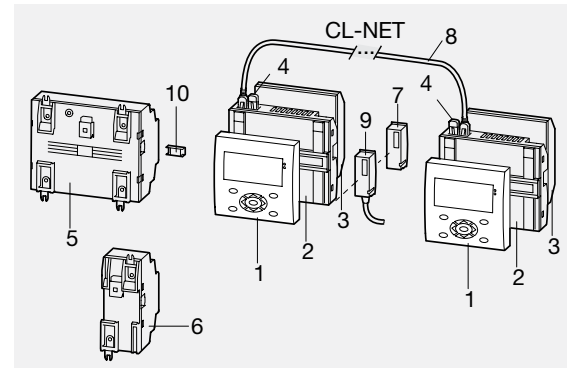

- 1 Display module CL-LDD..
- 2 Display base module CL-LDC.LN..
- 3 Display I/O module CL-LDR..., CL-LDT..
- 4 Termination resistor CL-LAD.TK009
- 5 I/O expansion CL-LER..., CL-LET..
- 6 Coupler unit CL-LEC.. for remote expansion
- 7 Memory module CL-LAD.MD004 for display base module
- 8 Connecting cable CL-LAD.TK002, CL-LAD.TK003, CL-LAD.TK004
- 9 Connecting cable CL-LAD.TK001, CL-LAD.TK011 to connect PC
- 10 CL-LINK plug CL-LAS.TK011 for expansion of logic relays CL-LM..
- e.g. door of switchgear cabinet

Stand alone with I/O module

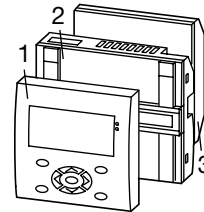





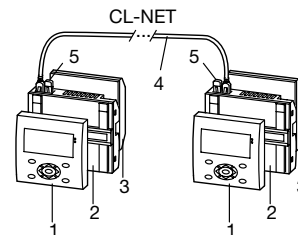



- 1 Display CL-LDD..
- 2 Remote display connection module CL-LDC.S.. incl. connecting cable
- 3 Display base module CL-LDC.L..

Communication via CL-NET



- 1 Display CL-LDD..
- 2 Display base module CL-LDC.LN.. for CL-NET
- 3 Display I/O module CL-LDR..., CL-LDT..
- 4 Connecting cable CL-LAD.TK002, CL-LAD.TK003, CL-LAD.TK004
- 5 Termination resistor CL-LAD.TK009

■ existing
□ pending

		Logic relays				Expansions			Display system				Accessories		
		CL-LSR	CL-LST	CL-LMR	CL-LMT	CL-LER	CL-LET	CL-LEC	CL-LDD	CL-LDC	CL-LDR	CL-LDT	CL-LAS	CL-LAD	
Approvals															
	UL	■	■	■	■	■	■	■	■	■	■	■	■ ¹⁾	■ ²⁾	
	CAN/CSA C22.2 No.14	■	■	■	■	■	■	■	■	■	■	■	■ ¹⁾	■ ²⁾	
	CAN/CSA C22.2 No.213 (hazardous locations)	■	■	■	■	■	■	■	■	■	■	■	■ ¹⁾	■ ²⁾	
	GL	■	■	■	■				■	■ ³⁾	■ ⁴⁾	■			
	GOST	■	■	■	■	■	■	■	■	■	■	■	■	■	
	Lloyds Register	■	■	■	■				■	■ ³⁾	■ ⁴⁾	■			
Marks															
	CE	■	■	■	■	■	■	■	■	■	■	■	■	■	
	C-Tick	□	□	□	□	□	□	□	□	□	□	□	□	□	

¹⁾ not for: CL-LAS-PS002, CL-LAS.TD001, CL-LAS.FD001, CL-LAS.TK002, CL-LAS.TK011

²⁾ not for: CL-LAD.TK006, CL-LAD.TK011, CL-LAD.FD002

³⁾ not for: CL-LDC.SDC2, CL-LDC.SAC2, CL-LDC.LAC2, CL-LDC.LNAC2

⁴⁾ not for: CL-LDR.16AC2

Logic relays

Ordering details

Stand alone logic relays



CL-LSR



CL-LST

Logic relays stand alone

Rated operational voltage	Display + Keypad	Timer	Input / Output	Reference code	Catalog number	Weight (1 pce) kg (lb)
24 V AC	■	■	8 inputs / 4 relay outputs	CL-LSR.C12AC1	1SVR440712R0300	0.20 (0.44)
		■		CL-LSR.CX12AC1	1SVR440712R0200	
100-240 V AC	■			CL-LSR.12AC2	1SVR440713R0100	
	■	■		CL-LSR.C12AC2	1SVR440713R0300	
		■		CL-LSR.CX12AC2	1SVR440713R0200	
				CL-LSR.C12DC1	1SVR440710R0300	
12 V DC	■	■		CL-LSR.CX12DC1	1SVR440710R0200	
24 V DC	■			CL-LSR.12DC2	1SVR440711R0100	
	■	■		CL-LSR.C12DC2	1SVR440711R0300	
24 V DC				CL-LSR.CX12DC2	1SVR440711R0200	
	■	■		CL-LST.C12DC2	1SVR440711R1300	
		■		CL-LST.CX12DC2	1SVR440711R1200	

6

Display modules



CL-LDD.K

Rated operational voltage	Description	Reference code	Catalog number	Weight (1 pce) kg (lb)
-	Graphic display 132 x 64 pixel	CL-LDD.XK	1SVR440839R4500	0.14 (0.30)
-	Graphic display 132 x 64 pixel, with keypad	CL-LDD.K	1SVR440839R4400	0.13 (0.29)
24 V DC	Module to displace the display from the logic relay, incl.	CL-LDC.SDC2	1SVR440841R0000	0.16 (0.36)
100-240 V DC	connecting cable CL-LAD.TK007, 5m, length adaptable	CL-LDC.SAC2	1SVR440843R0000	0.16 (0.36)



CL-LDC.S..

Logic relays

Ordering details

Expandable logic relays



CL-LMR



CL-LER



CL-LEC

Logic relays expandable

Rated operational voltage	Display + Keypad	Timer	Input / Output	Reference code	Catalog number	Weight (1 pce) kg (lb)
24 V AC	■	■	12 inputs / 6 relay outputs	CL-LMR.C18AC1	1SVR440722R0300	0.36 (0.79)
100-240 V AC	■	■		CL-LMR.CX18AC1	1SVR440722R0200	
				CL-LMR.C18AC2	1SVR440723R0300	
12 V DC	■	■		CL-LMR.CX18AC2	1SVR440723R0200	
				CL-LMR.C18DC1	1SVR440720R0300	
24 V DC	■	■		CL-LMR.CX18DC1	1SVR440720R0200	
			CL-LMR.C18DC2	1SVR440721R0300		
24 V DC	■	■	CL-LMR.CX18DC2	1SVR440721R0200		
			CL-LMT.C20DC2	1SVR440721R1300	0.36 (0.79)	
24 V DC	■	■	CL-LMT.CX20DC2	1SVR440721R1200		

Expansions

Rated operational voltage	Description	Reference code	Catalog number	Weight (1 pce) kg (lb)
-	2 relay outputs	CL-LER.2O	1SVR440709R5000	0.07 (0.15)
100-240 V AC	12 inputs, 6 relay outputs	CL-LER.18AC2	1SVR440723R0000	0.26 (0.57)
24 V DC		CL-LER.18DC2	1SVR440721R0000	0.22 (0.49)
24 V DC	12 inputs, 8 transistor outputs	CL-LET.20DC2	1SVR440721R1000	0.21 (0.46)
-	Coupler unit for remote expansion with a distance of up to 30 m	CL-LEC.CI000	1SVR440709R0000	0.07 (0.15)

Logic relays

Ordering details

CL-LA...



CL-LAS.PS002



CL-LAS.TK001



CL-LAS.MD003

Description	Reference code	Catalog number	Weight (1 pce) kg (lb)
Software for programming and control of CL range devices. Installation CD-ROM for Microsoft Windows™.	CL-LAS.PS002	1SVR440799R8000	0.10 (0.21)
Memory module for logic relays Memory size: 32 kB	CL-LAS.MD003	1SVR440799R7000	0.02 (0.04)
Cable with serial interface to connect PC and logic relay. Length: 2 m	CL-LAS.TK001	1SVR440799R6000	0.10 (0.22)
Cable with USB interface to connect PC and logic relay	CL-LAS.TK002	1SVR440799R6100	0.06 (0.13)
Cable for point-to-point connection of remote-display connection module and logic relay, length adaptable	CL-LAD.TK007	1SVR440899R6600	0.20 (0.44)
Fixing brackets for screw mounting of logic relay, expansion, display base module	CL-LAS.FD001	1SVR440799R5000	0.01 (0.01)
Spare plug (CL-LINK) for connection of logic relay to expansion	CL-LAS.TK011	1SVR440799R5100	0.10 (0.22)
Primary switch mode power supplies, Rated input voltage: 100-240 V AC Rated output voltage/current: 24 V DC / 0.42 A	CP-D 24/0.42 ¹⁾	1SVR427041R0000	0.06 (0.13)
Primary switch mode power supplies, Rated input voltage: 100-240 V AC Rated output voltage/current: 24 V DC / 1.3 A	CP-D 24/1.3 ²⁾	1SVR427043R0100	0.19 (0.41)

¹⁾ replaces CL-LAS.SD001, technical data see chapter "Primary switch mode power supplies"

²⁾ replaces CL-LAS.SD002, technical data see chapter "Primary switch mode power supplies"

Logic relays

Ordering details

Display systems

Display systems

Rated operational voltage	Description	Reference code	Catalog number	Weight (1 pce) kg (lb)
-	Display module Graphic display 132 x 64 pixel	CL-LDD.XK	1SVR440839R4500	0.14 (0.30)
-	Display module Graphic display 132 x 64 pixel, with keypad	CL-LDD.K	1SVR440839R4400	0.13 (0.29)
24 V DC	Display base module	CL-LDC.LDC2	1SVR440821R0000	0.16 (0.36)
100-240 V AC	CPU / power supply	CL-LDC.LAC2	1SVR440823R0000	
24 V DC	Display base module	CL-LDC.LNDC2	1SVR440821R1000	0.17 (0.38)
100-240 V AC	CPU / power supply, networking-compatible (CL-NET)	CL-LDC.LNAC2	1SVR440823R1000	
100-240 V AC	Display I/O module	CL-LDR.16AC2	1SVR440853R0000	0.17 (0.38)
24 V DC	12 inputs, 4 relay outputs	CL-LDR.16DC2	1SVR440851R0000	
24 V DC	Display I/O module 12 inputs, 4 relay outputs, 1 analog output	CL-LDR.17DC2	1SVR440851R2000	0.17 (0.38)
24 V DC	Display I/O module 12 inputs, 4 transistor outputs	CL-LDT.16DC2	1SVR440851R1000	0.14 (0.30)
24 V DC	Display I/O module 12 inputs, 4 transistor outputs, 1 analog output	CL-LDT.17DC2	1SVR440851R3000	0.14 (0.30)



CL-LDD.K



CL-LDC.LN..

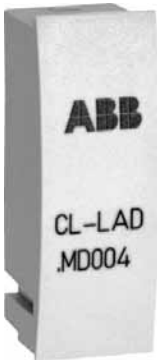

CL-LAD.MD004



CL-LAD.TK001



CL-LAD.TK002

CL-LAD...

Description	Reference code	Catalog number	Weight (1 pce) kg (lb)
Memory module for display base modules Memory size: 256 kB	CL-LAD.MD004	1SVR440899R7000	0.02 (0.03)
Cable with serial interface to connect PC and display base module	CL-LAD.TK001	1SVR440899R6000	0.11 (0.23)
Cable with USB interface to connect PC and display base module	CL-LAD.TK011	1SVR440899R6700	
Network cable (CL-NET) to connect 2 display base modules Length: 0.3 m	CL-LAD.TK002	1SVR440899R6100	0.05 (0.12)
Network cable (CL-NET) to connect 2 display base modules Length: 0.8 m	CL-LAD.TK003	1SVR440899R6200	0.07 (0.14)
Network cable (CL-NET) to connect 2 display base modules Length: 1.5 m	CL-LAD.TK004	1SVR440899R6300	0.08 (0.18)
Cable for point-to-point connection of remote display connection modules and display base module, length adaptable, Length: 5 m	CL-LAD.TK005	1SVR440899R6400	0.20 (0.44)
Cable for point-to-point connection of 2 display base modules, length adaptable. Length: 5 m	CL-LAD.TK006	1SVR440899R6500	0.12 (0.26)
Termination resistor, content: 2 pieces	CL-LAD.TK009	1SVR440899R6900	0.01 (0.02)
Protective cover, transparent, for harsh environmental conditions and application in the food industry	CL-LAD.FD001	1SVR440899R1000	0.03 (0.07)
Protective cover, transparent and sealable	CL-LAD.FD011	1SVR440899R2000	0.03 (0.07)
Assembly tool for mounting of display modules	CL-LAD.FD002	1SVR440899R3000	

Logic relays

Technical data

Data at $T_a = 25\text{ °C}$ and rated values, if nothing else indicated.

Type	CL-LSR.C...12DC1	CL-LSR....12DC2 CL-LST.C...12DC2	CL-LSR.C...12AC1	CL-LSR...12AC2
Input circuit - supply circuit				
Rated operational voltage U_n	12 V DC	24 V DC	24 V AC	100-240 V AC
Rated operational voltage tolerance	-15...+30 %	-15...+20 %	-15...+10 %	-
Operational voltage range	10.2-15.6 V DC	20.4-28.8 V DC	20.4-26.4 V AC	85-264 V AC
Rated frequency	-	0 Hz	-	50/60 Hz
Rated frequency tolerance	-	-	-	±5 %
Residual ripple	-	≤ 5 %	-	-
Input current				
at 12 V DC	typ. 140 mA	-	-	-
at 24 V DC	-	typ. 80 mA	-	-
at 24 V AC	-	-	typ. 200 mA	-
at 115/120 V AC (60 Hz)	-	-	-	typ. 40 mA
at 230/240 V AC (50 Hz)	-	-	-	typ. 20 mA
Power failure buffering (IEC/EN 61131-2)	-	10 ms	-	20 ms
Power dissipation				
at 12 V DC	typ. 2 W	-	-	-
at 24 V DC	-	typ. 2 W	-	-
at 24 V AC	-	-	typ. 5 VA	-
at 115/120 V AC	-	-	-	typ. 5 VA
at 230/240 V AC	-	-	-	typ. 5 VA

6

Type	CL-LMR.C...18DC1	CL-LMR.C...18DC2 CL-LMT.C...20DC2	CL-LMR.C...18AC1	CL-LMR.C...18AC2
Input circuit - supply circuit				
Rated operational voltage U_n	12 V DC	24 V DC	24 V AC	100-240 V AC
Rated operational voltage tolerance	-15...+30 %	-15...+20 %	-15...+10 %	-
Operational voltage range	10.2-15.6 V DC	20.4-28.8 V DC	20.4-26.4 V AC	85-264 V AC
Rated frequency	-	0 Hz	-	50/60 Hz
Rated frequency tolerance	-	-	-	±5 %
Residual ripple	-	≤ 5 %	-	-
Input current				
at 12 V DC	typ. 200 mA	-	-	-
at 24 V DC	-	typ. 140 mA	-	-
at 24 V AC	-	-	typ. 300 mA	-
at 115/120 V AC (60 Hz)	-	-	-	typ. 70 mA
at 230/240 V AC (50 Hz)	-	-	-	typ. 35 mA
Power failure buffering (IEC/EN 61131-2)	-	10 ms	-	20 ms
Power dissipation				
at 12 V DC	typ. 3.5 W	-	-	-
at 24 V DC	-	typ. 3.5 W	-	-
at 24 V AC	-	-	typ. 7 VA	-
at 115/120 V AC	-	-	-	typ. 10 VA
at 230/240 V AC	-	-	-	typ. 10 VA

Type	CL-LER.18DC2 CL-LET.20DC2	CL-LER.18AC2		
Input circuit - supply circuit				
Rated operational voltage U_n	24 V DC	100-240 V AC	-	-
Rated operational voltage tolerance	-15...+20 %	-15...+10 %	-	-
Operational voltage range	20.4-28.8 V DC	85-264 V AC	-	-
Rated frequency	0 Hz	50/60 Hz	-	-
Rated frequency tolerance	-	±5 %	-	-
Residual ripple	≤ 5 %	-	-	-
Input current				
at 24 V DC	typ. 140 mA	-	-	-
at 115/120 V AC (60 Hz)	-	typ. 70 mA	-	-
at 230/240 V AC (50 Hz)	-	typ. 35 mA	-	-
Power failure buffering (IEC/EN 61131-2)	10 ms	20 ms	-	-
Power dissipation				
at 24 V DC	typ. 3.4 W	-	-	-
at 115/120 V AC	-	typ. 10 VA	-	-
at 230/240 V AC	-	typ. 10 VA	-	-

Data at $T_a = 25\text{ °C}$ and rated values, if nothing else indicated.

Type		CL-LSR.C...12DC1	CL-LSR...12DC2 CL-LST.C...12DC2	CL-LSR.C...12AC1	CL-LSR.C...12AC2
Input circuit - Digital inputs					
Number				8	
Inputs can be used as analog inputs				2 (I7, I8)	-
Indication of operational states				LCD-Display (if existing)	
Electrical isolation	from voltage supply			no	
	between digital inputs			no	
	from the outputs			yes	
Rated operational voltage U_o		12 V DC	24 V DC	24 V AC	
	U_o on „0“ signal	4 V DC (I1-I8)	< 5 V DC (I1-I8)	0-6 V AC (sinusoidal)	0-40 V AC (sinusoidal)
	U_o on „1“ signal	8 V DC (I1-I8)	> 15 V DC (I1-I6), > 8 V DC (I7, I8)	> 9.5 V DC, 14-26,4 V AC (sinusoidal) (I1-I6), > 7 V AC (sinusoidal) (I7,I8)	79-264 V AC (sinusoidal)
Rated frequency				50-60 Hz	
Input current on „1“ signal		3.3 mA (at 12 V DC, I1-I6), 1.1 mA (at 12 V DC, I7, I8)	3.3 mA (at 24 V DC, I6-I7), 2.2 mA (at 24 V DC, I7, I8)	4 mA (at 24 V AC, 50 Hz, I1-I6), 2 mA (at 24 V AC, 50 Hz, I7,I8), 2 mA (at 24 V DC, I7, I8)	6x0.25 mA (at 115 V AC, 60 Hz, I1-I6), 6x0.5 mA (at 230 V AC, 50 Hz, I1-I6) 2x4 mA (at 115 V AC, 60 Hz, I7, I8), 2x6 mA (at 230 V AC, 50 Hz, I7, I8)
Time delay from „0“ to „1“	debounce ON		20 ms	80 ms (at 50 Hz), 66 ² / ₃ ms (at 60 Hz)	
	debounce OFF	typ. 0.3 ms (I1-I6), typ. 0.35 ms (I7, I8)	typ. 0.25 ms (I1-I8)	20 ms (at 50 Hz), 16 ² / ₃ ms (at 60 Hz)	
Time delay from „1“ to „0“	debounce ON		20 ms	80 ms (at 50 Hz, 66 ² / ₃ ms (at 60 Hz)	80 ms (at 50 Hz, I1-I6), 66 ² / ₃ ms (at 60 Hz, I1-I6) 160 ms (at 50 Hz, I7, I8), 150 ms (at 60 Hz, I7, I8)
	debounce OFF	typ. 0.3 ms (I1-I6), typ. 0.15 ms (I7, I8)	-	20 ms (at 50 Hz), 16 ² / ₃ ms (at 60 Hz)	20 ms (at 50 Hz, I1-I6), 16 ² / ₃ ms (at 60 Hz, I1-I6) 100 ms (at 50 Hz, I7, I8), 100 ms (at 60 Hz, I7, I8)
Cable length (unshielded)		100 m		-	-
Maximum cable length per input		-		40 m	40 m (I1-I6), 100 m (I7, I8)
Frequency counter	Number	2 (I3, I4)		-	-
	counting frequency	< 1 kHz		-	-
	pulse shape	square-wave		-	-
	pulse / pause ratio	1:1		-	-
Rapid counter inputs	Number	2 (I1, I2)		-	-
	counting frequency	< 1 kHz		-	-
	pulse shape	square-wave		-	-
	pulse / pause ratio	1:1		-	-
Cable length (shielded)		< 20 m		-	-
Input circuit - Analog inputs					
Number			2 (I7, I8)		-
Electrical isolation	from voltage supply		no		-
	from the digital inputs		no		-
	from the outputs		yes		-
	from PC interface, memory module, CL-NET, CL-LINK		no		-
Input type			DC voltage		-
Signal range			0-10 V DC		-
Resolution	analog		0.01 V		-
	digital		0.01 V; 10 Bit (value 1-1023)		-
Input impedance			11.2 kΩ		-
Accuracy of the actual value	two CL devices		±3 %		-
	within one device		±2 %, ±0.12 V		-
Conversion time analog/digital	Input delay ON		20 ms		-
	Input delay OFF		each cycle		-
Input current			< 1 mA		-
Cable length (shielded)			< 30 m		-

Logic relays

Technical data

Data at $T_a = 25\text{ °C}$ and rated values, if nothing else indicated.

Type		CL-LMR.C...18DC1	CL-LMR.C...18DC2 CL-LMT.C...20DC2	CL-LMR.C...18AC1	CL-LMR.C...18AC2
Input circuit - Digital inputs					
Number		12 V DC	24 V DC	24 V AC	115 / 230 V AC
Inputs can be used as analog inputs			4 (I7, I8, I11, I12)		-
Indication of operational states			LCD-Display (if existing)		
Electrical isolation	from voltage supply			no	
	between digital inputs			no	
	from the outputs			yes	
	from PC interface, memory module, CL-NET, CL-LINK		no		yes
Rated operational voltage U_o		12 V DC	24 V DC	24 V AC	
	U_o on „0“ signal	4 V DC (I1-I12)	< 5 V DC (I1-I12, R1-R12)	0-6 V AC (sinusoidal)	0-40 V AC (sinusoidal)
	U_o on „1“ signal	8 V DC (I1-I12)	> 15 V DC (I1-I6, I9, I10) > 8 V DC (I7, I8, I11, I12)	> 9.5 V DC, 14-26.4 V AC (sinusoidal) (I1-I6, I9, I10) > 7 V AC (sinusoidal) (I7, I8; I11, I12)	79-264 V AC (sinusoidal)
Rated frequency				50-60 Hz	
Input current on „1“ signal		3.3 mA (at 12 V DC, I1-I6, I9-I12), 1.1 mA (at 12 V DC, I7, I8)	3.3 mA (at 24 V DC, I1-I6, I9, I10), 2.2 mA (at 24 V DC, I7, I8, I11, I12)	4 mA (at 24 V AC, 50 Hz, I1-I6, I9, I10), 2 mA (at 24 V AC, 50 Hz, I7, I8, I11, I12), 2 mA (at 24 V DC, I7, I8, I11, I12)	6x0.25 mA (at 115 V AC, 60 Hz, I1-I6), 6x0.5 mA (at 230 V AC, 50 Hz, I1-I6) 2x4 mA (at 115 V AC, 60 Hz, I7, I8), 2x6 mA (at 230 V AC, 50 Hz, I7, I8), 4x0.25 mA (at 115 V AC, 60 Hz, I9-I12), 4x0.5 mA (at 230 V AC, 50 Hz, I9-I12)
Time delay from „0“ to „1“	debounce ON	20 ms		80 ms (at 50 Hz), 66 ^{2/3} ms (at 60 Hz)	
	debounce OFF	typ. 0.3 ms (I1-I6, I9, I10), typ. 0.35 ms (I7, I8, I11, I12)	typ. 0.25 ms	20 ms (at 50 Hz), 16 ^{2/3} ms (at 60 Hz)	
Time delay from „1“ to „0“	debounce ON	20 ms		80 ms (at 50 Hz), 66 ^{2/3} ms (at 60 Hz)	
	debounce OFF	typ. 0.4 ms (I1-I6, I9, I10), typ. 0.35 ms (I7, I8, I11, I12)	-	20 ms (at 50 Hz), 16 ^{2/3} ms (at 60 Hz)	
Cable length (unshielded)		100 m			
Maximum cable length per input				max. 40 m, typ. 40 m (I9, I10)	typ. 40 m (I1-I6, I9-I12), typ. 100 m (I7, I8)
Frequency counter	number	2 (I3, I4)		-	-
	counting frequency	< 1 kHz		-	-
	pulse shape	square-wave		-	-
	pulse / pause ratio	1:1		-	-
Rapid counter inputs	number	2 (I1, I2)		-	-
	counting frequency	< 1 kHz		-	-
	pulse shape	square-wave		-	-
	pulse / pause ratio	1:1		-	-
Cable length (shielded)		< 20 m			
Input circuit - Analog inputs					
Number			4 (I7, I8, I11, I12)		-
Electrical isolation	from voltage supply		no		-
	from the digital inputs		no		-
	from the outputs		yes		-
	from PC interface, memory module, CL-NET, CL-LINK		no		-
Input type			DC voltage		-
Signal range			0-10 V DC		-
Resolution	analog		0.01 V		-
	digital		0.01 V; 10 Bit (value 1-1023)		-
Input impedance			11.2 k Ω		-
Accuracy of the actual value	two CL devices		$\pm 3\%$		-
	within one device		$\pm 2\%$, $\pm 0.12\text{ V}$		-
Conversion time analog/digital	Input delay ON		20 ms		-
	Input delay OFF		each cycle		-
Input current			< 1 mA		-
Cable length (shielded)			< 30 m		-

Data at $T_a = 25\text{ °C}$ and rated values, if nothing else indicated.

Type		CL-LER.18DC2 CL-LET.20DC2	CL-LER.18AC2
Input circuit - Digital inputs		24 V DC	115 / 230 V AC
Number			12
Inputs can be used as analog inputs			-
Indication of operational states			-
Electrical isolation	from voltage supply		no
	between digital inputs		no
	from the outputs		yes
	from PC interface, memory module, CL-NET, CL-LINK		no
Rated operational voltage U_o		24 V DC	
	U_o on „0“ signal	< 5 V DC (I1-I12, R1-R12)	0-40 V AC (sinusoidal)
	U_o on „1“ signal	-	79-264 V AC (sinusoidal)
Rated frequency		-	50-60 Hz
Input current on „1“ signal		3.3 mA (at 24 V DC, R1-R12)	12x0.25 mA (at 115 V AC, 60 Hz, R1-R12), 12x0.5 mA (at 230 V AC, 50 Hz, R1-R12)
Time delay from „0“ to „1“	debounce ON	20 ms	80 ms (at 50 Hz, I1-I12, R1-R12), 66 ² / ₃ ms (at 60 Hz, I1-I12, R1-R12)
	debounce OFF	typ. 0.25 ms (R1-R12)	20 ms (at 50 Hz, I1-I12, R1-R12), 16 ² / ₃ ms (at 60 Hz, I1-I12, R1-R12)
Time delay from „1“ to „0“	debounce ON	20 ms	80 ms (at 50 Hz, I1-I12, R1-R12), 66 ² / ₃ ms (at 60 Hz, I1-I12, R1-R12)
	debounce OFF	-	20 ms (at 50 Hz, I1-I12, R1-R12), 16 ² / ₃ ms (at 60 Hz, I1-I12, R1-R12)
Cable length (unshielded)		100 m	-
Maximum cable length per input		-	typ. 40 m (I1-I6, I9-I12, R1-R12), typ. 100 m (I7, I8)

6

Logic relays

Technical data

CL Range
Logic relays

Data at $T_a = 25\text{ °C}$ and rated values, if nothing else indicated.

Type	CL-LSR...	CL-LMR... CL-LER...	CL-LER.20
Output circuit - Relay outputs			
Number	4	6	2
Outputs in groups of	1		2
Parallel switching of outputs to increase capacity	not permissible		
Fusing of the output relay	circuit-breaker B16 or fuse 8 A (slow-acting)		
Electrical isolation	from voltage supply	yes	
	from the inputs	yes	
	from PC interface, memory module, CL-NET, CL-LINK	no	
	protective separation	300 V AC	
	basic isolation	600 V AC	
Mechanical lifetime	10x10 ⁶ switching cycles		
Rung	conventional thermal current (10 A UL)	8 A	
	recommended for load 12 V AC/DC	> 500 mA	
	short-circuit proof $\cos \varphi = 1$; characteristic B16 at 600 A	16 A	
	short-circuit proof $\cos \varphi = 0.5$ up to 0.7; characteristic B16 at 900 A	16 A	
	Rated impulse withstand voltage U_{imp} contact-coil	6 kV	
	Rated operational voltage U_a	250 V AC	
Rated insulation voltage U_i	250 V AC		
Protective separation (EN 50178)	between coil and contact	300 V AC	
	between two contacts	300V AC	
Making capacity	AC15, 250 V AC, 3 A (600 ops./h)	300.000 switching cycles	
	DC13, L/R ≤ 150 ms, 24 V DC, 1 A (500 ops./h)	200.000 switching cycles	
Breaking capacity	AC15, 250 V AC, 3 A (600 ops./h)	300.000 switching cycles	
	DC13, L/R ≤ 150 ms, 24 V DC, 1 A (500 ops./h)	200.000 switching cycles	
Incandescent lamp load	1000 W at 230/240 V AC	25.000 switching cycles	
	500 W at 115/120 V AC	25.000 switching cycles	
Fluorescent lamp load	10 x 58 W at 230/240 V AC with electrical control gear	25.000 switching cycles	
	10 x 58 W at 230/240 V AC uncompensated	25.000 switching cycles	
	1 x 58 W at 230/240 V AC conventional compensated	25.000 switching cycles	
Switching frequency	mechanical operations	10x10 ⁶	
	switching frequency	10 Hz	
	resistive load / lamp load	2 Hz	
	inductive load	0.5 Hz	
UL/CSA			
Continuous current at 240 V		10 A AC	
Continuous current at 24 V		8 A DC	
AC	Utilization category (Control Circuit Rating Codes)	B 300 Light Pilot Duty	
	max. rated operational voltage	300 V AC	
	max. continuous thermal current $\cos \varphi = 1$ at B 300	5 A	
	max. making / breaking apparent power (Make/Break) $\cos \varphi \neq 1$ at B 300	3600/360 VA	
DC	Utilization category (Control Circuit Rating Codes)	R 300 Light Pilot Duty	
	max. rated operational voltage	300 V DC	
	max. continuous thermal current at R 300	1 A	
	max. making / breaking apparent power (Make/Break) at R 300	28/28 VA	

6

Data at $T_a = 25\text{ °C}$ and rated values, if nothing else indicated.

Type	CL-LST...	CL-LMT...	CL-LET...
Output circuit - Transistor outputs			
Number	4	8	
Rated operational voltage U_o	24 V DC		
Operational voltage range	20.4-28.8 V DC		
Residual ripple	≤ 5 %		
Supply current	on „0“ signal	typ. 9 mA / max. 16 mA	typ. 18 mA / max. 32 mA
	on „1“ signal	typ. 12 mA / max. 22 mA	typ. 24 mA / max. 44 mA
Reverse voltage protection	yes (Attention: If supply voltage is reversed, applying voltage at the outputs, causes a short circuit.)		
Electrical isolation	from voltage supply	yes	
	from the inputs	yes	
	from PC interface, memory module, CL-NET, CL-LINK	-	
Rated operational current I_o on „1“ signal DC	max. 0.5 A		
Lamp load without R_f	5 W		
Residual current on „0“ signal per channel	< 0.1 mA		
Max. output voltage	on „0“ signal at external load < 10 MΩ	2.5 V	
	on „1“ signal at $I_o = 0.5\text{ A}$	$U = U_o - 1\text{ V}$	
Short-circuit protection	yes, thermal (analysis results from diagnosis input I16, I15; R15, R16)		
Short-circuit tripping current for $R_f \leq 10\text{ m}\Omega$	$0.7\text{ A} \leq I_o \leq 2\text{ A}$ per output		
Total short-circuit current	8 A	16 A	
Peak short-circuit current	16 A	32 A	
Thermal tripping	yes		
Max. switching frequency with constant resistive load $R_L < 100\text{ k}\Omega$ (depending on active channels and their load)	40.000 switching cycles/h		
Parallel connection of outputs	with resistive load, inductive load with external suppressor, combination within one group	group 1: Q1-Q4	group 1: Q1-Q4, group 2: Q5-Q8
	number of outputs	max. 4	
	max. total current	2 A (Attention! Outputs must be actuated simultaneously and for the same length of time.)	
Indication of operational states of the outputs	LCD-Display (if existing)		
Inductive load ¹⁾ without external suppressor			
$T_{0.95} = 1\text{ ms}$, $R = 48\ \Omega$, $L = 16\text{ mH}$	utilization factor	0.25 g	
	duty time	100 %	
	max. switching frequency $f = 0.5\text{ Hz}$ (max. duty time = 50 %)	1500 switching cycles	
DC13, $T_{0.95} = 72\text{ ms}$, $R = 48\ \Omega$, $L = 1.15\text{ H}$	utilization factor	0.25 g	
	duty time	100 %	
	max. switching frequency $f = 0.5\text{ Hz}$ (max. duty time = 50 %)	1500 switching cycles	
$T_{0.95} = 15\text{ ms}$, $R = 48\ \Omega$, $L = 0.24\text{ H}$	utilization factor	0.25 g	
	duty time	100 %	
	max. switching frequency $f = 0.5\text{ Hz}$ (max. duty time = 50 %)	1500 switching cycles	
Inductive load ¹⁾ with external suppressor			
	demand factor	1 g	
	duty time	100 %	
	max. switching frequency	depends on suppressor	
	max. duty time		

¹⁾ For inductive loading, without external suppression of the transistor outputs, the following applies:
 $T_{0.95}$ = time in ms, until 95 % of the steady-state current is achieved. $T_{0.95} \cdot 3 \times T_{0.65} = 3 \times L/R$.

Data transfer rate in the CL-NET network: bus lengths of 40 m and over only attainable with cables with additional cross-section and connection adapter.

Logic relays

Technical data

Data at $T_a = 25\text{ °C}$ and rated values, if nothing else indicated.

Type	CL-LSR..., CL-LST...	CL-LMR... CL-LMT.. CL-LET., CL-LER.18..	CL-LER.20 CL-LEC.CI000
General data			
Dimensions (W x H x D)	71.5 mm x 90 mm x 58 mm (2.81 inch x 3.54 inch x 2.28 inch)	107.5 mm x 90 mm x 58 mm (4.23 inch x 3.54 inch x 2.28 inch)	35.5 mm x 90 mm x 58 mm (1.40 inch x 3.54 inch x 2.28 inch)
Weight	0.2 kg (0.44 lb)	0.3 kg (0.66 lb)	0.07 kg (0.15 lb)
Mounting	DIN rail (IEC/EN 60715), 35 mm or screw mounting with fixing brackets CL-LAS.FD001 (accessories)		
Mounting position	horizontal / vertical		
Electrical connection			
Wire size	rigid fine-strand with wire end ferrule	0.2-4 mm ² (22-12 AWG) 0.2-2.5 mm ² (22-12 AWG)	
Max. tightening torque	0.6 Nm		
Environmental data			
Ambient temperature range	operation storage	-25...+55 °C, cold acc. to IEC 60068-2-1, heat acc. to IEC 60068-2-2 -40...+70 °C	
LCD-Display (clearly legible)	0...+55 °C		
Condensation	avoid condensation with suitable methods		
Humidity, no condensation (IEC/EN 60068-2-30)	5-95 %		
Air pressure (operation)	795-1080 hPa		
Degree of protection (IEC/EN 60529)	IP20		
Vibration (IEC/EN 60068-2-6)	10-57 Hz (constant amplitude 0.15 mm), 57-150 Hz (constant acceleration 2 g)		
Shock resistance (half-sine 15 g / 11 ms) (IEC/EN 60068-2-27)	18 Shocks		
Drop (IEC/EN 60068-2-31) height of fall	50 mm		
Free fall, packaged (IEC/EN 60068-2-32)	1 m		
Insulation data			
Overvoltage category	II		
Pollution degree (DIN EN 60947)	2		
Rating of air and creepage distances	EN 50178, UL 508, CSA C22.2, No. 142		
Insulation resistance	EN 50178		
Standards			
Standards and directives	EN 55011, EN 55022, IEC/EN 61000-4, IEC 60068-2-6, IEC 60068-2-27		
Electromagnetic compatibility			
Interference immunity			
electrostatic discharge (ESD)	IEC/EN 61000-4-2	Level 3 (air discharge 8 kV, contact discharge 6 kV)	
electromag. field (HF radiation resistance)	IEC/EN 61000-4-3	10 V/m	
fast transients (Burst)	IEC/EN 61000-4-4	Level 3 (supply cable 2 kV, signal lines 2 kV)	
powerful impulses (Surge)	IEC/EN 61000-4-5	supply cable symmetrical (AC) 2 kV, Level 2 (supply cable symmetrical (DC) 0.5 kV)	
HF line emission	IEC/EN 61000-4-6	10 V	
Interference suppression (EN 55011, EN 55022)	class B		
Real time clock			
Back-up time	see diagram		-
Accuracy	typ. ±5 (±0.5 h/year)		-
Repeat accuracy of the time relay			
Accuracy (from value)	±1		-
Resolution	range „S“	10 ms	-
	range „M:“	1 s	-
	range „H:M“	1 min	-
Retention behaviour			
Write cycles of retention memory (minimum)	1.000.000 (10 ⁶)		-

Technical diagram

Back-up time of the real time clock

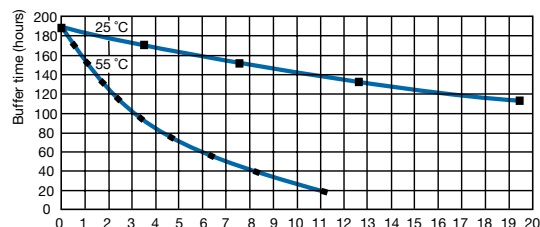

Data at $T_a = 25\text{ °C}$ and rated values, if nothing else indicated.

Type		CL-LDD...
Input circuit - Supply circuit		
Power failure buffering (IEC/EN 61131-2)		10 ms
General data		
Dimensions (W x H x D)		with keypad: 86.5 x 86.5 x 21.5 mm (3.41 x 3.41 x 0.85 inch) without keypad: 86.5 x 86.5 x 20 mm (3.41 x 3.41 x 0.79 inch)
6 Weight		0.13 kg (0.29 lb)
Mounting		2 x 22.5 mm, with 2 retainers screwed
Mounting position		horizontal / vertical
Environmental data		
Ambient temperature range	operation	-25...+55 °C (cold acc. to IEC 60068-2-1, heat acc. to IEC 60068-2-2)
	storage	-40...+70 °C
LCD-Display (clearly legible)		-5...+50 °C, -10...0 °C (with backlit / continuous operation)
Condensation		avoid condensation with suitable methods
Humidity, no condensation (IEC/EN 60068-2-30)		5-95 %
Air pressure (operation)		795-1080 hPa
Degree of protection (IEC/EN 60529)		IP65
Vibration (IEC/EN 60068-2-6)		10-57 Hz (constant amplitude 0.15 mm), 57-150 Hz (constant acceleration 2 g)
Shock resistance (half-sine 15 g / 11 ms) (IEC/EN 60068-2-27)		18 Shocks
Drop (IEC/EN 60068-2-31) height of fall		50 mm
Free fall, packaged (IEC/EN 60068-2-32)		1 m
Insulation data		
Pollution degree (DIN EN 60947)		3
Rating of air and creepage distances		EN 50178, UL 508, CSA 22.2, No 142
Insulation resistance		EN 50178
Standards		
Standards and directives		EN 61000-6-1, EN 61000-6-2, EN 61000-6-3, EN 61000-6-4, IEC 60068-2-6, IEC 60068-2-27
Electromagnetic compatibility		
Interference immunity		
electrostatic discharge (ESD)	IEC/EN 61000-4-2	Level 3 (air discharge 8 kV, contact discharge 6 kV)
electromag. field (HF radiation resistance)	IEC/EN 61000-4-3	10 V/m
fast transients (Burst)	IEC/EN 61000-4-4	Level 3 (supply cable 2 kV, signal lines 2 kV)
powerful impulses (Surge)	IEC/EN 61000-4-5	Level 3 (supply cable symmetrical 2 kV, CL-LDC.L...AC2) Level 2 (0.5 kV supply cable symmetrical, CL-LDC.L...AC2)
HF line emission	IEC/EN 61000-4-6	10 V
Interference suppression (EN 55011, EN 55022)		class B

Logic relays

Technical data

Data at $T_a = 25\text{ °C}$ and rated values, if nothing else indicated.

Type	CL-LDC. SDC2	CL-LDC. SAC2	CL-LDC. LDC2	CL-LCD. LAC2	CL-LDC. LNDC2	CL-LDC. LNAC2
Input circuit - Supply circuit						
Rated operational voltage U_o	24 V DC	100-240 V AC	24 V DC	100-240 V AC	24 V DC	100-240 V AC
Rated operational voltage tolerance	-15...+20 %	-15...+10 %	-15...+20 %	-15...+10 %	-15...+20 %	-15...+10 %
Operational voltage range	20.4-28.8 V DC	85-264 V AC	20.4-28.8 V DC	85-264 V AC	20.4-28.8 V DC	85-264 V AC
Frequency	0 Hz	50/60 Hz	0 Hz	50/60 Hz	0 Hz	50/60 Hz
Frequency tolerance	-	± 5 %	-	± 5 %	-	± 5 %
Residual ripple	≤ 5 %	-	≤ 5 %	-	≤ 5 %	-
Input current	at 24 V DC typ. 185 mA	-	typ. 200 mA	-	typ. 200 mA	-
	at 115/120 V AC (60 Hz)	typ. 90 mA	-	typ. 90 mA	-	typ. 90 mA
	at 230/240 V AC (50 Hz)	typ. 60 mA	-	typ. 60 mA	-	typ. 60 mA
Power failure buffering (IEC/EN 61131-2)	10 ms					
Power dissipation	at 24 V DC 1.5 W	-	3.4 W	-	3.4 W	-
	at 115/120 V AC	typ. 11 VA	-	typ. 11 VA	-	typ. 11 VA
	at 230/240 V AC	typ. 15 VA	-	typ. 15 VA	-	typ. 15 VA
Network - point-to-point connection						
Number of stations	1		-			
Data transfer rate	CL-LS..., CL-LM...	9.6 kBaud	-			
	CL-LDD	19.2 kBaud	-			
Distance	max. 5 m					
Electrical isolation	to voltage supply	yes	-			
	to connected device	yes	-			
Termination system	spring-type terminal					
Network - CL-NET						
Number of stations	max. 1		-		max. 8	
Data transfer rate	6 m	-	-		1000 kBit/s	
	25 m	-	-		500 kBit/s	
	40 m	-	-		250 kBit/s	
	125 m	-	-		125 kBit/s	
	300 m	-	-		50 kBit/s	
	700 m	-	-		20 kBit/s	
	1000 m	-	-		10 kBit/s	
Electrical isolation	to voltage supply	-	-		yes	
	to inputs	-	-		yes	
	to outputs	-	-		yes	
	to PC interface, memory module, CL-NET, CL-LINK	-	-		yes	
Bus terminator (first and last station)	-					
Termination system	RJ45, 8 pole					
General data						
Dimensions (W x H x D)	75 x 58 x 36.2 mm (2.95 x 2.28 x 1.43 inch)		107.5 x 90 x 30 mm (4.23 x 3.54 x 1.18 inch)			
Weight	0.164 kg (0.36 lb)		0.145 kg (0.32 lb)			
Mounting	plugged onto CL-LDD		plugged onto CL-LDD or on DIN rail (IEC/EN 60715)			
Mounting position						
Electrical connection - Supply circuit						
Wire size	fine-strand with wire end ferrule	0.2 mm ² / 2.5 mm ² (24-12 AWG)				
	rigid	0.2 mm ² / 4 mm ² (24-12 AWG)				
Electrical connection - Data cable						
Wire size	fine-strand with wire end ferrule	0.08 mm ² / 1.5 mm ² (28-12 AWG)	-		0.2 mm ² / 2.5 mm ² (24-12 AWG)	
	rigid	0.08 mm ² / 2.5 mm ² (28-12 AWG)	-		0.2 mm ² / 4 mm ² (24-12 AWG)	
Environmental data						
Ambient temperature range	operation	-25...+55 °C (cold acc. to IEC 60068-2-1, heat acc. to IEC 60068-2-2)				
	storage	-40...+70 °C				
Condensation	avoid condensation with suitable methods					
Humidity, no condensation (IEC/EN 60068-2-30)	5-95 %					
Air pressure (operation)	795-1080 hPa					
Degree of protection (IEC/EN 60529)	IP20					
Vibration (IEC/EN 60068-2-6)	10-57 Hz (constant amplitude 0.15 mm), 57-150 Hz (constant acceleration 2 g)					

Data at $T_a = 25\text{ °C}$ and rated values, if nothing else indicated.

Type	CL-LDC. SDC2	CL-LDC. SAC2	CL-LDC. LDC2	CL-LCD. LAC2	CL-LDC. LNDC2	CL-LDC. LNAC2
Shock (half-sine 15 g / 11 ms) (IEC/EN 60068-2-27)						18 Shocks
Drop (IEC/EN 60068-2-31) height of fall						50 mm
Free fall, packaged (IEC/EN 60068-2-32)						1 m
Insulation data						
Degree of protection (DIN EN 60947)						2
Rating of air and creepage distances						EN 50178, UL 508, CSA 22.2, No 142
Isolation resistance						EN 50178
Standards						
Standards and directives						EN 61000-6-1, EN 61000-6-2, EN 61000-6-3, EN 61000-6-4, IEC 60068-2-6, IEC 60068-2-27
Electromagnetical compatibility						
Interference immunity						
electrostatic discharge (ESD)	IEC/EN 61000-4-2					Level 3 (air discharge 8 kV, contact discharge 6 kV)
electromag. field (HF radiation resistance)	IEC/EN 61000-4-3					10 V/m
fast transients (Burst)	IEC/EN 61000-4-4					Level 3 (supply cable 2 kV, signal lines 2 kV)
powerful impulses (Surge)	IEC/EN 61000-4-5					Level 3 (supply cable symmetrical 2 kV, CL-LDC.L...AC2)
			Level 2 (1 kV supply cable symmetrical)			Level 2 (0.5 kV supply cable symmetrical, CL-LDC.L...AC2)
HF line emission	IEC/EN 61000-4-6					10 V
Interference suppression (EN 55011, EN 55022)						class B
Real time clock						
Back-up time		-				see diagram
Accuracy		-				typ. ± 5 s/day ($\pm 0,5$ h/year)
Repeat accuracy of the time relay						
Accuracy (from value)		-				$\pm 0,02\%$
Resolution	range „S“	-				5 ms
	range „M:S“	-				1 s
	range „H:M“	-				1 min
Retention behaviour						
Write cycles of retention memory (minimum)		-				10^{10} (read/ write cycles)

Technical diagram

Back-up time of the real time clock

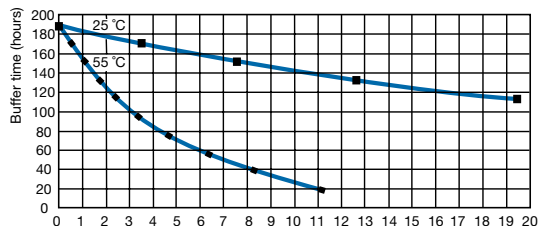

Logic relays

Technical data

Data at $T_a = 25\text{ °C}$ and rated values, if nothing else indicated.

Type		CL-LD...16DC2	CL-LD...17DC2	CL-LDR.16AC2
Input circuit - Digital inputs		24 V DC		115/230 V
Number		12		
Inputs can be used as analog inputs		4 (I7, I8, I11, I12)		-
Indication of operational states		-		LCD-Display (if existing)
Electrical isolation	from supply voltage			no
	from digital inputs			no
	from the outputs			yes
	from PC interface, memory module, CL-NET, CL-LINK			yes
Rated operational voltage U_o		24 V DC		-
	U_o on „0“ signal	< 5 V DC (I1-I6, I9, I10), < 8 V DC (I7, I8, I11, I12)		0-40 V AC (sinusoidal)
	U_o on „1“ signal	> 15 V DC (I1-I6, I9, I10), > 8 V DC (I7, I8, I11, I12)		79-264 V AC (sinusoidal)
Rated frequency		0 Hz		50-60 Hz
Input current on „1“ signal		3.3 mA (at 24 V DC, I1-I6, I9, I10), 2.2 mA (at 24 V DC, I7, I8, I11, I12)		12x0.2 mA (at 115 V AC, 60 Hz, I1-I12), 12x0.5 mA (at 230 V AC, 50 Hz, I1-I12)
Time delay from „0“ to „1“	debounce ON	20 ms		10 ms (at 50 Hz), 100 ms (at 60 Hz)
	debounce OFF	typ. 0.1 ms (I1-I4), typ. 0.25 ms (I5-I12)		10 ms (at 50 Hz), 100 ms (at 60 Hz)
Time delay from „1“ to „0“	debounce ON	20 ms		10 ms (at 50 Hz), 100 ms (at 60 Hz)
	debounce OFF	typ. 0.1 ms (I1-I4), typ. 0.4 ms (I5, I6, I9, I10), typ. 0.2 ms (I7, I8, I11, I12)		10 ms (at 50 Hz), 100 ms (at 60 Hz)
Cable length (unshielded)		100 m		-
Maximum cable length per input		-		typ. 60 m
Frequency counter	number	4 (I1, I2, I3, I4)		-
	counting frequency	< 3 kHz		-
	pulse shape	square-wave		-
	pulse / pause ratio	1:1		-
Incremental counter	number	2 (I1 + I2, I3 + I4)		-
	counting frequency	< 3 kHz		-
	pulse shape	square-wave		-
	signal offset	90°		-
Rapid counter inputs	number	4 (I1, I2, I3, I4)		-
	counting frequency	< 3 kHz		-
	pulse shape	square-wave		-
	pulse / pause ratio	1:1		-
Cable length (shielded)		< 20 m		-
Input circuit - Analog inputs				
Number		4 (I7, I8, I11, I12)		-
Electrical isolation	to voltage supply	no		-
	to digital inputs	no		-
	to outputs	yes		-
	to PC interface, memory modul, CL-NET, CL-LINK	yes		-
Input type		DC voltage		-
Signal range		0-10 V DC		-
Resolution	analog	0.01 V		-
	digital	0.01 V; 10 Bit (value 0-1023)		-
Input impedance		11.2 k Ω		-
Accuracy of the actual value	two CL-LD... devices	$\pm 3\%$		-
	within one device	$\pm 2\%$		-
Conversion time analog/digital		each cycle		-
Input current		< 1 mA		-
Cable length (shielded)		< 30 m		-

Data at $T_a = 25\text{ °C}$ and rated values, if nothing else indicated.

Type	CL-LD...16DC2	CL-LD...17DC2	CL-LDR.16AC2
Output circuit - Analog outputs			
Number	-	1	-
Electrical separation	from voltage supply	no	-
	from the digital inputs	no	-
	from the digital outputs	yes	-
	from PC interface, memory module, CL-NET, CL-LINK	yes	-
Output type	-	DC voltage	-
Signal range	-	0-10 V DC	-
Max. output current	-	0.01 A	-
Burden resistance	-	1 k Ω	-
Overload and short-circuit protection	-	yes	-
Resolution	analog	0.01 V DC	-
	digital	10 Bit, (value: 0-1023)	-
Setting time	-	100 ms	-
Accuracy	-25...+55 °C	2 %	-
	25 °C	1 %	-
Conversion time	-	each CPU cycle	-
General data			
Dimensions (W x H x D)	CL-LDR: 89 x 90 x 44 mm (3.5 x 3.54 x 1.73 inch)		89 x 90 x 44 mm
	CL-LDT (build-in): 89 x 90 x 25 mm (3.5 x 3.54 x 0.98 inch)		(3.5 x 3.54 x 1.73 inch)
Weight	CL-LDR: 0.15 kg (0.33 lb) / CL-LDT: 0.14 kg (0.31 lb)		0.15 kg (0.33 lb)
Mounting	snap-on power supply unit		
Mounting position	horizontal / vertical		
Electrical connection			
Wire size	fine-strand with wire end ferrule	0.2 mm ² / 2.5 mm ² (24-12 AWG)	
	rigid	0.2 mm ² / 4 mm ² (24-12 AWG)	
Electrical connection - Data cable			
Wire size	fine-strand with wire end ferrule	0.08 mm ² / 1.5 mm ² (28-12 AWG)	
	rigid	0.08 mm ² / 2.5 mm ² (28-12 AWG)	
Environmental data			
Ambient temperature range	operation	-25...+55 °C (cold acc. to IEC 60068-2-1, heat acc. to IEC 60068-2-2)	
	storage	-40...+70 °C	
Condensation	avoid condensation with suitable methods		
Humidity, no condensation (IEC/EN 60068-2-30)	5-95 %		
Atmospheric pressure (operation)	795-1080 hPa		
Degree of protection (IEC/EN 60529)	IP20		
Vibration (IEC/EN 60068-2-6)	10-57 Hz (constant amplitude 0.15 mm), 57-150 Hz (constant acceleration 2 g)		
Shock (half-sine 15 g / 11 ms) (IEC/EN 60068-2-27)	18 Shocks		
Drop (IEC/EN 60068-2-31) height of fall	50 mm		
Free fall, packaged (IEC/EN 60068-2-32)	1 m		
Insulation data			
Pollution degree	2		
Rating of air and creepage distances	EN 50178, UL 508, CSA C22.2, No. 142		
Isolation resistance	EN 50178		
Standards			
Standards and directives	EN 61000-6-1/-2/-3/-4, IEC/EN 61000-4, IEC 60068-2-6, IEC 60068-2-27		
Electromagnetic compatibility			
electrostatic discharge (ESD)	IEC/EN 61000-4-2	Level 3 (air discharge 8 kV, contact discharge 6 kV)	
electromag. field (HF radiation res.)	IEC/EN 61000-4-3	10 V/m	
fast transients (Burst)	IEC/EN 61000-4-4	Level 3 (supply cable 2 kV, signal cable 2 kV)	
powerful impulses (Surge)	IEC/EN 61000-4-5	2 kV (supply cable symmetrical), Level 2 (0.5 kV supply cable symmetrical)	
HF line emission	IEC/EN 61000-4-6	10 V	
Interference suppression (EN 55011, EN 55022)	class B		

Logic relays

Technical data

CL Range
Logic relays

Data at $T_a = 25\text{ °C}$ and rated values, if nothing else indicated.

Type		CL-LDR...
Output circuit - Relay outputs		
Number		4
Outputs in groups of		-
Parallel switching of outputs to increase capacity		not permissible
Fusing of the output relay		circuit-breaker B16 or fuse 8 A (slow-acting)
Electrical isolation	from voltage supply	yes
	from the inputs	yes
	from PC interface, memory module, CL-NET, CL-LINK	yes
	protective separation	300 V AC
	Basic isolation	600 V AC
Mechanical lifetime		10×10^6 switching cycles
Rung	conventional thermal current (10 A UL)	8 A
	recommended load 12 V AC/DC	> 500 mA
	short-circuit proof $\cos \varphi = 1$; characteristic B16 at 600 A	16 A
	short-circuit proof $\cos \varphi = 0.5$ up to 0.7; characteristic B16 at 900 A	16 A
	Rated impulse withstand voltage U_{imp} contact-coil	6 kV
	Rated operational voltage U_e	250 V AC
Rated insulation voltage U_i		250 V AC
Protective separation (EN 50178)	between coil and contact	300 V AC
	between two contacts	300V AC
Making capacity	AC15, 250 V AC, 3 A (600 ops./h)	300.000 switching cycles
	DC13, L/R ≤ 150 ms, 24 V DC, 1 A (500 ops./h)	200.000 switching cycles
Breaking capacity	AC15, 250 V AC, 3 A (600 ops./h)	300.000 switching cycles
	DC13, L/R ≤ 150 ms, 24 V DC, 1 A (500 ops./h)	200.000 switching cycles
Incandescent lamp load	1000 W at 230/240 V AC	25.000 switching cycles
	500 W at 115/120 V AC	25.000 switching cycles
Fluorescent lamp load	10 x 58 W at 230/240 V AC with electrical control gear	25.000 switching cycles
	10 x 58 W at 230/240 V AC uncompensated	25.000 switching cycles
	1 x 58 W at 230/240 V AC conventional compensated	25.000 switching cycles
Switching frequency	mechanical operations	10×10^6
	switching frequency	10 Hz
	resistive load / lamp load	2 Hz
	inductive load	0.5 Hz
UL/CSA		
Continuous current at 240 V		10 A AC
Continuous current at 24 V		8 A DC
AC	Utilization category (Control Circuit Rating Codes)	B 300 Light Pilot Duty
	max. rated operational voltage	300 V AC
	max. continuous thermal current $\cos \varphi = 1$ at B 300	5 A
	max. making / breaking apparent power (Make/Break) $\cos \varphi \neq 1$ at B 300	3600/360 VA
DC	Utilization category (Control Circuit Rating Codes)	R 300 Light Pilot Duty
	max. rated operational voltage	300 V DC
	max. continuous thermal current at R 300	1 A
	max. making / breaking apparent power (Make/Break) at R 300	28/28 VA

6

Data at $T_a = 25\text{ °C}$ and rated values, if nothing else indicated.

Type	CL-LDT...
Output circuit - Transistor outputs	
Number	4
Rated operational voltage U_o	24 V DC
Operational voltage range	20.4-28.8 V DC
Residual ripple	-
Supply current	on „0“ signal typ. 18 mA / max. 32 mA on „1“ signal typ. 24 mA / max. 44 mA
Reverse voltage protection	yes (Attention: If supply voltage is reversed, applying voltage at the outputs, causes a short circuit.)
Electrical isolation	from voltage supply yes from the inputs yes from PC interface, memory module, CL-NET, CL-LINK yes
Rated operational current I_o on „1“ signal DC	max. 0.5 A
Lamp load without R_L	5 W (Q1-Q4)
Residual current on „0“ signal per channel	< 0.1 mA
Max. output voltage	on „0“ signal at external load < 10 M Ω 2.5 V on „1“ signal at $I_o = 0.5$ A $U = U_o - 1$ V
Short-circuit protection	thermal (Q1-Q4), (analysis results from diagnosis input I16)
Short-circuit tripping current for $R_L \leq 10$ m Ω	0.7 A $\leq I_o \leq 2$ A per output
Total short-circuit current	8 A
Peak short-circuit current	16 A
Thermal tripping	yes
Max. switching frequency with constant resistive load $R_L < 100$ k Ω (depending on active channels and their load)	40.000 switching cycles/h
Parallel connection of outputs	with resistive load, inductive load with external suppressor, combination within one group group 1: Q1-Q4 number of outputs max. 4 max. total current 2 A (Attention! Outputs must be actuated simultaneously and for the same length of time.)
Indication of operational states of the outputs	LCD-Display (if existing)
Inductive load ¹⁾ without external suppressor	
$T_{0.95} = 1$ ms, $R = 48$ Ω , $L = 16$ mH	utilization factor 0.25 g duty time 100 % max. switching frequency $f = 0.5$ Hz (max. duty time = 50 %) 1500 switching cycles
DC13, $T_{0.95} = 72$ ms, $R = 48$ Ω , $L = 1.15$ H	utilization factor 0.25 g duty time 100 % max. switching frequency $f = 0.5$ Hz (max. duty time = 50 %) 1500 switching cycles
$T_{0.95} = 15$ ms, $R = 48$ Ω , $L = 0.24$ H	utilization factor 0.25 g duty time 100 % max. switching frequency $f = 0.5$ Hz (max. duty time = 50 %) 1500 switching cycles
Inductive load ¹⁾ with external suppressor	
	demand factor 1 g duty time 100 % max. switching frequency max. duty time depends on suppressor

¹⁾ For inductive loading, without external suppression of the transistor outputs, the following applies:
 $T_{0.95}$ = time in ms, until 95 % of the steady-state current is achieved. $T_{0.95} \cdot 3 \times T_{0.65} = 3 \times L/R$.

Data transfer rate in the CL-NET network: bus lengths of 40 m and over only attainable with cables with additional cross-section and connection adapter.

Logic relays

Approximate dimensions

CL Range
Logic relays

CL-LSR, CL-LST

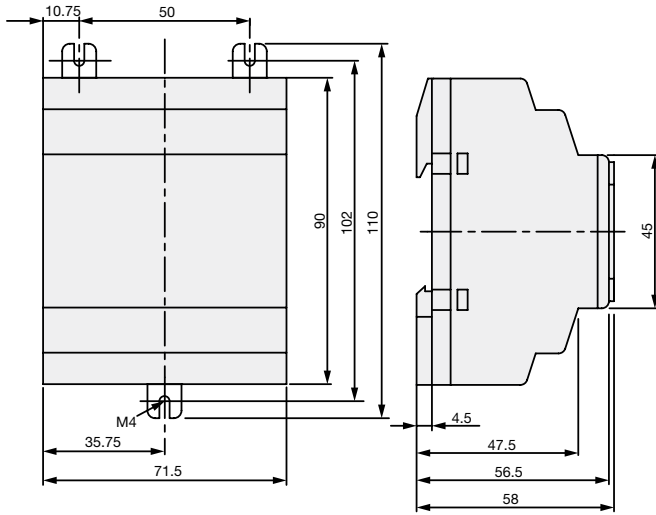

CL-LMR, CL-LMT

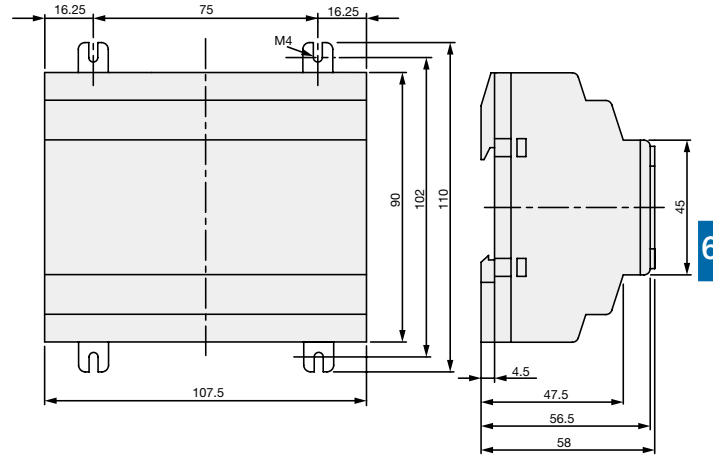

6

CL-LDD

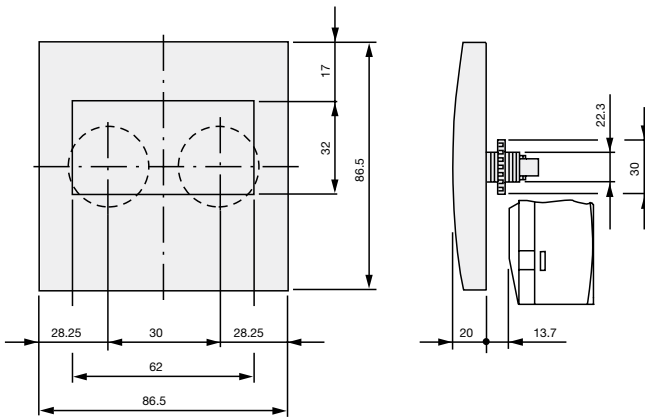

CL-LDD.K + CL-LDC.L. +
(CL-LDR or CL-LDT)

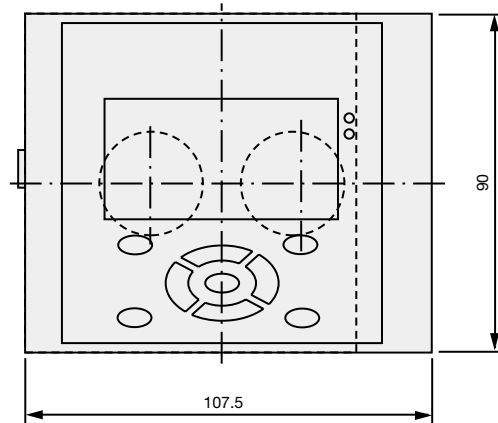

CL-LDR, CL-LDT

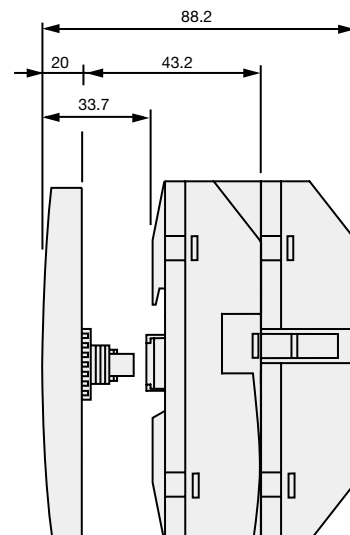
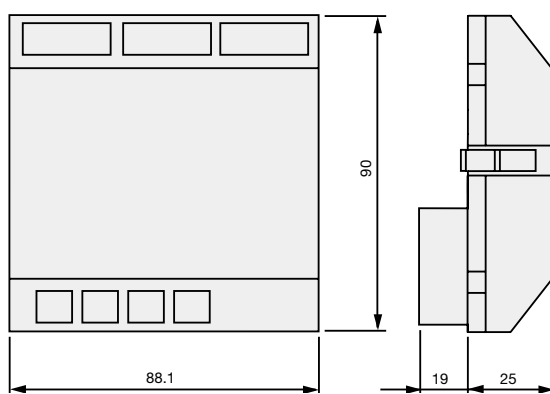

Logic relays

Approximate dimensions

CL-LER.20

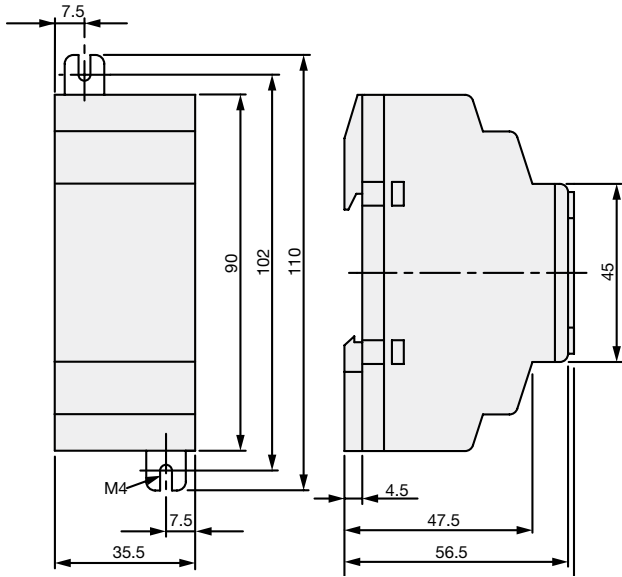

6

CL-LDC.S..

