

# Pro'sKit®

## MT-7625

### Optical Power Meter & Tone Probe Kits

# User's Manual

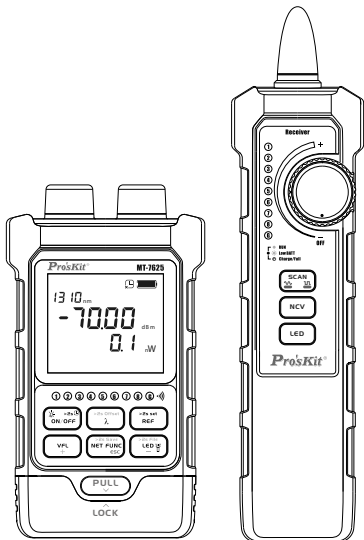

English

繁體中文

简体中文

# Pro'sKit®

## MT-7625

### Optical Power Meter & Tone Probe Kits

# User's Manual

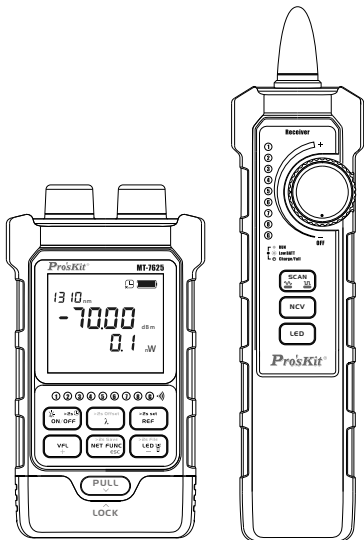

English

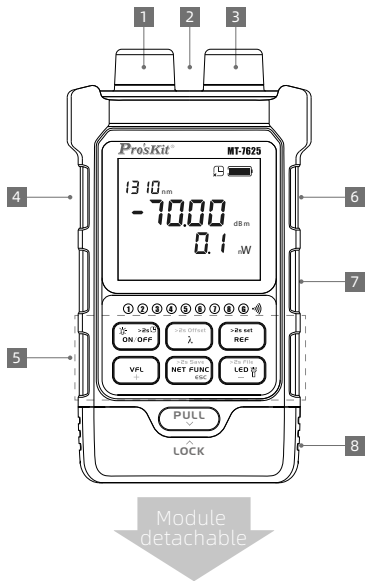

- 1 VFL Connector    2 LED Light    3 OPM Connector
- 4 RJ45 Socket(Continue and crimping test)
- 5 Keypad    6 RJ45 Socket(Network cable tracing)
- 7 Type-C Port    8 Network Cable Test Module

## Receiver

---

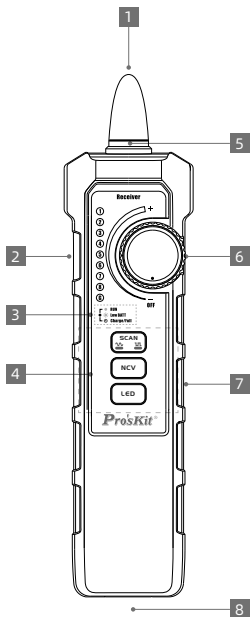

- |               |                |                    |
|---------------|----------------|--------------------|
| 1 Probe       | 2 Headset Jack | 3 Status Indicator |
| 4 Keypad      | 5 LED Light    | 6 Power Switch     |
| 7 Type-C Port | 8 RJ45 Socket  |                    |

## Display Description

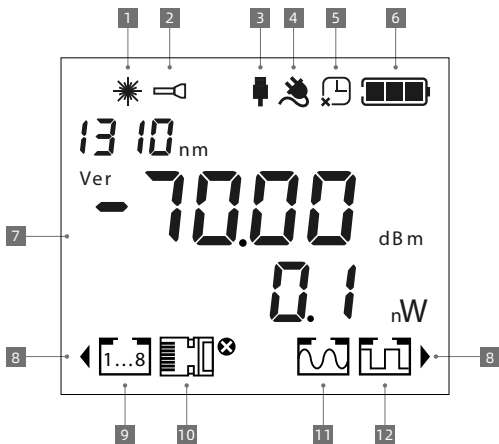

1 VFL

2 LED Light

3 USB

4 Power

5 Auto Power-off

6 Battery Level

7 OPM Information Area

8 Test Socket Position





9 RJ45 Cable Test

10 Network Cable Crimping

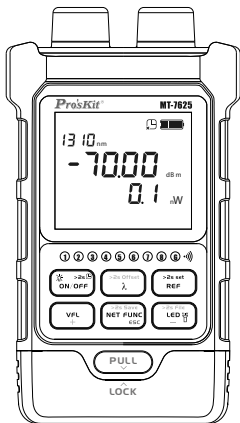
11 Cable tracing(analog)

12 Cable tracing(digital)





Short press " " to turn on the power with auto-off function, automatically shut down after 10 minutes of no operation. To turn off the auto-off function, long press " " to turn on the device in the off state. The " " icon lights up at the top, indicating that the auto-off function is turned off. After power on, short press " " to turn on/off backlight, long press to turn off the power. Long press " " to shut down the power in any interface.

## Charge(Host)

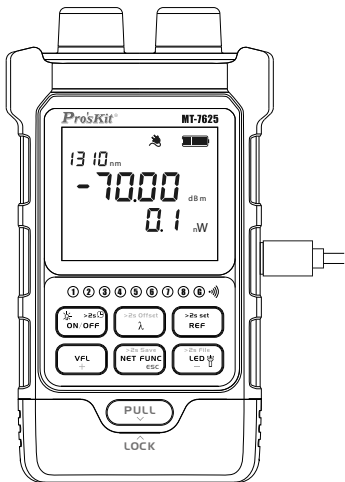
---



Use the recommended power adapter and cable to connect to the Type-c interface. The "  " icon lights up, indicating that the power supply is connected. The "  " icon displays dynamically increasing, and when fully charged, the "  " icon remains static.

\*Recommended power adapter specifications: 5V/1A

## Charge(Receiver)

---

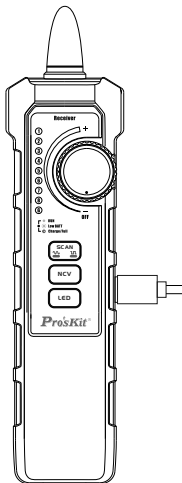

Use the recommended power adapter and cable to connect to the Type-c interface. The icon lights up, indicating that the power supply is connected.

- **RUN** Green light, battery power is normal.
- ☀ **Low BATT** The green light flashes, indicating low battery power.
- **Charge/Full** Red light, charging status.

\*Recommended power adapter specifications: 5V/1A



## Optical Power Meter

---

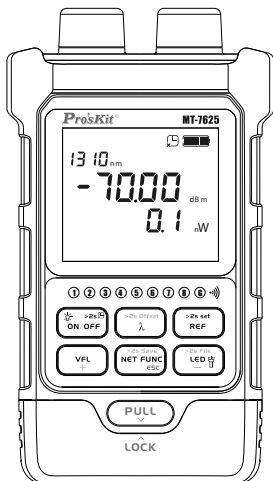



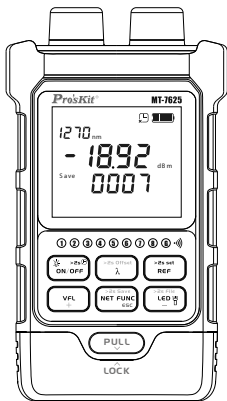

After power on, short press the "

to switch the measurement wavelength. The device supports measurement of 10 calibration wavelengths: 850nm, 980nm, 1270nm, 1300nm, 1310nm, 1490nm, 1550nm, 1577nm, 1625nm, 1650nm. Short press the "

to switch units and view the REF setting value. Long press to set the current measurement value as the new REF value.







- Storage: Long press "  " in the optical power meter interface to store the current measurement information, and the current storage serial number will be displayed on the interface. The device can store up to 500 pieces of data. After 500 pieces of data are exceeded, the first record will be overwritten.

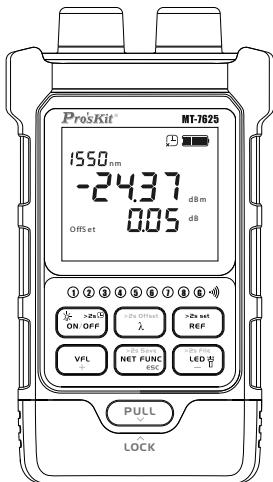



- View: Long press "  " in the optical power meter interface to enter the stored value viewing interface. Use the "  " and "  " to turn pages, and long press is supported to turn pages quickly. Short press the "  " to exit the storage interface.

## OPM Offset Setting





Long press " " to enter the offset setting interface, short press " " to switch wavelength, short press " ", and " " to adjust the set offset, the setting range is [-5, +5], short press " ", confirm the offset setting, and exit.

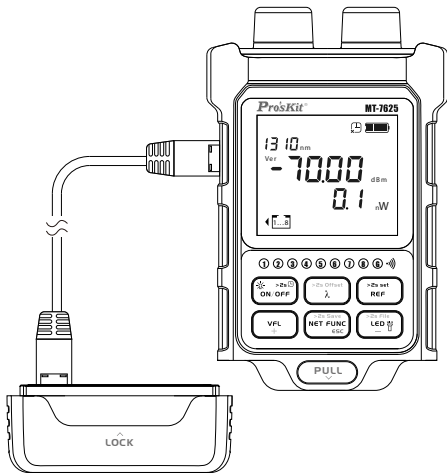

- Short press "  " to switch VFL output mode: CW/Glint/OFF. The "  " icon will be displayed in sync status.
- Short press "  " to turn on/off LED lighting. The "  " icon will be displayed in sync status.





Unplug the network cable test module, short press "  " to enable the network cable test, the "  " icon will display the synchronization status. Connect both ends of the network cable to the host and module respectively. You can judge whether the network cable is qualified based on the lighting status of the host UI (1,2,---8,G) and module indicators corresponding.

"  " flashes to indicate that the network cable is plugged into the RJ45 test socket on the left.

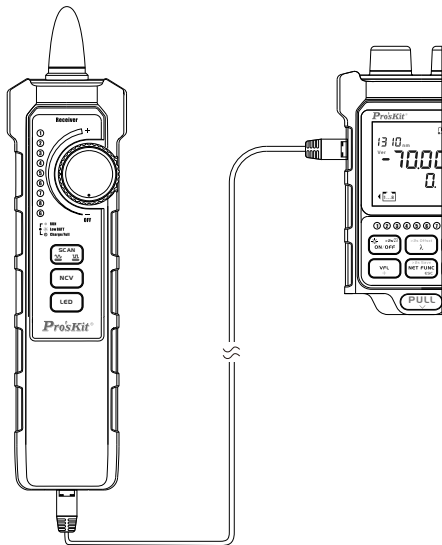

## Network Cable Test(Receiver)



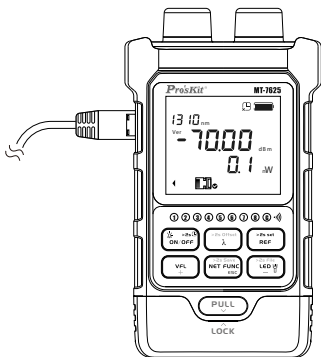

Short press "  " to enable the network cable test, and the "  " icon will display the synchronization status.

Connect both ends of the network cable to the host and module respectively. You can judge whether the network cable is qualified based on the lighting status of the host UI (1,2,---8,G) and module indicators corresponding.





Short press "  " twice to enable the network cable test crimping function, and the "  " icon will be displayed in sync status.

Connect the tested connector to the RJ45 test socket on the left side of the host. You can judge whether the network cable is qualified according to the lighting status of the host UI indicator. "  " lights up if the crimping test fails, and the LED light flashes corresponding to the core number of the failed crimping wire. "  " lights up and the crimping test is passed.

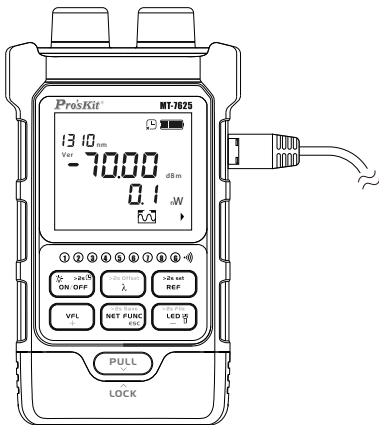
"  " flashes to indicate that the network cable is plugged into the RJ45 test socket on the left.



Short press "  " three times to turn on the cable tracing function (analog), the "  " icon will display the synchronization status, and the "  " LED will flash continuously.

Connect the cable connector to the RJ45 test socket on the right side of the host. At this time, the host setting of the cable tracing function is completed and to set the receiver.

"  " flashes to indicate that the network cable is plugged into the RJ45 test socket on the right.



## Network Cable Tracing-Receiver Settings (Analog)

---



The red indicator light is on, indicating that the receiver is in analog signal receiving mode, and the green indicator light is on, indicating that the receiver is in digital signal receiving mode.







Turn the receiver knob clockwise to turn the receiver on. Short press "SCAN" to turn on the cable tracing function (analog). At this time, the receiver will beep and the red backlight of the button will light up.

When the probe gradually approaches the test network cable, the receiver will emit regular beep reminders and the light ring above will flash. The adjustment knob on the receiver is used to adjust the sensitivity (clockwise to the end for the highest sensitivity).

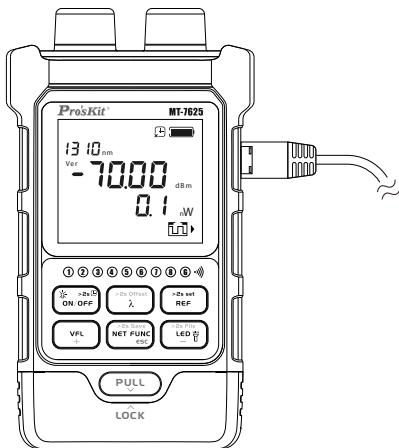
**▲ Note: When searching for cables in the network, due to the network switch (the transmitter transmits the signal and transmits it to other network cable ports through the internal circuit of the switch), several network cables close to the target network cable may have audio signals. In this case, you can try to turn the receiver sensitivity knob counterclockwise to reduce the receiving sensitivity to find the target network cable.**

**Note: The modes of the host and receiver need to be consistent, otherwise the signal will not be received.**



Short press "  " four times to turn on the cable tracing function (digital), the "  " icon will display the synchronization status, and the "  " LED will flash continuously.

Connect the cable connector to the RJ45 test socket on the right side of the host. At this time, the host setting of the cable tracing function is completed and to set the receiver.

"  " flashes to indicate that the network cable is plugged into the RJ45 test socket on the right.



Turn the receiver knob clockwise to turn the receiver on. Short press "  " to turn on the cable tracing function (digital). At this time, the receiver will beep and the green backlight of the button will light up.

When the probe gradually approaches the test network cable, the receiver will emit regular beep reminders and the light ring above will flash. The adjustment knob on the receiver is used to adjust the sensitivity (clockwise to the end for the highest sensitivity).

**▲ Note: When searching for cables in the network, due to the network switch (the transmitter transmits the signal and transmits it to other network cable ports through the internal circuit of the switch), several network cables close to the target network cable may have audio signals. In this case, you can try to turn the receiver sensitivity knob counterclockwise to reduce the receiving sensitivity to find the target network cable.**

**Note: The modes of the host and receiver need to be consistent, otherwise the signal will not be received.**

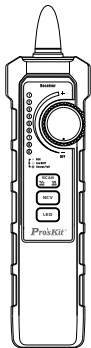

Turn the receiver knob clockwise to turn the receiver on. Short press " **NCV** " to turn on the NCV mode. When a voltage greater than the threshold is detected, the receiver horn will make a "beep" sound, and the ring light on the probe will flash.

**Note: Nearby external interference sources (such as the charger without grounding, etc.) may trigger non-contact voltage detection.**

**Even if there is no indication, voltage may still be present. Don't rely solely on a non-contact voltage detector to determine whether voltage is present on a wire. Detection operations may be affected by factors such as socket design, insulation thickness and type.**

## Receiver-LED light function

---

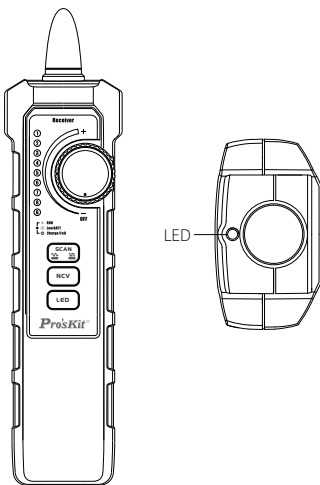

Turn the receiver knob clockwise to turn the receiver on. Short press "  " to turn on the LED light function.

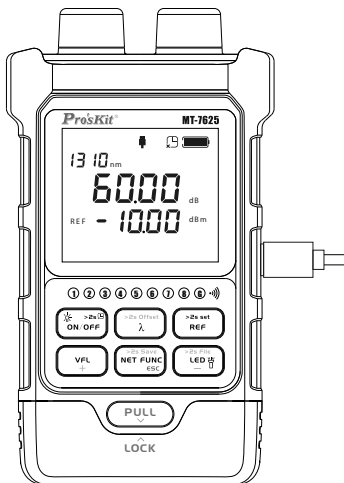

Communication: Use a USB-C data cable to connect the host to the PC, install the communication software on the PC to perform data transfer operations. The "  " icon flashes, indicating that communication is in progress.

Software download link:

<https://www.prokits.com.tw/Product/MT-7625/>

# Specification

---

## Optical Power Meter Specifications and Functions

Detector Type	InGaAs
Wavelength	700-1700nm
Response Range	2.5mm universal connector
OPM Connector	
Measurement Wavelengths	850/980/1270/1300/1310/1490/1550/1577/1625/ 1650nm
Measurement Range	-70~+10dBm
Accuracy*	(1550,1310nm) $\pm$ 0.2dB, (850nm,980nm,1300nm,1490 nm,1625nm,1650nm) $\pm$ 0.3dB, (1270nm,1577nm) $\pm$ 1dB
Resolution	0.01dB
Unit	dB,dBm, mW, uW, nW
Modulation	270/330/1k/2kHz (Only for Pro'sKit Light Source products)
Data Storage	500 groups
Wavelength Memory	Yes
User Self-calibration	Yes
REF	Yes
Back Light	Yes

## Visual Fault Locator Functions

Output Power	15mW
Testing Distance**	10-12km @SM
VFL Connector	2.5mm universal connector
Wavelength	650 $\pm$ 20nm
Operation Mode	CW/2Hz Glint

## Network Line Sequence Function

Applicable network	UTP/STP Network Cable
Cable Interface	RJ45 (8P8C+G)
Test Type	Network Cable Sequence
Test Distance	600m

# Specification

---

## Audio Hunt function

Hunting Function	Analog & Digital Mode
------------------	-----------------------

---

Detection Frequency	455kHz
---------------------	--------

---

Detection Distance	600m
--------------------	------

---

## Line Pressing Function

Crimp Detection	RJ45 8pin: > 10cm
-----------------	-------------------

---

Illumination	LEDx1
--------------	-------

---

Auto Power-off	Yes(no operation in 10 minutes)
----------------	---------------------------------

---

Low Battery Indicator	Battery level
-----------------------	---------------

---

Charging Socket	Type-C
-----------------	--------

---

Charging time	< 3hours
---------------	----------

---

Working Time	>30 hours(only OPM)
--------------	---------------------

---

Power Source	Li-ion 3.7V/450mAh
--------------	--------------------

---

Operating Temperature	-10~50°C
-----------------------	----------

---

Humidity	<90%RH
----------	--------

---

Size	114*65*29mm
------	-------------

---

Weight	120g
--------	------

---

## Receiver Specifications and Functions

Power Switch	Knob Operation
--------------	----------------

---

Function Selection	Silicone ButtonX3
--------------------	-------------------

---

Response Frequency	455KHz
--------------------	--------

---

Volume	≥85dB
--------	-------

---

Receiver Signal	Analog/ Digital
-----------------	-----------------

---

Speaker Audio	Analog Detection (633Hz/833Hz) & Digital Detection(833Hz/1500Hz)
---------------	---

---

Sensitivity	Knob Adjustment
-------------	-----------------

---

Test Interface	RJ45× 1
----------------	---------

---

Line Sequence	LED ×9
---------------	--------

---

Indicator	
-----------	--

---

Status Indicator	LED× 3
------------------	--------

---



## Specification

---

### Non-contact Electricity Test Function

Non-contact Voltage AC 90V-1000V  
Detection

---

Indicator Light LED ×1 (ring)

---

Speaker Audio 1500HZ

---

### LED Light Functions

Illumination LED×1

---

Headset Jack  $\Phi$ 3.5mm×1

---

Charging Socket Type-C

---

Power Source Li-ion 3.7V 450mAh

---

Working Current  $\leq$ 250mA

---

Size 180\*45\*26mm

---

Weight 100g

---

Packing List Type-C Charging Cable x1, Headset x1, RJ45 Patch-cord x1, Alligator Clip Patch-cord x1, Bag, User Manual

---

\*At 23°C±2°C, 40%-60%RH, with standard testing fiber.

Accuracy range: +3dBm~-60dBm, other references are as follows:

±0.8dB: +3dBm~+6dBm, -60dBm~-65dBm@1550nm

±3.0dB: +6dBm~+10dBm, -65dBm~-70dBm@1550nm

\*\* Test distance will be influenced by environmental conditions and visual sensitivity.

### General maintenance

The fiber optic connector should avoid contact with hard objects and keep clean. When storing, keep it ventilated and dry to avoid moisture. When not in use for a long time, charge it once every 3 months to 50%-80% of the battery.

---

## Troubleshooting

Failure	Failure Cause	Solution
Cannot power on	battery power is too low	Charge the battery
Immediately shutdown after power on	Low battery	Charge the battery
The operation is invalid	The instrument program is disordered	turn on the device again
improper measurement error	The face of the light port is dirty	Clean the fiber optic connector

# Pro'sKit®

## 多功能光功率計/MT-7625

### Optical Power Meter & Tone Probe Kits

### 操作手冊

### User's Manual

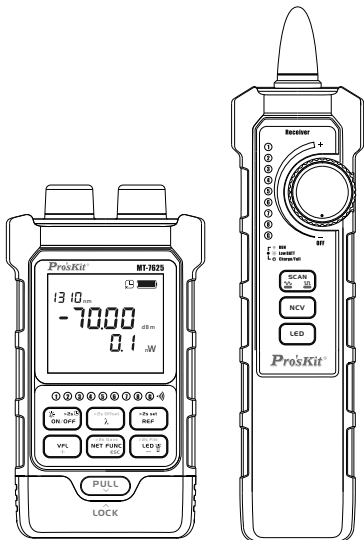

繁體中文

# 主機

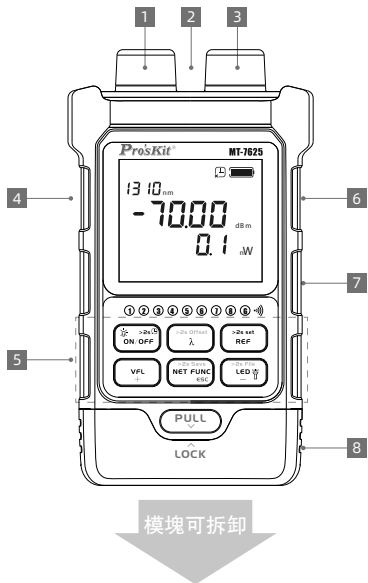

- |   |                   |   |        |   |       |
|---|-------------------|---|--------|---|-------|
| 1 | VFL接口             | 2 | LED燈   | 3 | OPM接口 |
| 4 | RJ45測試插座(對綫、壓綫測試) | 5 | 按鍵區    |   |       |
| 6 | RJ45尋綫測試插座        | 7 | Type-C |   |       |
| 8 | 網綫測試模塊            |   |        |   |       |

# 接收器

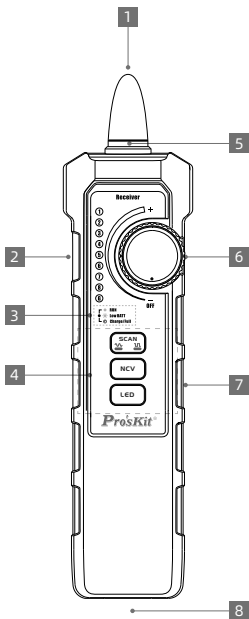

- |   |        |   |          |   |       |
|---|--------|---|----------|---|-------|
| 1 | 探頭     | 2 | 耳機孔      | 3 | 狀態指示燈 |
| 4 | 按鍵區    | 5 | LED環燈    | 6 | 開關旋鈕  |
| 7 | Type-C | 8 | RJ45測試插座 |   |       |



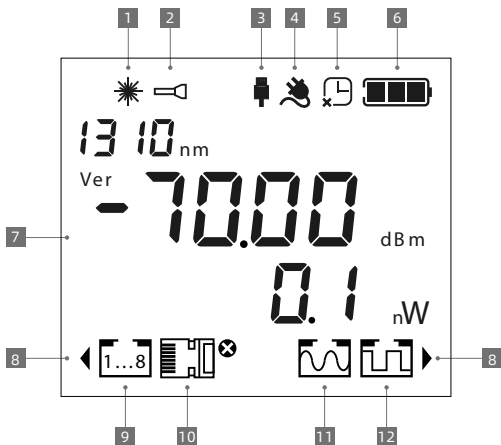

## 顯示說明

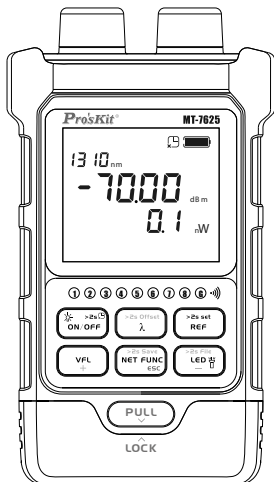

- |    |          |    |          |
|----|----------|----|----------|
| 1  | VFL圖標    | 2  | LED圖標    |
| 3  | USB通信圖標  | 4  | 電源圖標     |
| 5  | 關閉省電模式圖標 | 6  | 電量指示圖標   |
| 7  | 光功率計信息區域 | 8  | 測試插座位置   |
| 9  | 網綫對綫功能圖標 | 10 | 網綫壓綫功能圖標 |
| 11 | 尋綫功能(模擬) | 12 | 尋綫功能(數字) |



## 主機開關機

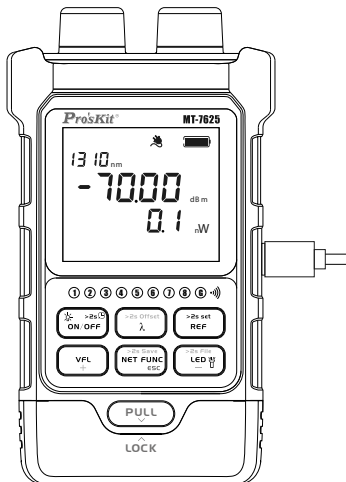

短按“ ”鍵開機，並且自動開啓省電功能，無操作10分鐘自動關機。若要關閉省電功能，需在關機狀態下，長按“ ”開機。“ ”圖標在頂部亮起，表示省電功能關閉。開機后短按“ ”鍵開啓或關閉屏幕背光。在任意界面下長按“ ”鍵關機。

## 主機充電



使用推薦規格的電源適配器及纜材接入Type-c接口，“”圖標亮起，表示電源已連接。“”圖標顯示動態遞增，充滿電時“”圖標靜止。

\*推薦的電源適配器規格：5V/1A



## 接收器充電

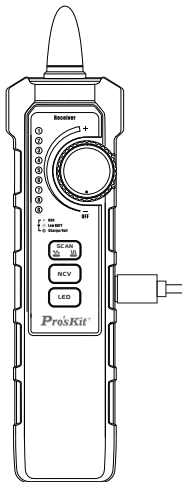

使用推薦規格的電源適配器及纜材接入Type-c接口, 指示燈亮起, 表示電源已連接。

- **RUN** 綠燈, 電池電力正常
- ☀ **Low BATT** 綠燈閃爍, 電池低電量提示
- **Charge/Full** 紅色, 充電狀態

\*推薦的電源適配器規格: 5V/1A

## 光功率計

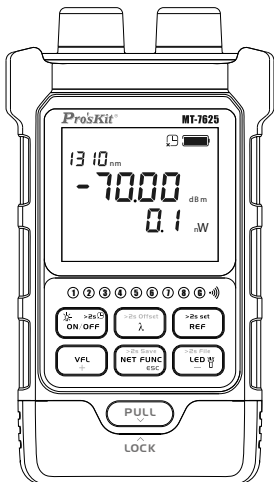

開機后進入光功率計界面，短按“ ”鍵切換測量波長，設備支持10個校准波長的測量：850nm、980nm、1270nm、1300nm、1310nm、1490nm、1550nm、1577nm、1625nm、1650nm。短按“ ”鍵切換單位和查看REF設定值，長按可將當前測量值設定為新的REF值。

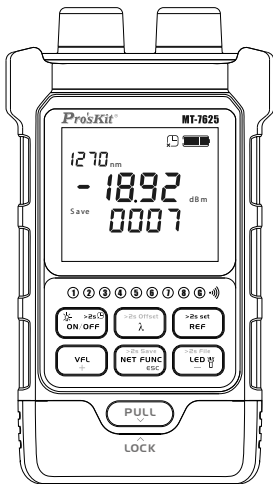



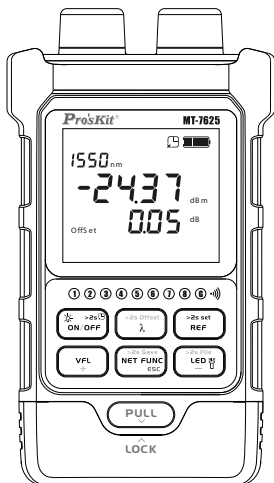

• 存儲：光功率計界面下長按 “” 鍵可存儲當前測量信息，界面上會顯示當前存儲序號。設備可存儲多達500條數據，超過500條之后會覆蓋第一條記錄。

• 查看：光功率計界面下長按 “” 鍵進入存儲值查看界面。使用 “”、 “” 鍵進行翻頁操作，支持長按快速翻頁。短按 “” 鍵退出存儲界面。



## 光功率偏移量設置





長按 “” 鍵進入偏移量設置界面，短按 “” 鍵切換波長，短按 “” 鍵， “” 鍵調整設置偏移量，設置範圍【-5，+5】，短按 “” 鍵，確認偏移設置，并退出。

## VFL/LED手電筒

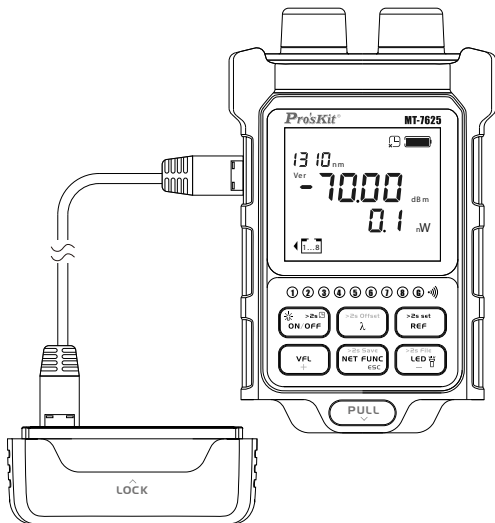

- 短按 “  ” 鍵切换VFL状态：开启/闪烁/关闭。  
“ \* ” 图标会同步状态显示。
- 短按 “  ” 键切换LED手电筒状态：开启/关闭。  
“  ” 图标会同步状态显示。



拔下網綫測試模塊，短按“”鍵開啓網綫測試對綫功能，“”圖標會同步狀態顯示。

將網綫兩端分別接入主機和模塊，根據主機UI和模塊指示燈點亮狀態可判斷網綫是否合格。

“”閃爍提示網綫插入左側RJ45測試插座。

## 網綫測試-對綫(接收器)

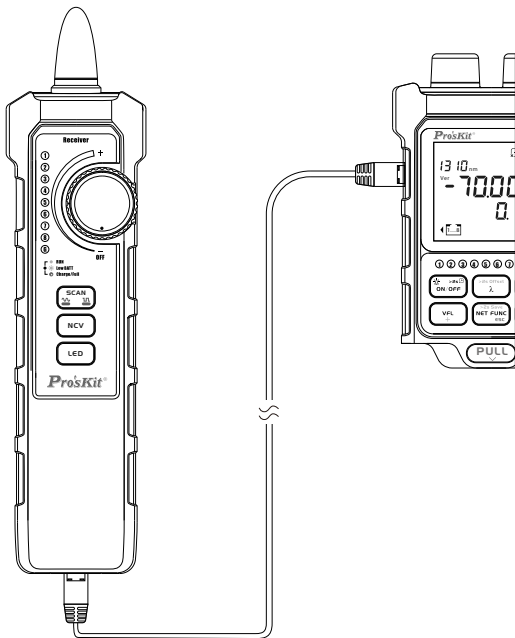



短按 “” 鍵開啓網綫測試對綫功能，

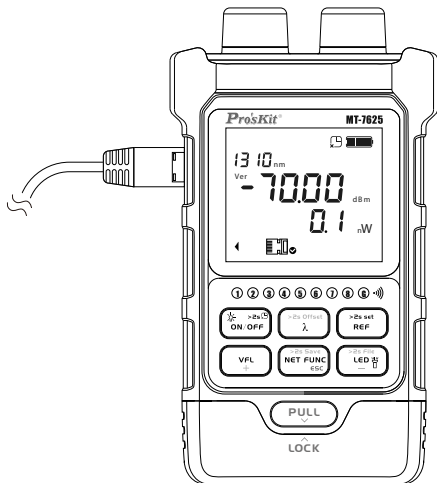

“” 圖標會同步狀態顯示。

將網綫兩端分別接入主機和模塊，根據主機UI和模塊指示燈點亮狀態可判斷網綫是否合格。



短按兩次“”鍵開啓網線測試壓綫功能，“”圖標會同步狀態顯示。

將網線待測水晶頭接入主機左側RJ45測試插座，根據主機UI指示燈點亮狀態可判斷網線是否合格。

“”亮起壓接測試不合格，對應壓接失敗的綫芯序號LED燈閃爍。“”亮起壓接測試合格。

“”閃爍提示網線插入左側RJ45測試插座。



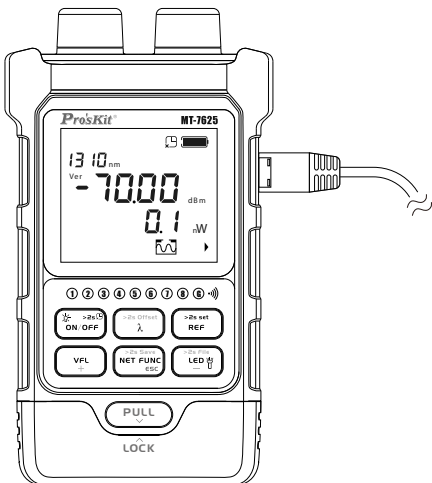

必須配合接收器模式使用。短按三次“”鍵開啓尋綫功能(模擬)，圖標會同步狀態顯示，“”LED會連續閃爍。

將網綫待測水晶頭接入主機右側RJ45測試插座，此時尋綫功能主機設置完成，開始設置接收器。

“”閃爍提示網綫插入右側RJ45測試插座。

## 網綫測試-尋綫功能接收器設置(模擬)



紅色指示燈亮，表示接收器在模擬信號接收模式，綠色指示燈亮，表示接收器在數字信號接收模式。

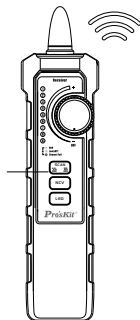





順時針旋轉接收器旋鈕，打開接收器。短按“”鍵開啓尋綫功能(模擬)，此時會接收器會發出蜂鳴聲，且按鈕紅色背光亮起。

當探測器逐漸靠近測試網綫時，接收器會發出規律的蜂鳴提醒，並且上面的燈環會閃爍。接收器上的調節旋鈕用于調節靈敏度大小(順時針到底靈敏度最大)。

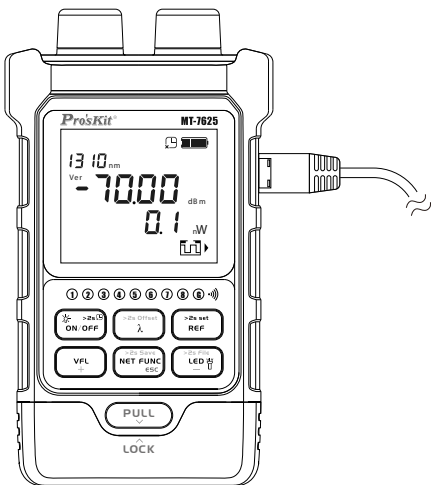
▲注意：在網絡中尋綫時，因為網絡交換機原因(發射器發射信號，通過交換機內部電路傳輸到其它網綫端口)，與目標網綫臨近的幾根網綫可能都有音頻信號，此時，可以嘗試逆時針旋轉接收器靈敏度旋鈕，降低接收靈敏度的方法來查找目標網綫。

注意：主機和接收器的模式需要一致，否則接收不到信號。



必須配合接收器模式使用。短按四次“”鍵開啓尋綫功能(數字)，“”圖標會同步狀態顯示，“”LED會連續閃爍。

將網綫待測水晶頭接入主機右側RJ45測試插座，此時尋綫功能主機設置完成，開始設置接收器。

“”閃爍提示網綫插入右側RJ45測試插座。

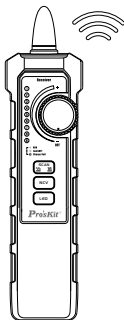



順時針旋轉接收器旋鈕，打開接收器。短按“”鍵開啓尋綫功能(數字)，此時會接收器會發出蜂鳴聲，且按鈕綠色背光亮起。

當探測器逐漸靠近測試網綫時，接收器會發出規律的蜂鳴提醒，並且上面的燈環會閃爍。接收器上的調節旋鈕用于調節靈敏度大小(順時針到底靈敏度最大)。

▲注意：在網絡中尋綫時，因為網絡交換機原因(發射器發射信號，通過交換機內部電路傳輸到其它網綫端口)，與目標網綫臨近的幾根網綫可能都有音頻信號，此時，可以嘗試逆時針旋轉接收器靈敏度旋鈕，降低接收靈敏度的方法來查找目標網綫。

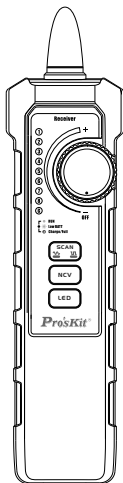
注意：主機和接收器的模式需要一致，否則接收不到信號。



順時針旋轉接收器旋鈕，打開接收器。短按 “  ” 鍵開啓NCV模式，當探測到大於閾值電壓時，接收器喇叭發出“滴滴聲”，並且探頭上環燈會閃爍。

注意：臨近的外部干擾源（如無接地的充電器等），可能會觸發非接觸電壓的探測。

即使沒有指示，電壓仍然可能存在。不要僅僅依靠非接觸電壓探測器來判斷導線是否存在電壓。探測操作可能會受到插座設計、絕緣厚度及類型不同等因素的影響。

## 接收器-LED照明功能

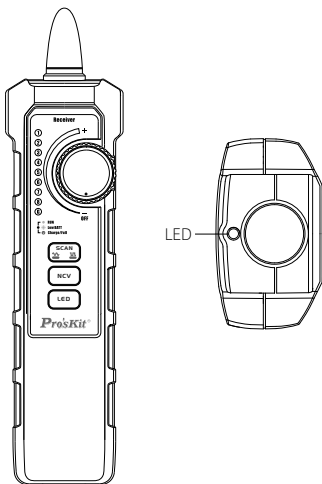

順時針旋轉接收器旋鈕，打開接收器。短按 “ LED ” 鍵開啓LED照明功能。

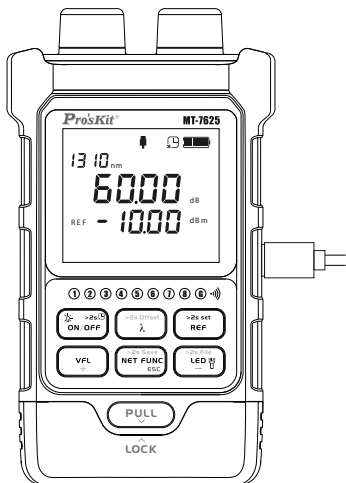

PC端通信：使用USB-C數據綫將主機連接到PC端，在PC端安裝上位機軟件以進行數據通信相關操作，“”圖標閃爍，表示正在通信中。

軟件下載鏈接：

<https://www.prokits.com.tw/Product/MT-7625/>

## 產品規格

### 光功率計主機規格及功能

探測器類型	InGaAs
波長響應範圍	700-1700nm
功率計接口	2.5mm 通用接口
測量波長	850/980/1270/1300/1310/1490/1550/1577/1625/1650nm
測量範圍	-70~+10dBm
準確度*	(1550,1310nm) ± 0.2dB, ( 850nm,980nm,1300nm,1490nm,1625nm,1650nm) ± 0.3dB, (1270nm,1577nm) ± 1dB
分辨率	0.01dB
顯示單位	dB, dBm, mW, uW, nW
頻率識別	270/330/1K/2KHz( 僅針對寶工光源產品)
數據存儲	500 組
波長記憶	Yes
用戶自校准	Yes
相對值測量	Yes
屏幕背光	Yes
紅光功能	
輸出功率	15mW
測試距離**	10-12km @SM
紅光源接口	2.5mm 通用接口
紅光波長	650 ± 20nm
輸出模式	CW/2Hz Glint
網絡綫序功能	
適用網絡	UTP/STP 網絡綫
網綫接口	RJ45 (8P8C+G)
測試類型	網綫順序
測試距離	600m
音頻尋綫功能	
尋綫功能	模擬 & 數字模式
探測頻率	455KHz
探測距離	600m



## 產品規格

### 壓綫功能

壓接檢測 RJ45 8pin: >10cm

輔助照明 LEDx1

自動關機 可選(10分鐘內無操作)

電池低電量 電池電量

充電接口 Type-C

充電時間 <3hours

工作時間 >30 hours(功率計模式)

電池 聚合物鋰電池3.7V/450mAh

使用溫度 -10~50℃

環境濕度 <90%RH

尺寸 114\*65\*29mm

重量 120g

### 接收器功能及規格

電源開關 旋鈕操作

功能選擇 硅膠按鍵X3

響應頻率 455KHz

音量 > 85dB

接收器信號 模擬/數字

喇叭音頻 模擬探測(633Hz/833Hz) & 數字探測(833Hz/1500Hz)

靈敏度 旋鈕調節

測試接口 RJ45 × 1

綫序指示燈 LED × 9

狀態指示燈 LED × 3

### 非接觸驗電功能

非接觸電壓檢測 AC 90V-1000V

指示燈 LED × 1(環形)

喇叭音頻 1500HZ

### 手電筒功能

輔助照明 LED × 1

耳機插孔  $\Phi$ 3.5mm × 1

## 產品規格

充電接口	Type-C
電池	聚合物鋰電池 3.7V 450mAh
工作電流	< 250mA
尺寸	180*45*26mm
重量	100g
配件	Type-C充電線x1、耳機x1、RJ45跳線x1、RJ45鱈魚夾跳線x1、牛津布包、說明書

\*測試條件：23℃ ± 2℃，40%~60%RH，使用標準測試綫。

準確度範圍：+3dBm~-60dBm，其餘參考如下：

± 0.8dB：+3dBm~-6dBm，-60dBm~-65dBm@1550nm

± 3.0dB：+6dBm~+10dBm，-65dBm~-70dBm@1550nm

\*\* 測試距離受環境條件及視覺敏感度影響。

### 一般維護

光纖連接適配器應避免與硬物接觸，並保持清潔。存放時應通風干燥，避免受潮。長期不使用時，每隔3個月充一次電，充入50%~80%的電量。

### 用戶可處理的故障

故障名	故障原因	處理辦法
不能開機	電池沒電	給電池充電
開機后馬上關機	電池電量低	給電池充電
開機后操作均無效	設備程序紊亂	重新開機
測量誤差大	光口端面髒污	清潔光口

# Pro'sKit®

## 多功能光功率计/MT-7625

### Optical Power Meter & Tone Probe Kits

### 操作手册

### User's Manual

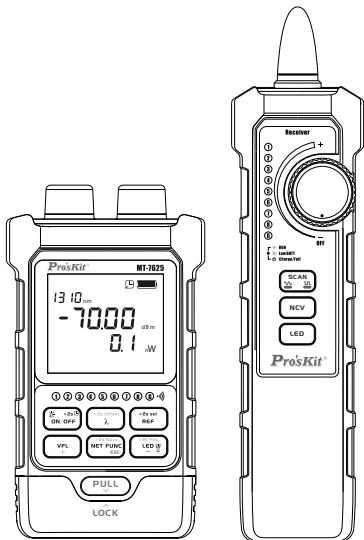

简体中文

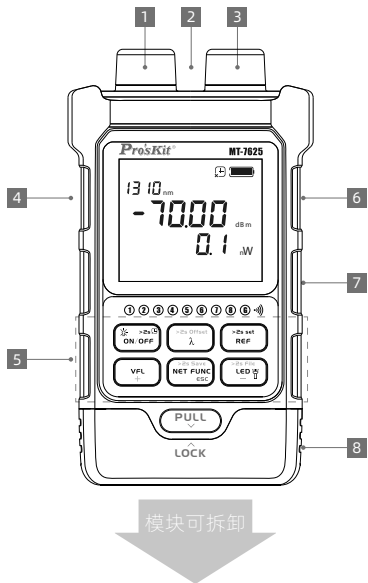

- |   |                   |   |        |   |       |
|---|-------------------|---|--------|---|-------|
| 1 | VFL接口             | 2 | LED灯   | 3 | OPM接口 |
| 4 | RJ45测试插座(对线、压线测试) | 5 | 按键区    |   |       |
| 6 | RJ45寻线测试插座        | 7 | Type-C |   |       |
| 8 | 网线测试模块            |   |        |   |       |

# 接收器

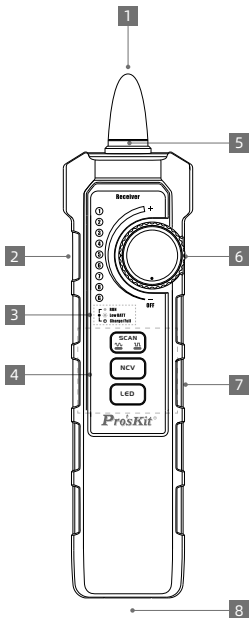



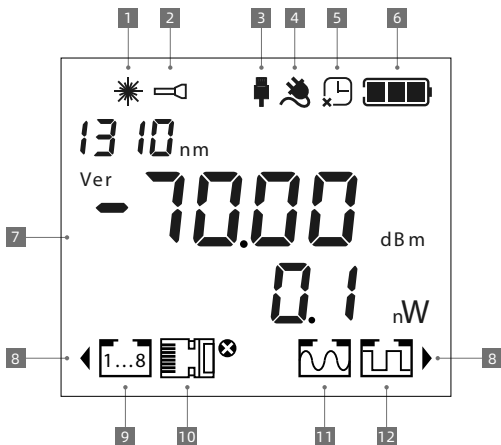



- |   |        |   |          |   |       |
|---|--------|---|----------|---|-------|
| 1 | 探头     | 2 | 耳机孔      | 3 | 状态指示灯 |
| 4 | 按键区    | 5 | LED环灯    | 6 | 开关旋钮  |
| 7 | Type-C | 8 | RJ45测试插座 |   |       |

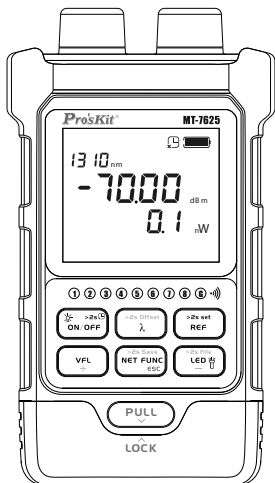

- |    |          |    |          |
|----|----------|----|----------|
| 1  | VFL图标    | 2  | LED图标    |
| 3  | USB通信图标  | 4  | 电源图标     |
| 5  | 关闭省电模式图标 | 6  | 电量指示图标   |
| 7  | 光功率计信息区域 | 8  | 测试插座位置   |
| 9  | 网线对线功能图标 | 10 | 网线压线功能图标 |
| 11 | 寻线功能(模拟) | 12 | 寻线功能(数字) |



## 主机开关机

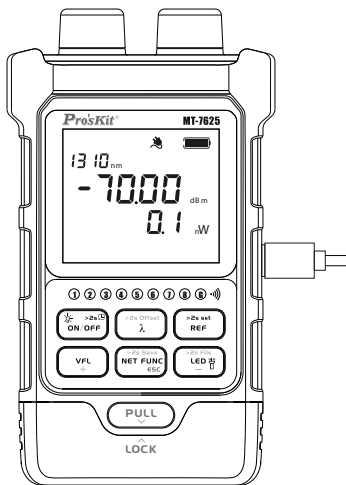

短按 “  ” 键开机，并且自动开启省电功能，无操作10分钟自动关机。若要关闭省电功能，需在关机状态下，长按 “  ” 键开机。“  ” 图标在顶部亮起，表示省电功能关闭。开机后短按 “  ” 键开启或关闭屏幕背光。在任意界面下长按 “  ” 键关机。

## 主机充电



使用推荐规格电源适配器及线材接入Type-c接口，“”图标亮起，表示电源已连接。“”图标显示动态递增，充满电时“”图标静止。

\*推荐的电源适配器规格：5V/1A



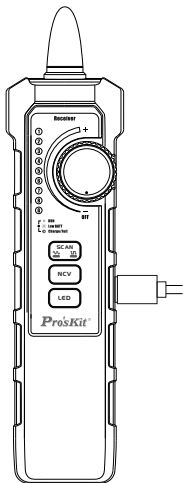



使用推荐规格电源适配器及线材接入Type-c接口,指示灯亮起,表示电源已连接。

- **RUN** 绿灯, 电池电力正常
- ☀ **Low BATT** 绿灯闪烁, 电池低电量提示
- **Charge/Full** 红色, 充电状态

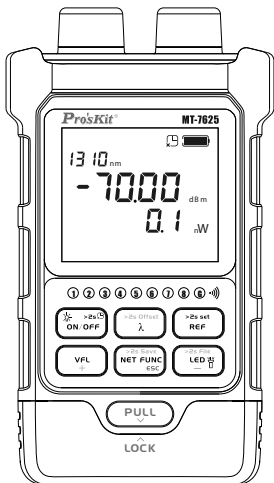
\*推荐的电源适配器规格: 5V/1A



开机后进入光功率计界面，短按“”键切换测量波长，设备支持10个校准波长的测量：850nm、980nm、1270nm、1300nm、1310nm、1490nm、1550nm、1577nm、1625nm、1650nm。短按“”键切换单位和查看REF设定值，长按可将当前测量值设定为新的REF值。

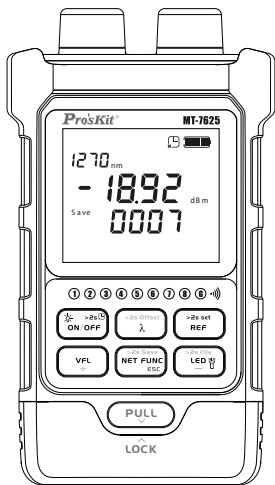





- 存储：光功率计界面下长按 “” 键可存储当前测量信息，界面上会显示当前存储序号。设备可存储多达500条数据，超过500条之后会覆盖第一条记录。

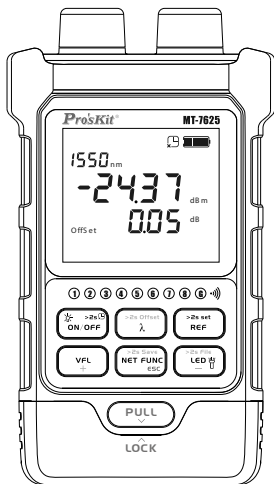



- 查看：光功率计界面下长按 “” 键进入存储值查看界面。使用 “”、“” 键进行翻页操作，支持长按快速翻页。短按 “” 键退出存储界面。

## 光功率偏移量设置



长按 “  ” 键进入偏移量设置界面，短按 “  ” 键切换波长，短按 “  ” 键，“  ” 键调整设置偏移量，设置范围【-5, +5】，短按 “  ” 键，确认偏移设置，并退出。



- 短按 “  ” 键切换VFL状态：开启/闪烁/关闭。  
“  ” 图标会同步状态显示。
- 短按 “  ” 键切换LED手电筒状态：开启/关闭。“  ” 图标会同步状态显示。

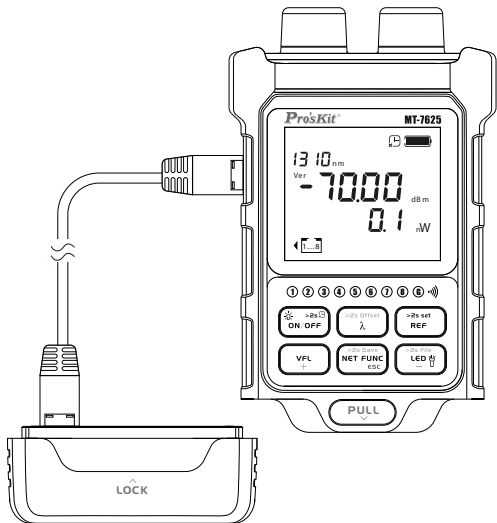

拨下网线测试模块，短按“**NET FUNC**”键开启网线测试对线功能，“**1...8**”图标会同步状态显示。

将网线两端分别接入主机和模块，根据主机UI和模块指示灯点亮状态可判断网线是否合格。

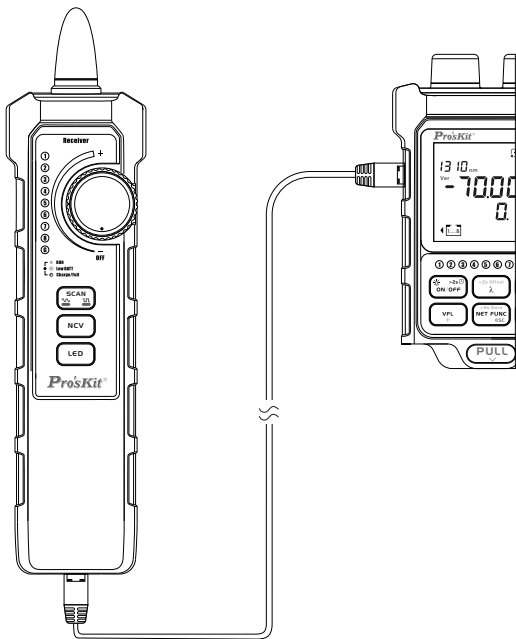

“**◀**”闪烁提示网线插入左侧RJ45测试插座。



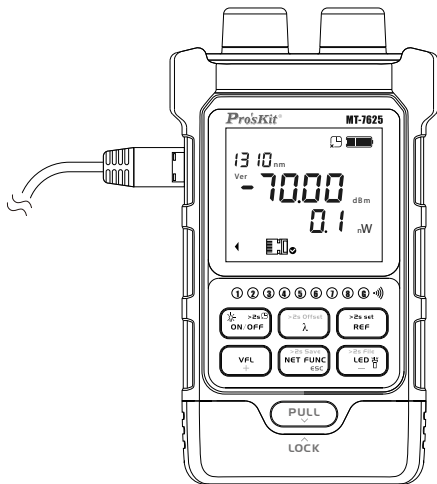

短按 “**NET FUNC**” 键开启网线测试对线功能，“**1...8**” 图标会同步状态显示。

将网线两端分别接入主机和模块，根据主机UI和模块指示灯点亮状态可判断网线是否合格。







短按两次“”键开启网线测试压线功能，“”图标会同步状态显示。

将网线待测水晶头接入主机左侧RJ45测试插座，根据主机UI指示灯点亮状态可判断网线是否合格。“”亮起压接测试不合格，对应压接失败的线芯序号LED灯闪烁。“”亮起压接测试合格。

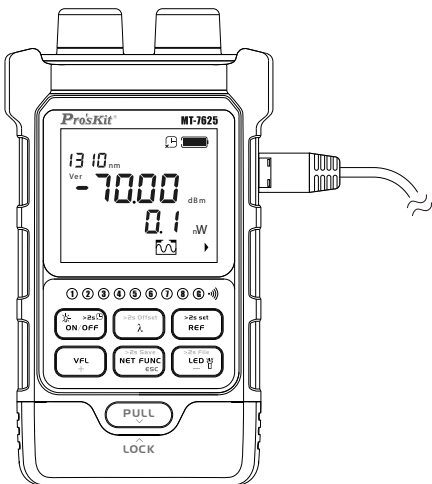
“”闪烁提示网线插入左侧RJ45测试插座。





必须配合接收器模式使用。短按三次 “” 键开启寻线功能(模拟), “” 图标会同步状态显示, “” LED会连续闪烁。

将网线待测水晶头接入主机右侧RJ45测试插座, 此时寻线功能主机设置完成, 开始设置接收器。

“” 闪烁提示网线插入右侧RJ45测试插座。



红色指示灯亮，表示接收器在模拟信号接收模式，绿色指示灯亮，表示接收器在数字信号接收模式。



顺时针旋转接收器旋钮，打开接收器。短按“”键开启寻线功能(模拟)，此时接收器会发出蜂鸣声，且按钮红色背光亮起。

当探测器逐渐靠近测试网线时，接收器会发出规律的蜂鸣提醒，并且上面的灯环会闪烁。接收器上的调节旋钮用于调节灵敏度大小（顺时针到底灵敏度最大）。

**▲注意：在网络中寻线时，因为网络交换机原因（发射器发射信号，通过交换机内部电路传输到其它网线端口），与目标网线临近的几根网线可能都有音频信号，此时，可以尝试逆时针旋转接收器灵敏度旋钮，降低接收灵敏度的方法来查找目标网线。**

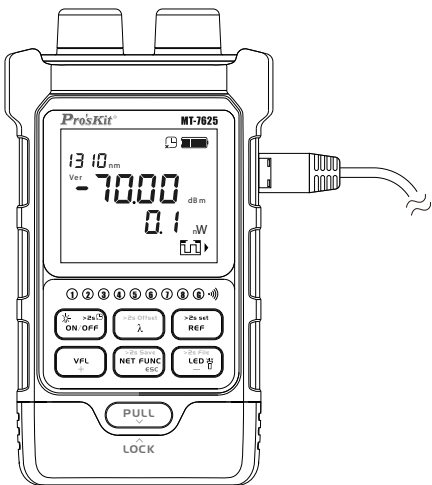
**注意：主机和接收器的模式需要一致，否则接收不到信号。**



必须配合接收器模式使用。短按四次 “” 键开启寻线功能(数字), “” 图标会同步状态显示, “” LED会连续闪烁。

将网线待测水晶头接入主机右侧RJ45测试插座, 此时寻线功能主机设置完成, 开始设置接收器。

“” 闪烁提示网线插入右侧RJ45测试插座。

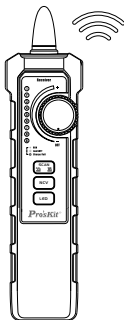

顺时针旋转接收器旋钮，打开接收器。短按“”键开启寻线功能(数字)，此时接收器会发出蜂鸣声，且按钮绿色背光亮起。

当探测器逐渐靠近测试网线时，接收器会发出规律的蜂鸣提醒，并且上面的灯环会闪烁。接收器上的调节旋钮用于调节灵敏度大小（顺时针到底灵敏度最大）。

**▲注意：**在网络中寻线时，因为网络交换机原因（发射器发射信号，通过交换机内部电路传输到其它网线端口），与目标网线临近的几根网线可能都有音频信号，此时，可以尝试逆时针旋转接收器灵敏度旋钮，降低接收灵敏度的方法来查找目标网线。

**注意：**主机和接收器的模式需要一致，否则接收不到信号。

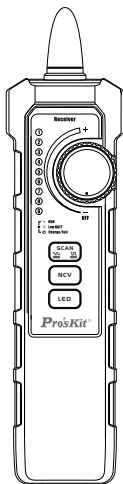

顺时针旋转接收器旋钮，打开接收器。短按“**NCV**”键开启NCV模式，当探测到大于阈值电压时，接收器喇叭发出“滴滴声”，并且探头上环灯会闪烁。

**注意：**临近的外部干扰源（如无接地的充电器等），可能会触发非接触电压的探测。

即使没有指示，电压仍然可能存在。不要仅仅依靠非接触电压探测器来判断导线是否存在电压。探测操作可能会受到插座设计、绝缘厚度及类型不同等因素的影响。

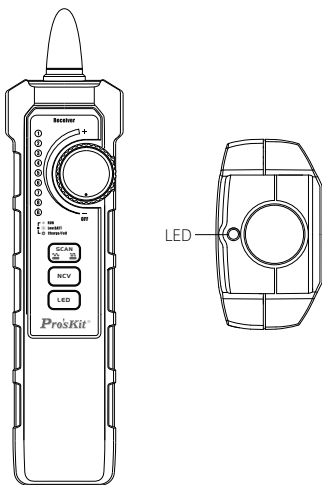

顺时针旋转接收器旋钮，打开接收器。短按 “ LED ” 键开启LED照明功能。

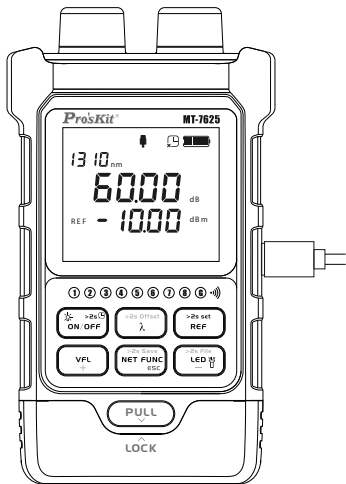

PC端通信：使用USB-C数据线将主机连接到PC端，在PC端安装上位机软件以进行数据通信相关操作，“”图标闪烁，表示正在通信中。

软件下载链接：

<https://www.prokits.com.tw/Product/MT-7625/>

## 产品规格

### 光功率计主机规格及功能

探测器类型	InGaAs
波长响应范围	700-1700nm
功率计接口	2.5mm 通用接口
测量波长	850/980/1270/1300/1310/1490/1550/1577/1625/1650nm
测量范围	-70~+10dBm
准确度*	(1550,1310nm) $\pm$ 0.2dB, (850nm,980nm,1300nm,1490nm,1625nm,1650nm) $\pm$ 0.3dB, (1270nm,1577nm) $\pm$ 1dB
分辨率	0.01dB
显示单位	dB,dBm, mW, uW, nW
频率识别	270/330/1k/2kHz (仅针对宝工光源产品)
数据存储	500 组
波长记忆	Yes
用户自校准	Yes
相对值测量	Yes
屏幕背光	Yes

### 红光功能

输出功率	15mW
测试距离**	10-12km @5M
红光源接口	2.5mm 通用接口
红光波长	650 $\pm$ 20nm
输出模式	CW/2Hz Glint

### 网络线序功能

适用网络	UTP/STP 网络线
网线接口	RJ45 (8P8C+G)
测试类型	网线顺序
测试距离	600m

### 音频寻线功能

寻线功能	模拟 & 数字模式
探测频率	455kHz
探测距离	600m



## 产品规格

### 压线功能

压接检测	RJ45 8pin: > 10cm
辅助照明	LEDx1
自动关机	可选(10分钟内无操作)
电池低电量	电池电量
充电接口	Type-C
充电时间	< 3hours
工作时间	>30 hours(功率计模式)
电池	聚合物锂电池3.7V/450mAh
使用温度	-10~50°C
环境湿度	<90%RH
尺寸	114*65*29mm
重量	120g

### 接收器功能及规格

电源开关	旋钮操作
功能选择	硅胶按键X3
响应频率	455KHz
音量	≥85dB
接收器信号	模拟/数字
喇叭音频	模拟探测(633Hz/833Hz) & 数字探测(833Hz/1500Hz)
灵敏度	旋钮调节
测试接口	RJ45× 1
线序指示灯	LED ×9
状态指示灯	LED× 3

### 非接触验电功能

非接触电压检测	AC 90V-1000V
指示灯	LED ×1 (环形)
喇叭音频	1500HZ

### 手电筒功能

辅助照明	LED×1
耳机插孔	Φ3.5mm×1

## 产品规格

充电接口	Type-C
电池	聚合物锂电池 3.7V 450mAh
工作电流	≤250mA
尺寸	180*45*26mm
重量	100g
配件	Type-C充电线x1、耳机x1、RJ45跳线x1、RJ45鳄鱼夹跳线x1、牛津布包、说明书

\*测试条件: 23°C±2°C, 40%-60%RH,使用标准测试线。

准确度范围: +3dBm~-60dBm, 其余参考如下:

±0.8dB: +3dBm~+6dBm, -60dBm~-65dBm@1550nm

±3.0dB: +6dBm~+10dBm, -65dBm~-70dBm@1550nm

\*\* 测试距离受环境条件及视觉敏感度影响。

### 一般维护

光纤连接适配器应避免与硬物接触, 并保持清洁。存放时应通风干燥, 避免受潮。长期不使用时, 每隔3个月充一次电, 充入50%-80%的电量。

### 用户可处理的故障

故障名	故障原因	处理办法
不能开机	电池没电	给电池充电
开机后马上关机	电池电量低	给电池充电
开机后操作均无效	设备程序紊乱	重新开机
测量误差大	光口端面脏污	清洁光口

## 产品保固卡

购买日期		店章
公司名称		
联络电话		
电子邮箱		
联络地址		
产品型号	□ MT-7625	

※在正常使用情况下，自原购买日起12个月免费维修保证（不含耗材，消耗品）。

※产品保固卡需盖上店章、日期章，其保固效力始生效。

※本卡请妥善保存，如需维修服务时，请出示本卡以为证明。

※保固期满后，属调整、保养或是维修性质之服务，则酌收检修工时费用。若有零件需更换，则零件费另计。

### 产品保固说明

●保固期限内，如有下列情况者，维修中心则会酌收材料成本或修理费(由本公司维修人员判定)。

- 对产品表面的损伤，包括外壳裂缝或刮痕。
- 因误用，疏忽，不当安装或测试，未经授权打开产品修理，修改产品或者任何其它超出预期使用范围的原因所造成的损害。
- 因事故，火灾，电力变化，其它危害，或自然灾害所造成的损害。

●非服务保证内容：

- 机件本体之外之配件：如布包，USB连接线，鳄鱼夹，跳线等配件。

●超过保证期限之检修或服务，虽未更换零件，将依公司保固维修政策酌收服务费。

制造商：

宝工实业股份有限公司

销售/生产商：

上海宝工工具有限公司

上海市浦东新区康桥东路1365弄25号

电话：021-68183050 服务热线：400 1699 629

网址：www.prokits.com.tw

# *Pro'sKit*®



寶工實業股份有限公司  
PROKIT'S INDUSTRIES CO., LTD  
<https://www.prokits.com.tw>  
Email: [pk@mail.prokits.com.tw](mailto:pk@mail.prokits.com.tw)

©2023 Prokit's Industries Co., LTD. All rights reserved 2023001(C)

---