



1-Channel Digital Temperature Indicators

T3 / T4 Series

PRODUCT MANUAL

For your safety, read and follow the considerations written in the instruction manual, other manuals and Autonics website.

The specifications, dimensions, etc. are subject to change without notice for product improvement. Some models may be discontinued without notice.

Safety Considerations

- Observe all 'Safety Considerations' for safe and proper operation to avoid hazards.
- ⚠ symbol indicates caution due to special circumstances in which hazards may occur.

⚠ Warning Failure to follow instructions may result in serious injury or death

- 01. Fail-safe device must be installed when using the unit with machinery that may cause serious injury or substantial economic loss. (e.g. nuclear power control, medical equipment, ships, vehicles, railways, aircraft, combustion apparatus, safety equipment, crime/disaster prevention devices, etc.)**
Failure to follow this instruction may result in personal injury, economic loss or fire.
- 02. Do not use or store the unit in the place where flammable/explosive/corrosive gas, high humidity, direct sunlight, radiant heat, vibration, impact or salinity may be present.**
Failure to follow this instruction may result in explosion or fire.
- 03. Install on a device panel to use.**
Failure to follow this instruction may result in electric shock.
- 04. Do not connect, repair, or inspect the unit while connected to a power source.**
Failure to follow this instruction may result in fire or electric shock.
- 05. Check 'Connections' before wiring.**
Failure to follow this instruction may result in fire.
- 06. Do not disassemble or modify the unit.**
Failure to follow this instruction may result in fire or electric shock.

⚠ Caution Failure to follow instructions may result in injury or product damage

- 01. When connecting the power input and relay output, use AWG 20 (0.50 mm²) cable or over and tighten the terminal screw with a tightening torque of 1.0 N m.**
When connecting the sensor input and communication cable without dedicated cable, use AWG 28 to 16 cable and tighten the terminal screw with a tightening torque of 1.0 N m.
Failure to follow this instruction may result in fire or malfunction due to contact failure.
- 02. Use the unit within the rated specifications.**
Failure to follow this instruction may result in fire or product damage
- 03. Use a dry cloth to clean the unit, and do not use water or organic solvent.**
Failure to follow this instruction may result in fire or electric shock.
- 04. Keep the product away from metal chip, dust, and wire residue which flow into the unit.**
Failure to follow this instruction may result in fire or product damage.

Cautions during Use

- Follow instructions in 'Cautions during Use'. Otherwise, it may cause unexpected accidents.
- Check the polarity of the terminals before wiring the temperature sensor. For RTD temperature sensor, wire it as 3-wire type, using cables in same thickness and length. For thermocouple (TC) temperature sensor, use the designated compensation wire for extending wire.
- Keep away from high voltage lines or power lines to prevent inductive noise. In case installing power line and input signal line closely, use line filter or varistor at power line and shielded wire at input signal line. Do not use near the equipment which generates strong magnetic force or high frequency noise.
- Install a power switch or circuit breaker in the easily accessible place for supplying or disconnecting the power.

- Do not use the unit for other purpose (e.g. voltmeter, ammeter), but temperature controller.
- 12-24 VDC power supply should be insulated and limited voltage/current or Class 2, SELV power supply device.
- Make a required space around the unit for radiation of heat. For accurate temperature measurement, warm up the unit over 20 min after turning on the power.
- Install a surge absorber at each end of inductive load coil when controlling high-capacity power relay or inductive load (e.g. magnet).
- Make sure that power supply voltage reaches to the rated voltage within 2 sec after supplying power.
- Do not wire to terminals which are not used.
- This unit may be used in the following environments.
 - Indoors (in the environment condition rated in 'Specifications')
 - Altitude Max. 2,000 m
 - Pollution degree 2
 - Installation category II

Ordering Information

This is only for reference, the actual product does not support all combinations. For selecting the specified model, follow the Autonics website.

T	①	②	③	-	④	⑤	⑥	⑦	⑧	-	⑨
---	---	---	---	---	---	---	---	---	---	---	---

① Digit
3: 3 digit
4: 4 digit

② Size
N: DIN W 48 × H 24 mm
Y: DIN W 72 × H 36 mm
W: DIN W 96 × H 48 mm
S: DIN W 48 × H 48 mm (8 pin plug type)
M: DIN W 72 × H 72 mm
H: DIN W 48 × H 96 mm
L: DIN W 96 × H 96 mm

③ Option output
I: Indicator

④ Control method
N: Indicator

⑤ Power supply
X: 12-24 VDC
4: 100-240 VAC 50/60 Hz

⑥ Control output
N: Indicator

⑦ Input type and using range

PN	Input	Using range	T3NI	T4YI T4WI	T3SI	T3HI	T4MI T4LI
K2	Thermo-couple	K(CA)	0 to 200 °C	○	-	-	-
K4			0 to 400 °C	○	-	-	-
K8			0 to 800 °C	○	-	○	-
KA			0 to 999 °C	○	-	-	○
KC			0 to 1200 °C	-	○	-	-
J2	J(IC)	J(IC)	0 to 200 °C	○	-	-	-
J4			0 to 400 °C	○	-	○	○
J5			0 to 500 °C	○	○	-	-
RF	R(PR)	R(PR)	600 to 1600 °C	-	-	-	○
P0	RTD	DPT100Ω	-99.9 to 99.9 °C	○	-	-	-
P0			-99.9 to 199.9 °C	-	○	-	○
P0			-99 to 199 °C	-	-	-	○
P1			0 to 99.9 °C	○	-	○	-
P2			0 to 200 °C	○	-	-	-
P4			0 to 400 °C	○	○	○	○

⑧ Temperature unit
C: Celsius (°C)
F: Fahrenheit (°F)
• Contact us for temperature unit °F model.

⑨ Version
N: New

Product Components

- Product (+ bracket)
- Instruction manual
- [T4YI] Product, bracket × 2

Sold Separately

- 8-pin controller socket: PG-8, PS-8 (N)
- Terminal protection cover: RMA / RHA / RLA-COVER

Initial Display When Power is ON

When power is supplied, all display parts turn ON for 1 sec. After displaying model type, it returns to RUN mode.

1. All display	2. Digit, alarm/ option output	3. Control output, input and temperature range	4. RUN mode
8.8.8.8	ε 3 n 1	n P 4 C	2 0 0

Errors

Display	Description	Troubleshooting
o P E n	Flashes when input sensor is disconnected or sensor is not connected.	Check input sensor status.
H H H H	Flashes when PV is higher than input range.	When input is within the rated input range, this display disappears.
L L L L	Flashes when PV is lower than input range.	

Specifications

Series	T3, T4 Series
Power supply	100 - 240 VAC ~ 50/60 Hz (T3NI: 12 -24 VDC ==)
Permissible voltage range	90 to 110 % of rated voltage
Power consumption	≤ 5 VA (T3NI: ≤ 1 W)
Input specification	Refer to 'Ordering Information: Input type and using range'.
Display accuracy ⁰¹⁾	<ul style="list-style-type: none"> At room temperature (23 °C ± 5 °C): (PV ± 0.5% or ± 1 °C higher one) ± 1 digit Out of room temperature range: (PV ± 0.5% or ± 2 °C higher one) ± 1 digit
Display type	7 Segment (red), LED type
Dielectric strength	Between the charging part and the case: 2,000 VAC ~ 50/60 Hz for 1 min
Vibration	0.75 mm amplitude at frequency of 10 to 55 Hz in each X, Y, Z direction for 2 hours
Insulation resistance	≥ 100 MΩ (500 VDC = megger)
Noise immunity	± 2 kV square shaped noise (pulse width 1 μs) by noise simulator R-phase, S-phase
Ambient temperature	-10 to 50 °C, storage: -20 to 60 °C (no freezing or condensation)
Ambient humidity	35 to 85%RH, storage: 35 to 85%RH (no freezing or condensation)
Certification	ERC
Unit weight (packaged)	<ul style="list-style-type: none"> T3NI: ≈ 25 g (≈ 48 g) T4YI: ≈ 123 g (≈ 181 g) T4WI: ≈ 140 g (≈ 231 g) T3SI: ≈ 80 g (≈ 120 g) T3HI: ≈ 137 g (≈ 203 g) T4MI: ≈ 137 g (≈ 202 g) T4LI: ≈ 185 g (≈ 274 g)

01) In case of T3NI, T3SI Series and the decimal point display models
At room temperature (23 °C ± 5 °C): (PV ± 0.5% or ± 2 °C higher one) ± 1 digit
Out of room temperature range: (PV ± 0.5% or ± 3 °C higher one) ± 1 digit

Dimensions

- Unit: mm, For the detailed drawings, follow the Autonics website.
- Below is based on T3SI Series.

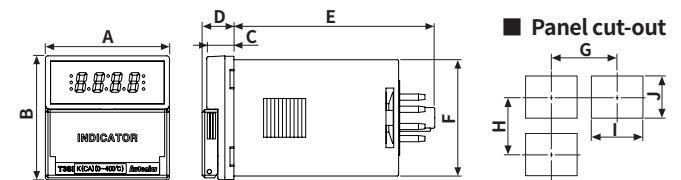

	Body						Panel cut-out			
	A	B	C	D	E	F	G	H	I	J
T3NI	48	24	4	-	48	21	≥ 55	≥ 37	45 ^{+0.5} ₀	22.2 ^{+0.3} ₀
T4YI	72	36	7	-	93	30	≥ 91	≥ 40	68 ^{+0.7} ₀	31.5 ^{+0.6} ₀
T4WI	96	48	12	-	100	45	≥ 116	≥ 52	92 ^{+0.8} ₀	45 ^{+0.6} ₀
T3SI	48	48	10.5	12.3	77.8	□45	≥ 65	≥ 65	45 ^{+0.5} ₀	45 ^{+0.5} ₀
T3HI	48	96	13	-	70	91.5	≥ 65	≥ 115	45 ^{+0.6} ₀	92 ^{+0.8} ₀
T4MI	72	72	11.8	14.3	75	□67.5	≥ 90	≥ 90	68 ^{+0.7} ₀	68 ^{+0.7} ₀
T4LI	96	96	12.5	-	70	□91.5	≥ 115	≥ 115	92 ^{+0.8} ₀	92 ^{+0.8} ₀

Bracket

T3NI

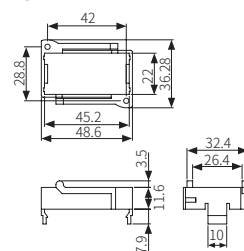

T4YI

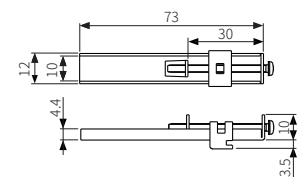

T4WI

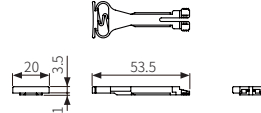

T3SI

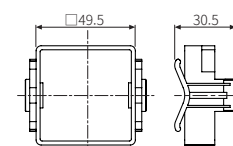

T3HI/T4MI/T4LI

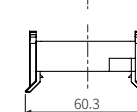
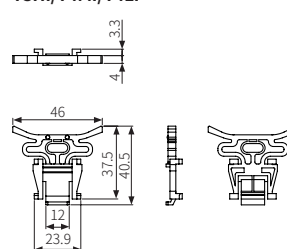

Connections

T3NI

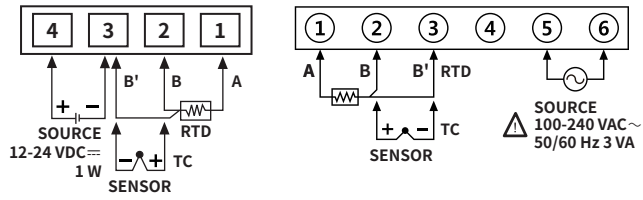

T4YI

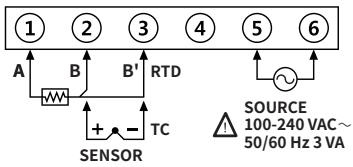

T4WI

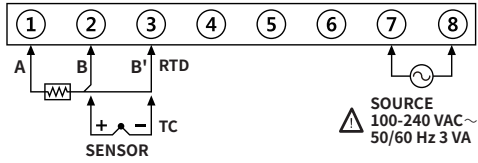

T3SI

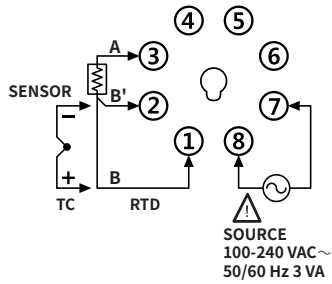

T4MI

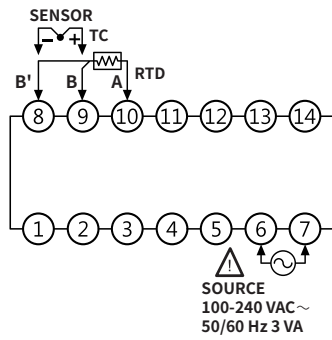

T3HI, T4LI

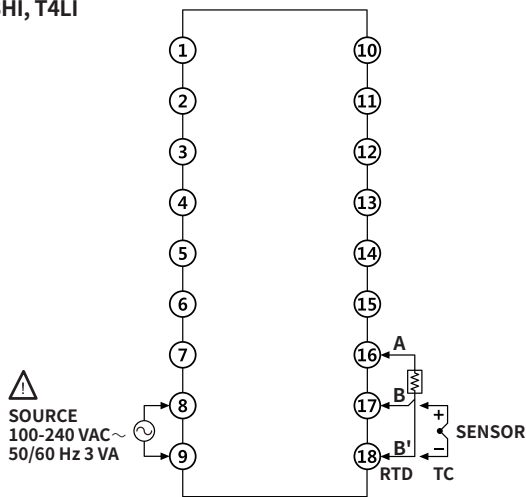

Crimp Terminal Specifications

• Unit: mm, Use the crimp terminal of follow shape.

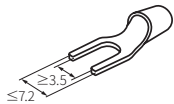

Fork crimp terminal

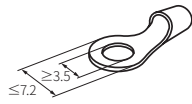

Round crimp terminal

Sold Separately: 8-pin Controller Socket

• For detailed information, refer to the 'PG Series, PS Series' manual.

Appearance	Pins	Rated Voltage	Rated current	Feature	Model
	8-pin	250 VAC~	7 A (resistance load)	Controller socket	PG-08
	8-pin	250 VAC~	7 A (resistance load)	Controller socket (DIN Rail / Panel)	PS-08(N)

Sold Separately: Terminal Protection Cover

• Unit: mm

RMA-COVER: DIN W72 × H72

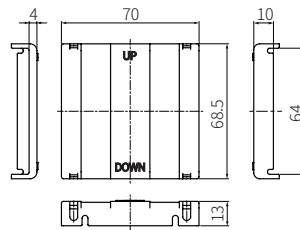

RHA-COVER: DIN W48 × H96

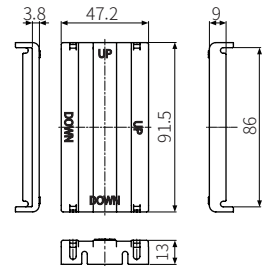

RLA-COVER: DIN W96 × H96

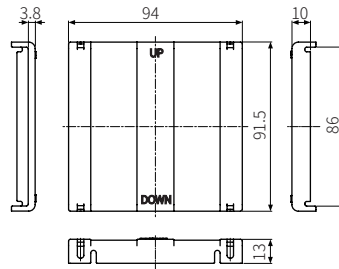

Segment Table

The segments displayed on the product indicate the following meanings. It may differ depending on the product.

7 Segment	11 Segment	12 Segment	16 Segment
0 0 i i	0 0 i i	0 0 i i	0 0 i i
1 1 j j	1 1 j j	1 1 j j	1 1 j j
2 2 k k	2 2 k k	2 2 k k	2 2 k k
3 3 l l	3 3 l l	3 3 l l	3 3 l l
4 4 m m	4 4 m m	4 4 m m	4 4 m m
5 5 n n	5 5 n n	5 5 n n	5 5 n n
6 6 o o	6 6 o o	6 6 o o	6 6 o o
7 7 p p	7 7 p p	7 7 p p	7 7 p p
8 8 q q	8 8 q q	8 8 q q	8 8 q q
9 9 r r	9 9 r r	9 9 r r	9 9 r r
A A s s	A A s s	A A s s	A A s s
b B t t	b B t t	b B t t	b B t t
c C u u	c C u u	c C u u	c C u u
d D v v	d D v v	d D v v	d D v v
E E w w	E E w w	E E w w	E E w w
F F x x	F F x x	F F x x	F F x x
G G y y	G G y y	G G y y	G G y y
H H z z	H H z z	H H z z	H H z z