





## VARISTORS JVR

JVR ZINC OXIDE VARISTOR : Varistor Voltage from 18 to 1100 V.	
Diameter	Varistor Voltage
	18                      82                                      470    1100
5φ	
7φ	
10φ	
14φ	
20φ	

\*Varistor Voltage: Voltage at 1 mA except 5φ series (at 0.1 mA)

\*BOTH VARISTORS & SILVERED DISCS ARE AVAILABLE FOR SALE.

### JVR ZINC OXIDE VARISTORS

Zinc oxide varistor is a voltage dependent resistor with symmetrical voltage-current characteristics that is designed to protect all kinds of electronic devices or elements from switching and induced lightning surges. Its non linear exponent characteristic with broad using range and mass production is gradually being used by various level of electric engineering.

#### FEATURES

- \* Fast response time.
- \* Low leakage current.
- \* Excellent voltage ratio.
- \* Wide voltage & energy ratio.
- \* Low standby power and no follow on current.
- \* High performance in surge current handling capability.
- \* High performance in clamping voltage characteristics.

### JVR氧化鋅壓敏電阻

氧化鋅壓敏電阻又稱「突波吸收器」，係一種具有電壓電流對稱特性之電壓屬性電阻器。它主要的設計是用來保護所有的電子產品或元件免於受開關或雷擊誘發所產生之突波的影響，而其非線性指數的特性與廣泛的應用範圍以及可以量產等優點，已逐漸地被應用在各種不同領域的電子工程方面。

#### 特性介紹

- \* 反應時間快速。
- \* 低漏電流。
- \* 優越之電壓比。
- \* 寬廣之電壓&能量比。
- \* 低備用電力且無後續電流。
- \* 高效能之突波電流處理能力。
- \* 抑制電壓特性之穩定執行能力。

# VARISTORS JVR

## V-I Characteristics of varistor 壓敏電阻之V-I特性

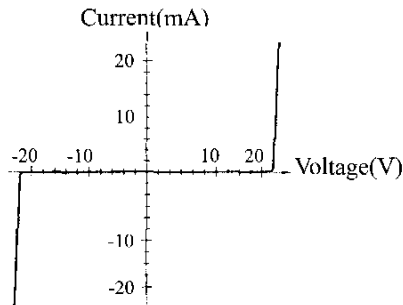

## APPLICATIONS

- \* IC, diode, transistor, thyristor, triac, and other semiconductor protection.
- \* Suppression of mainborne transients in consumer electronics and industrial electronics.
- \* Suppression of internally generated spikes in electronics circuit.
- \* Surge protection in communication, measuring and controller electronics.
- \* Surge protection in electronic home appliances and gas and petroleum appliances.
- \* Relay and electromagnetic valve surge absorption.

The varistor's rest state has a high impedance (several megaohms) in relation to the component to be protected and does not change the characteristics of the electric circuit. In the presence of transient voltage ( over the breakdown voltage of varistor), the varistor then has a low impedance (a few ohms) and short circuits, i.e. the assembly E to be protected.

## 應用範圍

- \* 保護IC, 二極體, 電晶體, 開流體, 屏蔽半導體及其他半導體等電子元件。
- \* 抑制消費性電子及工業用電子產品內部主電源所產生的瞬間突波。
- \* 抑制電子線路上內發性的突波。
- \* 通信、量測及電控等電子器材之突波保護。
- \* 房舍所裝置的以及瓦斯和油類設施上所裝置的電子器材之突波保護。
- \* 繼電器和電磁閥之突波吸收。

壓敏電阻在休息狀態時, 相對於受保護的電子元件而言, 具有很高的阻抗(數兆歐姆)而且不會改變原設計之電路特性。但當瞬間突波電壓出現(超過壓敏電阻之崩潰電壓時), 該壓敏電阻之阻抗會變低(僅有幾個歐姆而已)並造成原線路短路; 換言之; 電子產品或元件E因此而受到保護(如下圖)。

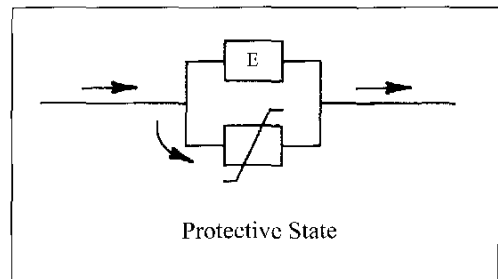
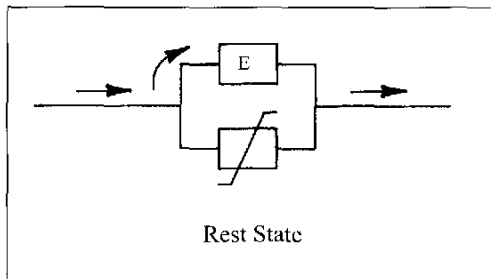

# VARISTORS JVR

## Surge suppression of varistor 壓敏電阻之突波抑制功能

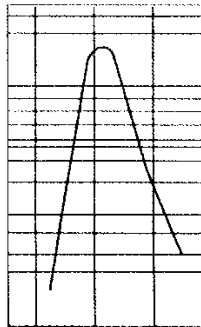

Time 時間

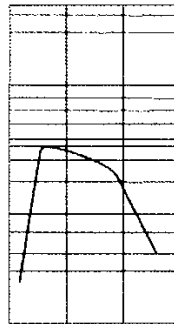

Time 時間

- ← Max. withstanding voltage of protected device  
受保護電子產品之最高耐電壓
- ← Max. clamping voltage of varistor  
壓敏電阻之最高抑制電壓
- ← The real clamping voltage occurred  
真正產生之抑制電壓
- ← Varistor voltage  
壓敏電壓(崩潰電壓)
- ← Operating voltage of protected device  
受保護電子產品之工作電壓

## PARAMETERS DEFINITION

### \*Varistor Voltage (breakdown voltage):

The varistor voltage is the voltage across the varistor measured at a specified current  $I_c$  (0.1mA or 1mA) of specified duration.

### \*Maximum allowable voltage:

The Maximum allowable voltage corresponds to the rest state of the varistor. The rest state voltage offers a low leakage current in order to limit the power consumption of the protected device and not to disturb the circuit to be protected.

### \*Non linear exponent ( $\alpha$ ):

The varistor voltage-current characteristic is defined by the equation:  $I = KV^\alpha$  where  $K$  is a constant dependent on geometry, and  $\alpha$  is the non linear exponent. We usually take two points ( $V_1, I_1$ ), ( $V_2, I_2$ ) to estimate the value of  $\alpha$ .

$$\alpha = \frac{\log I_1/I_2}{\log V_1/V_2}$$

In which  $I_1$  and  $I_2$  are the current value corresponding to the voltage value  $V_1$  and  $V_2$ .

### \*Maximum clamping voltage:

Maximum clamping voltage is the maximum voltage  $V_p$  between two terminals with the specified standard impulse current  $I$  ( $8 \times 20 \mu \text{ sec}$ ). The voltage value is an indication on the protective function of the varistor.

## CURRENT-VOLTAGE CHARACTERISTICS

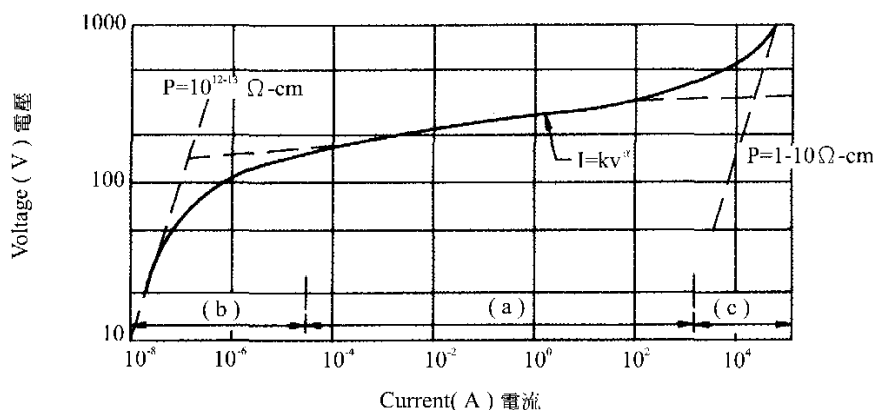

- (a) Varistor action region  
壓敏電阻工作區
- (b) Prebreakdown region  
預先崩潰區
- (c) Upturn region  
電壓上揚區

## 參數名詞解釋

### \*壓敏電壓(即崩潰電壓):

壓敏電壓係以一定的電流 $I_c$ (0.1mA或1mA)於一定的時間內通過壓敏電阻所量取之電壓。

### \*最高工作電壓:

最高工作電壓表示壓敏電阻在該電壓之下仍為休息狀態。休息狀態之壓敏電阻僅有很小的漏電流,以限制受保護電子產品之電力消耗,同時不致干擾到受保護的線路。

### \*非線性指數(即 $\alpha$ 值):

壓敏電阻之電壓-電流(V-I)特性係由公式 $I = KV^\alpha$ 所定義的,  $K$ 是一幾何常數,而 $\alpha$ 則是非線性指數。吾人通常截取二點( $V_1, I_1$ )及( $V_2, I_2$ )來計算其 $\alpha$ 值,

$$\alpha = \frac{\log I_1/I_2}{\log V_1/V_2}$$

$I_1$ 及 $I_2$ 係電壓等於 $V_1$ 及 $V_2$ 時相對應之電流值。

### \*最高抑制電壓:

最高抑制電壓係以一定之標準衝擊電流 $I_p$ ( $8 \times 20 \mu \text{ sec}$ )於壓敏電阻二條引線端點之間所量得之最高電壓 $V_p$ 。該電壓值同時也是壓敏電阻發揮其保護功能的一項指標。

## 電流電壓特性曲線

## VARISTORS JVR

### \*Withstanding surge current:

Withstanding surge current is the maximum peak current for the varistor with the specified standard impulse current ( $8 \times 20 \mu \text{ sec}$ ) applied one time or two times and corresponding to a permissible variation of 10% in the varistor voltage change.

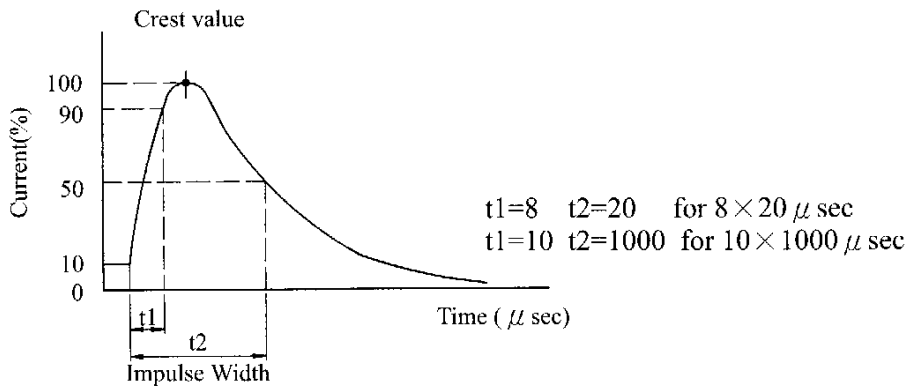

### \*Energy

Maximum energy from one or a burst of pulses. It is the value within the varistor change of + 10% when one impulse of  $10 \times 1000 \mu \text{ sec}$  is applied.

$$E = K \times V_m \times I_m \times T$$

E: Energy

K: Constant=1.4

$V_m$ : Max. clamping voltage at  $I_m$ .

$I_m$ : Max. allowable single surge current of  $10 \times 1000 \mu \text{ sec}$ .

T: Duration of surge current ( $1000 \mu \text{ sec}$ )

### \*Rated power

The maximum power that can be applied within the specified ambient temperature.

### \*Capacitance

The capacitance of varistor is the reference value measured between the varistor terminals at specified frequency.

### \*Pulse lifetime rating

This is expressed as the maximum allowable number of impulse currents applied.  $8 \times 20 \mu \text{ sec}$  impulse current ( or  $10 \times 1000 \mu \text{ sec}$ ) is applied at prescribed interval. This curve also provides for derating current as required with repetitive pulsing.

### \*耐突波電流(即突波耐量):

突波耐量乃壓敏電阻以一定之標準衝擊電流( $8 \times 20 \mu \text{ sec}$ )衝擊1次或2次時,壓敏電阻之變化在10%以內的最大脈衝電流。

### \*能量(即焦耳值):

表示一次脈衝之最大能量,亦即以 $10 \times 1000 \mu \text{ sec}$ 衝擊一次而壓敏電阻之變化仍在10%以內之焦耳值。其公式:

$$E = K \times V_m \times I_m \times T$$

E : 能量(焦耳)

K : 常數,約等於1.4。

$V_m$  : 電流在 $I_m$ 時之最高抑制電壓。

$I_m$  : 最大允許之 $10 \times 1000 \mu \text{ sec}$ 單一次突波電流。

T : 突波電流延續時間( $1000 \mu \text{ sec}$ )

### \*額定功率(即瓦特數):

表示在一定的環境溫度下所能消耗的最大功率。

### \*電容值:

壓敏電阻之電容值係以一定的頻率於引線端點之間所量得的參考值。

### \*額定脈衝壽命:

表示壓敏電阻以 $8 \times 20 \mu \text{ sec}$ . (或 $10 \times 1000 \mu \text{ sec}$ .) 的衝擊電流,依規定的間隔時間連續給予衝擊時所能承受之最高衝擊次數。其受衝擊時所呈現的曲線同時也提供了連續衝擊每次所需求的遞減電流。

# VARISTORS JVR

## SOURCE OF SURGE VOLTAGE

- \* Direct lightning surges.
- \* Surge voltage by grounding fault.
- \* From magnetic induction.
- \* Induced lightning surges.
- \* Surge voltage by switching operation.
- \* From electrostatic induction.

## 突波電壓之來源

- \* 直接雷擊所產生的突波。
- \* 接地不良所產生的突波。
- \* 各種磁性所誘發的突波。
- \* 因雷擊間接誘發的突波。
- \* 開關電源所產生的突波。
- \* 靜電特性所誘發的突波。

## HOW TO SELECT JVR VARISTOR

- \* To identify the source and route of surge.
- \* To decide the connection method of varistor.
- \* To decide varistor voltage and max. clamping voltage.
- \* To decide surge current waveform by calculation from surge voltage and surge impedance.
- \* To check whether the withstanding surge current and surge life of varistor is sufficient or not.
- \* To check the variation of electric power of protected device.
- \* To check whether the max. energy and energy life of varistor is enough or not.
- \* To check the relation:  
Max. withstanding voltage of protected device > Max. clamping voltage of varistor > The real clamping voltage occurred > Breakdown voltage of varistor > Operating voltage of protected device.
- \* To check whether the loss of capacitance of varistor in operating condition.
- \* To check whether the problem caused by loss current of leakage.
- \* To check the connection method of varistor.
- \* To check the condition of varistor overload.
- \* To check any other problems by various operating conditions.
- \* To test and to verify by real practice.
- \* To check the connection of the grounding wire.

## 如何選用JVR壓敏電阻

- \* 確定突波的來源及其通路。
- \* 確定壓敏電阻的連接方式。
- \* 確定所需要的壓敏電壓及最高抑制電壓。
- \* 依突波電壓和突波阻抗計算出突波電流的波形。
- \* 檢查壓敏電阻的突波耐量和脈衝壽命是否足夠。
- \* 檢查受保護電子產品所使用電源的變動(穩定)程度。
- \* 檢查壓敏電阻的最大能量和能量壽命是否足夠。
- \* 檢查下列關係是否正確:  
受保護電子產品之最高耐電壓 > 壓敏電阻之最高抑制電壓 > 真正產生之抑制電壓 > 壓敏電阻之崩潰電壓 > 受保護電子產品之工作電壓
- \* 檢查壓敏電阻於工作狀態下是否損失其電容值。
- \* 若出現問題先檢查是否漏電流太大之原因。
- \* 檢查壓敏電阻連接方式是否適當。
- \* 檢查壓敏電阻負荷是否過人。
- \* 檢查壓敏電阻於工作狀態下是否有其他任何問題。
- \* 受保護電子產品以實際操作來測試及確認所使用之壓敏電阻。
- \* 檢查接地線之連接狀況。

## PART NUMBER CODE JVR

## JVR產品料號代碼

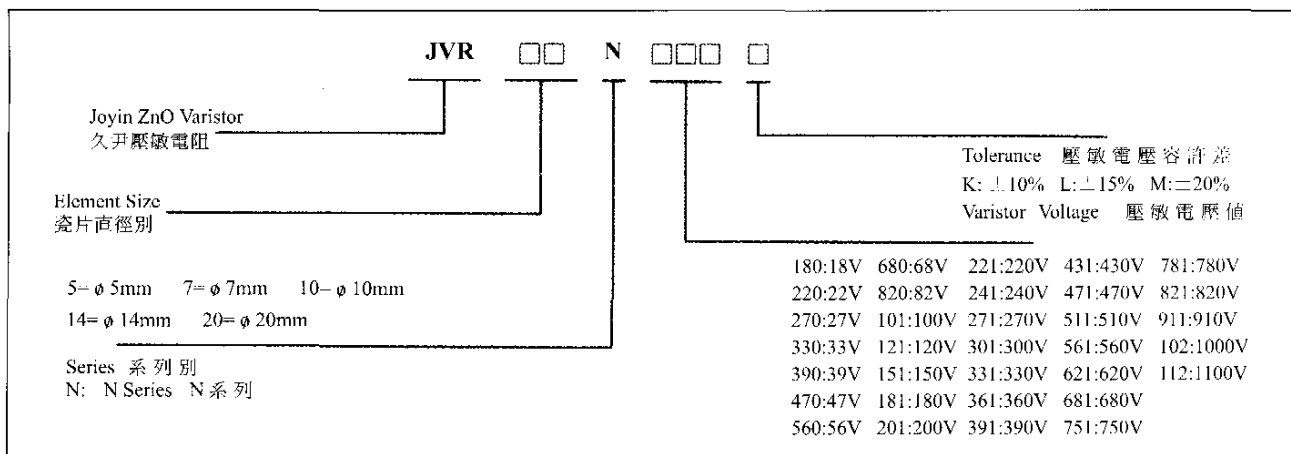

**MECHANICAL & ENVIRONMENTAL TESTING****\* Terminal Pull Strength(IEC 1051-1 4.10.2)**

After gradually applying the load specified below and keeping the unit fixed for  $10 \pm 1$  seconds. The change of  $V_b$  shall be measured and meet the requirement of  $\Delta V_b/V_b$  less than  $\pm 10\%$  with no outstanding damage.

Terminal diameter	Loading weight in pull strength
0.6 mm (0.024")	10N(1.02Kg)
0.8 mm (0.031")	10N (1.02Kg)
1.0 mm (0.039")	20N (2.04Kg)

**Loading weight in bending strength**

5N (0.51 Kg)

5N(0.51Kg)

10N(1.02 Kg)

**\* Terminal Bending Strength (IEC 1051-1 4.10.3)**

The unit shall be secured with its terminal kept vertical and the weight specified above be applied in the axial direction. The terminal shall gradually be bent by  $90^\circ$  in one direction, then  $90^\circ$  in the opposite direction, and again back to the original position. The change of  $V_b$  shall be measured and meet the requirement of  $\Delta V_b/V_b$  less than  $\pm 10\%$  with no outstanding damage.

**\* Vibration (IEC 1051-1 4.16)**

Subjected to simple harmonic motion of 0.75mm amplitude 1.5mm maximum total excursion between limits of 10~55Hz. Frequency scan shall be traversed in one minute. This motion shall then be applied for period of two hours in each of three mutually perpendicular directions. The change of  $V_b$  shall be measured and meet the requirement of  $\Delta V_b/V_b$  less than  $\pm 10\%$  with no outstanding damage.

**\* Solderability (IEC 1051-1 4.11)**

After dipping the terminal to a depth of approximately 1.5~2mm from the body in a soldering bath of  $235 \pm 5^\circ\text{C}$  for  $2 \pm 0.5$  seconds, the terminations shall be uniformly tinned.

**\* Resistance to Soldering Heat(IEC 1051-1 4.12)**

The terminal shall be dipped into a soldering bath with temperature of  $260 \pm 5^\circ\text{C}$  to a point of 1.5~2mm from the body of the unit and then be held there for 5 or  $10 \pm 1$  sec. The change of  $V_b$  shall be measured and meet the requirement of  $\Delta V_b/V_b$  less than  $\pm 10\%$  with no outstanding damage.

**\* Damp heat, steady state (IEC 1051-1 4.18)**

The specimen shall be subjected to  $40^\circ\text{C}$ , 90 to 95% R.H. for 56 days. One half specimen shall be subjected to this test without voltage applied. The other 50% shall be tested with 10% of the max. D.C. voltage applied and then stored at room temperature and humidity for one to two hours. The change of  $V_b$  shall be measured and meet the requirement of  $\Delta V_b/V_b$  less than  $\pm 10\%$  with no outstanding damage.

**機械測試及環境測試項目****\* 端子拉力強度測試 (IEC 1051-1 4.10.2)**

以漸進的方式逐漸增加壓敏電阻二條引線端點之負荷，直至下表所指定的重量為止，然後使其穩定地維持1秒鐘即可。測試其電壓( $V_b$ )的變化 $\Delta V_b/V_b$ 必須小於 $\pm 10\%$ ，同時目視檢查有無顯著的傷害。

引線直徑	引線直接下拉重量
0.6mm (0.024")	10N(1.02Kg)
0.8mm (0.031")	10N (1.02Kg)
1.0mm (0.039")	20N (2.04Kg)

**引線彎曲橫拉重量**

5N (0.51 Kg)

5N (0.51 Kg)

10N(1.02 Kg)

**\* 端子彎曲強度測試 (IEC 1051-1 4.10.3)**

當前項拉力試驗完成後，引線須保持 $90^\circ$ 垂直狀態，二條引線則成一軸線方向。然後將其中一條引線逐漸朝原方向彎折 $90^\circ$ ，之後朝反方向彎折 $90^\circ$ ，最後再朝原方向彎折 $90^\circ$ 回到原位，測試其電壓( $V_b$ )的變化， $\Delta V_b/V_b$ 必須小於 $\pm 10\%$ ，同時目視檢查有無顯著的傷害。

**\* 振動測試 (IEC 1051-1 4.16)**

振動機之設定條件為：簡單的諧振運動，振幅0.75mm，頻率10~55Hz，其總位移幅度最大為1.5mm，1分鐘之內應做頻率掃描確認。依此條件之振動試驗，必須就三個軸向各做2個小時，測試其電壓( $V_b$ )的變化， $\Delta V_b/V_b$ 必須小於 $\pm 10\%$ ，同時目視檢查有無顯著的傷害。

**\* 焊錫性測試 (IEC 1051-1 4.11)**

將引線浸入錫槽，深度為距產品本體底部約1.5~2mm，錫溫 $235 \pm 5^\circ\text{C}$ 浸 $2 \pm 0.5$ 秒鐘後，以目視檢查沾錫的均勻度。

**\* 焊錫耐熱性測試 (IEC 1051-1 4.12)**

同焊錫性試驗方法將引線浸 $260 \pm 5^\circ\text{C}$ 之錫槽內5或 $10 \pm 1$ 秒鐘後，測試其電壓( $V_b$ )的變化， $\Delta V_b/V_b$ 必須小於 $\pm 10\%$ ，同時目視檢查有無顯著的傷害。

**\* 濕熱穩態測試 (IEC 1051-1 4.18)**

樣品在 $40^\circ\text{C}$ ，相對濕度90%-95%一半置於無負載環境，另一半置於10%直流最大工作電壓的環境下儲放56天後，取出置於室溫和正常濕度下2小時，測試其電壓( $V_b$ )的變化。 $\Delta V_b/V_b$ 必須小於 $\pm 10\%$ ，同時目視檢查有無顯著的傷害。

## VARISTORS JVR

### \*Rapid change of temperature (IEC 1051-1 4.13)

The temperature cycle is repeated five times with (1)  $-40 \pm 3^{\circ}\text{C}$  keeping 30 minutes then (2)  $85 \pm 2^{\circ}\text{C}$  keeping 30 minutes and then stored at room temperature and humidity for one to two hours. change of  $V_b$  shall be measured and meet the requirement of  $\Delta V_b/V_b$  less than  $\pm 10\%$  with no outstanding damage.

### \* Endurance at upper category temperature (IEC 1051-1 4.20)

The maximum continuous D.C. or A.C. voltage, and taking account of the V-T derating curve, shall be applied in cycles of 1.5h on and 0.5h off throughout the test in accordance with the appropriate operating conditions at  $85 \pm 2^{\circ}\text{C}$  for  $1000 \pm 24$  hours. The specimen shall be stored at room temperature and humidity for one to two hours. The change of  $V_b$  shall meet the requirement of  $\Delta V_b/V_b$  less than  $\pm 10\%$  with no outstanding damage.

### \* Pulse current (IEC 1051-1 4.5)

At room temperature with listed pulse Lifetime curve applied, the following two tests are conducted (1) 10 pulses  $8 \times 20 \mu\text{s}$  at 2 per min. in one direction (2) 10 pulses  $10 \times 1000 \mu\text{s}$  in one direction, 1 every 2 min. The change of  $V_b$  shall be measured under  $\Delta V_b/V_b$  less than  $\pm 10\%$  with no outstanding damage.

### \* Climatic sequence (IEC 1051-1 4.17)

- (a) Dry heat Temperature/Duration:  $85^{\circ}\text{C}/2\text{h}$
- (b) Damp heat cyclic 1st cycle Temperature/Duration/Humidity:  $55^{\circ}\text{C}/24\text{h}/90\sim 100\% \text{ R.H.}$
- (c) Cold Temperature/Duration:  $40^{\circ}\text{C}/2\text{h}$
- (d) Damp heat cyclic test remaining Temperature/Duration/ Humidity:  $55^{\circ}\text{C}/5$  cycles of  $24\text{h}/80\sim 100\% \text{ R.H.}$

The change of  $V_b$  shall be measured under  $\Delta V_b/V_b$  less than  $\pm 10\%$  with no outstanding damage.

### \* High Temperature Load (IEC 1051-1 4.20)

After being continuously applied the maximum allowable voltage at  $85 \pm 2^{\circ}\text{C}$  for  $1000 \pm 24$  hours, the specimen shall be stored at room temperature and humidity for one to two hours. The change of  $V_b$  shall be measured  $\Delta V_b/V_b$  less than  $\pm 10\%$  with no outstanding damage.

### \* High Temperature Storage (IEC 1051-1 4.17.3)

The specimen shall be subjected to  $125 \pm 2^{\circ}\text{C}$  for 1000 hours in a drying oven without load and then stored at room temperature and humidity for one to two hours. The change of  $V_b$  shall be measured under  $\Delta V_b/V_b$  less than  $\pm 10\%$  with no outstanding damage.

## GENERAL CHARACTERISTICS

- \* Storage temperature :  $-40^{\circ}\text{C}$ ,  $+125^{\circ}\text{C}$
- \* Max. response time : 25 nsec.
- \* Max. operating temperature :  $+85^{\circ}\text{C}$
- \* Temp. coefficient of voltage :  $-0.05\%/^{\circ}\text{C}$
- \* Max. working surface temp. :  $+115^{\circ}\text{C}$
- \* Insulation resistance (at D.C. 500V) : Over 1000M $\Omega$

### \* 溫度變化測試 (IEC 1051-1 4.13)

每一週期之衝擊溫度包括(1)  $-40^{\circ}\text{C} \pm 3$  停留30分鐘(2)  $85 \pm 2^{\circ}\text{C}$  停留30分鐘, 反覆衝擊五個週期之後, 取出置於室溫和正常濕度下2小時, 測試其電壓( $V_b$ )的變化,  $\Delta V_b/V_b$ 須小於 $\pm 10\%$ , 同時目視檢查有無顯著傷害。

### \* 高溫操作測試 (IEC 1051-1 4.20)

在  $85 \pm 2^{\circ}\text{C}$  的高溫環境下, 考慮V-T減低曲線, 加以直流或交流最大工作電壓在1.5小時開, 0.5小時關的環境下工作  $1000 \pm 24$  小時, 取出置於室溫和正常濕度下2小時, 測試其電壓( $V_b$ )的變化。  $\Delta V_b/V_b$  必須小於 $\pm 10\%$ , 同時目視檢查有無顯著的傷害。

### \* 脈衝電流試驗 (IEC 1051-1 4.5)

樣品在室溫條件下, 依突波壽命曲線之脈衝電流(1)  $8 \times 20 \mu\text{s}$  脈衝電流以間隔30秒之頻率連續衝擊10次 (2)  $10 \times 1000 \mu\text{s}$  脈衝電流以間隔2分鐘之頻率連續衝擊10次, 測試其電壓( $V_b$ )的變化,  $\Delta V_b/V_b$  必須小於 $\pm 10\%$ , 同時目視檢查有無顯著的傷害。

### \* 氣候系列 (IEC 1051-1 4.17)

- (a) 乾熱—溫度/期間:  $85^{\circ}\text{C}/2$  小時。
- (b) 濕熱循環第一次循環—溫度/期間/濕度:  $55^{\circ}\text{C}/24$  小時/相對濕度  $90\sim 100\%$ 。
- (c) 耐寒性—溫度/期間:  $-40^{\circ}\text{C}/2$  小時。
- (d) 濕熱循環維持循環—溫度/期間/濕度:  $55^{\circ}\text{C}/24$  小時共5個循環/相對濕度  $80\sim 100\%$ , 測試其電壓( $V_b$ )的變化,  $\Delta V_b/V_b$  必須小於 $\pm 10\%$ , 同時目視檢查有無顯著的傷害。

### \* 高溫負載測試 (IEC 1051-1 4.20)

樣品持續加以最高工作電壓之負載, 於  $85 \pm 2^{\circ}\text{C}$  的環境下工作  $1000 \pm 24$  小時後, 取出置於室溫和正常濕度下2小時, 測試其電壓( $V_b$ )的變化。  $\Delta V_b/V_b$  必須小於 $\pm 10\%$ 。

### \* 高溫儲存測試 (IEC 1051-1 4.17.3)

樣品先在  $125 \pm 2^{\circ}\text{C}$  的烤箱中, 無負載的儲放1000小時, 然後取出置於室溫和正常濕度下2小時, 在測試其電壓( $V_b$ )的變化。  $\Delta V_b/V_b$  必須小於 $\pm 10\%$ , 同時目視檢查有無顯著傷害。

## JVB 壓敏電阻之一般特性

- \* 儲存溫度:  $-40^{\circ}\text{C}$ ,  $+125^{\circ}\text{C}$
- \* 最大反應時間: 25 nsec
- \* 最高工作溫度:  $+85^{\circ}\text{C}$
- \* 電壓溫度係數:  $-0.05\%/^{\circ}\text{C}$
- \* 最高表面溫度:  $+115^{\circ}\text{C}$
- \* 絕緣電阻 (D.C. 500V) : 1000M $\Omega$  以上

# VARISTORS JVR

## DIMENSION OF COMPONENT

Dimension Table	measure:mm				
Dim( $\phi$ )	5 $\phi$	7 $\phi$	10 $\phi$	14 $\phi$	20 $\phi$
D max.	7.5	9.0	12.5	16.5	23
d( $\pm 0.05$ )	0.6	0.6	*0.6/0.8	0.8	1.0
F( $^{+0.8}_{-0.2}$ )	5.0	5.0	*5.0/7.5	7.5	10.0
H max.	11.0	13	18	22	28
H <sub>1</sub> max.	3.5	3.5	5	5	5
L min.	24.0	24.0	24.0	24.0	24.0
L <sub>1</sub> min.	25.0	25.0	25.0	25.0	25.0

OPTION:

\* JVR10N180K-391K d=0.6, F=5.0 with bulk or taping package will be offered by lower price.

Table of T max, a, & P<sub>I</sub> max

Part No.	5 $\phi$			7 $\phi$			10 $\phi$			14 $\phi$			20 $\phi$		
	T max.	a 0.8	P <sub>I</sub> max.	T max.	a 0.8	P <sub>I</sub> max.	T max.	a 0.8	P <sub>I</sub> max.	T max.	a 0.8	P <sub>I</sub> max.	T max.	a 0.8	P <sub>I</sub> max.
180K	4.5	1.4	3.0	4.5	1.4	3.0	4.9	1.4	3.0	5.0	1.5	3.0	5.2	1.5	3.0
220K	4.5	1.5	3.0	4.5	1.5	3.0	4.9	1.5	3.0	5.0	1.6	3.0	5.3	1.6	3.0
270K	4.7	1.5	3.0	4.7	1.5	3.0	5.1	1.5	3.0	5.2	1.7	3.0	5.4	1.7	3.0
330K	4.7	1.6	3.0	4.7	1.6	3.0	5.1	1.6	3.0	5.2	1.8	3.0	5.4	1.8	3.0
390K	4.7	1.8	3.0	4.7	1.8	3.0	5.1	1.8	3.0	5.2	2.0	3.0	5.4	2.0	3.0
470K	5.0	1.8	3.0	5.0	1.8	3.0	5.5	1.8	3.0	5.6	2.0	3.0	5.6	2.0	3.0
560K	5.0	2.0	3.0	5.0	2.0	3.0	5.5	2.0	3.0	5.6	2.2	3.0	5.6	2.2	3.0
680K	5.5	2.3	3.0	5.5	2.3	3.0	6.0	2.3	3.0	6.1	2.5	3.0	6.1	2.5	3.0
820K	3.3	1.4	3.0	3.3	1.4	3.0	3.8	1.4	3.0	3.9	1.6	3.0	4.4	1.8	3.0
101K	3.4	1.4	3.0	3.4	1.4	3.0	3.9	1.4	3.0	4.0	1.6	3.0	4.5	1.8	3.0
121K	3.6	1.5	3.0	3.6	1.5	3.0	4.0	1.5	3.0	4.2	1.7	3.0	4.7	1.9	3.0
151K	4.1	1.8	3.0	4.1	1.8	3.0	4.5	1.8	3.0	4.7	2.0	3.0	5.2	2.2	3.0
181K	4.1	1.6	3.0	4.1	1.6	3.0	4.5	1.6	3.0	4.7	1.8	3.0	5.2	2.0	3.0
201K	4.2	1.6	3.0	4.2	1.6	3.0	4.6	1.6	3.0	4.8	1.8	3.0	5.3	2.0	3.0
221K	4.3	1.7	3.0	4.3	1.7	3.0	4.7	1.7	3.0	4.9	1.9	3.0	5.4	2.1	3.0
241K	4.4	1.7	3.0	4.4	1.9	3.0	4.8	1.9	3.0	5.0	2.1	3.0	5.5	2.3	3.0
271K	4.6	1.9	3.0	4.6	2.0	3.0	5.0	2.0	3.0	5.2	2.1	3.0	5.7	2.5	3.0
301K	4.8	1.9	3.0	4.8	2.1	3.0	5.2	2.2	3.0	5.4	2.3	3.0	5.9	2.7	3.0
331K	4.9	1.9	3.0	4.9	2.1	3.0	5.3	2.2	3.0	5.5	2.3	3.0	6.0	2.7	3.0
361K	5.1	2.4	3.0	5.1	2.5	3.0	5.5	2.5	3.0	5.7	2.7	3.0	6.2	2.9	3.0
391K	5.3	2.6	3.5	5.3	2.6	3.5	5.7	2.8	3.5	5.9	2.8	3.5	6.4	3.0	3.5
431K	5.5	2.7	3.5	5.5	2.9	3.5	5.9	3.1	3.5	6.1	3.1	3.5	6.6	3.3	3.5
471K	5.8	2.8	3.5	5.8	2.9	3.5	6.2	3.2	3.5	6.4	3.3	3.5	6.9	3.5	4.0
511K							6.4	3.7	4.0	6.6	3.7	4.0	7.1	3.9	4.0
561K							6.7	4.0	4.0	6.9	4.0	4.0	7.4	4.2	4.0
621K							7.0	4.6	4.0	7.2	4.4	4.0	7.7	4.7	4.0
681K							7.4	5.0	4.0	7.6	4.7	4.0	8.1	5.0	4.0
751K							7.8	5.0	4.0	8.0	4.9	4.0	8.5	5.1	4.0
781K							8.0	5.2	4.0	8.2	5.2	4.0	8.7	5.4	4.0
821K							8.2	5.2	4.0	8.4	5.2	4.0	8.9	5.4	4.0
911K							8.8	6.0	4.0	9.0	6.0	4.0	9.5	6.3	4.0
102K							9.3	6.0	4.0	9.5	6.2	4.0	10.1	6.4	4.0
112K							9.9	6.3	4.0	10.1	6.7	4.0	10.6	6.9	4.0

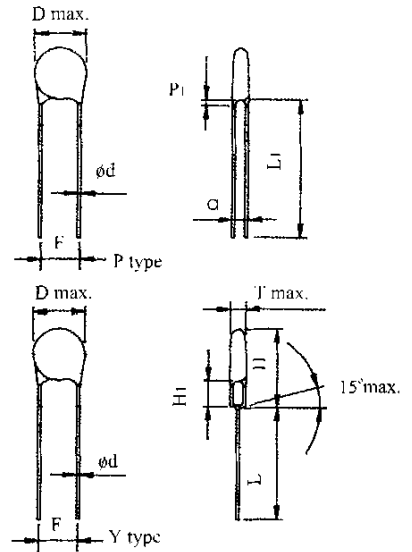



# VARISTORS JVR

## DIMENSION OF TAPING PRODUCT

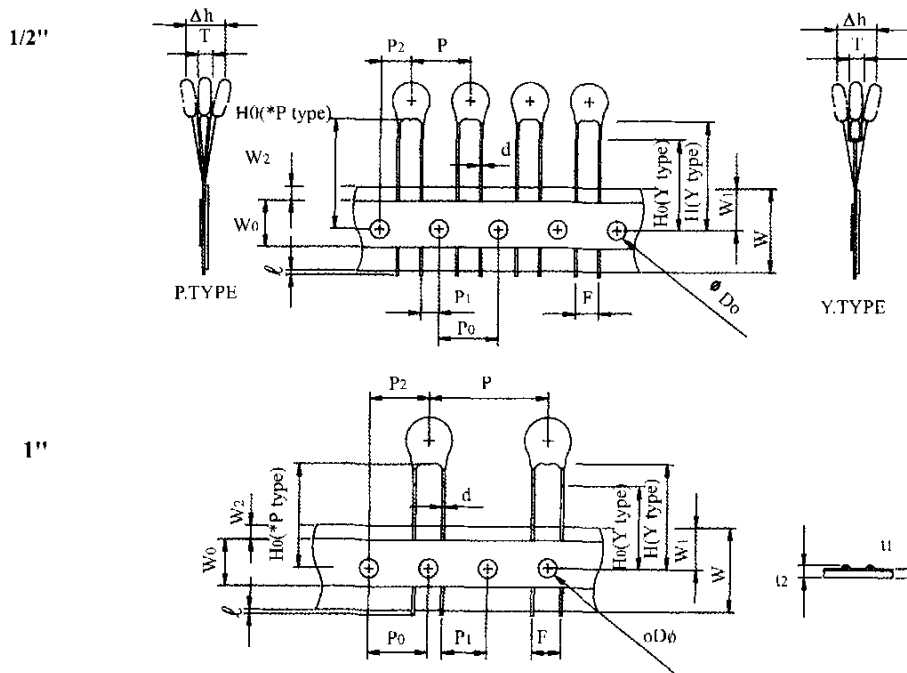

Sb	Item	5 $\phi$ 7 $\phi$ 10 $\phi$	(10 $\phi$ ) 14 $\phi$ 20 $\phi$
1	Cut out length	1.1 mm max.	1.1 mm max.
H(Y type)	Height of component from hole center	20.0 mm max.	21.5 mm max.
H0(Y type)	Height to seating plane	16.0 $\pm$ 0.5 mm $\pm$ 0.5	16.0 $\pm$ 0.5 mm $\pm$ 0.5
H0(P type)	Height of component from hole center	16.0mm~21.0mm	16.0mm~21.0mm
$\Delta h$	Front to back deviation	0 $\pm$ 2.0 mm	0 $\pm$ 2.0 mm
W	Carrier tape width	18.0 $^{+1}_{-0.5}$ mm	18.0 $^{+1}_{-0.5}$ mm
W0	Hold down tape width	10.0 mm	12.0 mm
W1	Sprocket hole position	9.0 $^{+0.75}_{-0.5}$ mm	9.0 $^{+0.75}_{-0.5}$ mm
W2	Adhesive tape position	3.0 mm max.	3.0 mm max.
F	Component lead spacing	5.0 $^{+0.8}_{-0.2}$ mm	7.5 $^{+0.8}_{-0.2}$ mm
P	Pitch of component	12.7 $\pm$ 0.3mm	25.4 $\pm$ 0.3mm max.
P0	Sprocket hole pitch	12.7 $\pm$ 0.3mm	12.7 $\pm$ 0.3mm
P1	Lead length from hole center to lead	3.85 $\pm$ 0.7mm	8.95 $\pm$ 0.7mm
P2	Length from hole center to disk center	6.35 $\pm$ 1.3mm	12.7 $\pm$ 1.3mm
D0	Sprocket hole diameter	4.0 $\pm$ 0.2mm	4.0 $\pm$ 0.2mm
d	Lead wire diameter	0.6 $\pm$ 0.05mm	0.8 $\pm$ 0.05mm
T	Disk thickness	See T max. table	See T max. table
t1	Total thickness tape	0.7 $\pm$ 0.05mm	0.7 $\pm$ 0.05mm
t2	Total thickness tape with tape	1.6 mm max.	1.8 mm max.

# VARISTORS JVR

## MARKING & PACKAGING

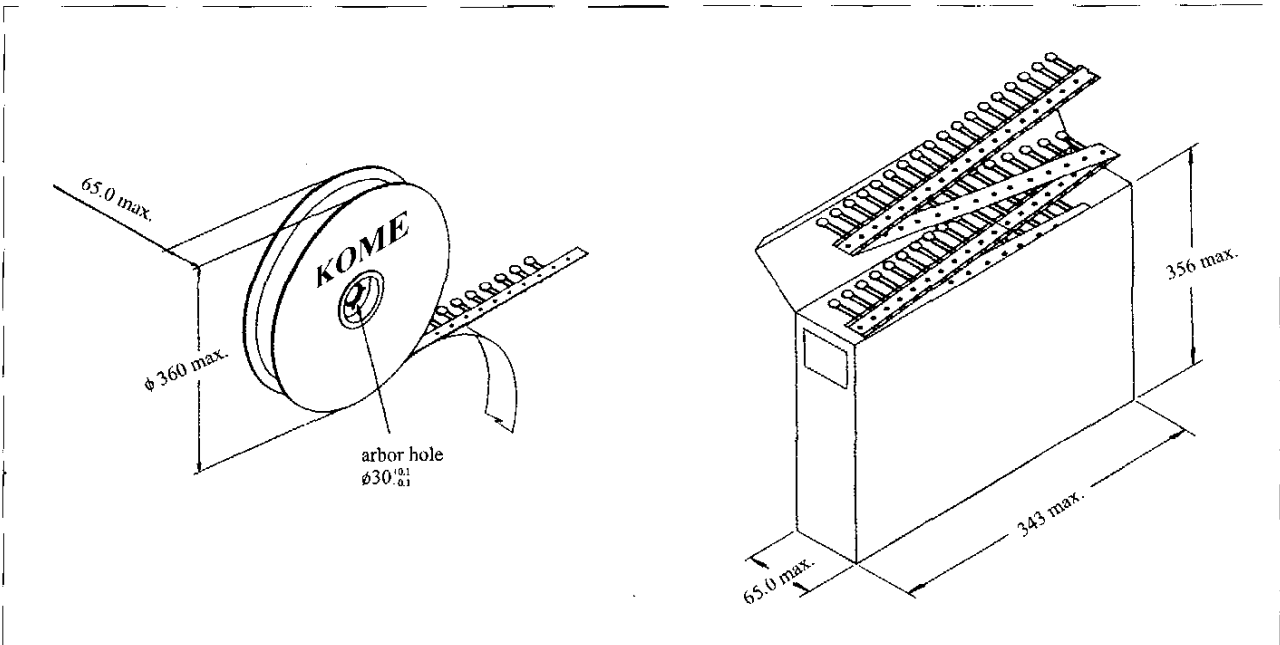
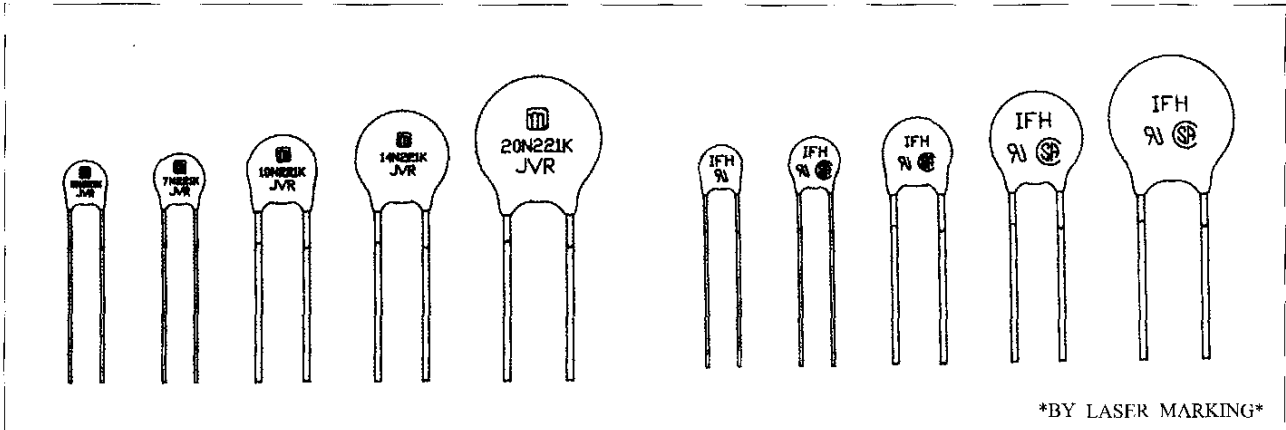

### Quantity per Package Unit

Series Part No.	5 $\phi$			7 $\phi$			10 $\phi$			14 $\phi$		
	Bulk(box)	Reel	Ammo	Bulk(box)	Reel	Ammo	Bulk(box)	Reel	Ammo	Bulk(box)	Reel	Ammo
180k ~ 391k	5000	1500	1500	5000	1500	1500	2500	1000	500/1000*	1500	750	500
431k ~ 471k	5000	1500	1000	5000	1000	1000	2000	750	500	1500	750	500
511k ~ 751k	--	--	--	--	--	--	1500	--	--	750	--	--
781k ~ 112k	--	--	--	--	--	--	1500	--	--	750	--	--

\* Packaging quantity for 10N180K ~ 10N680K, F = 5.0mm.

## VARISTORS JVR

Series Part No.	20 φ		
	Bulk(box)	Reel	Ammo
180k ~ 471k	750	--	--
511k~112k	450	--	--

Packaging	Bulk (box)	Reel	Reel(for 14φ)	Ammo	Ammo( for 14φ)
Box size(mm)	290×155×110	350×350×122	350×350×74	330×240×45	330×240×55
Carton size(mm)	300×330×240	360×360×570	360×360×470	340×490×235	360×490×270
One carton with	4 Boxes	5Boxes×2Reels	6Boxes×1Reel	10 Boxes	8 Boxes

### HOW TO ORDER BY PART NUMBER:

1 2 3 4 5 6 7 8 9 10 11 12  
 J V R □ □ N □ □ □ K □ □

Code No. : 4, 5 --- Diameter                      Code No. : 7,8,9 --- Varistor Voltage

Code No. : 11 --- Lcad Wire Style              Y = Kink Type    P = Straight Type

Code No. : 12 --- Packaging Style              R = Reel Package    A = Ammo Package

B = Bluk Package

### EXAMPLES OF APPLICATION

#### \* Varistor voltage selection in line circuit

Power supply voltage	Type
100V AC	JVR- □□N201K    JVR- □□N221K JVR- □□N241K    JVR- □□N271K
200V AC	JVR- □□N391K    JVR- □□N431K JVR- □□N471K
12V DC	JVR- □□N220K
24V DC	JVR- □□N390K

#### \* Varistor voltage selection in line to ground circuit

Power supply voltage	Type
100V AC, 200V AC	JVR- □□N431K    JVR- □□N471K JVR- □□N751K to JVR-□□N112K

#### \* Line Circuit

AC/DC single-phase circuit

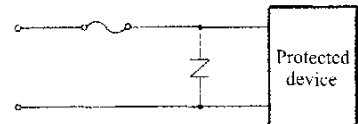

AC three-phase circuit

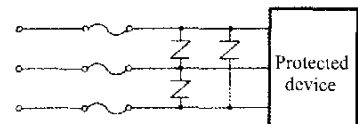

# VARISTORS JVR

## \* Varistor voltage selection in switching circuit protection

Power supply voltage	Type
12V AC	JVR- □□N220K
24V DC	JVR- □□N390K
100V DC	JVR- □□N151K
100V AC	JVR- □□N201K JVR- □□N241K JVR- □□N221K JVR- □□N271K

## \* Varistor voltage selection in telecommunication circuit protection

Power supply voltage	Type
12V DC	JVR- □□N220K JVR- □□N820K to JVR-□□N112K
24V DC	JVR- □□N390K JVR- □□N820K to JVR-□□N112K

## \* Fuse current selection if fuse being in series with varistor to protect from follow-on surge current after varistor damaged

Varistor	5	7	10	14	20
Nominal fuse current	≤ 1	≤ 3	≤ 5	≤ 10	≤ 15

## \*Line and Ground

AC/DC single-phase circuit

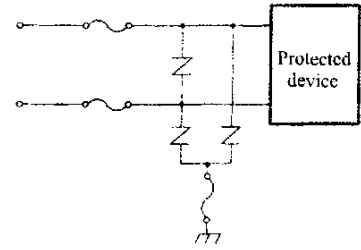

AC three-phase circuit

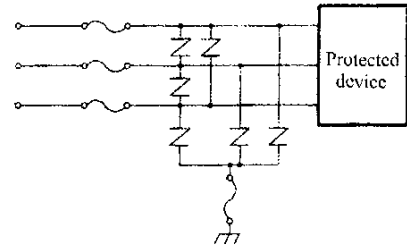

## \*Telecommunication Circuit Protection

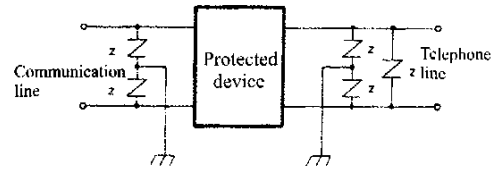

## \*Switching Circuit Protection

Relay protection



Spark elimination

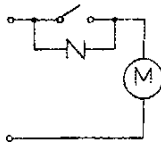

Semiconductor protection

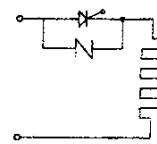

Surge protection of signal line

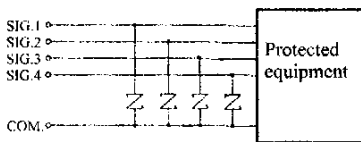

Fire alarm system

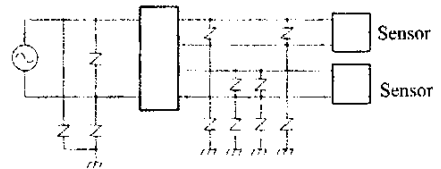

Thyristor protection

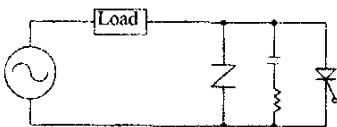

Triac protection

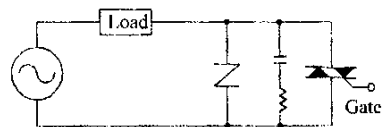

## VARISTORS JVR

**Solenoid**

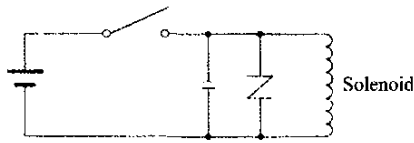

**Contact protection**

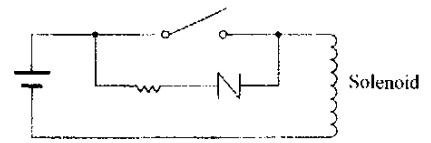

**Stove, boiler**

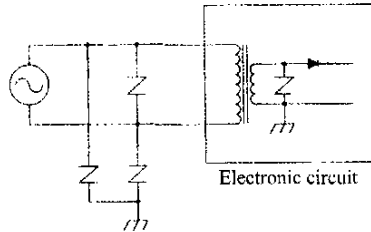

**Brake, clutch**

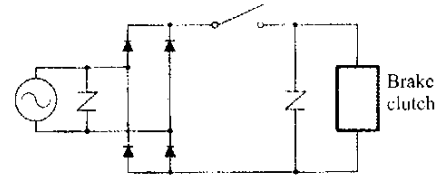

### CHECK LIST IN SERIES AND PARALLEL OPERATION OF VARISTORS

Item	SERIES	PARALLEL
Objective	Higher voltage capability Higher energy capability (No selection is required)	Higher current capability Higher energy capability (Selection is required)
Application Range	All voltages and currents.	All voltages-but high currents, i.e., >100A.
Models Applicable	All, must have same withstanding surge current ratings.	All models
Precautions	Withstanding surge current ratings must be equal.	Must be identical voltage rated models. Must test and select units for similar V-I characteristics.
Effect on Ratings	Current ratings that of single device. Voltage ratings additive. Energy ratings additive. Clamp voltages additive.	Current ratings function of current sharing. Voltage ratings that of single unit. Energy ratings as above in proportion to current sharing. Clamp voltages determined by composite V-I characteristic of matched units.

### 突波吸收器以串聯及並聯方式使用應確認的項目

項目	串聯	並聯
目的	較高電壓。 較高能量。 (不須挑選)	較大電流。 較高能量。 (須要挑選)
應用範圍	所有電壓及電流。	所有電壓, 但較大電流(>100A)
型號適用性	須有相同的額定突波耐量。	所有型號。
注意事項	額定突波耐量必須相同。	必須是單一額定電壓。 必須挑選類似的V-I特性。
對額定值的影響	與單一元件額定電流相同 額定電壓增加。 額定能量增加。 殘壓增加。	額定電流決定於電流分配方式。 與單一元件額定電壓相同。 額定能量與電流分配成正比。 殘壓決定於合成之V-I曲線。