

LW26-10



LW26-20



LW26-32



LW26-63



LW26-160



LW26 Series Rotary Switches

◆ Introduction

The LW26 series rotary switch mainly applies in 440V and below, AC 50Hz or 240V and below DC circuits. For breaking and closing, change-over of circuits under manual un-frequent operation. And the typical application are: control of 3 phase motors, control switch of switch gear, control switch of instruments, and control switch of machinery and welding machine.

The series comply the GB 1404803, GB 14048.5 and IEC 60947-3, IEC 60947-5-1.

The LW26 series have 7 current ratings: 10A, 20A, 25A, 32A, 63A, 125A and 160A.

The LW26 series rotary were designed for multiple functions, have wide variety of applications.

The LW26-10, LW26-20, LW26-25, and LW26-32F have finger prove terminals.

LW26 series rotary switch are an excellent substitute for LW2, LW5, LW6, LW8, LW12, LW15, HZ5, HZ10, and HZ12.

The LW26 series rotary switch has two derivatives,

Working conditions

- (1) Ambient temperature Do Not exceed 40℃, and the average temperature, measured over a period of 24 hours, Do Not exceed 35℃.
- (2) Ambient temperature Do Not less than -5℃.
- (3) Should Not be installed above 2000m above sea level.
- (4) A clean environment was required.

LW26X-10



LW26-25



LW26-32



LW26-63



LW26-125



◆ Designation

Use as control switches

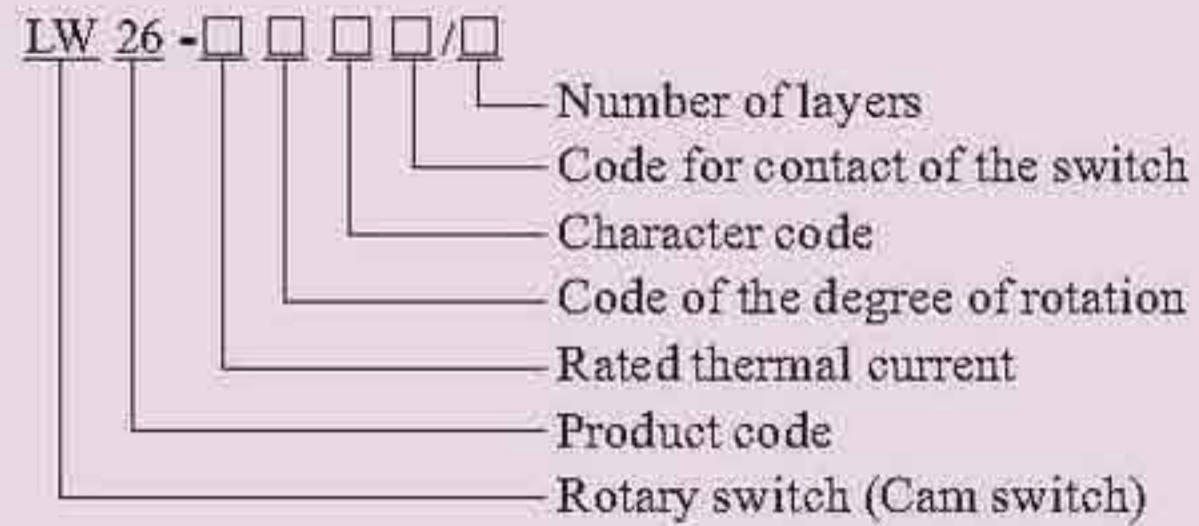

Re: Character code represent the rotating type, for instance, we have limited movement, spring return and limited movement with spring return.

Use as motor switch

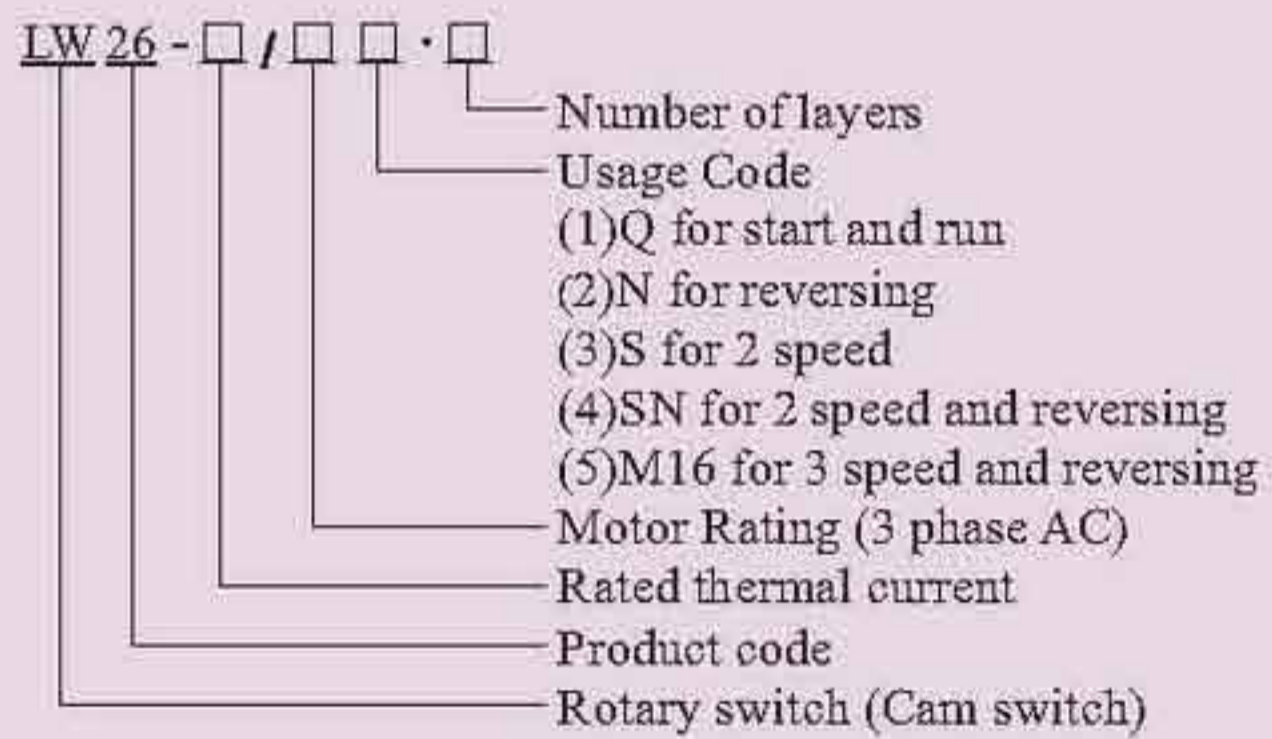

Re: switches in this category normally rotate at 60° . And the SN normally rotate at 45° .

Use as control switch for a main circuit

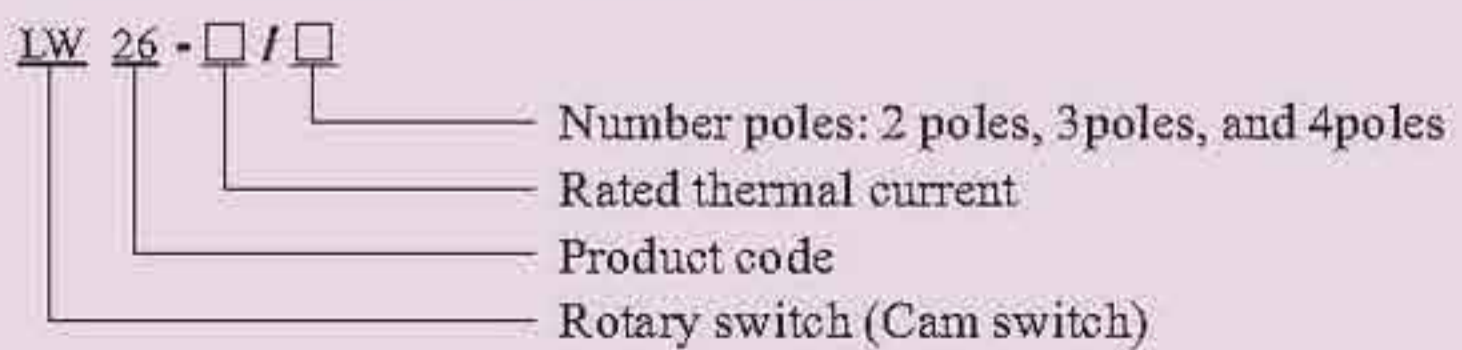

Re: switches in this category normally rotated at 60° .

◆ Classification

1 Classified by utilization:

- (1) Change-over switch;
- (2) Motor switch;
- (3) Control switch.

2 Classified by operation

- (1) Limited movement;
- (2) Spring return;
- (3) Limited movement with spring return.

3 Classified by contact system

- (1) Switches with limited movement could have 12 layers in maximum (for 32A and below), and for 63A and above could have 8 layers in maximum;
- (2) Switches with spring return could have 3 layers in maximum;
- (3) Motor switches could have 6 layers in maximum.

4 Diagram for the operation and position of handle

Operation angle	Character code	Position of handle																											
		30° Rotation					45° Rotation					60° Rotation					90° Rotation												
Spring return	A					0°	30°																						
	B					30°	0°	30°																					
Limited movement	C					0°	30°											0°	60°		0°	90°							
	D					30°	0°	30°										60°	0°	60°	90°	0°	90°						
	E					30°	0°	30°	60°									90°	30°	30°	90°	90°	0°	90°	180°				
	F					60°	30°	0°	30°	60°								90°	45°	0°	45°	90°	90°	30°	30°	90°	150°		
	G					60°	30°	0°	30°	60°	90°							90°	45°	0°	45°	90°	135°	150°	90°	30°	30°	90°	150°
	H					90°	60°	30°	0°	30°	60°	90°						135°	90°	45°	0°	45°	90°	135°					
	I					90°	60°	30°	0°	30°	60°	90°	120°					135°	90°	45°	0°	45°	90°	135°	180°				
	J					120°	90°	60°	30°	0°	30°	60°	90°	120°															
	K					120°	90°	60°	30°	0°	30°	60°	90°	120°	150°														
	L					150°	120°	90°	60°	30°	0°	30°	60°	90°	120°	150°													
	M					150°	120°	90°	60°	30°	0°	30°	60°	90°	120°	150°	180°												
	N																												
	P																												
	Limited movement with spring return	Z					30°	0°	60°																				
						60°	30°	0°	30°	60°																			
						30°	0°																						

◆ Escutcheon plate and Handle

Escutcheon plate

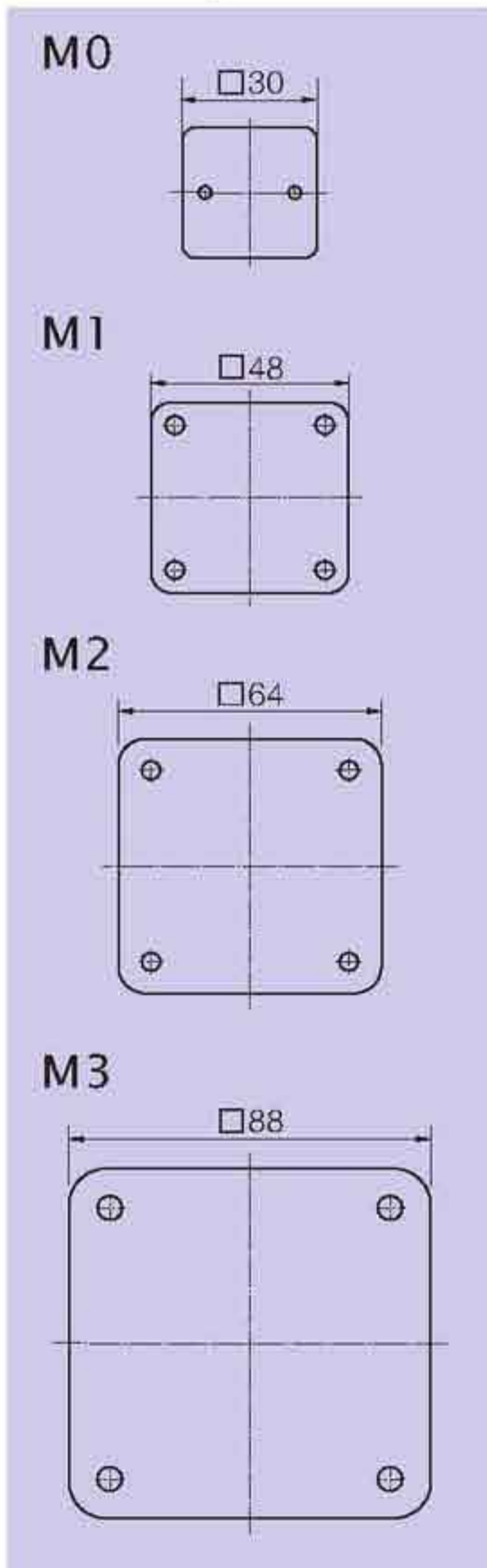

Type of handle

Type of handle	Color	Escutcheon plate				Type of handle	Color	Escutcheon plate			
		M0	M1	M2	M3			M0	M1	M2	M3
R 	Black Red White Gray	●	●	●		I 	Black Red White Gray	●	●	●	
F 	Black Red White Gray	●	●			B 	Black Red White Gray		●		
H 	Black Red White Gray				●	L 	Black Red White Gray			●	
P 	Black Red White Gray				●	K 	Black Red White Gray			●	●

Re: ● Standard, ● Optional.

Product	Escutcheon plate							Type of handle							Rotating angle				Maximum Number of layers		
	M0	M1	M1B	M2	M2B	M3	R	F	I	B	H	L	P	K	30°	45°	60°	90°	12	10	8
LW26-10	●								●						●	●	●	●			●
LW26X-10	●								●						●	●	●	●			●
LW26-20		●	●	●	●		●	●	●	●	●	●	●	●	●	●	●	●			●
LW26X-20		●	●	●	●		●	●	●	●	●	●	●	●	●	●	●	●			●
LW26-25		●	●	●	●		●	●	●	●	●	●	●	●	●	●	●	●			●
LW26-32				●	●	●	●	●	●		●	●	●	●	●	●	●	●			●
LW26-32F				●	●	●	●	●	●		●	●	●	●	●	●	●	●			●
LW26-63				●	●	●	●	●	●		●	●	●	●	●	●	●	●			●
LW26-125						●	●						●	●	●	●	●				●
LW26-160						●	●						●	●	●	●	●				●

Re: M1B M2B Platet should be installed by self tapping screw.

◆ Technical parameters

Description		LW26-10		LW26-20		LW26-25		LW26-32		LW26-63		LW26-125		LW26-160	
Rated thermal current I _{th}	A	10		20		25		32		63		125		160	
Rated working voltage U _e	V	240	440	240	440	240	440	240	440	240	440	240	440	240	440
Rated working current I _e															
AC-21A AC-22A	A	10	10	20	20	25	25	32	32	63	63	100	100	150	150
AC-23A	A	7.5	7.5	15	15	22	22	30	30	57	57	90	90	135	135
AC-2	A	7.5	7.5	15	15	22	22	30	30	57	57	90	90	135	135
AC-3	A	5.5	5.5	11	11	15	15	22	22	36	36	75	75	95	95
AC-4	A	1.75	1.75	3.5	3.5	6.5	6.5	11	11	15	15	30	30	55	55
AC-15	A	2.5	1.5	5	4	8	5	14	6						
Power P															
AC-23A	KW	1.8	3	3.7/2.5	7.5/3.7	5.5/3	11/5.5	7.5/4	15/7.5	15/10	30/18.5	30/15	45/22	37/22	75/37
AC-2	KW	2.5	3.7	4	7.5	5.5	11	7.5	15	18.5	30	30	45	37	55
AC-3	KW	1.5	2.2	3/2.2	5.5/3	4/3	7.5/3.7	5.5/4	11/5.5	11/8	18.5/11	15/7.5	30/13	22/11	37/18.5
AC-4	KW	0.37	0.55	0.55/0.75	1.5/1.5	1.5/1.1	3/2.2	2.7/1.5	5.5/3	5.5/2.4	7.5/4	6/3	12/5.5	10/4	15/7.5

Re: Neutral;

Re: The power under: AC-23A, AC-3, AC-4 are in three phase three pole, and the divider represents the power under single phase two pole.

Mechanical life

Mechanical life without load: $0.1 \cdot 10^6$ times, operation frequency is 120 times/h.

Mechanical life with load: $0.03 \cdot 10^6$ times operation frequency is 120 times/h.

Order procedure

When you place an order please specify the contact diagram of the product you require. The LW26 Series rotary have the similar contact diagram as the other rotary switches like LW2D, LW5D, LW6D, LW8D, LW12, LW15, HZ5D and HZ25D. Our factory have published 《The General Contact Diagram for Cansen Rotary Switches》 Which will help you to specify the contact diagram.

In addition please specify the current rating, mounting plate, handle type, color and quantity as well.

For instance:

When order and 20A, rotary angle 60° , character code C, contact diagram code 5391, M1 plate, black R handle switch 20 units.

The order can be:

LW26-20 • 6C5391/2 A11R (M1 R) 20units.

Due to the update of the technologies, we reserve the right of update the catalog the without further notices.

◆ Dimensions

Dimensions and installation

Square escutcheon plate and rectangular escutcheon plate

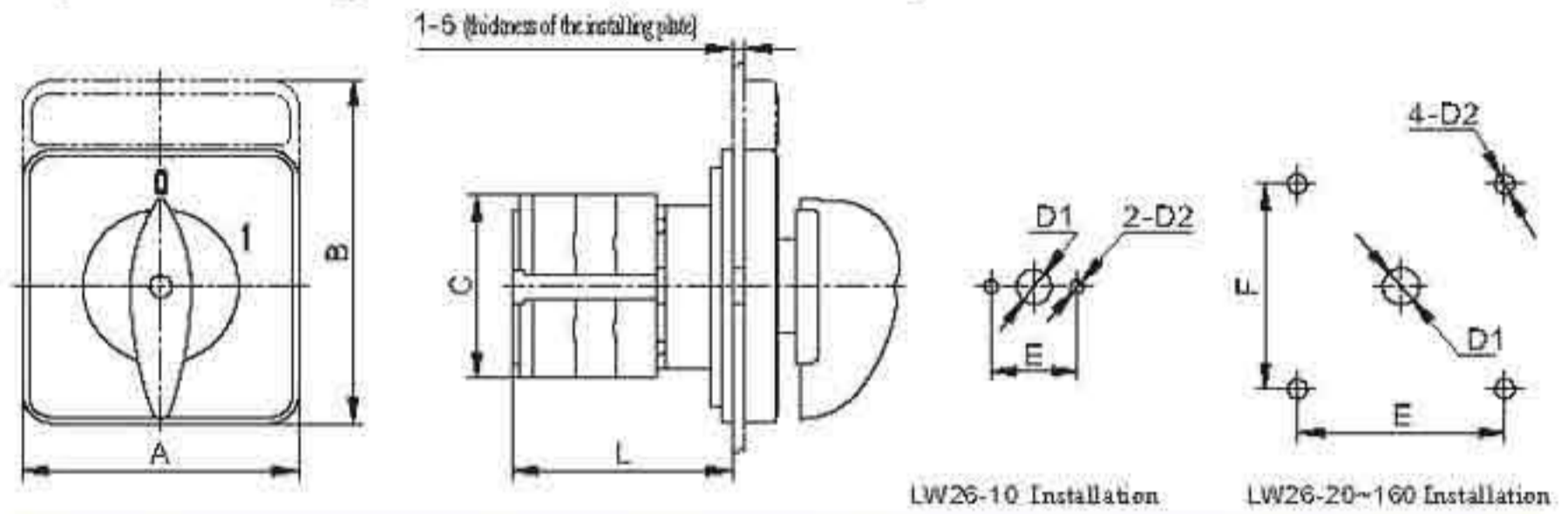

Description	Escutcheon plate	Dimensions (mm)				Installation (mm)			
		A	B	C	L	E	F	D1	D2
LW26-10	M0 square	30	30	28	22+8n	20		f8	f3.2
LW26X-10	M0 square	30	30	28	26.5+12n	20		f8	f3.2
LW26-20	M1 square	48	48	43	22+9.6n	36	36	f8.5	f4.5
	M2 square	64	64	43	25+9.6n	48	48	f10	f4.5
	M2 rectangular	64	80	43	25+9.6n	48	48	f10	f4.5
LW26X-20	M1 square	48	48	46	22+14n	36	36	f8.5	f4.5
	M1 rectangular	48	60	46	22+14n	36	36	f8.5	f4.5
	M2 square	64	64	46	25+14n	48	48	f10	f4.5
	M2 rectangular	64	80	46	25+14n	48	48	f10	f4.5
LW26-25	M1 square	48	48	45.2	23+12.8n	36	36	f8.5	f4.5
	M1 rectangular	48	60	45.2	23+12.8n	36	36	f8.5	f4.5
	M2 square	64	64	45.2	26.5+12.8n	48	48	f10	f4.5
	M2 rectangular	64	80	45.2	26.5+12.8n	48	48	f10	f4.5
LW26-32	M2 square	64	64	58	29.2+12.8n	48	48	f10	f4.5
	M2 rectangular	64	80	58	29.2+12.8n	48	48	f10	f4.5
LW26-32F	M1 square	48	48	48	23+14n	36	36	f8.5	f4.5
	M1 rectangular	48	60	48	23+14n	36	36	f8.5	f4.5
	M2 square	64	64	48	24.5+14n	48	48	f10	f4.5
	M2 rectangular	64	80	48	24.5+14n	48	48	f10	f4.5
LW26-63	M2 square	64	64	66	29.2+21.5n	48	48	f10	f4.5
	M2 rectangular	64	80	66	29.2+21.5n	48	48	f10	f4.5
LW26-125	M3 square	88	88	66	29.2+21.5n	68	68	f10	f4.5
	M3 rectangular	88	107	66	29.2+21.5n	68	68	f10	f4.5
LW26-160	M3 square	88	88	84	35+26.5n	68	68	f13	f6
	M3 rectangular	88	107	84	35+26.5n	68	68	f13	f6

Re: n for number of layers.

Single hole installation

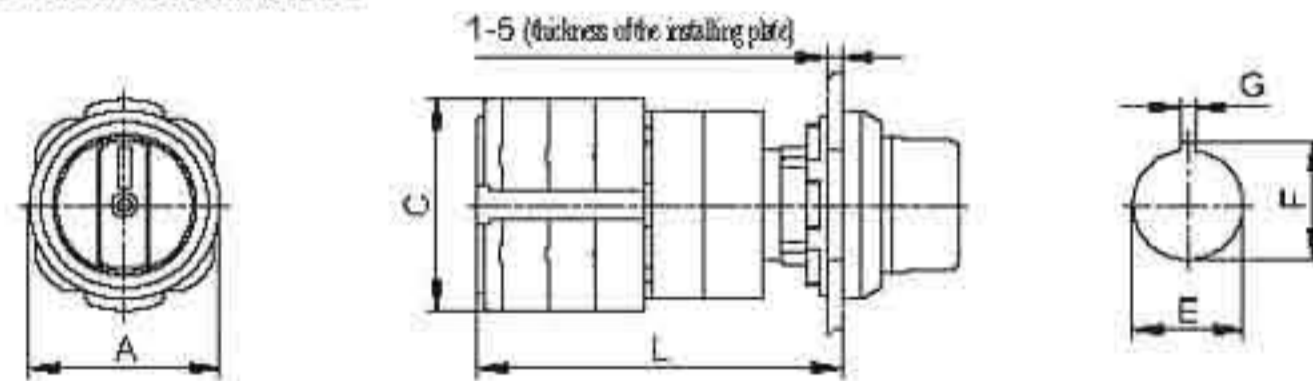



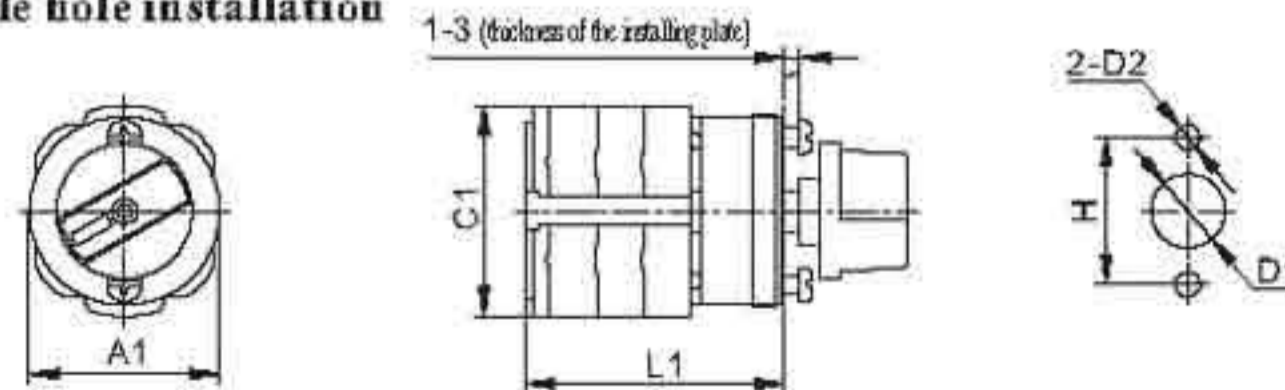





Double hole installation



Description	Dimensions (mm)						Installation (mm)					
	A	C	L	A1	C1	L1	E	F	G	H	D1	D2
LW26-10	129	28	35+8n				116.2	18	1.9			
LW26X-10	129	28	39+12n				116.2	18	1.9			
LW26-20	139	43	35+9.6n				130.5	33	4.8			
LW26-20	139	43	42+9.6n	139	43	24+9.6n	122.3	24.1	3.2	30	11.5	1.5
LW26X-20	139	46	42+14n	139	46	25+14n	122.3	24.1	3.2	30	11.5	1.5
LW26-25	139	45.2	42+12.8n	139	45.2	25+12.8n	122.3	24.1	3.2	30	11.5	1.5
LW26-32F	139	48	42+14n	139	48	25+14n	122.3	24.1	3.2	30	11.5	1.5

◆ Special type and optional extras

Type	Description			
LW26X-10 LW26X-20	LW26-10 Product with angled terminals 			
	LW26-10 <input type="checkbox"/> A10I	LW26X-10 <input type="checkbox"/> A10I	LW26X-20 <input type="checkbox"/> A31I	
LW26-32F	32A Fringer prove 			
	LW26-32F <input type="checkbox"/> A11I	LW26-32F <input type="checkbox"/> C55I	LW26-32F <input type="checkbox"/> C51S1	
LW26-10 LW26X-10 LW26-20 LW26X-20 LW26-25 LW26-32F	Single hole installation 			
	LW26X-10 <input type="checkbox"/> C10I	LW26-25 <input type="checkbox"/> C55I	LW26-20 <input type="checkbox"/> C11B	LW26-32F <input type="checkbox"/> C11I
LW26-20 LW26X-20 LW26-25 LW26-32F	Double hole installation 	Parallel installation 		
	LW26-25 <input type="checkbox"/> G88B	LW26-20 <input type="checkbox"/> D11R		
	Spring return with limited movement 	Spring return with multipal position 	Put out type 	
	LW26-20 <input type="checkbox"/> A11R	LW26-20 <input type="checkbox"/> A11R	LW26-20 <input type="checkbox"/> A32P1	

Type	Description			
LW26-20 LW26X-20 LW26-25	Single lock  LW26-25 □ • A11DS	B Type handle  LW26-25 □ • C55B	 LW26-20 □ • C55B	
LW26-20 LW26X-20 LW26-25 LW26-32F	Indicating light  LW26-20 □ • A66I	Indicating light with keylock  LW26-25 □ • A66S1		
LW26-20 LW26-25 LW26-32 LW26-63	Rectangle plate     LW26-20 □ • A21R LW26-20 □ • A41I LW26-32 □ • A22R LW26-63 □ • A42I			
LW26-20 LW26-25 LW26-32 LW26-63	Protective box      LW26-20 □ • E31I LW26-20 □ • E31GS LW26-20 □ • E11S1 LW26-20 □ • E11DS LW26-32 □ • E12R			
LW26-20 LW26-25 LW26-32 LW26-63 LW26-125 LW26-160	Rear installation  LW26-25 □ • B11R	Special type for DC circuits Re: For LW26-25 only.  LW26-25 □ • A11R2	Protective cover Re: For LW26-20, 25, 32F only.  LW26-20 □ • F11R	

LW26GS-25/04



LW26GS-32/04



LW26GS-63/04



LW26GS-125/04



LW26GS Series Pak-lock type switches

◆ Introduction

LW26GS series Pad-lock type switches are derivatives of LW26 series rotary switches. Installed in equipment where it requires a pad-lock to lock the switch in certain position. For instance, to fix the switch in ON position, to avoid the unauthorized personnel from operating the switch.

LW26GS series Pad-lock type switch complies with the GB 14048.3 and IEC 60947.3.

◆ Classification

(1)the LW26GS switch has 6 current ratings: 20A, 25A, 32A,63A, 125A and 160A.For 20A and 25A is able to install M1 or M2 plate, and for 32A and 63A is able to install M2 or M3 plate, for 125A and 160A is able to install M3 plate.The M1 plate is able to put 2 lockers, M2 and M3 is able to put 3 lockers.

(2)the LW 26GS switch has two types:

Normal type, black plate black handle

Quick stop type, has quick stop mark, yellow plate and red handle.

Technical parameters

Description		LW26GS-20	LWGS26-25	LWGS26-32	LWGS26-63	LWGS26-125	LWGS26-160
Rated working voltage U_e	V	440	440	440	440	440	440
Rated thermal current I_{th}	A	20	25	32	63	125	160
Rated working current I_e							
AC-21A	A	20	25	32	63	100	150
AC-22A	A	20	25	32	63	100	150
AC-23A	A	15	22	30	57	90	135
Power P							
AC-23A	KW	7.5	11	15	30	45	75
Operation							
Non-load		8500	8500	8500	8500	8500	8500
Load		1500	1500	1500	1500	1500	1500
Total		10 000	10 000	10 000	10 000	10 000	10 000

LW26GS-20/04-1 M1



LW26GS-20/04-2 M2



LW26GS-63/04-2 M3



LW26GS-160/04



Dimension and installation

LW26GS-□/□-1

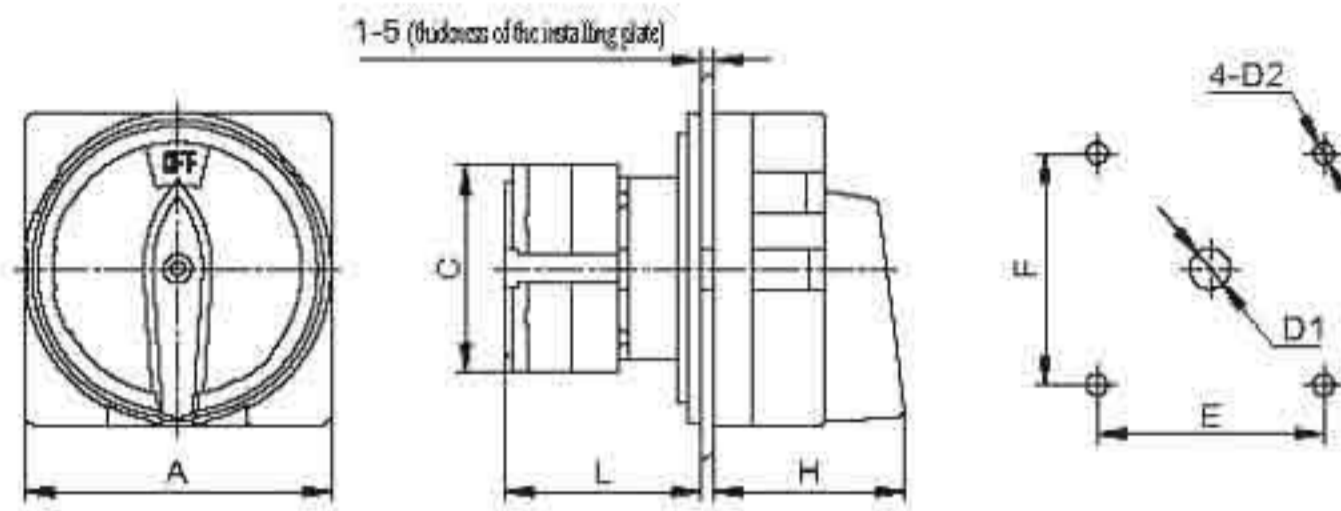

Description	Escutcheon plate	Dimensions (mm)				Installation (mm)			
		A	C	L	H	E	F	D1	D2
LW26GS-20	M1	□48	43	42	33	36	36	f8.5	f4.5
LW26GS-20	M2	□64	43	43	42	48	48	f8.5	f4.5
LW26GS-25	M1	□48	45.2	50	33	36	36	f8.5	f4.5
LW26GS-25	M2	□64	45.2	51	42	48	48	f8.5	f4.5
LW26GS-32	M2	□64	58	55	42	48	48	f10	f4.5
LW26GS-32	M3	□88	58	55	52	68	68	f13	f6
LW26GS-63	M2	□64	66	72.5	42	48	48	f10	f4.5
LW26GS-63	M3	□88	66	72.5	52	68	68	f13	f6
LW26GS-125	M3	□88	84	88	52	68	68	f13	f6
LW26GS-160	M3	□88	88	100	52	68	68	f13	f6

LW26GS-□/□-2

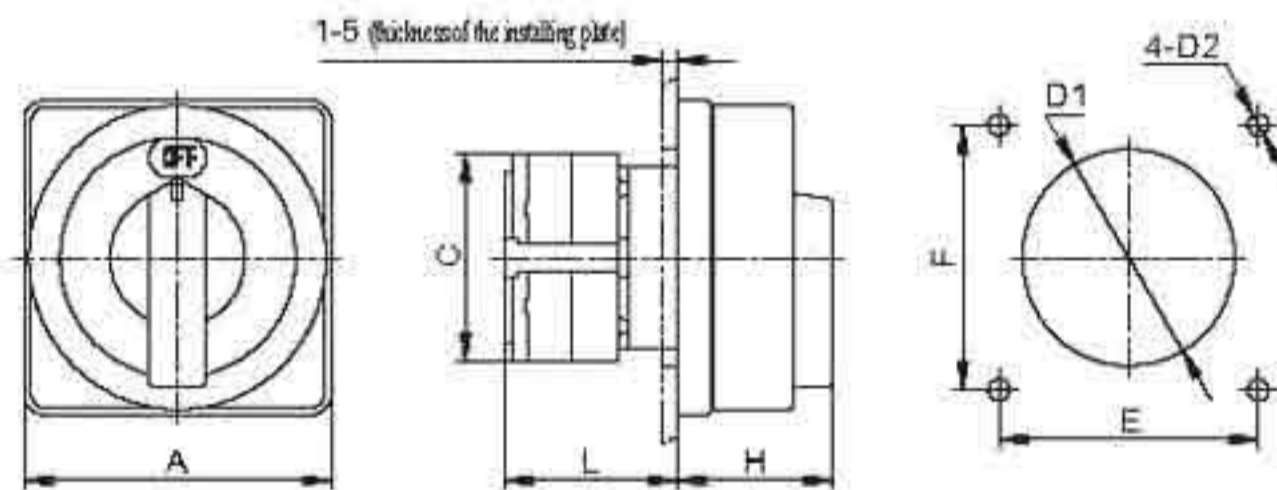

Description	Dimensions (mm)				Installation (mm)			
	A	C	L	H	E	F	D1	D2
LW26GS-20	□64	43	37.5	34	55	55	f45	f4.5
LW26GS-25	□64	45.2	45	34	55	55	f47	f4.5

LW26S Key-lock type switch



◆ Introduction

LW26S Key-lock type switches are derivatives of LW26 rotary switches. Installed in equipments, which requires a key to lock the switch. It prevents the mis-operation of the equipments from the unthorised personnel.

LW26S Key-lock type switches comply with the GB 14048.3 and IEC 60947-3.

Technical parameter

Description		LW26S-10	LW26S-20	LW26S-25	LW26S-32	LW26S-63
Rated working voltage Ue	V	440	440	440	440	440
Rated thermal current Ith	A	10	20	25	32	63
Rated working current Ie						
AC-21A	A	10	20	25	32	63
AC-22A	A	10	20	25	32	63
AC-23A	A	7	15	22	30	57
Power P						
AC-23A	kW	3	7.5	11	15	30

Dimensions and installation

LW26S S1 Type switch

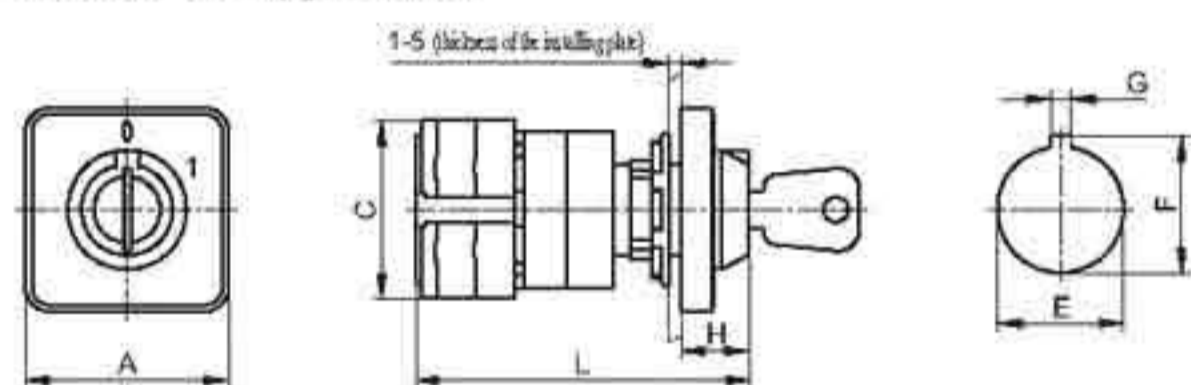

Description	Dimension (mm)				Installation (mm)		
	A	C	H	L	E	F	G
LW26S-10	□30	28	8.5	71.5	16.2	18	1.9
LW26S-20	□48	43	15.6	76.5	122.3	24.1	3.2
LW26S-20	□64	43	15.6	76.5	122.3	24.1	3.2
LW26S-25	□48	45.2	15.6	83	122.3	24.1	3.2
LW26S-25	□64	45.2	15.6	83	122.3	24.1	3.2
LW26S-32F	□48	48	15.6	86.5	122.3	24.1	3.2
LW26S-32F	□64	48	15.6	86.5	122.3	24.1	3.2

LW26S S2 Type switch

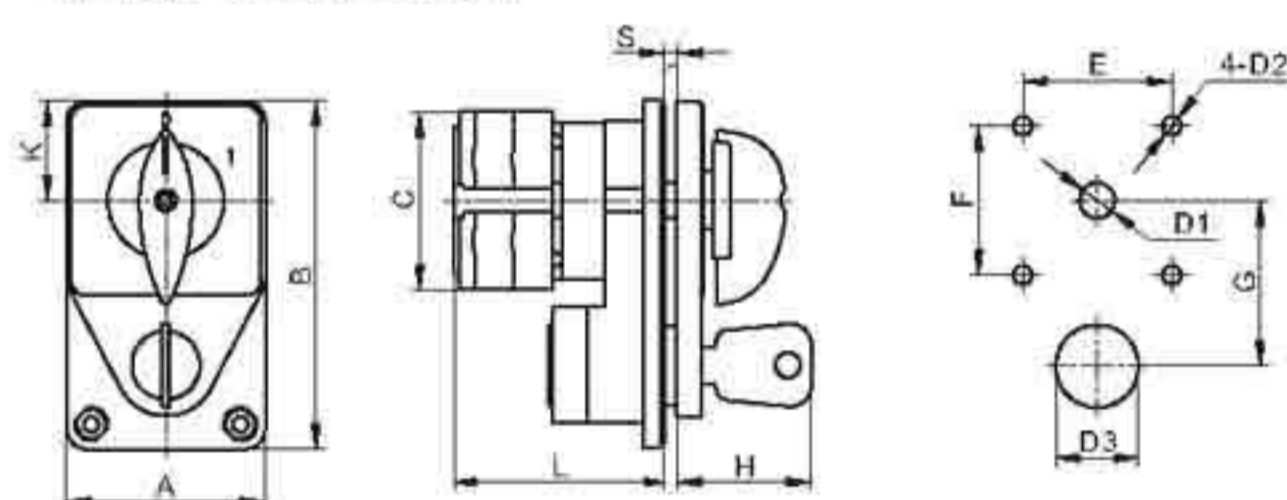

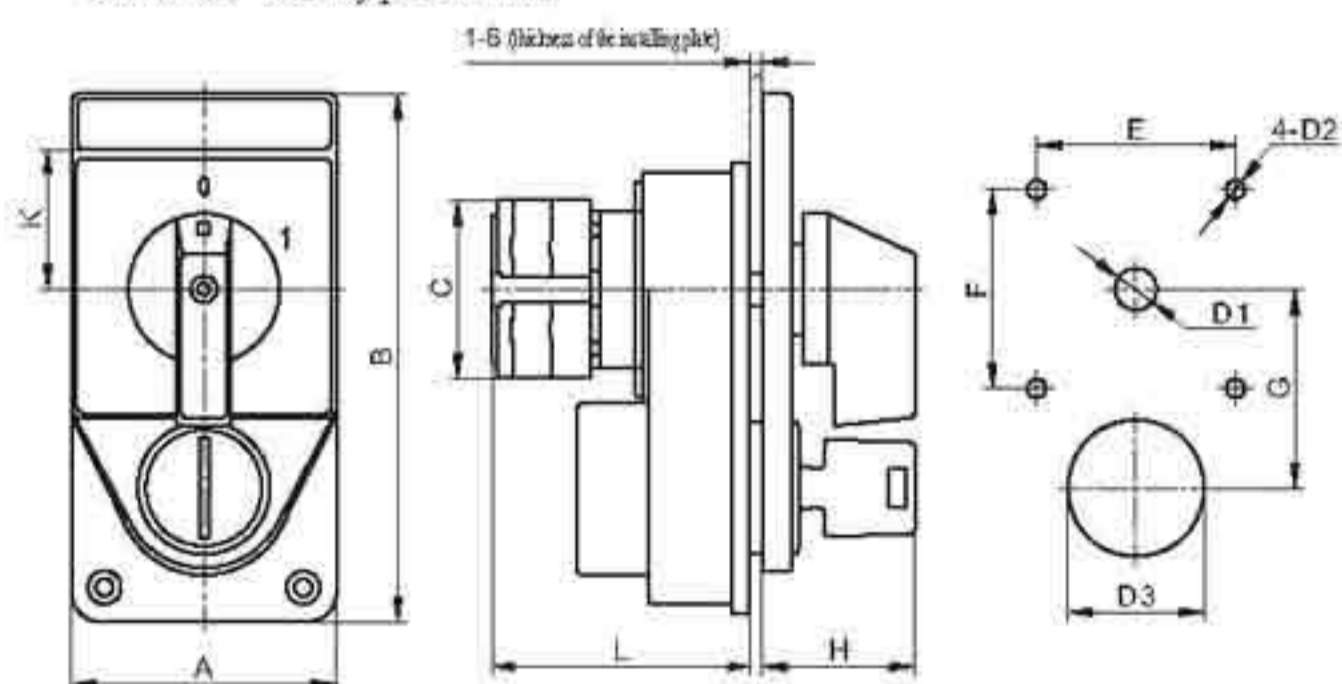

Description	Dimension (mm)							Installation (mm)					
	A	B	K	C	L	H	S	E	F	G	D1	D2	D3
LW26S-20	48	84	24	43	51.5	32.5	1~4	36	36	40	18.5	14.5	120
LW26S-25	48	84	24	45.2	58	32.5	1~4	36	36	40	18.5	14.5	120
LW26S-32	64	112	32	58	72	34	1~6	48	48	48	110	14.5	134
LW26S-32F	48	84	24	48	61.5	32.5	1~4	36	36	40	18.5	14.5	120
LW26S-63	64	112	32	66	79	34	1~6	48	48	48	110	14.5	134

LW26S S3 Type switch

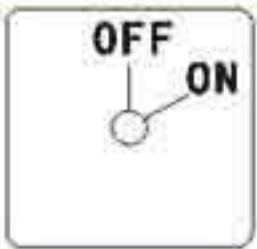
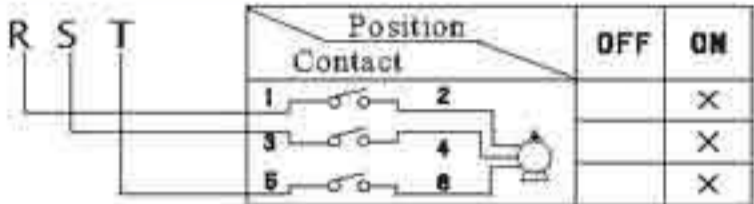
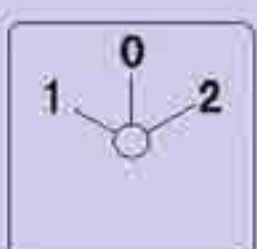
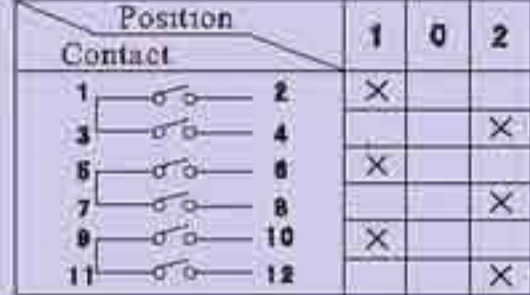
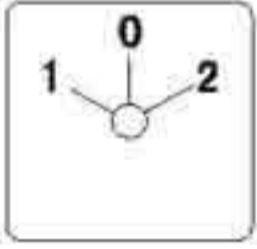
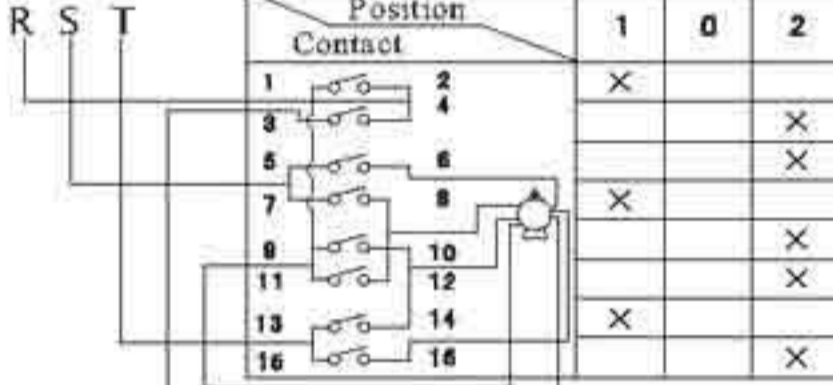
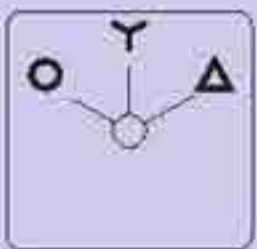
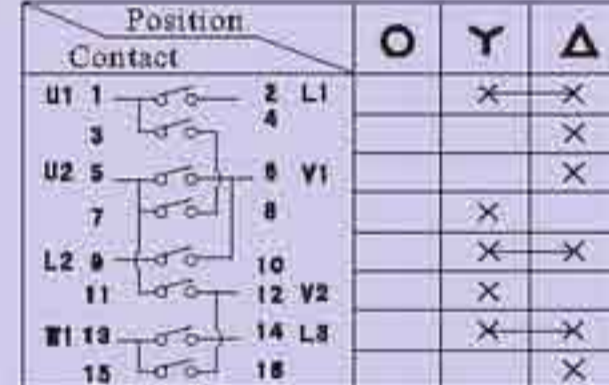
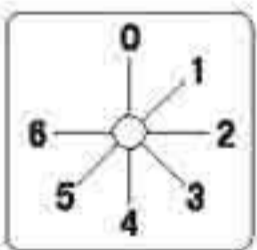

Description	Dimension (mm)							Installation (mm)					
	A	B	K	C	L	H	S	E	F	G	D1	D2	D3
LW26S-20	64	126.5	32	43	51.5	34		48	48	48	110	14.5	134
LW26S-25	64	126.5	32	45.2	58	34		48	48	48	110	14.5	134
LW26S-32	64	126.5	32	58	72	34		48	48	48	110	14.5	134
LW26S-32F	64	126.5	32	48	61.5	34		48	48	48	110	14.5	134
LW26S-63	64	126.5	32	66	79	34		48	48	48	110	14.5	134

◆ Selection of typical contact diagrams

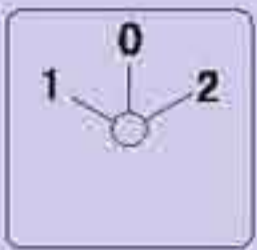
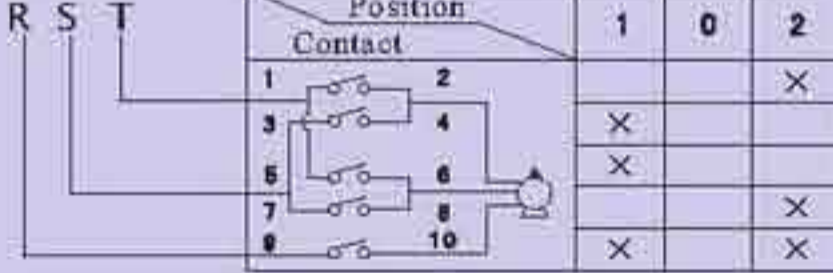
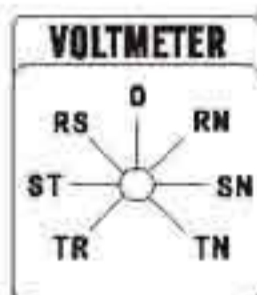
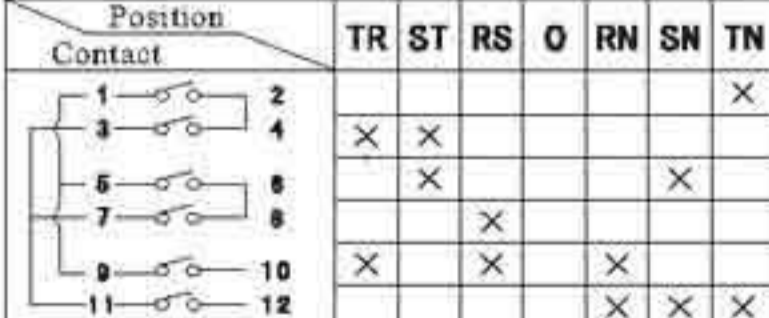
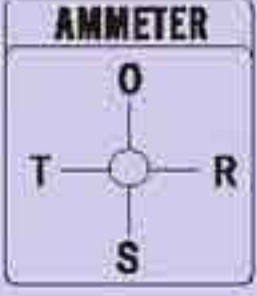
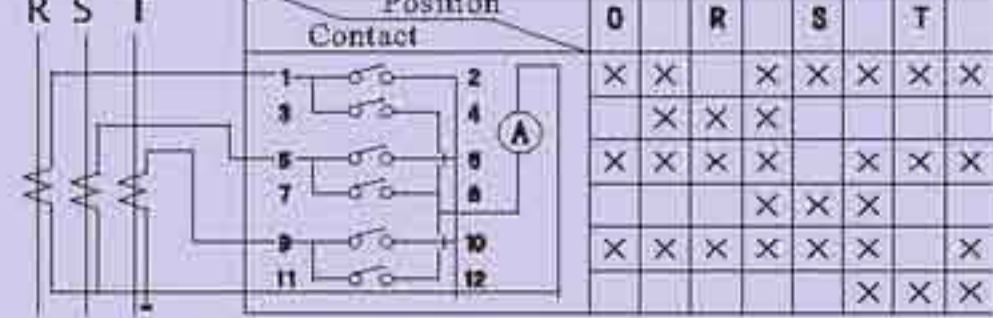
Function	Usage code or character code	Marks of plate	Contact diagrams																																																								
Start and run of motor	Q		 <table border="1" data-bbox="1354 727 1470 860"> <thead> <tr> <th>Position</th> <th>OFF</th> <th>ON</th> </tr> </thead> <tbody> <tr> <td>Contact 1</td> <td></td> <td>×</td> </tr> <tr> <td>Contact 3</td> <td></td> <td>×</td> </tr> <tr> <td>Contact 5</td> <td></td> <td>×</td> </tr> </tbody> </table>	Position	OFF	ON	Contact 1		×	Contact 3		×	Contact 5		×																																												
Position	OFF	ON																																																									
Contact 1		×																																																									
Contact 3		×																																																									
Contact 5		×																																																									
	D60306		 <table border="1" data-bbox="1354 905 1470 1098"> <thead> <tr> <th>Position</th> <th>1</th> <th>0</th> <th>2</th> </tr> </thead> <tbody> <tr> <td>Contact 1</td> <td>×</td> <td></td> <td></td> </tr> <tr> <td>Contact 3</td> <td></td> <td></td> <td>×</td> </tr> <tr> <td>Contact 5</td> <td>×</td> <td></td> <td></td> </tr> <tr> <td>Contact 7</td> <td></td> <td></td> <td>×</td> </tr> <tr> <td>Contact 9</td> <td>×</td> <td></td> <td></td> </tr> <tr> <td>Contact 11</td> <td></td> <td></td> <td>×</td> </tr> </tbody> </table>	Position	1	0	2	Contact 1	×			Contact 3			×	Contact 5	×			Contact 7			×	Contact 9	×			Contact 11			×																												
Position	1	0	2																																																								
Contact 1	×																																																										
Contact 3			×																																																								
Contact 5	×																																																										
Contact 7			×																																																								
Contact 9	×																																																										
Contact 11			×																																																								
Two speed motor start and run of motor	S		 <table border="1" data-bbox="1354 1142 1522 1394"> <thead> <tr> <th>Position</th> <th>1</th> <th>0</th> <th>2</th> </tr> </thead> <tbody> <tr> <td>Contact 1</td> <td>×</td> <td></td> <td></td> </tr> <tr> <td>Contact 3</td> <td></td> <td></td> <td>×</td> </tr> <tr> <td>Contact 5</td> <td></td> <td></td> <td>×</td> </tr> <tr> <td>Contact 7</td> <td>×</td> <td></td> <td></td> </tr> <tr> <td>Contact 9</td> <td></td> <td></td> <td>×</td> </tr> <tr> <td>Contact 11</td> <td></td> <td></td> <td>×</td> </tr> <tr> <td>Contact 13</td> <td>×</td> <td></td> <td></td> </tr> <tr> <td>Contact 15</td> <td></td> <td></td> <td>×</td> </tr> </tbody> </table>	Position	1	0	2	Contact 1	×			Contact 3			×	Contact 5			×	Contact 7	×			Contact 9			×	Contact 11			×	Contact 13	×			Contact 15			×																				
Position	1	0	2																																																								
Contact 1	×																																																										
Contact 3			×																																																								
Contact 5			×																																																								
Contact 7	×																																																										
Contact 9			×																																																								
Contact 11			×																																																								
Contact 13	×																																																										
Contact 15			×																																																								
	D60411		 <table border="1" data-bbox="1354 1439 1522 1691"> <thead> <tr> <th>Position</th> <th>0</th> <th>Y</th> <th>Δ</th> </tr> </thead> <tbody> <tr> <td>Contact 1</td> <td></td> <td>×</td> <td>×</td> </tr> <tr> <td>Contact 3</td> <td></td> <td></td> <td>×</td> </tr> <tr> <td>Contact 5</td> <td></td> <td></td> <td>×</td> </tr> <tr> <td>Contact 7</td> <td></td> <td>×</td> <td></td> </tr> <tr> <td>Contact 9</td> <td></td> <td>×</td> <td>×</td> </tr> <tr> <td>Contact 11</td> <td></td> <td>×</td> <td></td> </tr> <tr> <td>Contact 13</td> <td></td> <td>×</td> <td>×</td> </tr> <tr> <td>Contact 15</td> <td></td> <td></td> <td>×</td> </tr> </tbody> </table>	Position	0	Y	Δ	Contact 1		×	×	Contact 3			×	Contact 5			×	Contact 7		×		Contact 9		×	×	Contact 11		×		Contact 13		×	×	Contact 15			×																				
Position	0	Y	Δ																																																								
Contact 1		×	×																																																								
Contact 3			×																																																								
Contact 5			×																																																								
Contact 7		×																																																									
Contact 9		×	×																																																								
Contact 11		×																																																									
Contact 13		×	×																																																								
Contact 15			×																																																								
7 position with 0 position	H5881/3		 <table border="1" data-bbox="1249 1736 1543 1914"> <thead> <tr> <th>Position</th> <th>0</th> <th>1</th> <th>2</th> <th>3</th> <th>4</th> <th>5</th> <th>6</th> </tr> </thead> <tbody> <tr> <td>Contact 1</td> <td></td> <td>×</td> <td></td> <td></td> <td></td> <td></td> <td></td> </tr> <tr> <td>Contact 3</td> <td></td> <td></td> <td>×</td> <td></td> <td></td> <td></td> <td></td> </tr> <tr> <td>Contact 5</td> <td></td> <td></td> <td></td> <td>×</td> <td></td> <td></td> <td></td> </tr> <tr> <td>Contact 7</td> <td></td> <td></td> <td></td> <td></td> <td>×</td> <td></td> <td></td> </tr> <tr> <td>Contact 9</td> <td></td> <td></td> <td></td> <td></td> <td></td> <td>×</td> <td></td> </tr> <tr> <td>Contact 11</td> <td></td> <td></td> <td></td> <td></td> <td></td> <td></td> <td>×</td> </tr> </tbody> </table>	Position	0	1	2	3	4	5	6	Contact 1		×						Contact 3			×					Contact 5				×				Contact 7					×			Contact 9						×		Contact 11							×
Position	0	1	2	3	4	5	6																																																				
Contact 1		×																																																									
Contact 3			×																																																								
Contact 5				×																																																							
Contact 7					×																																																						
Contact 9						×																																																					
Contact 11							×																																																				
Start and run and reversing of motor	N		 <table border="1" data-bbox="1354 1973 1522 2151"> <thead> <tr> <th>Position</th> <th>1</th> <th>0</th> <th>2</th> </tr> </thead> <tbody> <tr> <td>Contact 1</td> <td></td> <td></td> <td>×</td> </tr> <tr> <td>Contact 3</td> <td>×</td> <td></td> <td></td> </tr> <tr> <td>Contact 5</td> <td></td> <td></td> <td>×</td> </tr> <tr> <td>Contact 7</td> <td></td> <td></td> <td>×</td> </tr> <tr> <td>Contact 9</td> <td>×</td> <td></td> <td>×</td> </tr> </tbody> </table>	Position	1	0	2	Contact 1			×	Contact 3	×			Contact 5			×	Contact 7			×	Contact 9	×		×																																
Position	1	0	2																																																								
Contact 1			×																																																								
Contact 3	×																																																										
Contact 5			×																																																								
Contact 7			×																																																								
Contact 9	×		×																																																								
3 phase Voltmeter with 0 position	YH5/3		 <table border="1" data-bbox="1249 2196 1543 2404"> <thead> <tr> <th>Position</th> <th>TR</th> <th>ST</th> <th>RS</th> <th>0</th> <th>RN</th> <th>SN</th> <th>TN</th> </tr> </thead> <tbody> <tr> <td>Contact 1</td> <td></td> <td></td> <td></td> <td></td> <td></td> <td></td> <td>×</td> </tr> <tr> <td>Contact 3</td> <td>×</td> <td>×</td> <td></td> <td></td> <td></td> <td></td> <td></td> </tr> <tr> <td>Contact 5</td> <td></td> <td>×</td> <td></td> <td></td> <td></td> <td>×</td> <td></td> </tr> <tr> <td>Contact 7</td> <td></td> <td></td> <td>×</td> <td></td> <td></td> <td></td> <td></td> </tr> <tr> <td>Contact 9</td> <td>×</td> <td>×</td> <td></td> <td>×</td> <td></td> <td></td> <td></td> </tr> <tr> <td>Contact 11</td> <td></td> <td></td> <td></td> <td>×</td> <td>×</td> <td>×</td> <td></td> </tr> </tbody> </table>	Position	TR	ST	RS	0	RN	SN	TN	Contact 1							×	Contact 3	×	×						Contact 5		×				×		Contact 7			×					Contact 9	×	×		×				Contact 11				×	×	×	
Position	TR	ST	RS	0	RN	SN	TN																																																				
Contact 1							×																																																				
Contact 3	×	×																																																									
Contact 5		×				×																																																					
Contact 7			×																																																								
Contact 9	×	×		×																																																							
Contact 11				×	×	×																																																					
Three phase Ammeter with 0 position	LH3/3		 <table border="1" data-bbox="1312 2448 1585 2656"> <thead> <tr> <th>Position</th> <th>0</th> <th>R</th> <th>S</th> <th>T</th> </tr> </thead> <tbody> <tr> <td>Contact 1</td> <td>×</td> <td>×</td> <td>×</td> <td>×</td> </tr> <tr> <td>Contact 3</td> <td>×</td> <td>×</td> <td>×</td> <td>×</td> </tr> <tr> <td>Contact 5</td> <td>×</td> <td>×</td> <td>×</td> <td>×</td> </tr> <tr> <td>Contact 7</td> <td></td> <td></td> <td>×</td> <td>×</td> </tr> <tr> <td>Contact 9</td> <td>×</td> <td>×</td> <td>×</td> <td>×</td> </tr> <tr> <td>Contact 11</td> <td></td> <td></td> <td></td> <td>×</td> </tr> </tbody> </table>	Position	0	R	S	T	Contact 1	×	×	×	×	Contact 3	×	×	×	×	Contact 5	×	×	×	×	Contact 7			×	×	Contact 9	×	×	×	×	Contact 11				×																					
Position	0	R	S	T																																																							
Contact 1	×	×	×	×																																																							
Contact 3	×	×	×	×																																																							
Contact 5	×	×	×	×																																																							
Contact 7			×	×																																																							
Contact 9	×	×	×	×																																																							
Contact 11				×																																																							