

# Braytron

FISA TEHNICA

MODEL

BY90-01312

DESCRIERE

BRY-21,3x15,3-100pcs/bag-PA66-WHT-CABLE TIES SCREW MOUNT

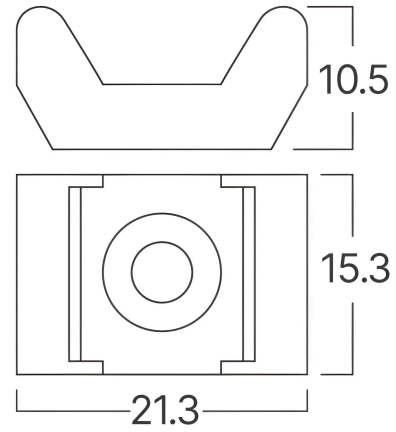

BRAYTRON SRL

MUNICIPIUL BUCUREȘTI, SECTOR 6, BLD. IULIU MANIU, NR.616, CORP B, ET.1,BUCUREȘTI,Sector 6(RO)

info@braytron.com

www.braytron.com

## General Characteristics

Model No	:	BY90-01312
Main Family	:	Electrical
Sub Family	:	Cable Ties
Type	:	Screw Mount
Body Color	:	White
Warranty	:	2 Years

## Electrical Characteristics

Material	:	PA66
Working Temperature	:	-40°C ~ +85°C

## Dimensions & Weight

P. Length	:	21,3 mm
P. Width	:	15,3 mm
P. Height	:	8,3 mm

## Package Informations

PCS/CTN	:	50
Length	:	55 cm
Width	:	40 cm
Height	:	17 cm
EAN	:	5949097753008