



Design Example Report

Title	3.6W Charger using TNY266P
Specification	Input: 85 – 264 VAC Output: 5.1V / 700mA
Application	Cell Phone Charger
Author	Power Integrations Applications Department
Document Number	DER-6
Date	February 4, 2004
Revision	1.0

Summary and Features

- Low Cost CVCC charger
- Low Parts Count
- Meets EMI with no Y-capacitor
- No load power consumption < 300 mW @ 230 Vac

The products and applications illustrated herein (including circuits external to the products and transformer construction) may be covered by one or more U.S. and foreign patents or potentially by pending U.S. and foreign patent applications assigned to Power Integrations. A complete list of Power Integrations' patents may be found at www.powerint.com

Table Of Contents

1	Introduction.....	3
2	Power Supply Specifications	3
3	Schematic.....	4
4	PCB Layout	4
5	Bill of Material.....	5
6	Power Supply Performance.....	6
6.1	Output Characteristic.....	6
6.1.1	V-I curve at different Input Voltages.....	6
6.1.2	V-I Curve at Different Temperatures	7
6.2	Efficiency.....	7
6.2.1	Efficiency vs. Input voltage.....	7
6.2.2	Efficiency vs. Output current	8
6.3	Output Ripple.	8
6.4	Transient Load Response	9
6.5	No load power consumption.....	9
7	Conducted EMI Measurement.....	10
8	Transformer Design.....	12
8.1	Transformer Winding.....	12
8.2	Electrical Specifications.....	12
8.3	Materials.....	12
8.4	Transformer Construction.....	13
8.5	Winding Instructions.....	14
9	Revision History	15

Important Notes:

Although this board is designed to satisfy safety isolation requirements, the engineering prototype has not been agency approved. Therefore, all testing should be performed using an isolation transformer to provide the AC input to the prototype board.

Design Reports contain a power supply design specification, schematic, bill of materials, and transformer documentation. Performance data and typical operation characteristics are included. Typically only a single prototype has been built.



Introduction.

This document describes the design for a 5.1V 700mA battery charger. The design is implemented using a TNY266 controller with an EF16 transformer in a flyback topology. This report includes the design specifications, performance, transformer design, and bill of materials.

1 Power Supply Specifications

The following table shows the supply specifications.

Description	Symbol	Min	Typ	Max	Units	Comment
Input						
Voltage	V_{IN}	85		264	V_{AC}	2 wire, no protective earth
Frequency	f_{LINE}		50/60		Hz	
Output						
Output Voltage	V_{OUT}	5		5.2	V	20 MHz Bandwidth
Output Ripple Voltage	V_{RIPPLE}			60	mV	
Output Current	I_{OUT}	650	700	750	A	
Total Output Power						
Continuous Output Power	P_{OUT}		3.64		W	
Ambient Temperature	T_{AMB}	0		50	°C	Free convection, Sea level



2 Schematic

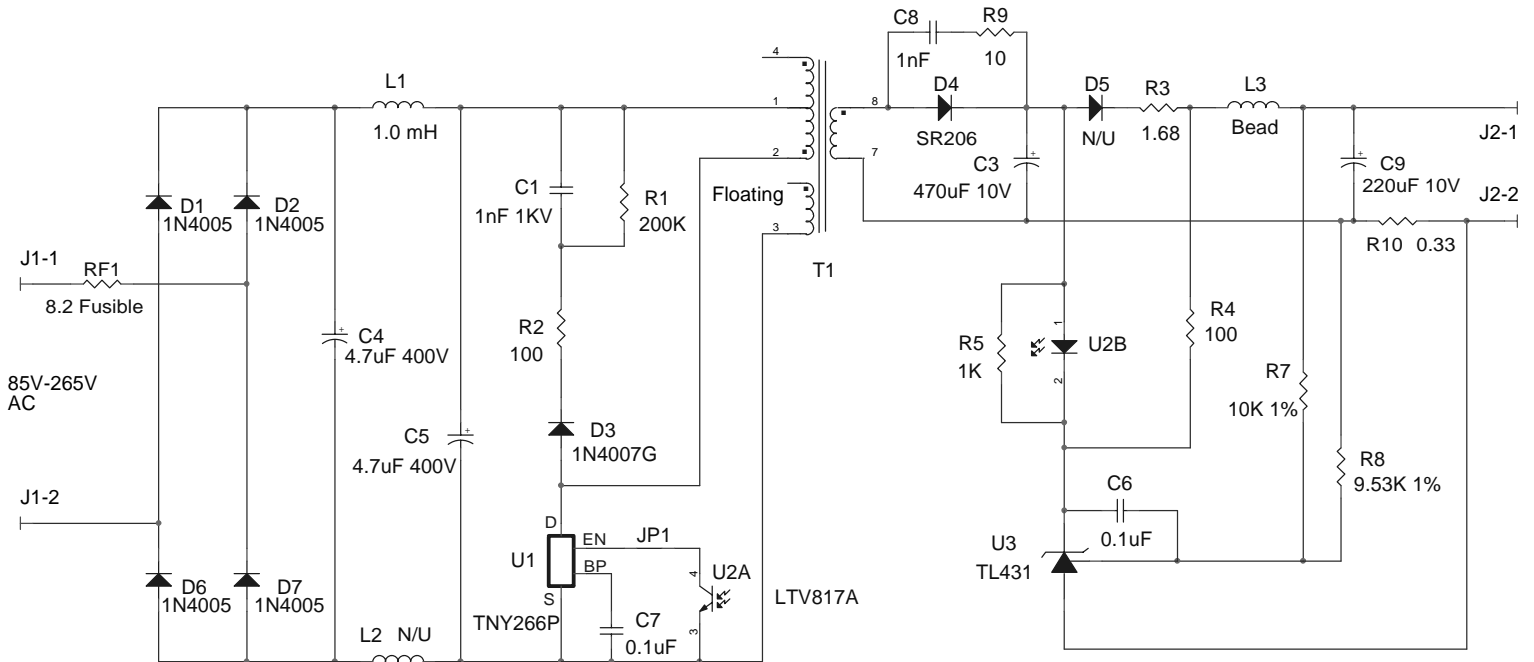

Figure 1 – Schematic

3 PCB Layout

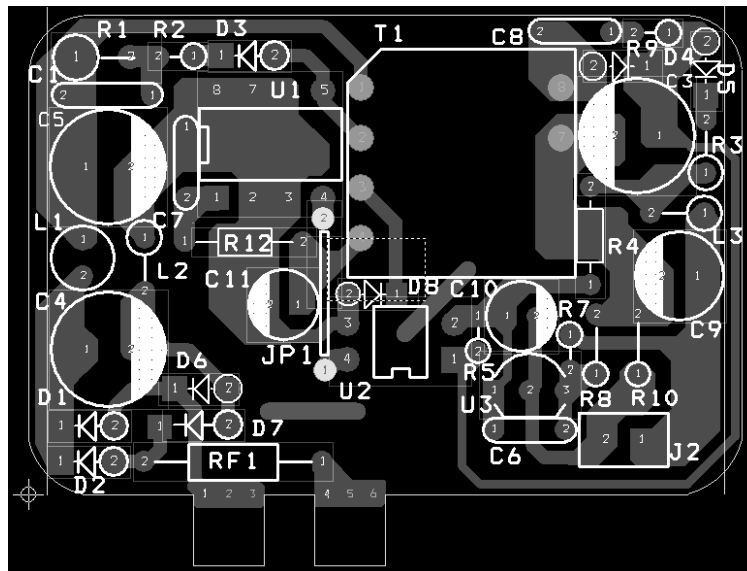

Figure 2 PCB layout

Notes: C11, D8, R12 are optional for a bias supply to further reduce no-load consumption.



4 Bill of Material

Item	Quantity	Reference	Part Description
1	2	C4, C5	4.7uF 400V, Electrolytic
2	1	C1	1nF 1KV, Ceramic Disk
3	1	C3	470uF, 10V, Low ESR
4	1	C9	220uF, 10V, Low ESR
5	2	C6, C7	0.1uF, 50V, Ceramic
6	1	C8	1nF 100V, Ceramic
7	4	D1, D2, D6, D7	1N4005, 1Amp, 600V
8	1	D3	1N4007G, 1A, 1KV, Glass Passive.
9	1	D4	SR206, 2A, 60V, Schottky
10	1	L1	1mH, Inductor
11	1	L3	Ferrite Bead
12	1	RF1	8.2 Ohm, 1W, Fusible Resistor
13	1	R1	200K, 1/2W
14	1	R2	100, 1/4W
15	1	R3	1.68, 2W
16	1	R4	100 1/8W
17	1	R5	1K, 1/8
18	1	R7	10.0K 1%, 1/8W
19	1	R8	9.53K 1%, 1/8W
20	1	R9	10, 1/4W
21	1	R10	0.33, 1W
22	1	T1	EF16 Custom Transformer
23	1	U1	TNY266P
24	1	U2	LTV817A
25	1	U3	TL431, 2.5V Reference



5 Power Supply Performance

Note: All measurements were made at the end of the output cable with a resistance of 0.25 Ω.

5.1 Output Characteristic.

5.1.1 V-I curve at different Input Voltages

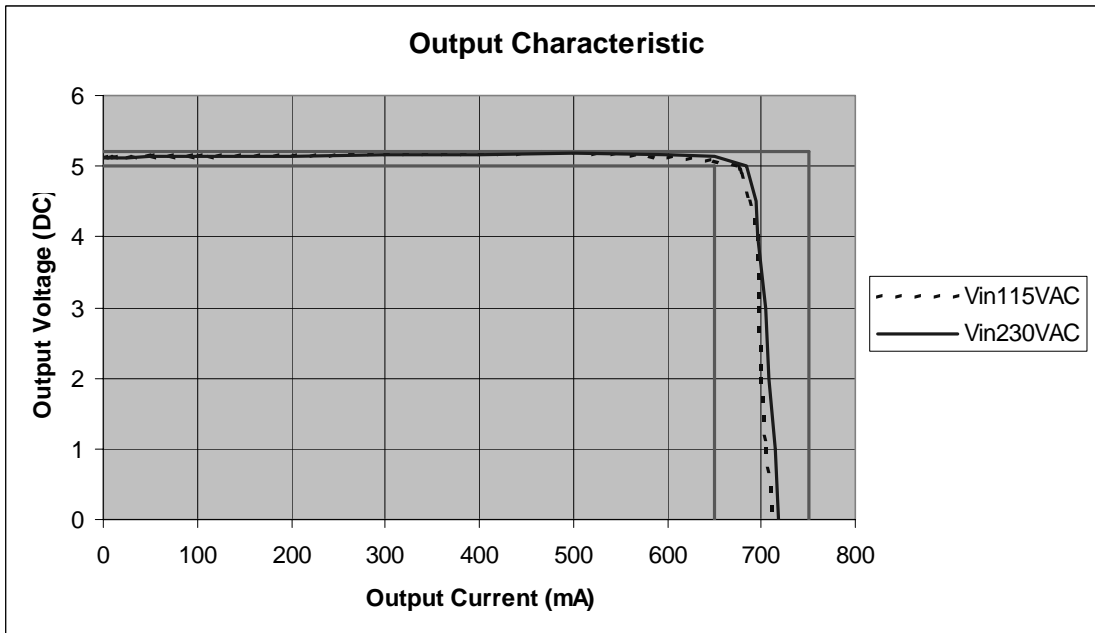

Figure 3 Typical output characteristic



5.1.2 V-I Curve at Different Temperatures

The data was taken at 115Vac, in a small box, with no airflow

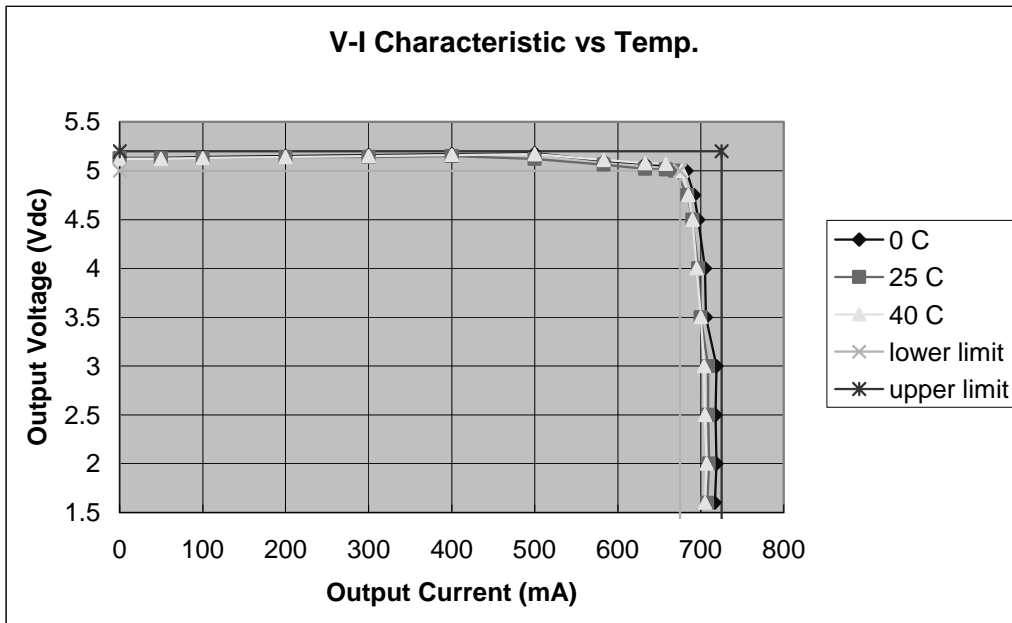

Figure 4 Output Characteristic at different temperatures

5.2 Efficiency

5.2.1 Efficiency vs. Input voltage

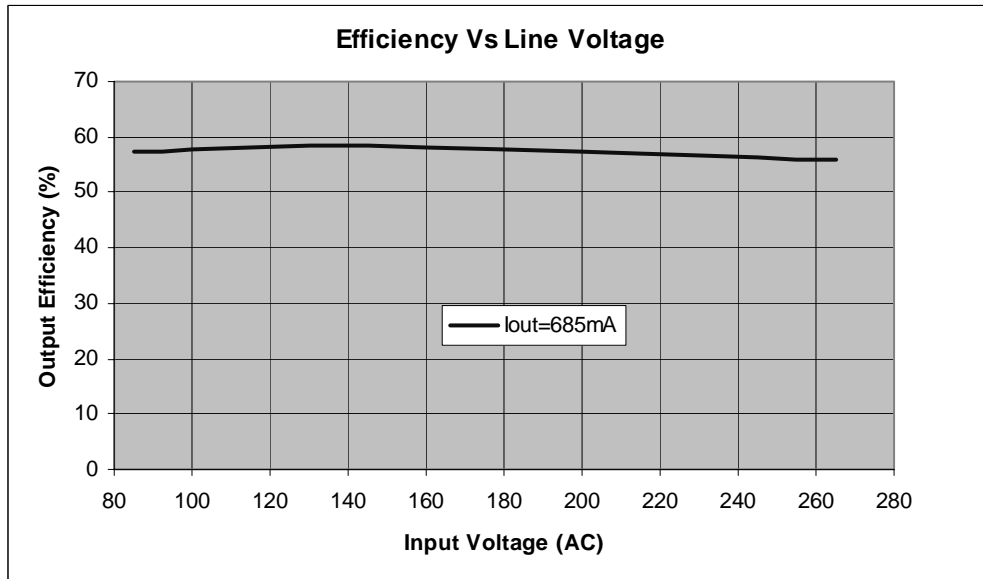

Figure 5 - Efficiency vs. input voltage



5.2.2 Efficiency vs. Output current

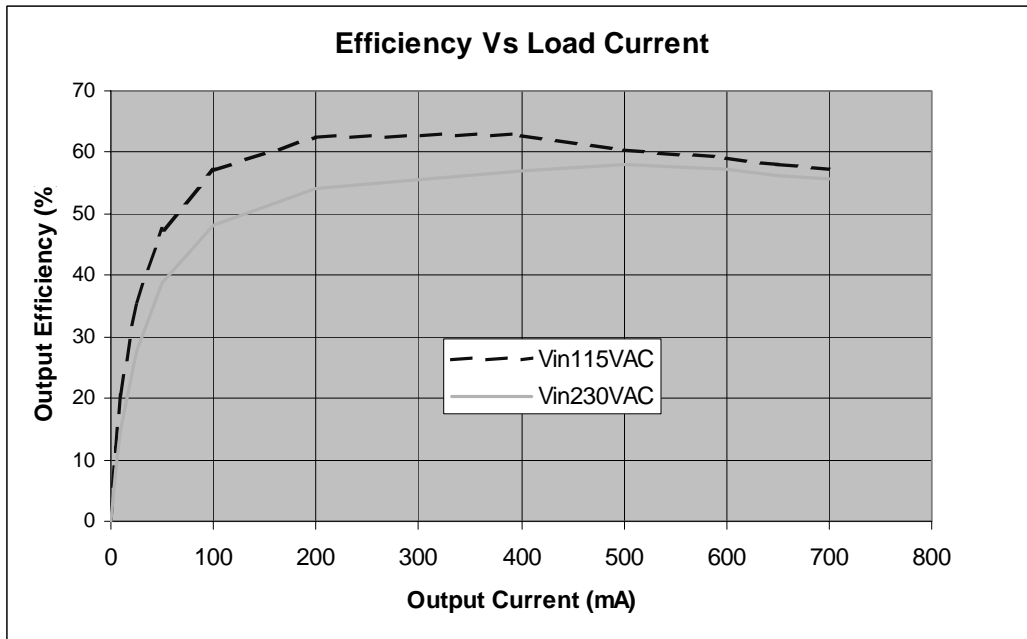

Figure 6 - Efficiency vs. output current

5.3 Output Ripple.

The output Ripple was measured in the input voltage range from 85 to 265VAC and output load current range from 0 to 640mA. The picture below shows the worst case.

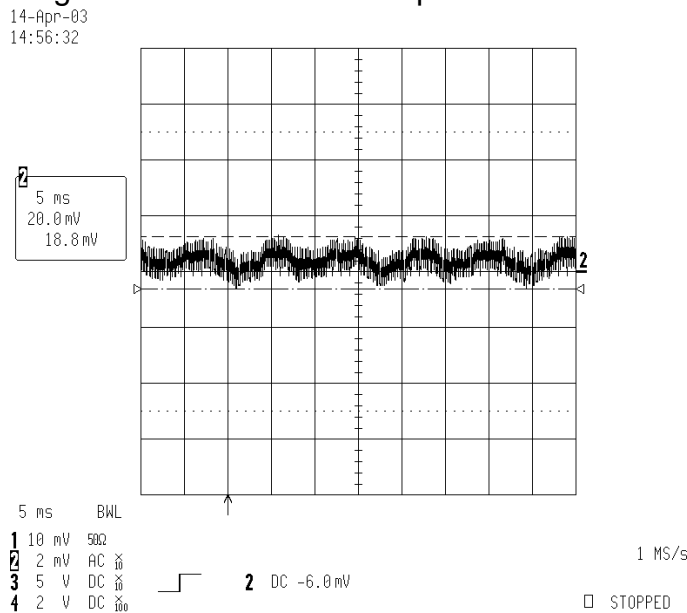

Figure 7 - Output ripple measure at Vin=85Vac, Iout=640mA



5.4 Transient Load Response

14-Apr-03
15:09:51

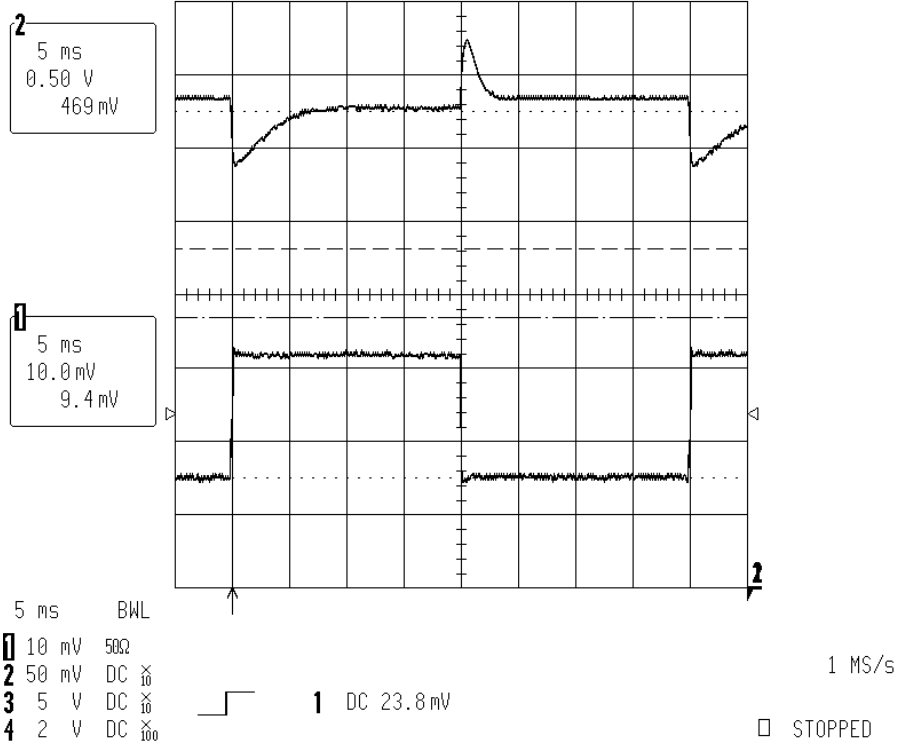

Figure 8 - Output ripple measure at Vin=85Vac, Iout step from 350mA to 685mA

5.5 No load power consumption

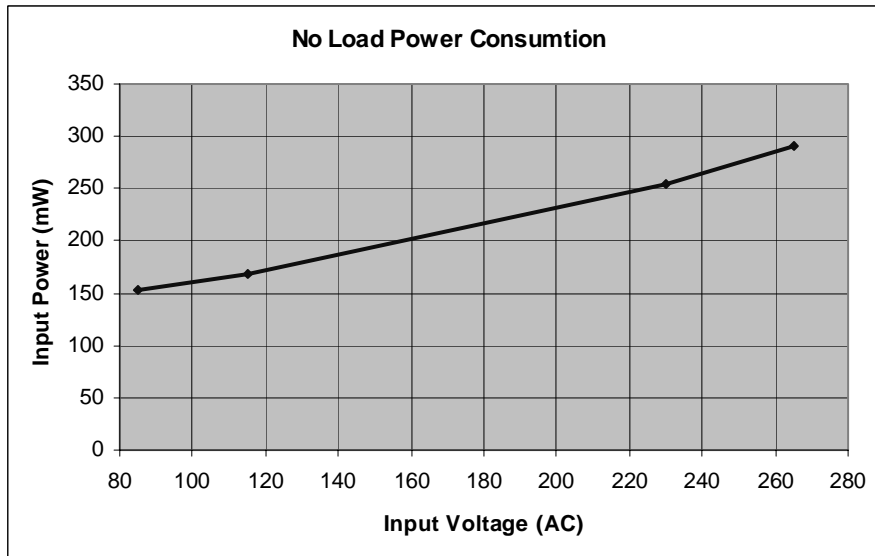

Figure 9 - No load power consumption



6 Conducted EMI Measurement

Conducted EMI was measured and compared with EN22B limits. The measured results are shown below.

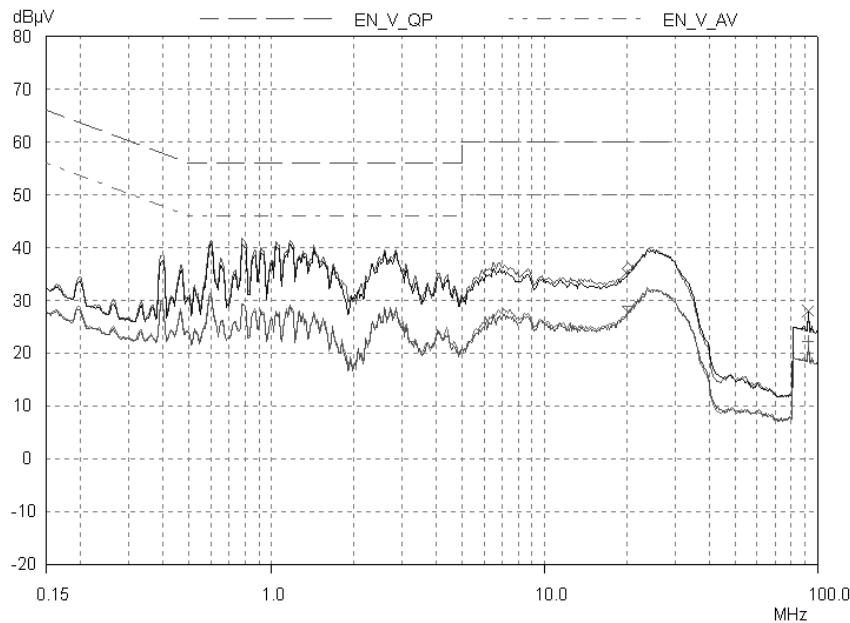

Figure 10 - Measured conducted EMI. Input 115V; output 5.1V 650mA; output return connected to the ARTIFICIAL HAND CONNECTOR of the LISN detection mode: Quasi-Peak and Average; Phase: Line and Neutral

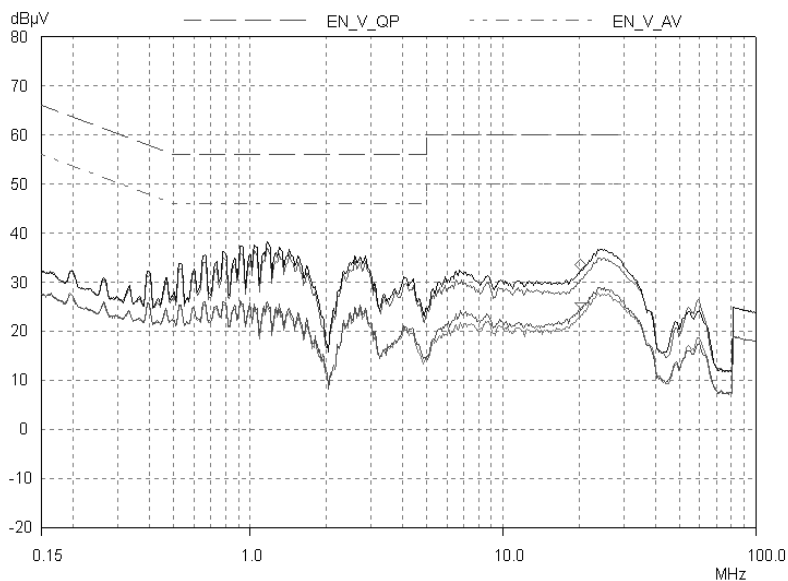

Figure 11 - Measured Conducted EMI. Input 115V; Output 5.1V 650mA; Output floating; Detection Mode: Quasi-Peak and Average; Phase: Line and Neutral



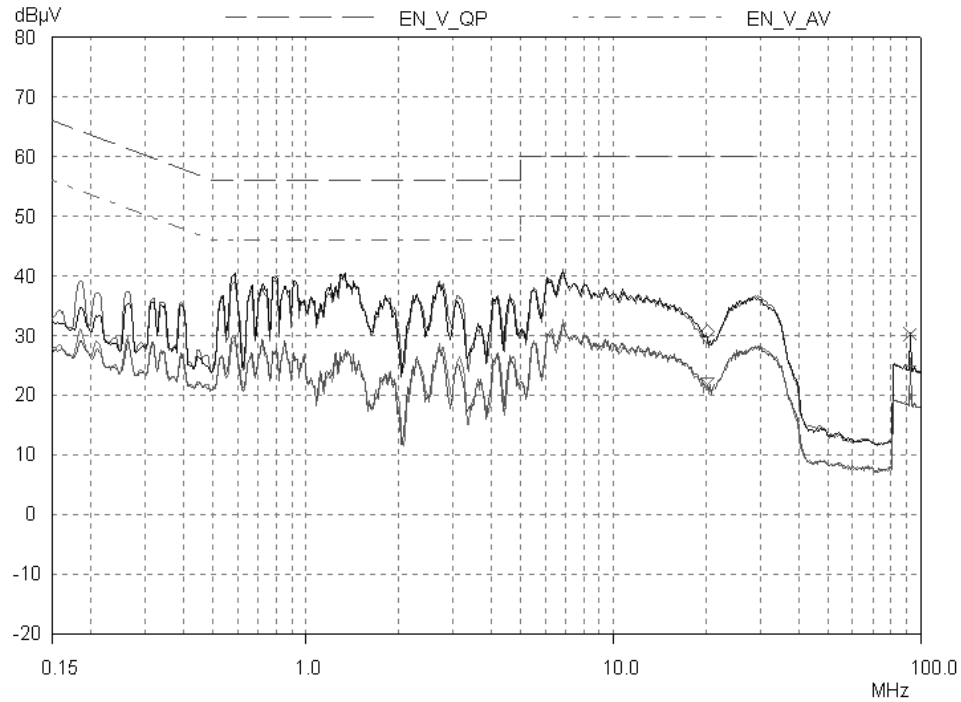

Figure 12 - Measured Conducted EMI. Input 230V; Output 5.1V 650mA; Output return connected to the ARTIFICIAL HAND CONNECTOR of the LISN Detection Mode; Quasi-Peak and Average; Phase: Line and Neutral

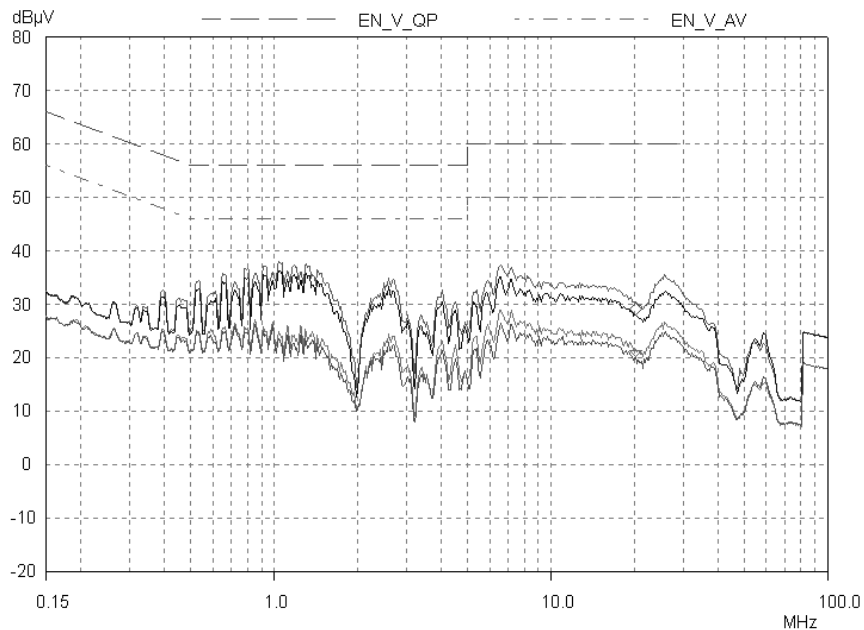

Figure 13 - Measured Conducted EMI. Input 230V; Output 5.1V 650mA; Output floating; Detection Mode: Quasi-Peak and Average; Phase: Line and Neutral



7 Transformer Design

7.1 Transformer Winding

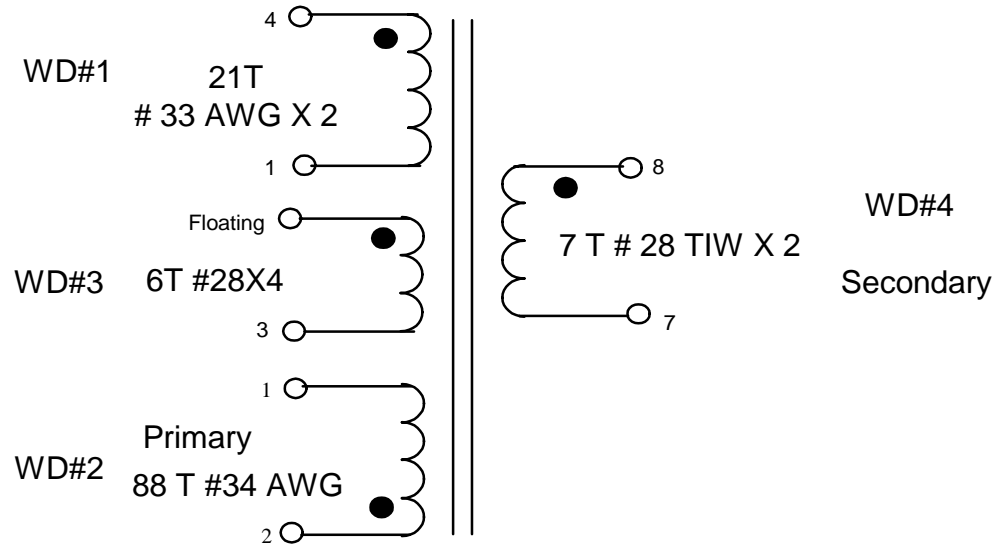

Figure 14 – Transformer Winding

7.2 Electrical Specifications

Electrical Strength	60Hz 1minute, from Pins 1-4 to Pins 7-8	3000 V ac
Primary Inductance (Pin 1 to Pin 2)	All windings open	937 uH +/- 10% at 132KHz
Resonant Frequency. (Pin 1 to Pin 2)	All windings open	950 kHz (Min.)
Primary Leakage Inductance. (Pin 1 to Pin 2)	Pins 7-8 shorted	37 uH Max.

7.3 Materials

Item	Description
[1]	Core: PC40EF16-Z, TDK or equivalent Gapped for AL of 122 nH/T ²
[2]	Bobbin: Horizontal 8 pin. Pin 5 and 6 to be removed.
[3]	Magnet Wire: #34 AWG
[4]	Magnet Wire: #33 AWG
[5]	Magnet Wire: #28 AWG
[6]	Triple Insulated Wire: #28 AWG.
[7]	Tape: 3M 1298 Polyester Film, 2.0 mils thick, 9.8 mm wide
[8]	Tinned bus wire 32 AWG
[9]	Varnish



7.4 Transformer Construction

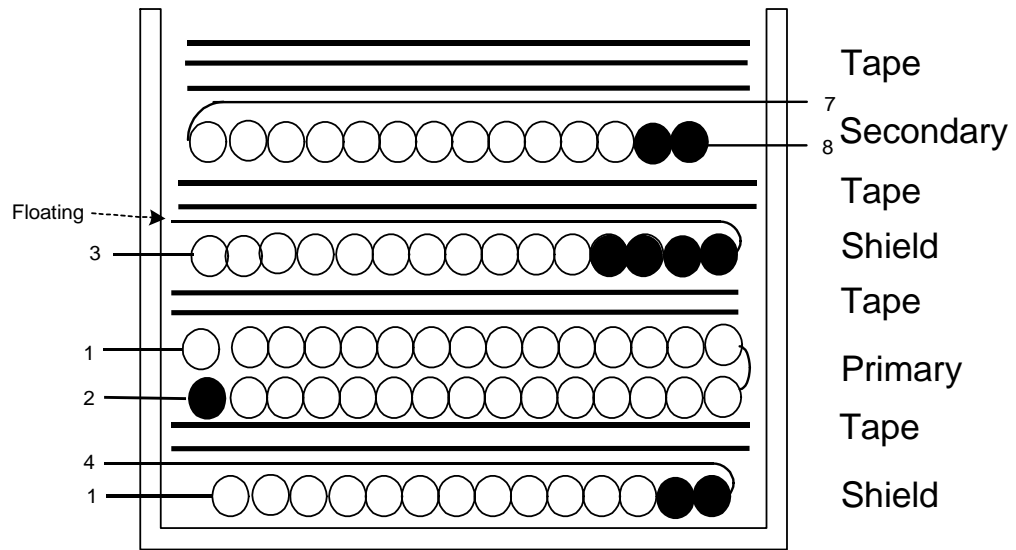

Figure 15 - Transformer construction

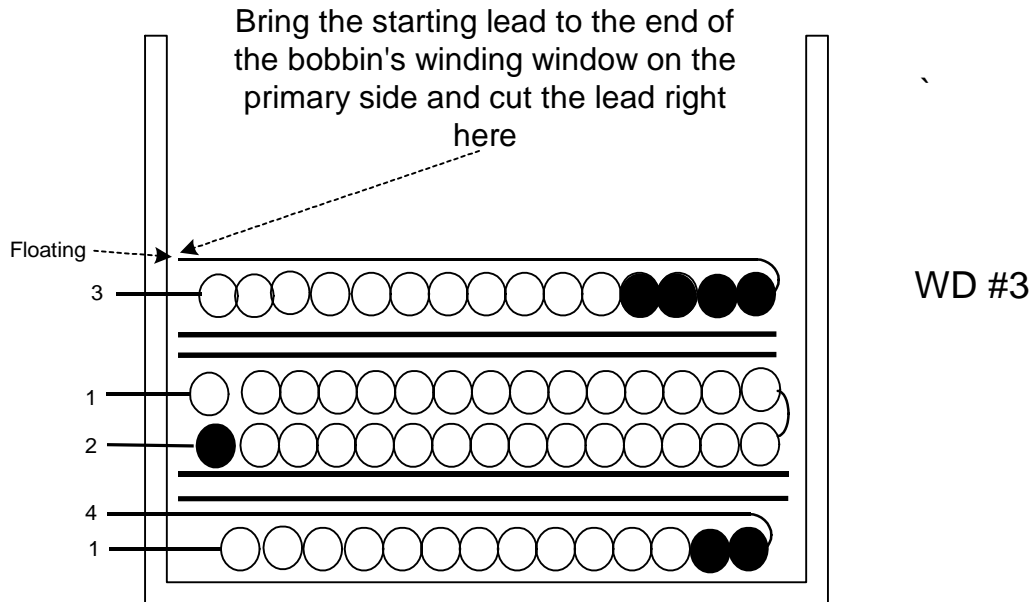

Figure 16 – Partial Transformer Winding Diagram showing the place where the starting lead of winding 3 should be cut



7.5 Winding Instructions

WD1 Shield Winding	Primary pin side of the bobbin oriented to left hand side. Start at Pin 7 temporarily. Wind 21 bifilar turns of item [4] from right to left. Wind with tight tension across entire bobbin evenly. Finish on Pin 1.
WD1	Change the start pin from pin 7 to pin 4.
Insulation	2 Layers of tape [7] for insulation.
WD#2 Primary winding	Start at pin 2 wind 44 turns of item [3] from left to right, then wind another 44 turns next layer from right to left. Wind with tight tension across entire bobbin evenly Finish at pin 1
Insulation	2 Layers of tape [7] for insulation.
WD #3 Shield Winding	Start at Pin 7 temporarily, wind 6 quadrifilar turns of item [5], wind from right to left with tight tension. Wind uniformly, in a single layer across entire width of bobbin. Finish on Pin 3.
WD #3	Cut the lead of the starting end as in shown in figure 15.
Insulation	2 Layers of tape [7] for insulation.
WD #4 Secondary Winding	Start at pin 8, wind 7 bifilar turns of item [6] from right to left. Wind uniformly, in a single layer across entire bobbin evenly. Finish on pin 7.
Outer Insulation	3 Layers of tape [7] for insulation.
Core Assembly	Assemble and secure core halves.
Core Grounding	Start at Pin 3, wind 2 turns of [8], around the core close to primary side. Finish at pin 3. Wind it tight making good contact the wire with the core.
Varnish	Varnish



8 Revision History

Date	Author	Revision	Description & changes	Reviewed
February 4, 2004	YG	1.0	Initial release	AM/VC



Notes



For the latest updates, visit our Web site: www.powerint.com

Power Integrations reserves the right to make changes to its products at any time to improve reliability or manufacturability. Power Integrations does not assume any liability arising from the use of any device or circuit described herein, nor does it convey any license under its patent rights or the rights of others.

The products and applications illustrated herein (including circuits external to the products and transformer construction) may be covered by one or more U.S. and foreign patents or potentially by pending U.S. and foreign patent applications assigned to Power Integrations. A complete list of Power Integrations' patents may be found at www.powerint.com.

The PI Logo, **TOPSwitch**, **TinySwitch**, **LinkSwitch**, and **EcoSmart** are registered trademarks of Power Integrations, Inc. **PI Expert** and **DPA-Switch** are trademarks of Power Integrations, Inc.
© Copyright 2003, Power Integrations, Inc.

WORLD HEADQUARTERS

AMERICAS

Power Integrations
5245 Hellyer Avenue
San Jose, CA 95138 USA.
Main: +1-408-414-9200
Customer Service:
Phone: +1-408-414-9665
Fax: +1-408-414-9765
E-Mail:
usasales@powerint.com

EUROPE & AFRICA

Power Integrations (Europe) Ltd.
Centennial Court
Easthampstead Road
Bracknell
Berkshire RG12 1YQ,
United Kingdom
Phone: +44-1344-462-300
Fax: +44-1344-311-732
E-Mail:
eurosales@powerint.com

SINGAPORE

Power Integrations, Singapore
51 Goldhill Plaza #16-05
Republic of Singapore 308900
Phone: +65-6358-2160
Fax: +65-6358-2015
E-Mail:
singaporesales@powerint.com

TAIWAN

Power Integrations
International Holdings, Inc.
17F-3, No. 510,
Chung Hsiao E. Rd., Sec. 5,
Taipei, Taiwan 110, R.O.C.
Phone: +886-2-2727-1221
Fax: +886-2-2727-1223
E-Mail:
taiwansales@powerint.com

CHINA

Power Integrations
International Holdings, Inc.
Rm# 1705, Bao Hua Bldg.
1016 Hua Qiang Bei Lu
Shenzhen Guangdong,
518031, China
Phone: +86-755-8367-5143
Fax: +86-755-8377-9610
E-Mail:
chinasales@powerint.com

KOREA

Power Integrations
International Holdings, Inc.
Rm# 402, Handuk Building,
649-4 Yeoksam-Dong, Kangnam-
Gu
Seoul, Korea
Phone: +82-2-568-7520
Fax: +82-2-568-7474
E-Mail:
koreasales@powerint.com

JAPAN

Power Integrations, K.K.
Keihin-Tatemono 1st Bldg.
12-20 Shin-Yokohama
2-Chome,
Kohoku-ku, Yokohama-shi,
Kanagawa 222-0033, Japan
Phone: +81-45-471-1021
Fax: +81-45-471-3717
E-Mail:
Japansales@powerint.com

INDIA (Technical Support)

Innovatech
#1, 8th Main Road
Vasanthnagar
Bangalore, India 560052
Phone: +91-80-226-6023
Fax: +91-80-228-9727
E-Mail:
indiasales@powerint.com

APPLICATIONS HOTLINE

World Wide +1-408-414-9660

APPLICATIONS FAX

World Wide +1-408-414-9760

