

NPN Silicon Darlington Transistors

BC 875
... BC 879

- High current gain
- Low collector-emitter saturation voltage
- Complementary types: BC 876, BC 878
BC 880 (PNP)

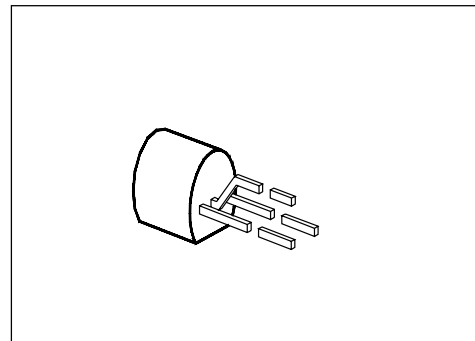

Type	Marking	Ordering Code	Pin Configuration			Package ¹⁾
			1	2	3	
BC 875 BC 877 BC 879	–	C62702-C853 C62702-C854 C62702-C855	E	C	B	TO-92

Maximum Ratings

Parameter	Symbol	Values			Unit
		BC 875	BC 877	BC 879	
Collector-emitter voltage	V_{CE0}	45	60	80	V
Collector-base voltage	V_{CB0}	60	80	100	
Emitter-base voltage	V_{EB0}	5			
Collector current	I_C	1			A
Peak collector current	I_{CM}	2			
Base current	I_B	100			mA
Peak base current	I_{BM}	200			
Total power dissipation, $T_C = 90\text{ °C}^2)$	P_{tot}	0.8 (1)			W
Junction temperature	T_j	150			°C
Storage temperature range	T_{stg}	– 65 ... + 150			

Thermal Resistance

Junction - ambient ²⁾	$R_{th\ JA}$	≤ 156	K/W
Junction - case ³⁾	$R_{th\ JC}$	≤ 75	

1) For detailed information see chapter Package Outlines.

2) If transistors with max. 4 mm lead length are fixed on PCBs with a min. 10 mm × 10 mm large copper area for the collector terminal, $R_{thJA} = 125\text{ K/W}$ and thus $P_{tot\ max} = 1\text{ W}$ at $T_A = 25\text{ °C}$.

3) Mounted on Al heat sink 15 mm × 25 mm × 0.5 mm.

Electrical Characteristics

at $T_A = 25\text{ °C}$, unless otherwise specified.

Parameter	Symbol	Values			Unit
		min.	typ.	max.	

DC characteristics

Collector-emitter breakdown voltage $I_C = 50\text{ mA}$	$V_{(BR)CE0}$				V
BC 875		45	–	–	
BC 877		60	–	–	
BC 879		80	–	–	
Collector-base breakdown voltage $I_C = 100\text{ }\mu\text{A}$	$V_{(BR)CB0}$				
BC 875		60	–	–	
BC 877		80	–	–	
BC 879		100	–	–	
Emitter-base breakdown voltage, $I_E = 100\text{ }\mu\text{A}$	$V_{(BR)EB0}$	5	–	–	
Collector cutoff current $V_{CE} = 0.5 \times V_{CEmax}$	I_{CE0}	–	–	500	nA
Collector cutoff current $V_{CB} = V_{CBmax}$ $V_{CB} = V_{CBmax}$, $T_A = 150\text{ °C}$	I_{CB0}	–	–	100 20	nA μA
Emitter cutoff current, $V_{EB} = 4\text{ V}$	I_{EB0}	–	–	100	nA
DC current gain $I_C = 150\text{ mA}$; $V_{CE} = 10\text{ V}^{1)}$ $I_C = 500\text{ mA}$; $V_{CE} = 10\text{ V}^{1)}$	h_{FE}	1000 2000	– –	– –	–
Collector-emitter saturation voltage ¹⁾ $I_C = 500\text{ mA}$, $I_B = 0.5\text{ mA}$ $I_C = 1\text{ A}$, $I_B = 1\text{ mA}$	V_{CEsat}	– –	– –	1.3 1.8	V
Base-emitter saturation voltage ¹⁾ $I_C = 1\text{ A}$; $I_B = 1\text{ mA}$	V_{BEsat}	–	–	2.2	

AC characteristics

Transition frequency $I_C = 200\text{ mA}$, $V_{CE} = 5\text{ V}$, $f = 20\text{ MHz}$	f_T	–	150	–	MHz
---	-------	---	-----	---	-----

¹⁾ Pulse test: $t \leq 300\text{ }\mu\text{s}$, $D \leq 2\%$.

Total power dissipation $P_{tot} = f(T_A; T_C)$

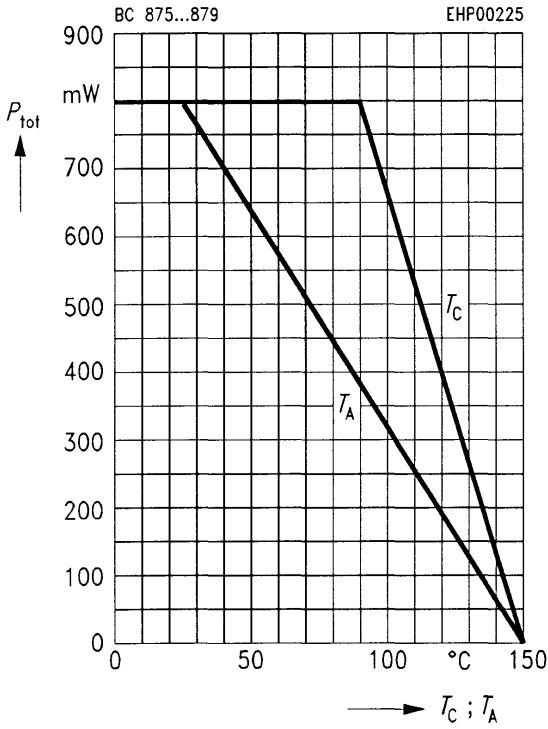

Collector cutoff current $I_{CB0} = f(T_A)$

$V_{CB} = 100\text{ V}$

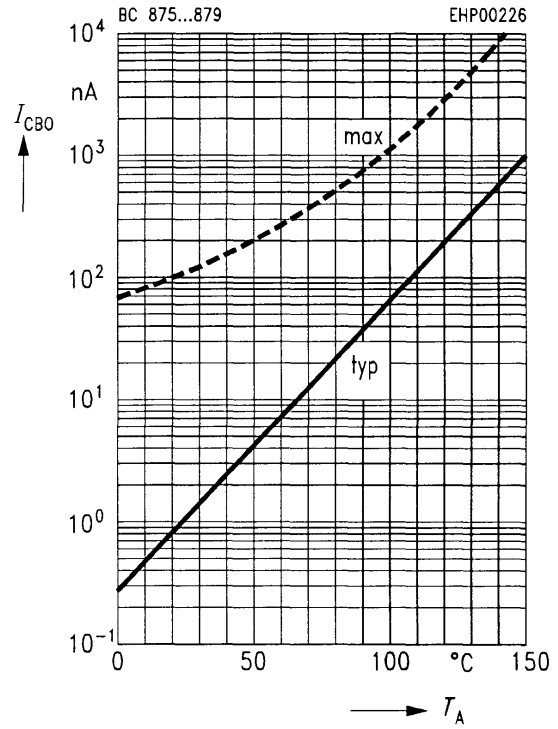

Permissible pulse load $R_{thJA} = f(t_p)$

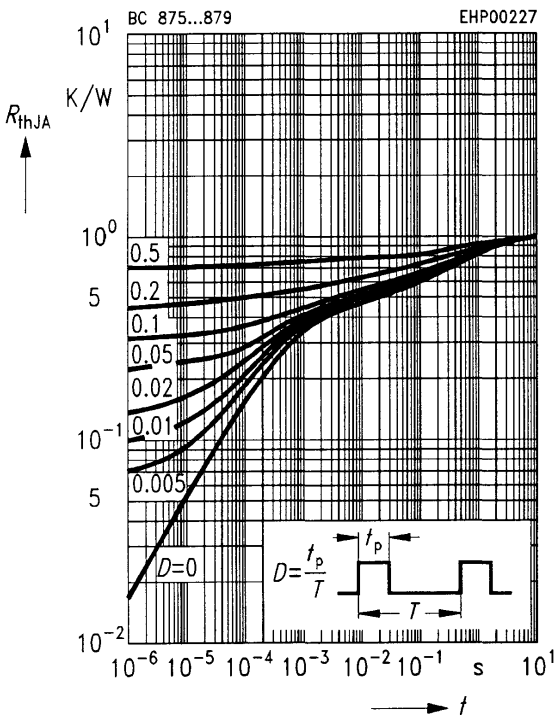

DC current gain $h_{FE} = f(T_A)$

$V_{CE} = 10\text{ V}$

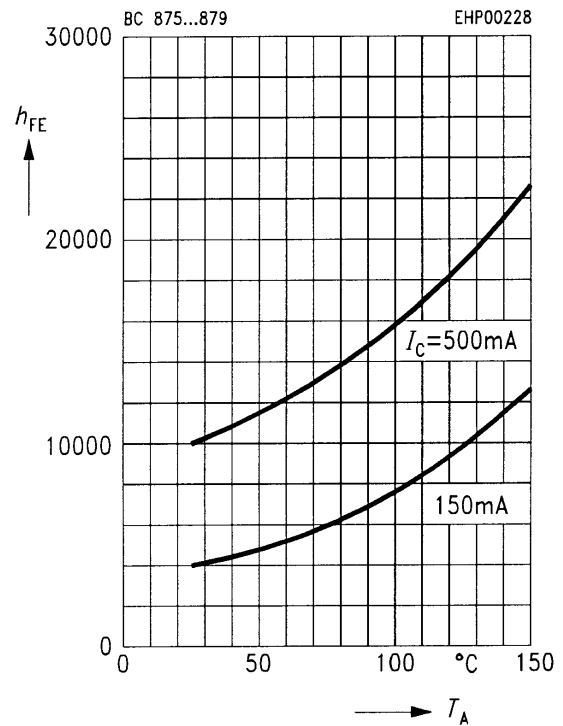

DC current gain $h_{FE} = f(I_C)$

$V_{CE} = 10\text{ V}, T_A = 25\text{ }^\circ\text{C}$

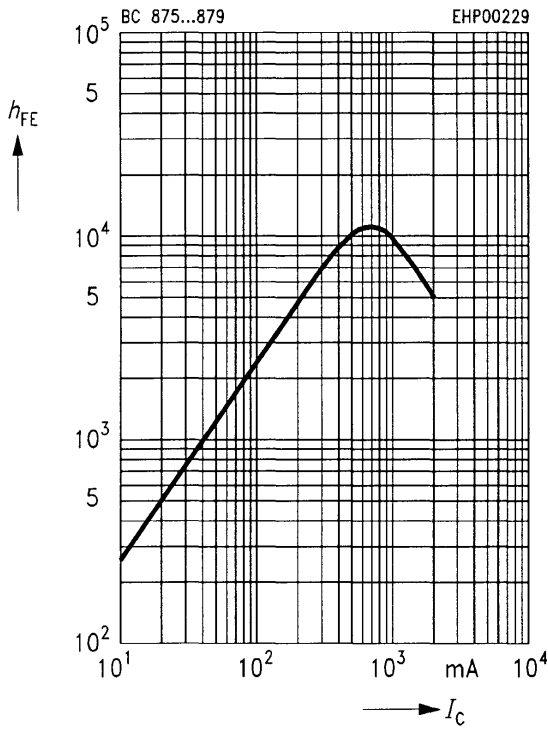

Transition frequency $f_T = f(I_C)$

$V_{CE} = 5\text{ V}, f = 20\text{ MHz}$

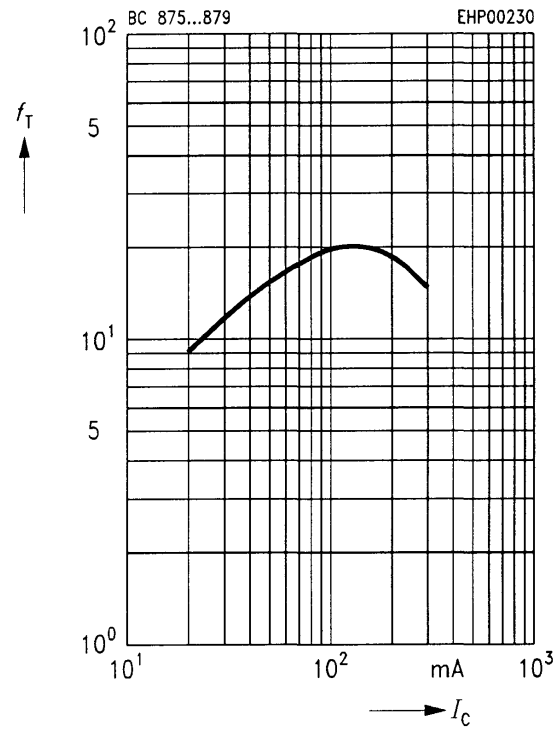

Collector-emitter saturation voltage

$V_{CEsat} = f(I_C)$

Parameter = $I_B, T_A = 25\text{ }^\circ\text{C}$

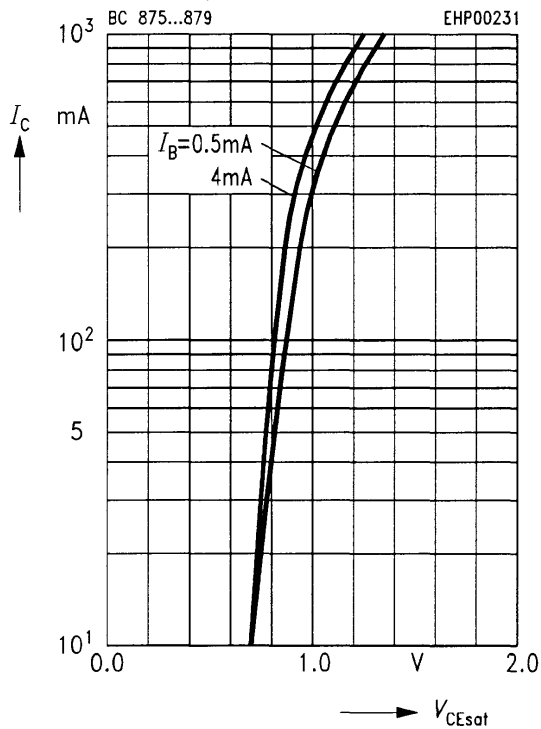

Base-emitter saturation voltage

$V_{BEsat} = f(I_C)$

Parameter = $I_B, T_A = 25\text{ }^\circ\text{C}$

