

## SPECIFICATION

- Electrical Rating: 16A 125V AC (Resistive Load)  
10A 250V AC (Resistive Load)  
16A 250V AC (Resistive Load)
- Operating Temp: 50 ~ 175°C (UL.CUL 205°C)
- Differential: 10~30K (15K Standard)
- Temp. Tolerance: Operating Temp.  $\pm 3K$   $\pm 5K$  Heat Durability: 220°C Max. (PPS)
- Circuit Resistance: 50mΩ Max.
- Insulation Resistance: 100MΩ Min. at DC500V
- Dielectric Strength AC 1000V for One Minute. or AC 1800V for One Second.
- Operating Life: 100000 Cycles (16A 125V/10A 250V AC)  
10000 Cycles (16A 250V AC)



## HOW TO ORDER

### MODEL CODE (FULL CODE)

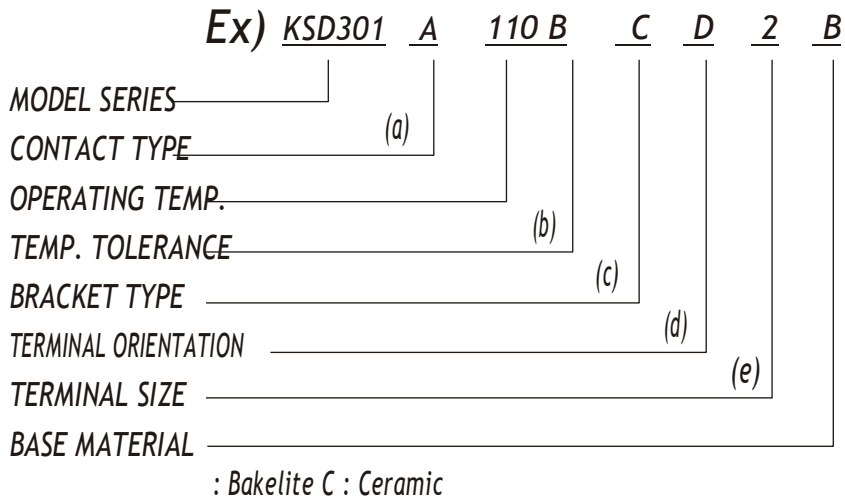

### (a) CONTACT TYPE :

A = Contact Opens When Temperature Rises to Set Point (Normally Closed)



B = Contact Closes When Temperature Rises to Set Point (Normally Open)



M = Manual Reset

### (b) TEMP. TOLERANCE :

(\*=STANDARD)

Grade	A	*B
Action $\pm$ °C	3	5
Reset $\pm$ °C	4	8

- The Grade of Temp. Tolerance is "A", When The Operating Temp. is Less Than 105°C.

- The Grade of Temp. Tolerance is "B", When The Operating Temp. is Over 106°C.

**(c) BRACKET TYPE :**

● **FIXED BRACKET**

\* STAINLESS STEEL CAP : D,DL,V,T TYPE

SCREW TYPE : M4x0.7 L:6mm (STD)  
M5x0.8 L:6mm (STD)  
#6-32UNC  
#8-32UNC

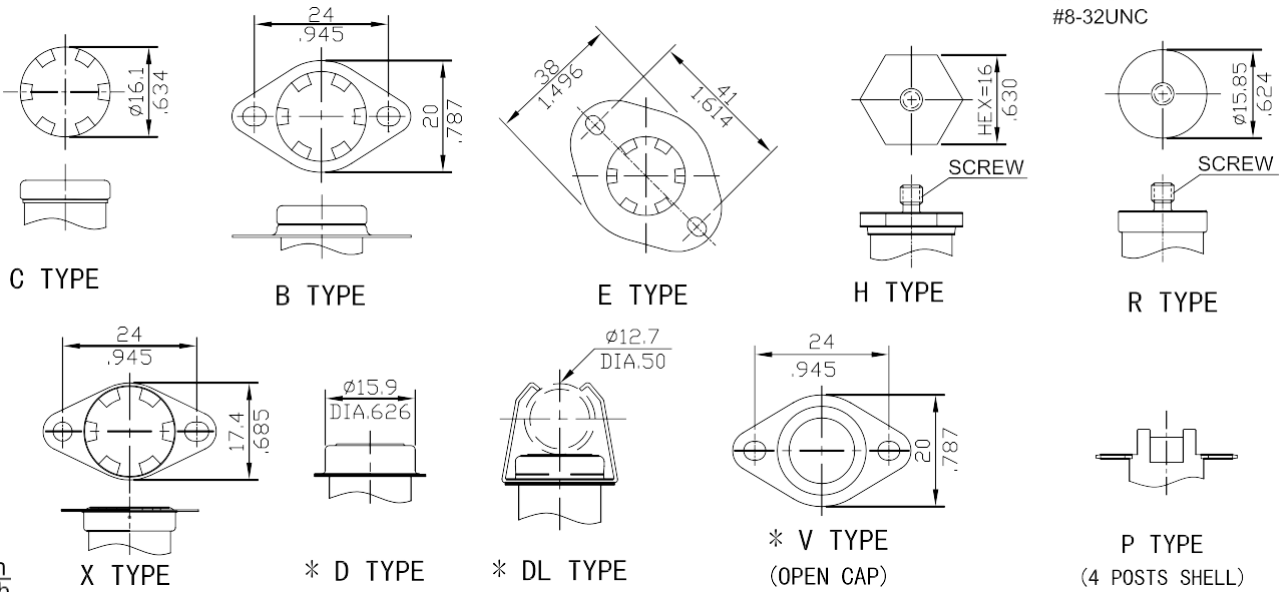

● **LOOSE BRACKET**

\* STAINLESS STEEL CAP : U TYPE

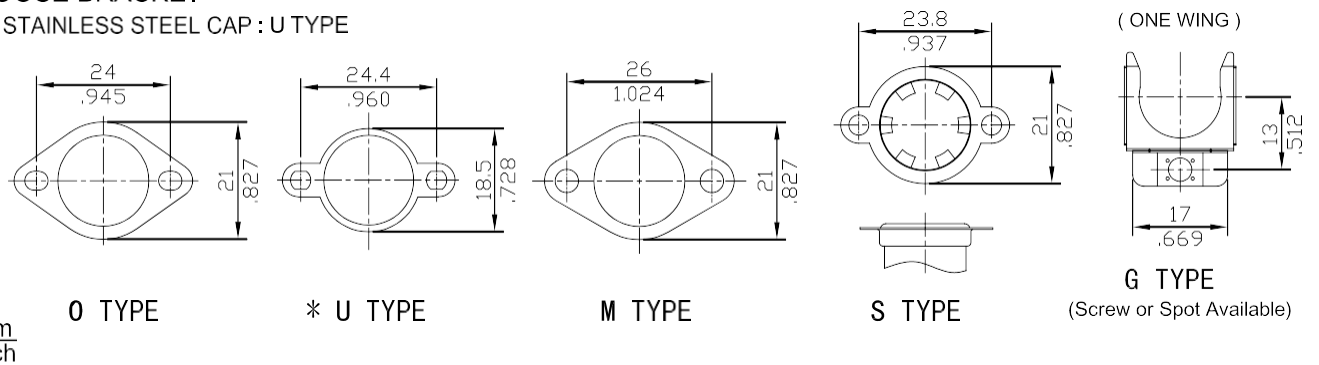

**(d) TERMINAL ORIENTATION:**

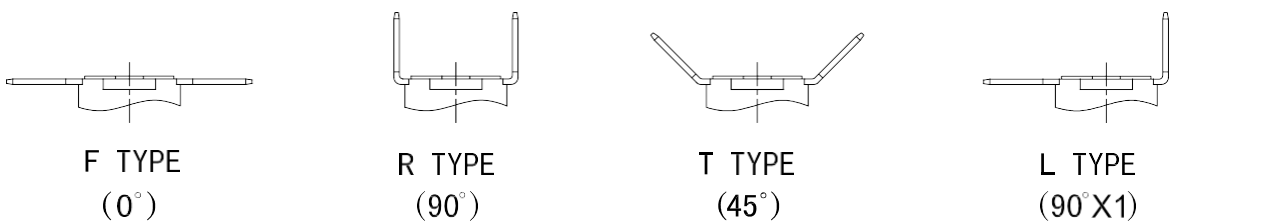

**(e) TERMINAL SIZE:**

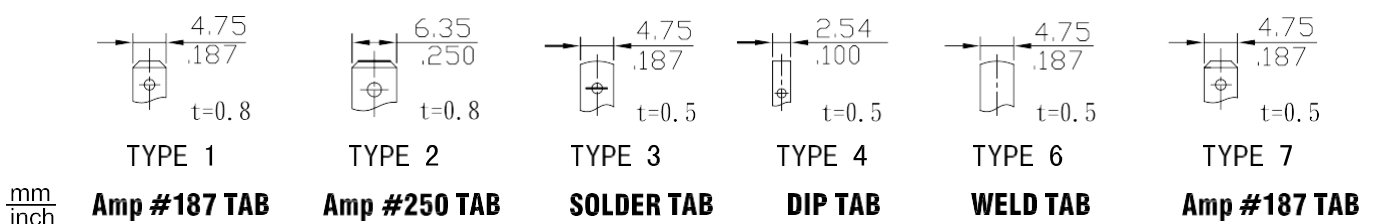

**KSD301A-CF2**

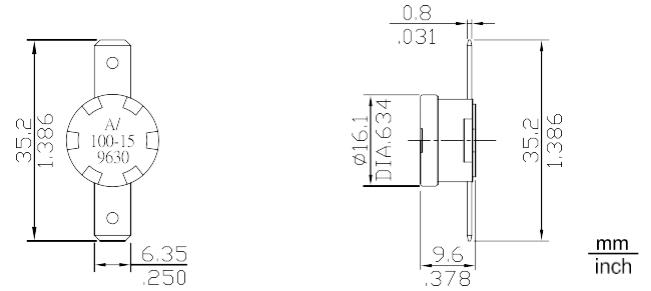

**KSD301A-CR1-OS(ONE SHOT)**

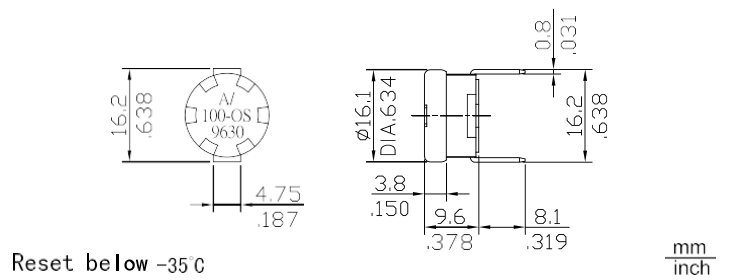

**KSD301A-SF2(LOOSE BRACKET)**

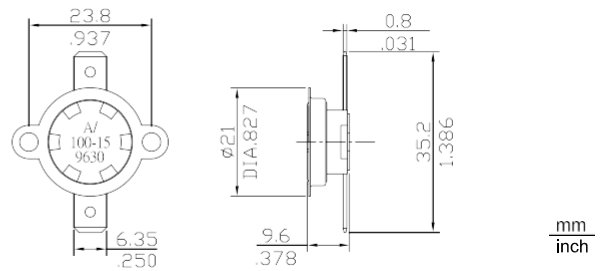

**KSD301A-PF2(4-POST)**

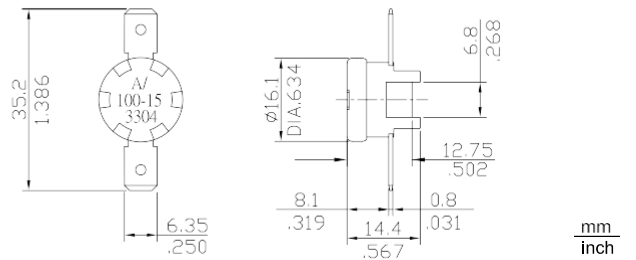

**KSD301A-XF2(FIX BRACKET)**

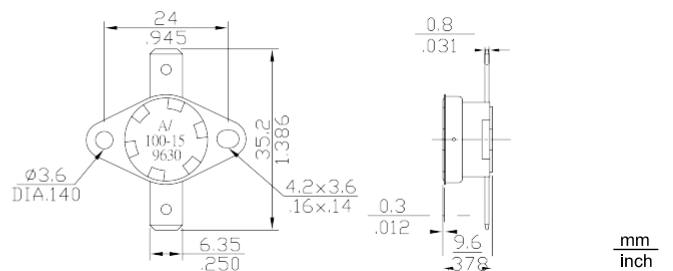

# Thermostat KSD301



## KSD301M-RF2

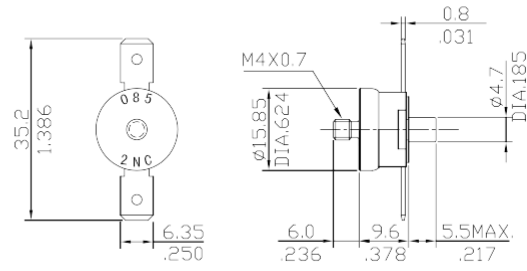

mm  
inch

## KSD301A-HF1

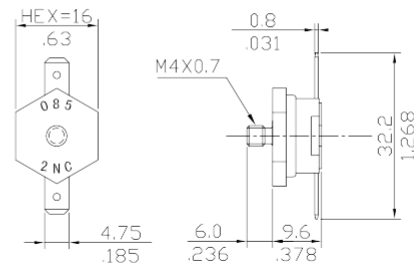

mm  
inch

## KSD301A-HR1

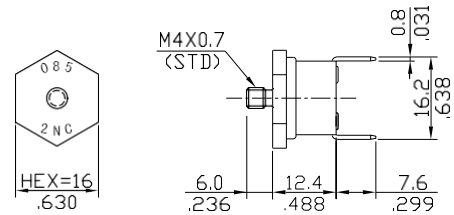

mm  
inch

## KSD301A-RF2-A

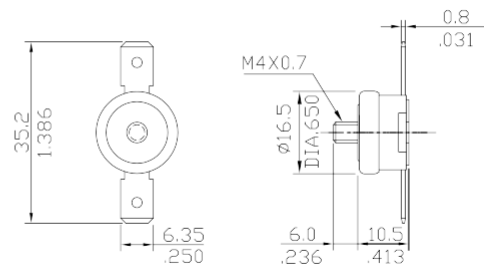

mm  
inch

## KSD301A-RF2-A

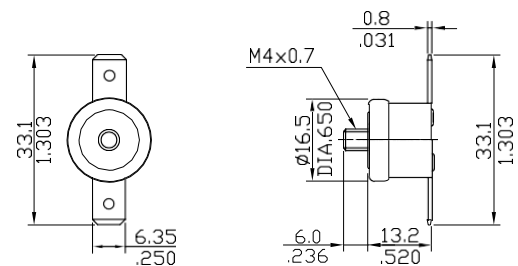

mm  
inch

**KSD301A-BF2**

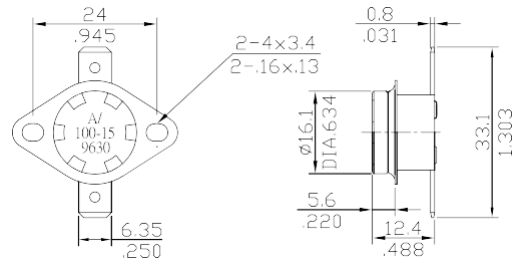

mm  
inch

**KSD301B-CF2**

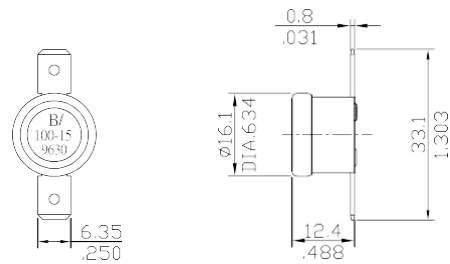

mm  
inch

**KSD301M-DF2**

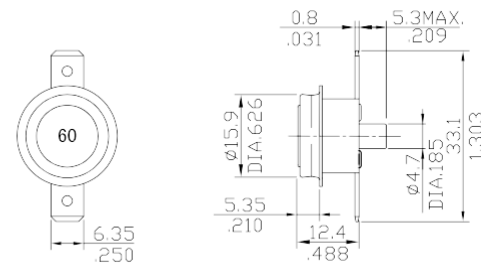

mm  
inch

**KSD301A-CR4**



(FOR PCB)

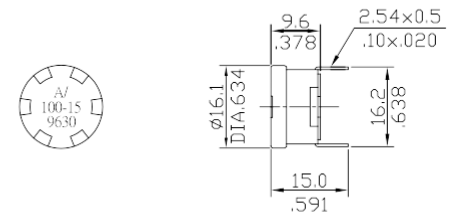

mm  
inch

**KSD301A-DR2-E**

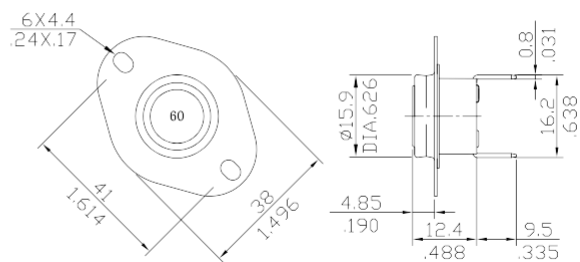

mm  
inch

**KSD301A-SF2-U**

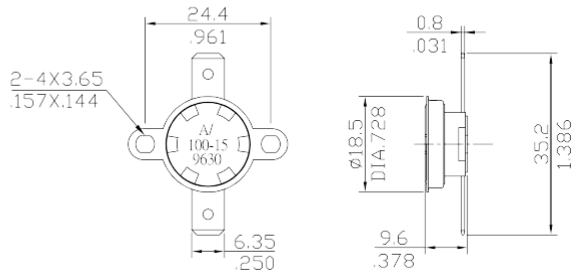

mm  
inch

**KSD301A-SF2(LOOSE BRACKET)**

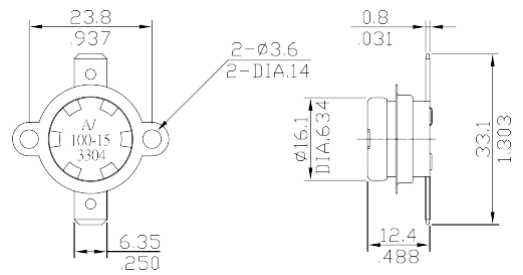

mm  
inch

**KSD301A-XF1(FIX BRACKET)**

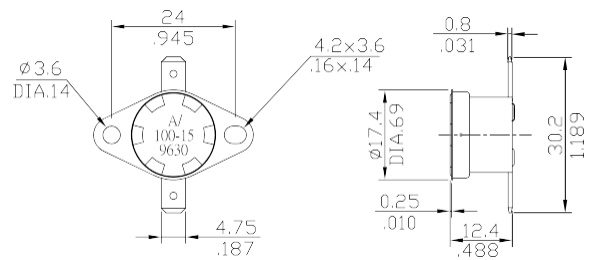

mm  
inch

**KSD301A-BF2-V(OPEN CAP)**

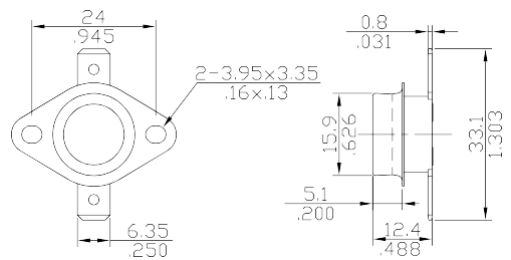

mm  
inch