

**Silicon PNP Power Transistors**

**2SA1209**

**DESCRIPTION**

- With TO-126 package
- Complement to type 2SC2911
- High breakdown voltage
- Fast switching speed

**APPLICATIONS**

- High-voltage switching and AF 100W predriver applications

**PINNING**

PIN	DESCRIPTION
1	Emitter
2	Collector;connected to mounting base
3	Base

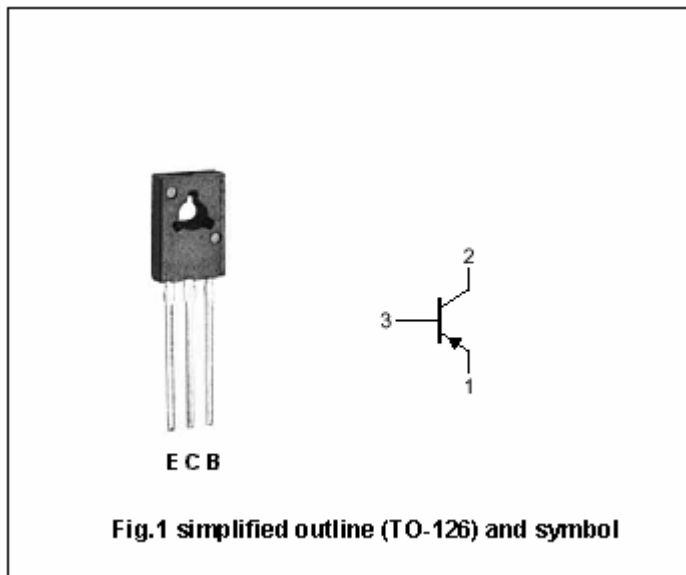

**Absolute maximum ratings(Ta=25°C)**

SYMBOL	PARAMETER	CONDITIONS	VALUE	UNIT
V <sub>CBO</sub>	Collector-base voltage	Open emitter	-180	V
V <sub>CEO</sub>	Collector-emitter voltage	Open base	-160	V
V <sub>EBO</sub>	Emitter-base voltage	Open collector	-5	V
I <sub>C</sub>	Collector current		-0.14	A
I <sub>CM</sub>	Collector current-Peak		-0.20	A
P <sub>C</sub>	Collector power dissipation	T <sub>a</sub> =25°C	1.0	W
		T <sub>C</sub> =25°C	10	
T <sub>j</sub>	Junction temperature		150	°C
T <sub>stg</sub>	Storage temperature		-55~150	°C

## Silicon PNP Power Transistors

## 2SA1209

## CHARACTERISTICS

T<sub>j</sub>=25°C unless otherwise specified

SYMBOL	PARAMETER	CONDITIONS	MIN	TYP.	MAX	UNIT
V <sub>CEsat</sub>	Collector-emitter saturation voltage	I <sub>C</sub> =-50mA; I <sub>B</sub> =-5mA			-0.4	V
I <sub>CB0</sub>	Collector cut-off current	V <sub>CB</sub> =-80V; I <sub>E</sub> =0			-0.1	μA
I <sub>EBO</sub>	Emitter cut-off current	V <sub>EB</sub> =-4V; I <sub>C</sub> =0			-0.1	μA
h <sub>FE</sub>	DC current gain	I <sub>C</sub> =-10mA; V <sub>CE</sub> =-5V	100		400	
f <sub>T</sub>	Transition frequency	I <sub>C</sub> =-10mA; V <sub>CE</sub> =-10V		150		MHz
C <sub>ob</sub>	Output capacitance	I <sub>E</sub> =0; V <sub>CB</sub> =-10V; f=1MHz		4.0		pF

Switching times resistive load

t <sub>on</sub>	Turn-on time	I <sub>C</sub> =10mA I <sub>B1</sub> =-I <sub>B2</sub> =1mA		0.1		μs
t <sub>s</sub>	Storage time			1.5		μs
t <sub>f</sub>	Fall time			0.1		μs

◆ h<sub>FE</sub> Classifications

R	S	T
100-200	140-280	200-400

Silicon PNP Power Transistors

2SA1209

PACKAGE OUTLINE

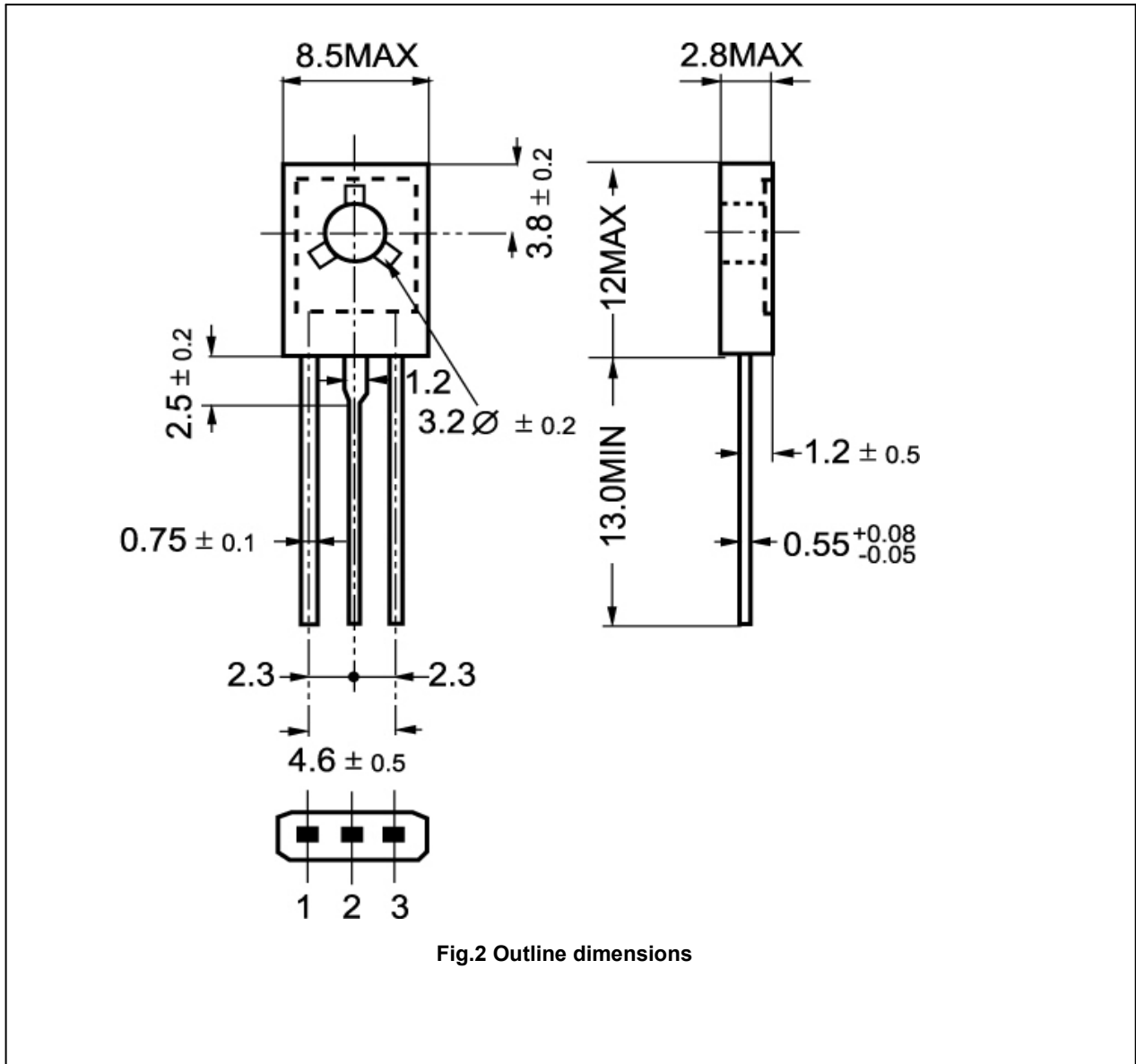

Silicon PNP Power Transistors

2SA1209

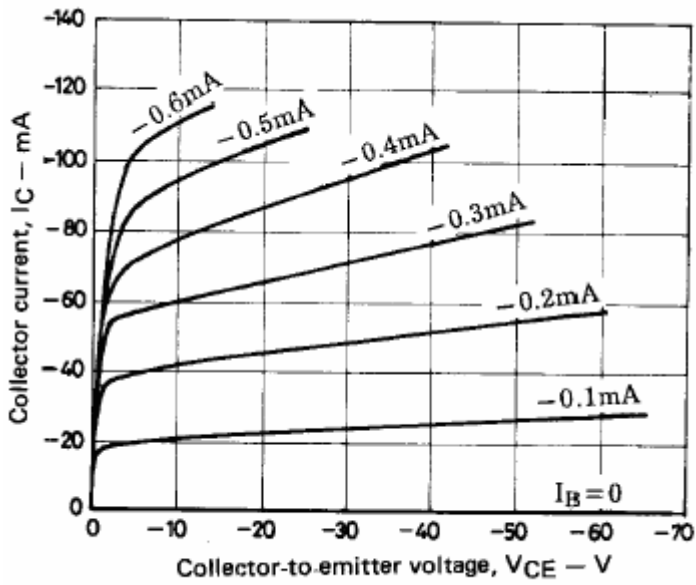

Fig.3 Static Characteristic

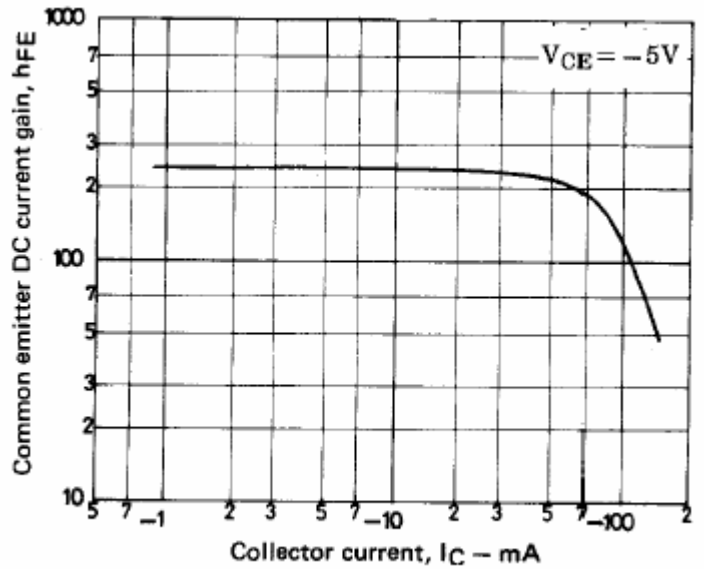

Fig.4 DC current Gain

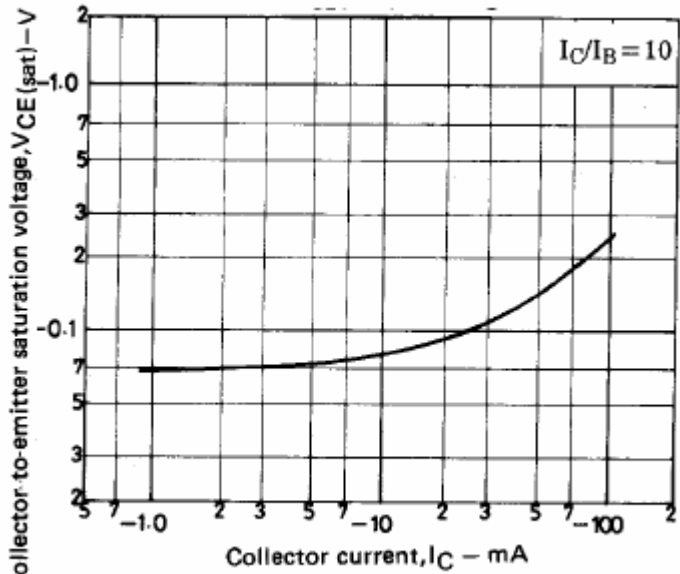

Fig.5 Collector-Emitter Saturation Voltage

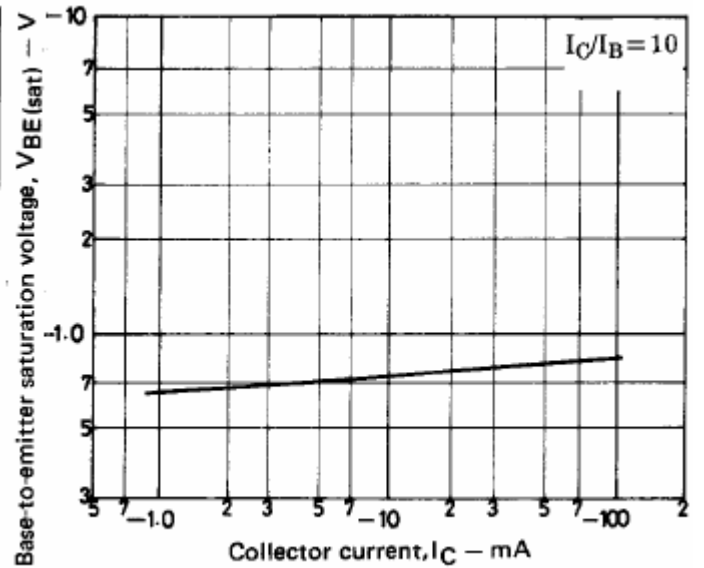

Fig.6 Base-Emitter Saturation Voltage

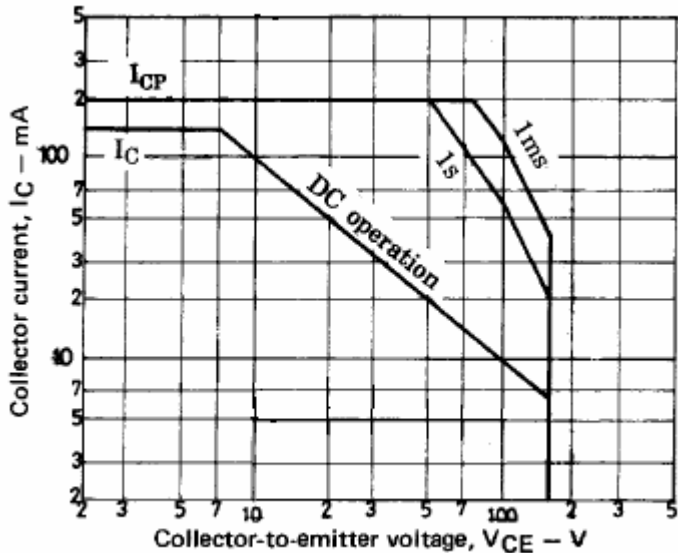

Fig.7 Safe Operating Area