

Silicon PNP Power Transistors

2SA1302

DESCRIPTION

- With TO-3PL package
- Complement to type 2SC3281

APPLICATIONS

- Power amplifier applications
- Recommended for 100W high fidelity audio frequency amplifier output stage

PINNING

PIN	DESCRIPTION
1	Emitter
2	Collector;connected to mounting base
3	Base

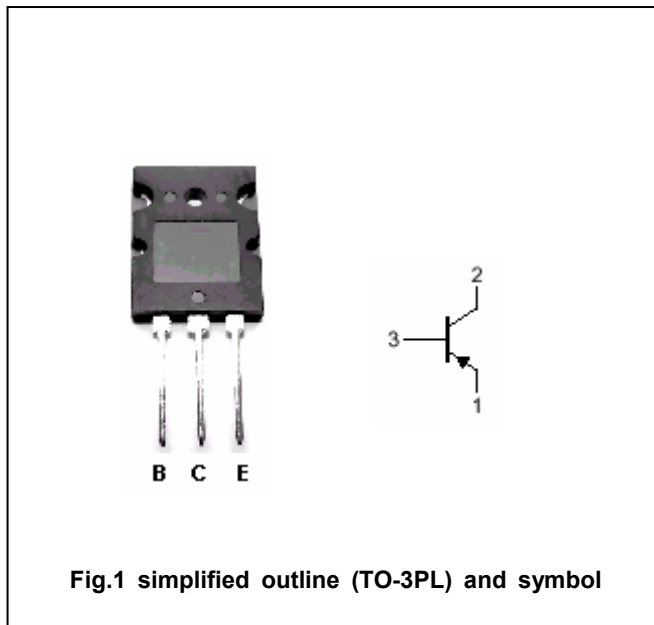

Fig.1 simplified outline (TO-3PL) and symbol

Absolute maximum ratings(Ta=25°C)

SYMBOL	PARAMETER	CONDITIONS	VALUE	UNIT
V _{CB0}	Collector-base voltage	Open emitter	-200	V
V _{CEO}	Collector-emitter voltage	Open base	-200	V
V _{EBO}	Emitter-base voltage	Open collector	-5	V
I _C	Collector current		-15	A
I _B	Base current		-1.5	A
P _C	Collector power dissipation	T _C =25°C	150	W
T _j	Junction temperature		150	°C
T _{stg}	Storage temperature		-55~150	°C

Silicon PNP Power Transistors

2SA1302

CHARACTERISTICS

T_j=25°C unless otherwise specified

SYMBOL	PARAMETER	CONDITIONS	MIN	TYP.	MAX	UNIT
V _{(BR)CEO}	Collector-emitter breakdown voltage	I _C =-50mA ; I _B =0	-200			V
V _{CEsat}	Collector-emitter saturation voltage	I _C =-8A; I _B =-0.8A			-2.5	V
V _{BE}	Base-emitter voltage	I _C =-8A ; V _{CE} =-5V			-1.5	V
I _{CBO}	Collector cut-off current	V _{CB} =-200V; I _E =0			-5	μA
I _{EBO}	Emitter cut-off current	V _{EB} =-5V; I _C =0			-5	μA
h _{FE-1}	DC current gain	I _C =-1A ; V _{CE} =-5V	55		160	
h _{FE-2}	DC current gain	I _C =-8A ; V _{CE} =-5V	35			
f _T	Transition frequency	I _C =-1A ; V _{CE} =-5V		25		MHz
C _{OB}	Collector output capacitance	I _E =0;f=1MHz;V _{CB} =-10V		470		pF

◆ h_{FE-1} classifications

R	O
55-110	80-160

Silicon PNP Power Transistors

2SA1302

PACKAGE OUTLINE

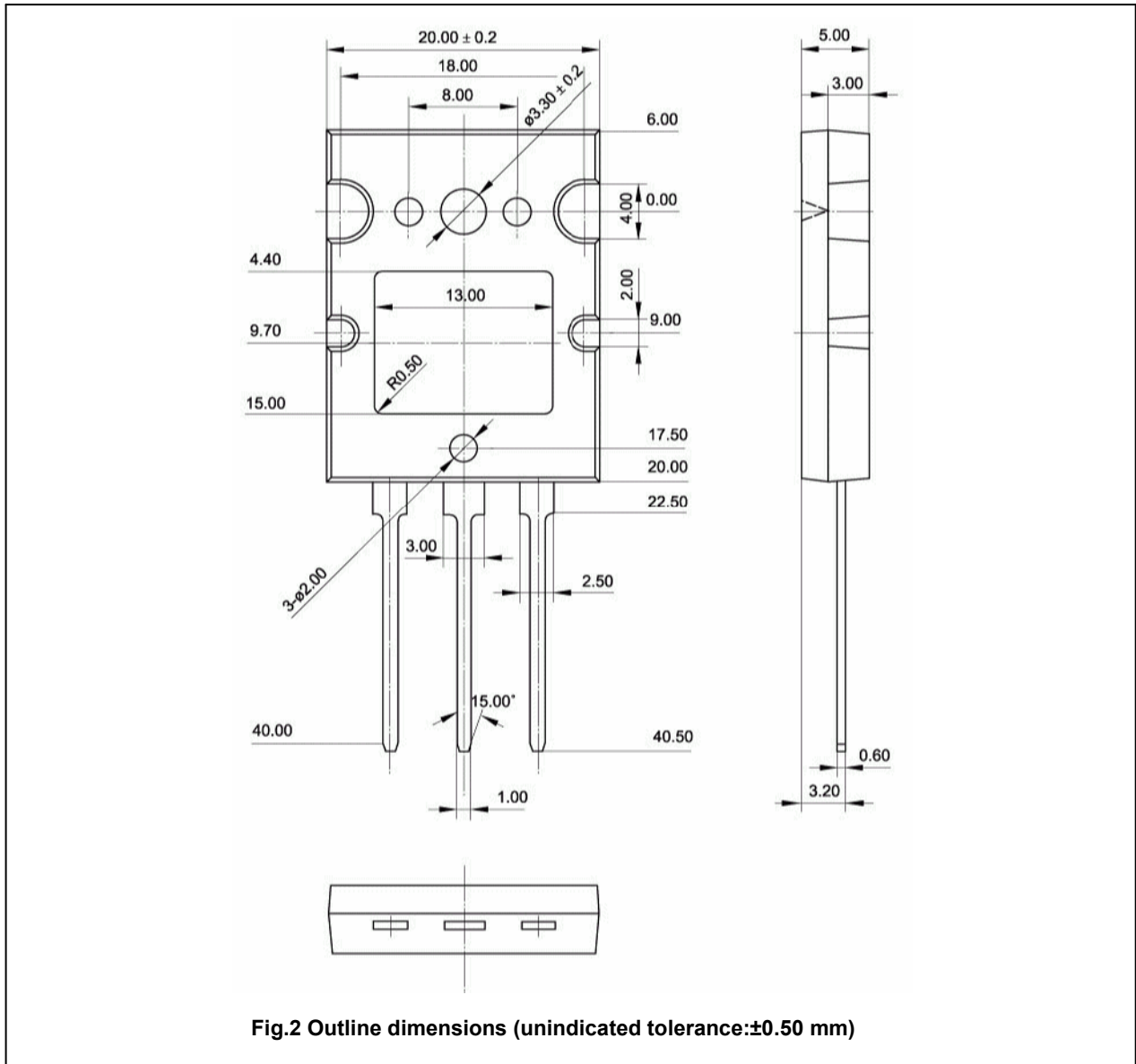

Silicon PNP Power Transistors

2SA1302

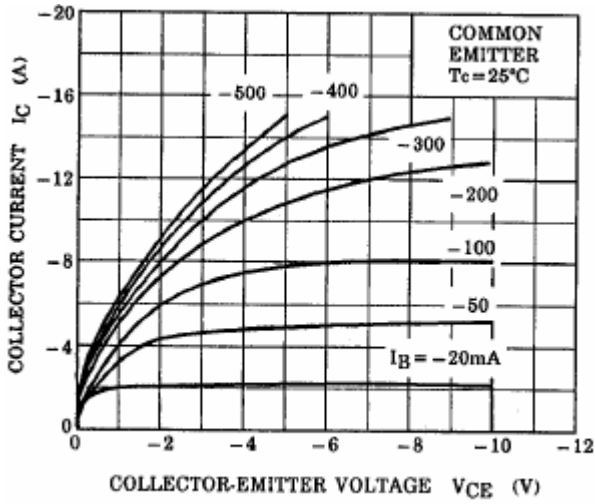

Fig.3 Static Characteristic

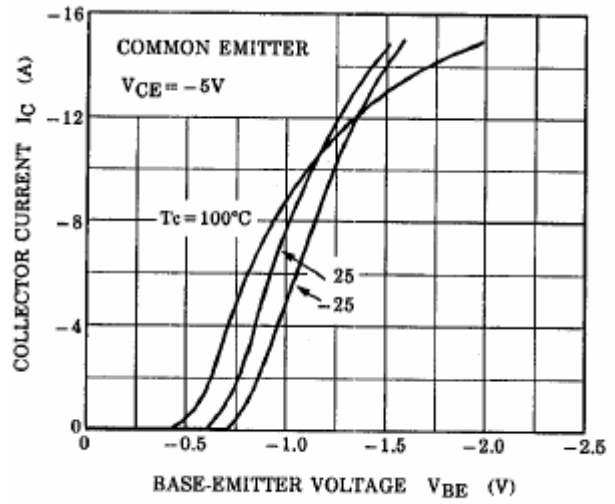

Fig.3 Base-Emitter On Voltage

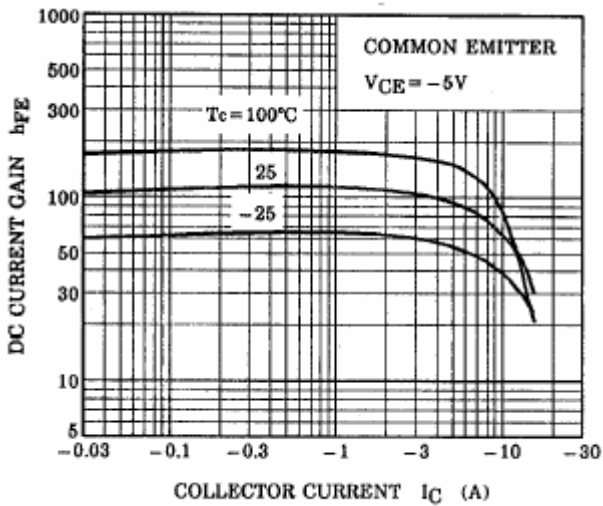

Fig.5 DC current Gain

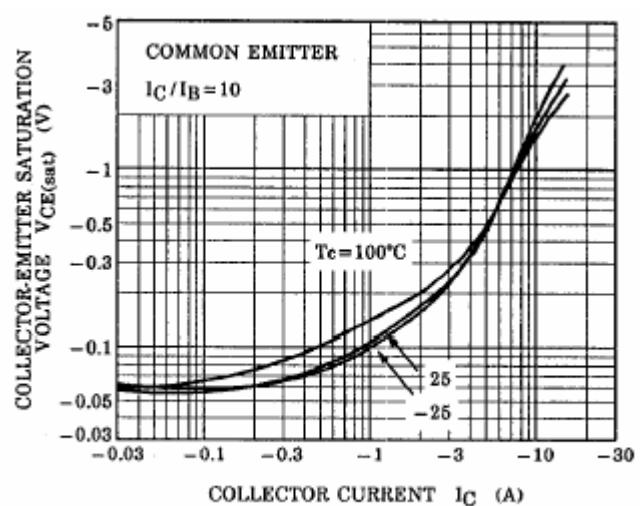

Fig.6 Collector-Emitter Saturation Voltage

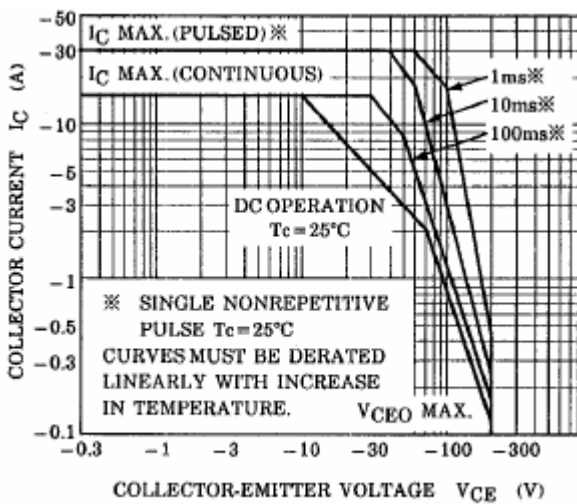

Fig.7 Safe Operating Area