

Silicon NPN Power Transistors

2SC2922

DESCRIPTION

- With MT-200 package
- Complement to type 2SA1216

APPLICATIONS

- Audio and general purpose

PINNING(see Fig.2)

PIN	DESCRIPTION
1	Base
2	Collector;connected to mounting base
3	Emitter

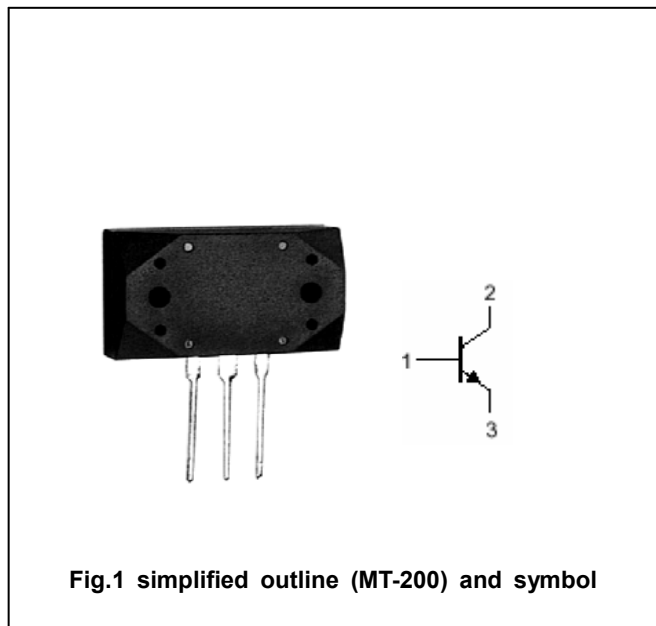

Fig.1 simplified outline (MT-200) and symbol

Absolute maximum ratings(Ta=25□)

SYMBOL	PARAMETER	CONDITIONS	VALUE	UNIT
V_{CBO}	Collector-base voltage	Open emitter	180	V
V_{CEO}	Collector-emitter voltage	Open base	180	V
V_{EBO}	Emitter-base voltage	Open collector	5	V
I_C	Collector current		17	A
I_B	Base current		5	A
P_C	Collector power dissipation	$T_C=25□$	200	W
T_j	Junction temperature		150	□
T_{stg}	Storage temperature		-55~150	□

Silicon NPN Power Transistors

2SC2922

CHARACTERISTICS

T_j=25 °C unless otherwise specified

SYMBOL	PARAMETER	CONDITIONS	MIN	TYP.	MAX	UNIT
V _{(BR)CEO}	Collector-emitter breakdown voltage	I _C =25mA ; I _B =0	180			V
V _{CEsat}	Collector-emitter saturation voltage	I _C =8A I _B =0.8A			2.0	V
I _{CBO}	Collector cut-off current	V _{CB} =180V; I _E =0			100	μA
I _{EBO}	Emitter cut-off current	V _{EB} =5V; I _C =0			100	μA
h _{FE}	DC current gain	I _C =8A ; V _{CE} =4V	30			
C _{ob}	Output capacitance	I _E =0 ; V _{CB} =10V;f=1MHz		250		pF
f _T	Transition frequency	I _C =2A ; V _{CE} =12V		50		MHz

Switching times

t _{on}	Turn-on time	I _C =10A;R _L =4Ω I _{B1} =- I _{B2} =1A V _{CC} =40V		0.20		μs
t _s	Storage time			1.30		μs
t _f	Fall time			0.45		μs

◆ h_{FE} classifications

O	Y	P	G
30-60	50-100	70-140	90-180

Silicon NPN Power Transistors

2SC2922

PACKAGE OUTLINE

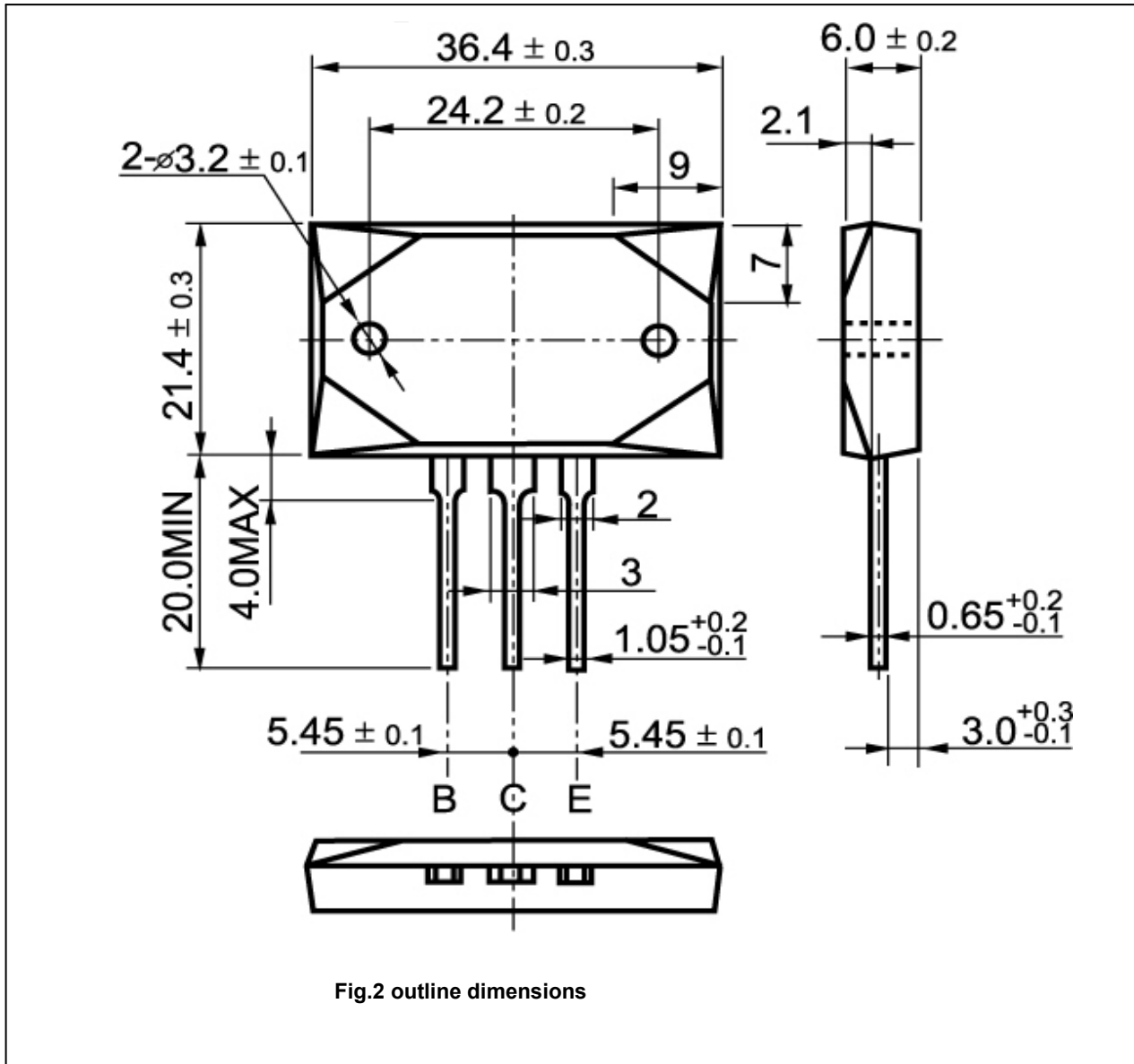

Fig.2 outline dimensions

Silicon NPN Power Transistors

2SC2922

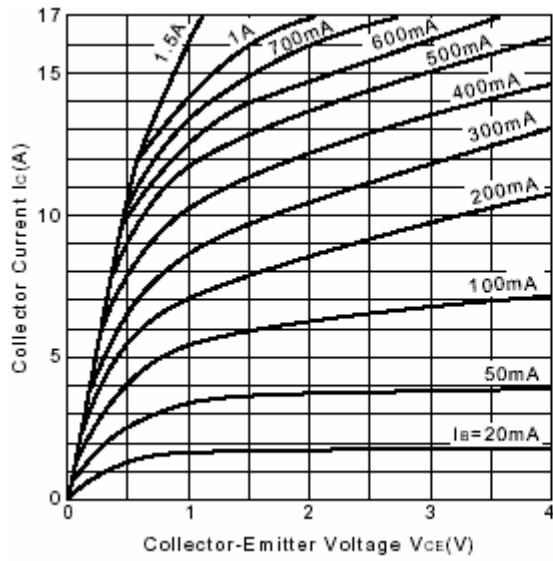

Fig.3 Static Characteristic

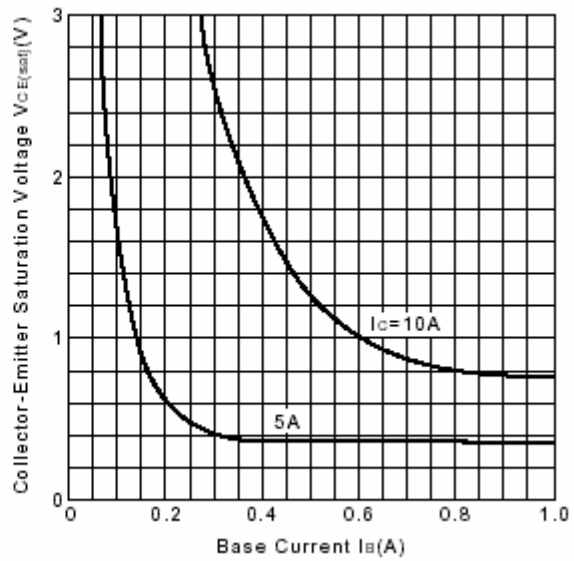

Fig.4 $V_{CE(sat)}-I_B$

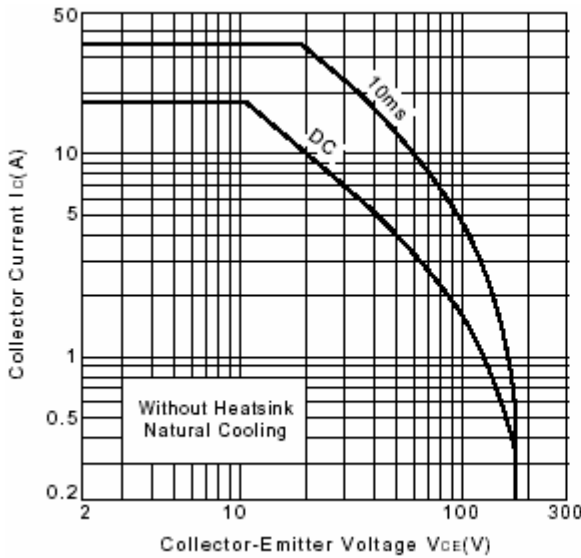

Fig.5 Safe Operating Area

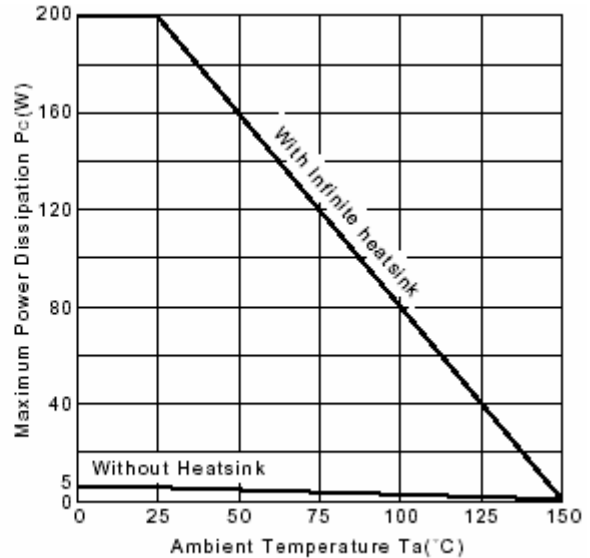

Fig.6 Power Derating

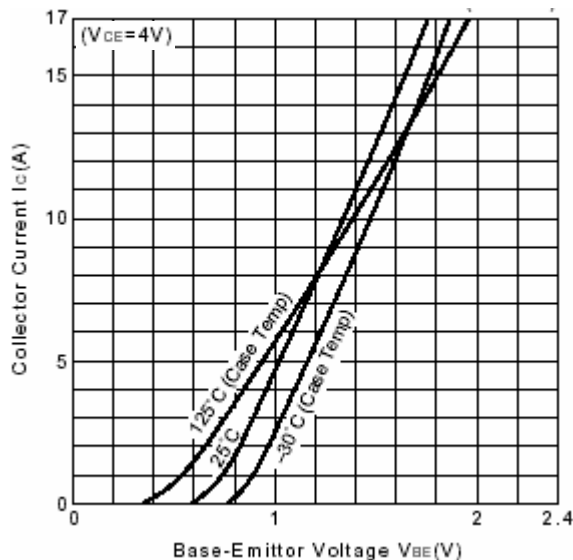

Fig.7 I_C-V_{BE}

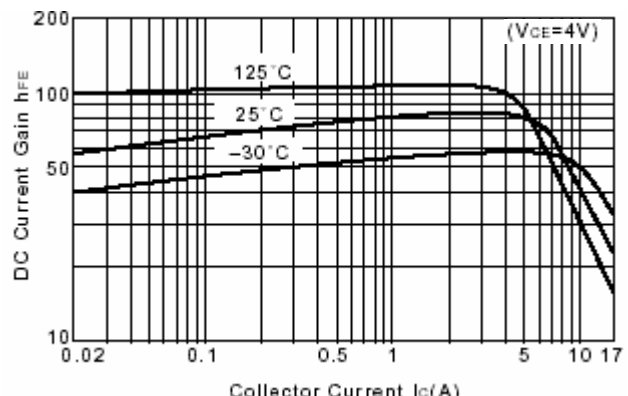

Fig.8 DC current Gain