

CASE OUTLINE DRAWINGS

D



CASE A

CBR1 Series
CBR2 Series



CASE B

CBR1-L Series
CBR2-L Series



CASE C

CBR3-P Series



CASE D

CBR4-L Series



CASE E

CBR8 Series



CASE F

CBR10 Series, CBR25 Series
CBR12 Series, CBR30 Series

All Dimensions in Inches (Millimeters)

Drawings Not To Scale

f

CASE OUTLINE DRAWINGS

T-33-31
T-33-33

D

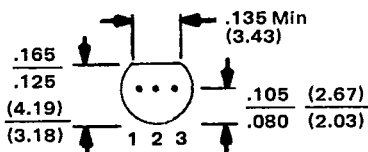
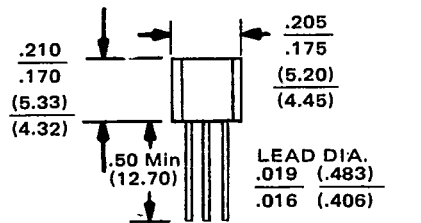

To-92(ECB)

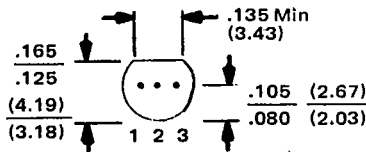
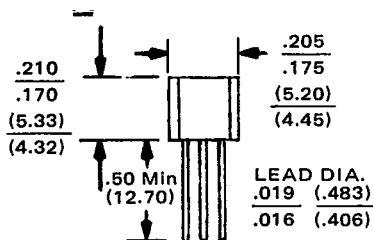

To-92(EBC)

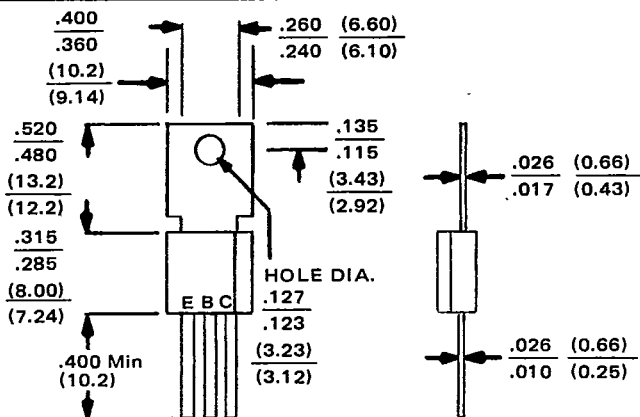

LEAD CENTERS SPACED
.105 (2.67)
.095 (2.41)

LEAD WIDTH
.055 (1.41)
.045 (1.14)

To-202

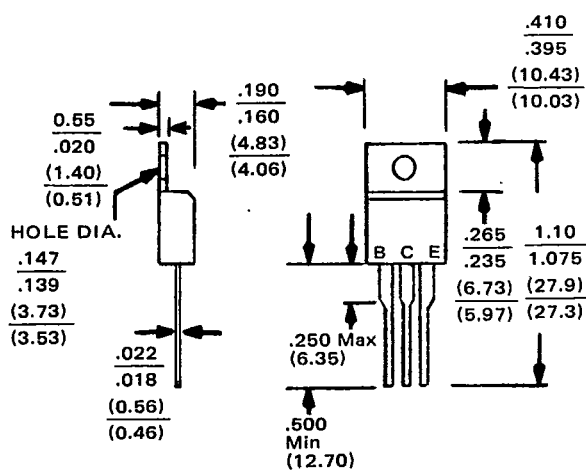

LEAD CENTERS SPACED
.105 (2.67)
.095 (2.41)

LEAD WIDTH
.032 (0.81)

To-220AB

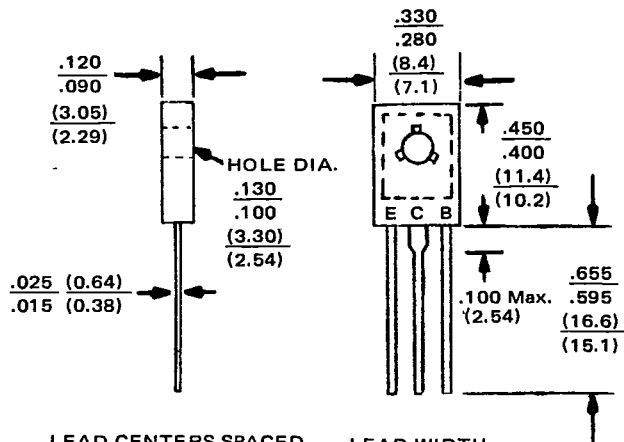

LEAD CENTERS SPACED
.100 (2.54)
.080 (2.03)

LEAD WIDTH
.035 (0.89)
.025 (0.64)

To-126

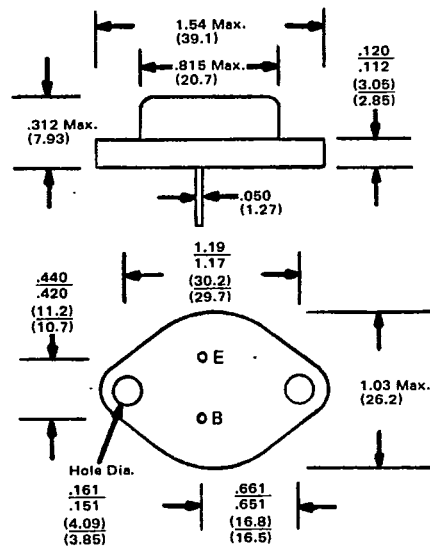

To-3

