

TBA 120T TBA 120U

FM IF AMPLIFIER AND DEMODULATOR

The TBA120T and TBA120U are symmetrical 8-stage limiting amplifiers with symmetrical coincidence demodulator and remote DC volume control. The circuits are especially suitable for the sound IF section of TV receivers and for FM/IF amplification/demodulation in FM radio receivers. An additional audio output is provided at constant level (before the volume control) for the

connection of video recorders and headphones, together with an audio input for video recorder playback.

The audio output voltage is at constant level with supply voltages between 10 and 18V and is of the same level as the TBA120S operating from a 15V supply.

The devices are insensitive to supply voltage hum, and there is therefore little need for smoothing capacitors.

FEATURES

- Outstanding Limiting Qualities
- High AM Suppression
- Wide Supply Voltage Range
- Low External Component Count
- Low Intermodulation due to IF Voltage
- No Selection for Volume Control Characteristic Necessary
- Designed for use with Ceramic Filters (TBA120T only)

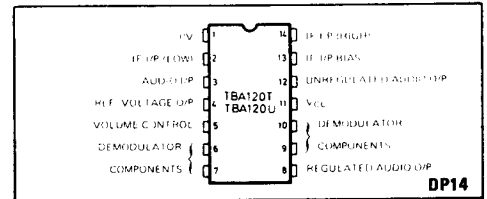

Fig. 1 Pin connections

APPLICATIONS

- TV Sound Systems
- FM Radio Receivers
- FM Tuners

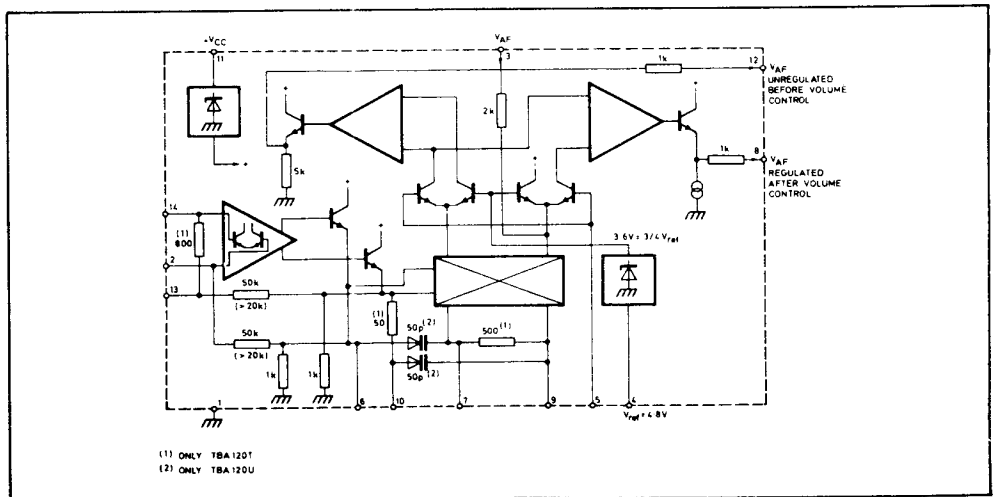

Fig. 2 Block diagram

ELECTRICAL CHARACTERISTICS

Test conditions (unless otherwise stated):

$V_{CC} = 12V$
 $T_{amb} = +25^{\circ}C$

Characteristic	Symbol	Value			Units	Conditions
		Min.	Typ.	Max.		
Total current consumption	I_{CC}	9.5	13.5	17.5	mA	$f_{IF} = 5.5 \text{ MHz}$
IF voltage gain V_6/V_{14}	G_V		68		dB	
Output voltage with limiting at each output			250		mVp-p	$V_{in} = 0$
Output impedance Pin 8	R_8		1.1		k Ω	
Pin 12	$R_{1,2}$		1.1		k Ω	
Input impedance	R_3		2		k Ω	
Internal impedance	R_4		12		Ω	
DC level of output signal ($V_{in} = 0$)	V_8		4		V	
	$V_{1,2}$		5.6		V	
Stabilized voltage	V_4	4.2	4.8	5.3	V	
Residual IF voltage without deemphasis	V_8		20		mV	
	$V_{1,2}$		30		mV	
AF gain (AF not regulated)	V_8/V_3		7.5			$R_{4-5} = 5k\Omega, R_{5-1} = 13k\Omega$
Regulation at certain ratio of divider	$V_{AF/8}$	20	28	36	dB	
Range of volume control (referred to pin 8)	$\frac{V_{AFmax}}{V_{AFmin}}$	70	85		dB	
Resistance (see note 1)	R_{4-5}	1		10	k Ω	$f_{IF} = 5.5 \text{ MHz}, \Delta f = \pm 50\text{kHz}, f_{mod} = 1\text{kHz}$
Input voltage for limitation	V_{inlim}		30	60	μV	
Hum suppression	$V_8/V_{1,1}$		35		dB	
	$V_{1,2}/V_{1,1}$		30		dB	
TBA 120T only:						
Input impedance	Z_{in}		800/5		Ω/pF	$f_{IF} = 5.5 \text{ MHz}$
AM suppression	α_{AM}	50	60		dB	$f_{IF} = 5.5 \text{ MHz}, \Delta f = \pm 50\text{kHz}, V_{in} = 500\mu V, f_{mod} = 1\text{kHz}, m = 30\%$
AF output voltage	V_a	650	900		mV	$f_{IF} = 5.5 \text{ MHz}, \Delta f = \pm 50\text{kHz}, f_{mod} = 1\text{kHz}$
	$V_{1,2}$	400	650		mV	
TBA 120U only:						
Input impedance	Z_{in}	5/6	40/4.5		k Ω/pf	$f_{IF} = 5.5 \text{ MHz}$
AM suppression	α_{AM}	50	60		dB	$f_{IF} = 5.5 \text{ MHz}, \Delta f = \pm 50\text{kHz}, V_{in} = 500\mu V, f_{mod} = 1\text{kHz}, m = 30\%$
AF output voltage	V_{8eff}	850	1200		mV	$f_{IF} = 5.5 \text{ MHz}, \Delta f = \pm 50\text{kHz}, V_{in} = 500\mu V, f_{mod} = 1\text{kHz}, Q_8 \approx 45, k = 4\%$
Harmonic distortion	$V_{1,2eff}$	600	1000		mV	$f_{IF} = 5.5 \text{ MHz}, \Delta f = \pm 50\text{kHz}, V_{in} = 10\text{mV}, f_{mod} = 1\text{kHz}, Q_8 \approx 20$
	k		1		%	

NOTE

- If DC volume control is not used, pin 4 must be connected direct to pin 5.

ABSOLUTE MAXIMUM RATINGS

Supply voltage V_{CC}	18V	Reference voltage O/P current, I_4	5mA
Operating ambient temperature, T_{amb}	-10 to +65 $^{\circ}C$	IF input resistance, $R_{1,3-1,4}$ (TBA120U)	< 1k Ω
Storage temperature, T_{stg}	-55 to +125 $^{\circ}C$	Range of supply operation, V_{CC}	10 to 18V
Total power dissipation, P_{TOT}	400mW	Frequency range, f	0 to 12 MHz
Volume control voltage, V_5	6V		

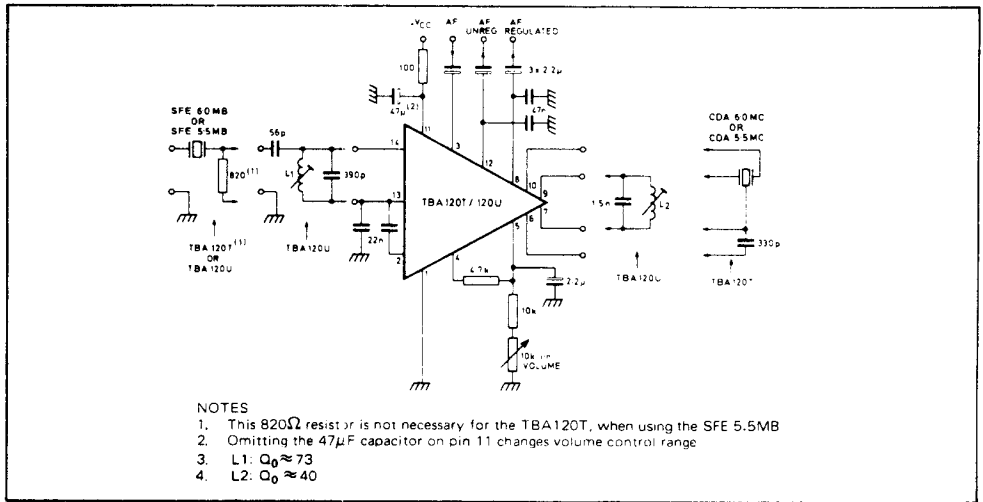

Fig. 3 Recommended application circuit

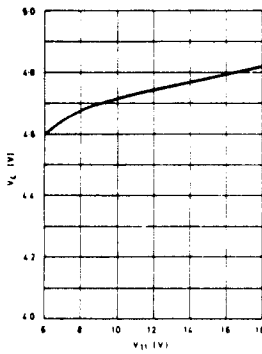

Fig. 4 Z voltage v. supply voltage

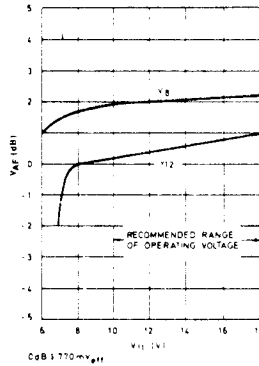

Fig. 5 AF output voltage v. supply voltage

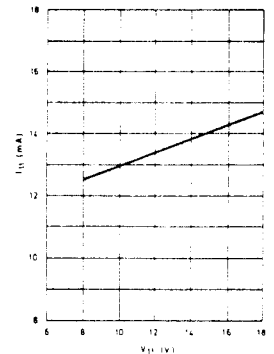

Fig. 6 Total current consumption v. supply voltage

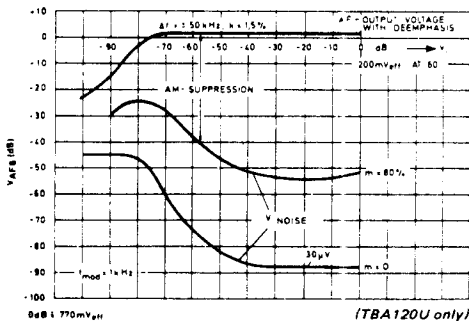

Fig. 7 AF output voltage and noise voltage v. input voltage (input Murata SFE 5.5MB)

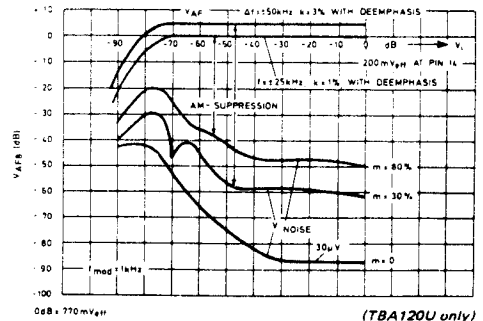

Fig. 8 AF output voltage and noise voltage v. input voltage (input 60Ω impedance, broadband)

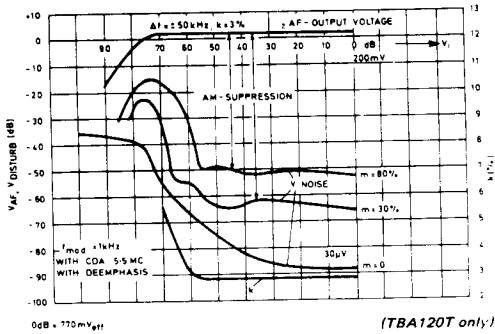

Fig. 9 AF output voltage (pin 8), noise voltage and harmonic distortion v. input voltage.

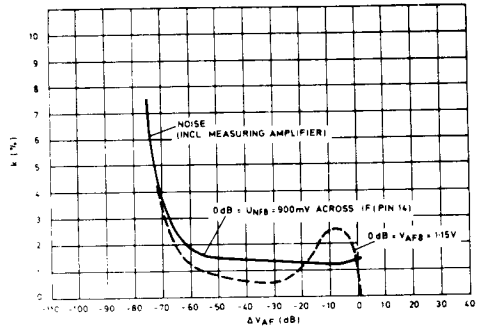

Fig. 10 Harmonic distortion v. volume control

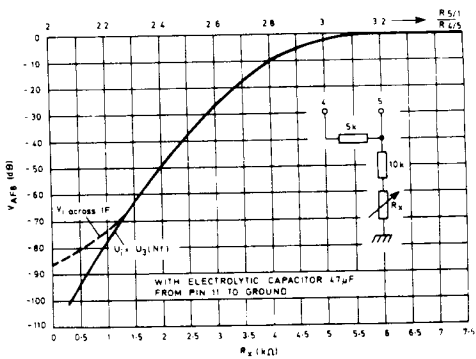

Fig. 11 AF output voltage (pin 8) v. potentiometer resistance and v. ratio of resistances

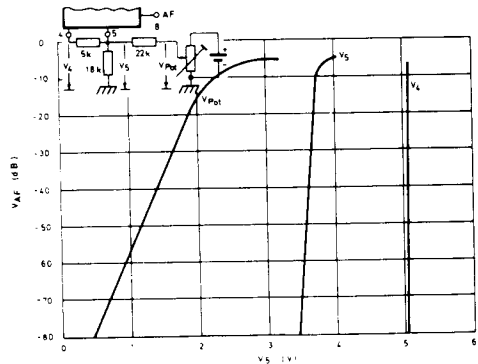

Fig. 12 AF output voltage (pin 8) v. voltage feeding into pin 5
 $V_{iRF} = 60mV_{eff}$, $f_{IF} = 5.5 MHz$, $\Delta f = \pm 50kHz$, $f_{mod} = 1kHz$, $V_{CC} = 18V$

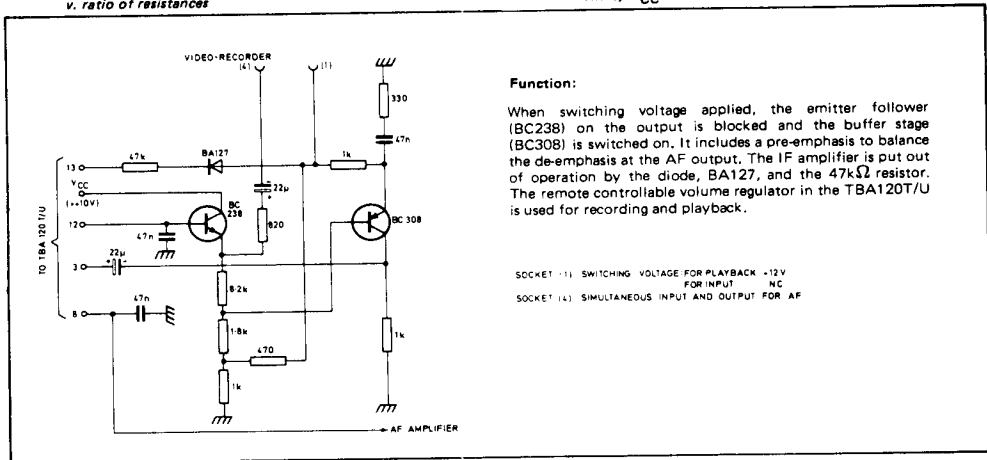

Fig. 13 Circuit for direct connection to video recorders

Function:

When switching voltage applied, the emitter follower (BC238) on the output is blocked and the buffer stage (BC308) is switched on. It includes a pre-emphasis to balance the de-emphasis at the AF output. The IF amplifier is put out of operation by the diode, BA127, and the 47kΩ resistor. The remote controllable volume regulator in the TBA120/U is used for recording and playback.

SOCKET (11) SWITCHING VOLTAGE FOR PLAYBACK -12V FOR INPUT NC
 SOCKET (14) SIMULTANEOUS INPUT AND OUTPUT FOR AF