

Arbitrary Function Generator

AFG-2225

User Manual

GW INSTEK PART NO.82RF-2225oMo1



ISO-9001 CERTIFIED MANUFACTURER

GW INSTEK

This manual contains proprietary information, which is protected by copyright. All rights are reserved. No part of this manual may be photocopied, reproduced or translated to another language without prior written consent of Good Will Corporation.

The information in this manual was correct at the time of printing. However, Good Will continues to improve its products and therefore reserves the right to change the specifications, equipment, and maintenance procedures at any time without notice.

Good Will Instrument Co., Ltd.
No. 7-1, Jhongsing Rd., Tucheng Dist., New Taipei City 236, Taiwan.

Table of Contents

S	SAFETY INSTRUCTIONS.....	6
G	GETTING STARTED	11
	Main Features	11
	Panel Overview.....	13
	Setting Up the function Generator.....	19
Q	QUICK REFERENCE	21
	How to use the Digital Inputs	23
	How to use the Help Menu	25
	Selecting a Waveform	27
	Modulation.....	29
	Sweep.....	34
	Burst	35
	ARB.....	37
	Utility Menu	40
	Frequency Counter.....	41
	Coupling.....	42
	Menu Tree	44
	Default Settings	52
O	OPERATION	54
	Select a Waveform	55
M	MODULATION.....	64
	Amplitude Modulation (AM)	66
	Frequency Modulation (FM)	75
	Frequency Shift Keying (FSK) Modulation.....	84
	Phase Modulation (PM)	91
	SUM modulation	100
	Frequency Sweep	108

Burst Mode	118
------------------	-----

SECONDARY SYSTEM FUNCTION SETTINGS 131

Save and Recall	132
System and Settings	136
System and Settings	136

CHANNEL SETTINGS 143

ARBITRARY WAVEFORMS..... 147

Inserting Built-In Waveforms	148
Display an Arbitrary Waveform	150
Editing an Arbitrary Waveform	159
Output an Arbitrary Waveform	169
Saving/Loading an Arbitrary Waveform	171

REMOTE INTERFACE..... 180

Establishing a Remote Connection	181
Command List	189
System Commands	193
Status Register Commands	196
System Remote Commands	199
Apply Commands	200
Output Commands	206
Pulse Configuration Commands	216
Amplitude Modulation (AM) Commands	218
AM Overview	218
Frequency Modulation (FM) Commands	223
FM Overview	223
Frequency-Shift Keying (FSK) Commands	228
FSK Overview	228
Phase Modulation (PM) Commands	232
PM Overview	232

SUM Modulation (SUM) Commands	236
SUM Overview.....	236
Frequency Sweep Commands	240
Sweep Overview	240
Burst Mode Commands.....	249
Burst Mode Overview	249
Arbitrary Waveform Commands	260
Arbitrary Waveform Overview	260
COUNTER	266
PHASE.....	267
COUPLE	268
Save and Recall Commands	271
Error Messages	273
SCPI Status Register.....	287
APPDENIX	293
AFG-2225 Specifications.....	293
EC Declaration of Conformity	298
INDEX	299

S SAFETY INSTRUCTIONS

This chapter contains important safety instructions that should be followed when operating and storing the function generator. Read the following before any operation to ensure your safety and to keep the function generator in the best condition.

Safety Symbols

These safety symbols may appear in this manual or on the instrument.



Warning: Identifies conditions or practices that could result in injury or loss of life.



Caution: Identifies conditions or practices that could result in damage to the function generator or to other objects or property.



DANGER High Voltage



Attention: Refer to the Manual



Protective Conductor Terminal



Earth (Ground) Terminal



DANGER Hot Surface



Double Insulated



Do not dispose electronic equipment as unsorted municipal waste. Please use a separate collection facility or contact the supplier from which this instrument was purchased.

Safety Guidelines

General Guideline



CAUTION

- Do not place heavy objects on the instrument.
- Do not place flammable objects on the instrument.
- Avoid severe impact or rough handling that may damage the function generator.
- Avoid discharges of static electricity on or near the function generator.
- Use only mating connectors, not bare wires, for the terminals.
- The instrument should only be disassembled by a qualified technician.

(Measurement categories) EN 61010-1:2010 specifies the measurement categories and their requirements as follows. The AFG-2225 falls under category II.

- Measurement category IV is for measurement performed at the source of a low-voltage installation.
- Measurement category III is for measurement performed in a building installation.
- Measurement category II is for measurement performed on circuits directly connected to a low voltage installation.
- Measurement category I is for measurements performed on circuits not directly connected to Mains.

Power Supply



WARNING

- AC Input voltage: 100 ~ 240V AC, 50 ~ 60Hz.
 - Connect the protective grounding conductor of the AC power cord to an earth ground to prevent electric shock.
-

Fuse



WARNING

- Fuse type: F1A/250V.
- Only qualified technicians should replace the fuse.
- To ensure fire protection, replace the fuse only with the specified type and rating.
- Disconnect the power cord and all test leads before replacing the fuse.
- Make sure the cause of fuse blowout is fixed before replacing the fuse.

Cleaning the function generator

- Disconnect the power cord before cleaning the function generator.
- Use a soft cloth dampened in a solution of mild detergent and water. Do not spray any liquid into the function generator.
- Do not use chemicals containing harsh products such as benzene, toluene, xylene, and acetone.

Operation Environment

- Location: Indoor, no direct sunlight, dust free, almost non-conductive pollution (Note below) and avoid strong magnetic fields.
- Relative Humidity: < 80%
- Altitude: < 2000m
- Temperature: 0°C to 40°C

(Pollution Degree) EN 61010-1:2010 specifies pollution degrees and their requirements as follows. The function generator falls under degree 2.

Pollution refers to “addition of foreign matter, solid, liquid, or gaseous (ionized gases), that may produce a reduction of dielectric strength or surface resistivity”.

- Pollution degree 1: No pollution or only dry, non-conductive pollution occurs. The pollution has no influence.
- Pollution degree 2: Normally only non-conductive pollution occurs. Occasionally, however, a temporary conductivity caused by condensation must be expected.
- Pollution degree 3: Conductive pollution occurs, or dry, non-conductive pollution occurs which becomes conductive due to condensation which is expected. In such conditions, equipment is normally protected against exposure to direct sunlight, precipitation, and full wind pressure, but neither temperature nor humidity is controlled.

Storage environment

- Location: Indoor
- Relative Humidity: < 70%
- Temperature: -10°C to 70°C

Disposal



Do not dispose this instrument as unsorted municipal waste. Please use a separate collection facility or contact the supplier from which this instrument was purchased. Please make sure discarded electrical waste is properly recycled to reduce environmental impact.

Power cord for the United Kingdom

When using the function generator in the United Kingdom, make sure the power cord meets the following safety instructions.

NOTE: This lead/appliance must only be wired by competent persons

 **WARNING: THIS APPLIANCE MUST BE EARTHED**

IMPORTANT: The wires in this lead are coloured in accordance with the following code:

Green/ Yellow:	Earth
Blue:	Neutral
Brown:	Live (Phase)



As the colours of the wires in main leads may not correspond with the coloured marking identified in your plug/ appliance, proceed as follows:

The wire which is coloured Green & Yellow must be connected to the Earth terminal marked with either the letter E, the earth symbol (⊕) or coloured Green/Green & Yellow.

The wire which is coloured Blue must be connected to the terminal which is marked with the letter N or coloured Blue or Black.

The wire which is coloured Brown must be connected to the terminal marked with the letter L or P or coloured Brown or Red.

If in doubt, consult the instructions provided with the equipment or contact the supplier.

This cable/ appliance should be protected by a suitably rated and approved HBC mains fuse: refer to the rating information on the equipment and/or user instructions for details. As a guide, a cable of 0.75mm² should be protected by a 3A or 5A fuse. Larger conductors would normally require 13A types, depending on the connection method used.

Any exposed wiring from a cable, plug or connection that is engaged in a live socket is extremely hazardous. If a cable or plug is deemed hazardous, turn off the mains power and remove the cable, any fuses and fuse assemblies. All hazardous wiring must be immediately destroyed and replaced in accordance to the above standard.

G GETTING STARTED

The Getting started chapter introduces the function generator's main features, appearance, set up procedure and power-up.

Main Features

Model name	Frequency bandwidth
AFG-2225	25MHz
Performance	<ul style="list-style-type: none"> • DDS Function Generator series • 1μHz high frequency resolution maintained at full range • 20ppm frequency stability • Arbitrary Waveform Capability <ul style="list-style-type: none"> 120 MSa/s sample rate 60 MSa/s repetition rate 4k-point waveform length 10 groups of 4k waveform memories True waveform output to display User-defined output section DWR (Direct Waveform Reconstruction) capability Waveform editing via PC
Features	<ul style="list-style-type: none"> • Sine, Square, Ramp, Pulse, Noise, standard waveforms • Internal and external LIN/LOG sweep with marker output

- Int/Ext AM, FM, PM, FSK, SUM modulation
 - Burst function with internal and external triggers without marker output
 - Store/recall 10 groups of setting memories
 - Output overload protection
-

Interface

- USB interface as standard
- 3.5 inch Color TFT LCD (320 X 240) graphical user interface
- AWES (Arbitrary Waveform Editing Software) PC software

Panel Overview

Front Panel

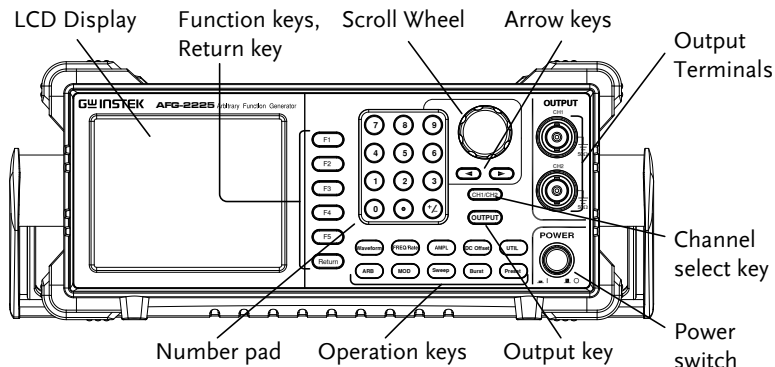

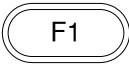

LCD Display TFT color display, 320 x 240 resolution.

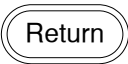
Function Keys F1~F5  Activates functions which appear on the right-hand side of the LCD display.

Return Key  Goes back to the previous menu level.

Operation Keys  The waveform key is used to select a type of waveform.

 The FREQ/Rate key is used to set the frequency or sample rate.

 AMPL sets the waveform amplitude.

 Sets the DC offset.



The UTIL key is used to access the save and recall options, update and view the firmware version, access the calibration options, output impedance settings and frequency meter.



ARB is used to set the arbitrary waveform parameters.



The MOD, Sweep and Burst keys are used to set the modulation, sweep and burst settings and parameters.



Preset Key



The preset key is used to recall a preset state.

Output Key



The Output key is used to turn on or off the waveform output.

Channel Select Key

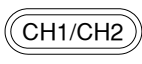

The channel select key is used to switch between the two output channels.

Output ports

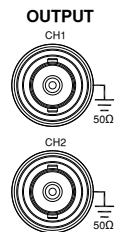

CH1: Channel 1 output port
CH2: Channel 2 output port

Power Button

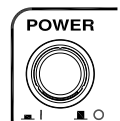

Turns the power on or off.

Arrow Keys



Used to select digits when editing parameters.

Scroll Wheel

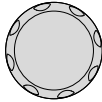

The scroll wheel is used to edit values and parameters.

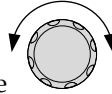

Decrease

Increase

Keypad

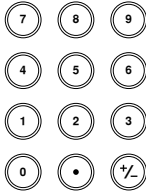

The digital keypad is used to enter values and parameters. The keypad is often used in conjunction with the arrow keys and variable knob.

Rear Panel

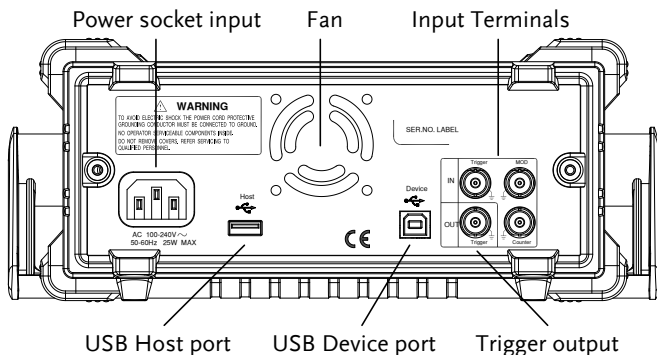

Trigger Input

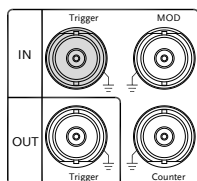

External trigger input. Used to receive external trigger signals.

Trigger Output

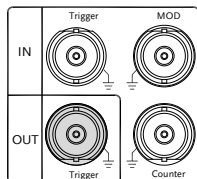

Marker output signal. Used for Sweep and ARB mode only.

Fan

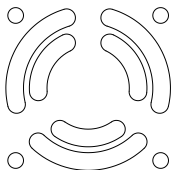

Fan.

Power Input Socket

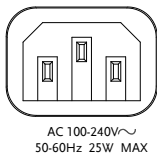

Power input: 100~240V AC
50~60Hz.

USB Host



USB type-A host port.

USB Device
Port

USB type-B device port is used to connect the function generator to a PC for remote control.

Counter Input

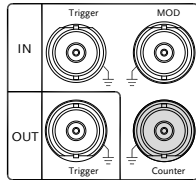

Frequency counter input.

MOD Input

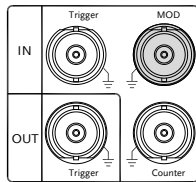

Modulation input terminal.

Display

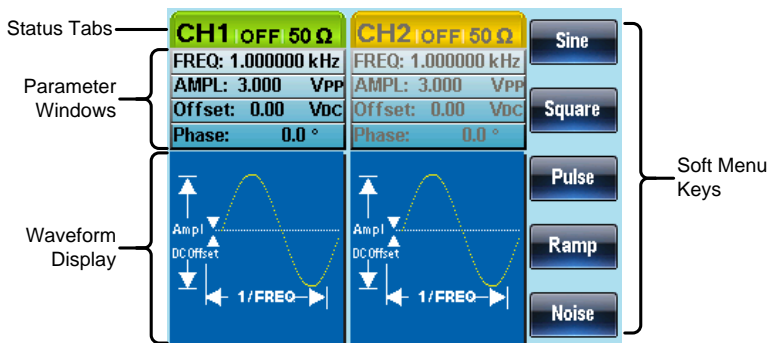

Parameter Windows The Parameter display and edit window.

Status Tabs Displays the current channel and setting status.

Waveform Display Used to display the waveform

Soft Menu Keys The function keys (F1~F5) beside the Soft Menu keys correspond to the soft keys.

Setting Up the function Generator

Background This section describes how to adjust the handle and power up the function generator.

Adjusting the Handle

Pull out the handle sideways and rotate it.

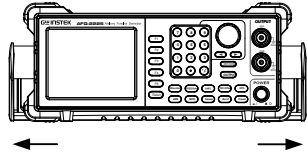

Place the AFG-2225 horizontally,

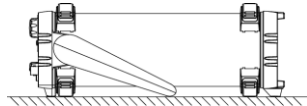

Or tilt the stand.

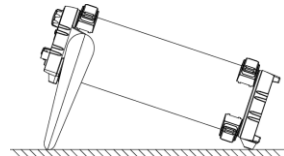

Place the handle vertically to hand carry.

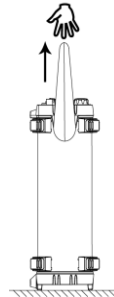

Power Up

1. Connect the power cord to the socket on the rear panel.

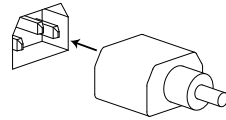

2. Turn on the power switch on the front panel.



3. When the power switch is turned on the screen displays the loading screen.



The function generator is now ready to be used.

QUICK REFERENCE

This chapter describes the operation shortcuts, built-in help and factory default settings. This chapter is to be used as a quick reference, for detailed explanations on parameters, settings and limitations, please see the operation chapters.

How to use the Digital Inputs	23
How to use the Help Menu	25
Selecting a Waveform	27
Square Wave.....	27
Ramp Wave	27
Sine Wave.....	28
Modulation.....	29
AM	29
FM.....	30
FSK Modulation.....	31
PM Modulation	32
SUM Modulation.....	33
Sweep.....	34
Burst	35
ARB	37
ARB-Add Built-In Waveform.....	37
ARB- Add Point.....	37
ARB- Add Line	38
ARB- Output Section	38
Utility Menu	40
Save	40
Recall	40
Frequency Counter.....	41
Frequency Counter	41
Coupling.....	42
Frequency Coupling	42
Amplitude Coupling	42

Tracking.....	43
Menu Tree	44
Waveform.....	44
ARB-Display.....	45
ARB-Edit	46
ARB- Built In.....	46
ARB-Save	47
ARB-Load.....	47
ARB-Output.....	48
MOD	48
SWEEP.....	49
SWEEP- More.....	49
Burst- N Cycle	50
Burst – Gate	50
UTIL.....	51
CH1/CH2	51

How to use the Digital Inputs

Background

The AFG-2225 has three main types of digital inputs: the number pad, arrow keys and scroll wheel. The following instructions will show you how to use the digital inputs to edit parameters.

1. To select a menu item, press the corresponding function keys below (F1~F5). For example the function key F1 corresponds to the Soft key "Sine".



2. To edit a digital value, use the arrow keys to move the cursor to the digit that needs to be edited.



CH1 ON 50Ω	CH2 ON 50Ω
FREQ: 1.000000kHz	FREQ: 1.000000kHz
AMPL: 3.00Vpp	AMPL: 3.00Vpp
Offset: 0.00Vdc	Offset: 0.00Vdc
Phase: 0.0°	Phase: 0.0°

3. Use the scroll wheel to edit the parameter. Clockwise increases the value, counter clockwise decreases the value.

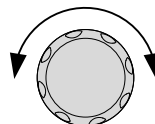



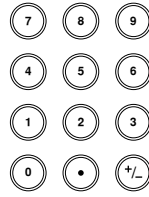

4. Alternatively, the number pad can be used to set the value of a highlighted parameter.



How to use the Help Menu

Background Every key and function has a detailed description in the help menu.

1. Press UTIL 
2. Press System (F3)  
3. Press Help (F2)  

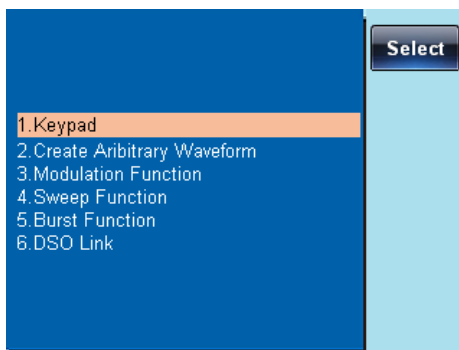

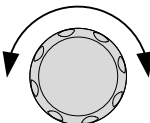
4. Use the scroll wheel to navigate to a help item. Press  Select to choose the item.

Keypad	Provides help on any front panel key that is pressed.
Create Arbitrary Waveform	Provides help on creating arbitrary waveforms.
Modulation Function	Explains how to create Modulated waveforms.
Sweep Function	Provides help on the Sweep function.

- Burst Function Provides help on the Burst function.
- DSO Link Provides help on DSO link.

5. For example, select item 4 to see help on the sweep functions.

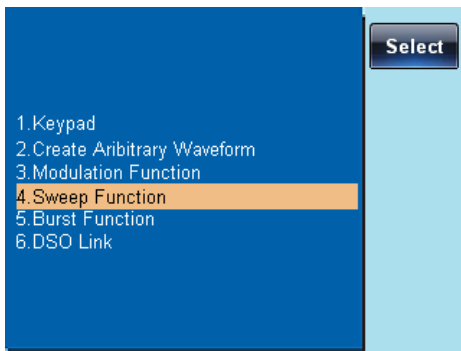

6. Use the scroll wheel to navigate the help information.

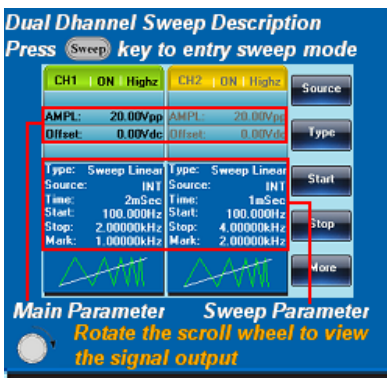

7. Press Return to return to the previous menu.



Selecting a Waveform

Square Wave

Example: Square wave, 3Vpp, 75% duty cycle, 1kHz.

Output:

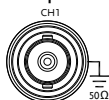

1. Press Waveform and select Square (F2).



2. Press Duty (F1), 7 + 5 + % (F2).



Input: N/A

3. Press Freq/Rate, 1 + kHz (F4).



4. Press AMPL followed by, 3 + VPP (F5).



5. Press the Output key.



Ramp Wave

Example: Ramp Wave, 5Vpp, 10kHz, 50% Symmetry.

Output:

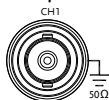

1. Press the Waveform key, and select Ramp (F4).





2. Press SYM(F1), 5 + 0 + % (F2).



Input: N/A

3. Press the Freq/Rate key then 1 + 0 + kHz (F4).



4. Press the AMPL key  5  then 5 +VPP (F5).
5. Press the Output key. 







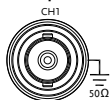





Sine Wave

Example: Sine Wave, 10Vpp,100kHz

Output:



Input: N/A

1. Press the Waveform key  and select Sine  (F1).
2. Press the Freq/Rate key  followed by 1  + 0  + 0  + kHz  (F4).
3. Press the AMPL key  followed by 1  + 0  +VPP  (F5).
4. Press the output key. 

Modulation

AM

Example: AM modulation. 100Hz modulating square wave. 1kHz Sine wave carrier. 80% modulation depth.

Output:

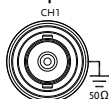

1. Press the MOD key and select AM (F1).



2. Press Waveform and select Sine (F1).



Input: N/A

3. Press the FREQ/Rate key, followed by 1 + kHz (F4).



4. Press the MOD key, select AM (F1), Shape (F4), Square (F2).



5. Press the MOD key, select AM (F1), AM Freq (F3).



6. Press 1 + 0 + 0 + Hz (F2).



7. Press the MOD key, select AM (F1), Depth (F2).

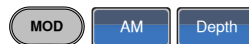

8. Press 8 + 0 + % (F1).



9. Press MOD, AM (F1), Source (F1), INT (F1).



10. Press the output key. 

FM

Example: FM modulation. 100Hz modulating square wave. 1kHz Sine wave carrier. 100 Hz frequency deviation. Internal Source.

Output:

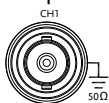

1. Press the MOD key and select FM (F2).



2. Press Waveform and select Sine (F1).



Input: N/A

3. Press the Freq/Rate key, followed by 1 + kHz (F4).



4. Press the MOD key, select FM (F2), Shape (F4), Square (F2).



5. Press the MOD key, select FM (F2), FM Freq (F3).



6. Press 1 + 0 + 0 + Hz (F2).





7. Press the MOD key, select FM (F2), Freq Dev (F2).



8. Press 1 + 0 + 0 + Hz (F3).





9. Press MOD, FM (F2), Source (F1), INT (F1).
 
10. Press the Output key.
 

FSK Modulation



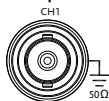



Example: FSK modulation. 100Hz Hop frequency. 1kHz Carrier wave. Sine wave. 10 Hz Rate. Internal Source.

Output:



1. Press the MOD key and select FSK (F3).
 
2. Press Waveform and select Sine (F1).
 

Input: N/A

3. Press the FREQ/Rate key, followed by 1 + kHz (F4).
 
4. Press the MOD key, select FSK (F3), FSK Rate (F3).
 
5. Press 1 + 0 + Hz (F2).
 
6. Press the MOD key, select FSK (F3), Hop Freq (F2).
 
7. Press 1 + 0 + 0 + Hz (F3).
 
8. Press MOD, FSK (F3), Source (F1), INT (F1).
 



9. Press the output key. 

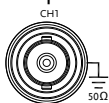

PM Modulation

Example: PM modulation. 800Hz sinusoidal carrier wave. 15 kHz modulating sine wave. 50° phase deviation. Internal Source.





Output:





1. Press Waveform and select Sine (**F1**).  



2. Press the MOD key and select PM (**F4**).  



Input: N/A

3. Press the Freq/Rate key, followed by 8 + 0 + 0 + Hz (**F3**).     





4. Press the MOD key, select PM (**F4**), Shape (**F4**), Sine (**F1**).    

5. Press MOD, then PM (**F4**), PM Freq (**F3**).   

6. Press 1 + 5 + kHz (**F3**).   

7. Press MOD, PM (**F4**), PM Dev (**F2**).   

8. Press 5 + 0 + Degree (**F1**).   

9. Press MOD, PM (**F4**), Source (**F1**), INT (**F1**).    



10. Press the Output key. 

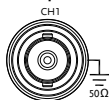

SUM Modulation

Example: SUM modulation. 100Hz modulating square wave, 1kHz sinusoidal carrier wave, 50% SUM amplitude, internal source.



Output:









1. Press the MOD key, then SUM (F5).  





2. Press Waveform, and select Sine (F1).  



Input: N/A



3. Press Freq/Rate followed by 1 + kHz (F4).   

4. Press the MOD key, SUM (F5), Shape (F4), Square (F2).    

5. Press the MOD key and select SUM (F5), SUM Freq (F3).   

6. Press 1 + 0 + 0 + Hz (F2).    

7. Press the MOD key and select SUM (F5), SUM Ampl (F2).   

8. Press 5 + 0 + % (F1).   

9. Press MOD, SUM (F5), Source (F1), INT (F1).
- 

10. Press the Output key.
- 

Sweep

Example: Frequency Sweep. Start Frequency 10mHz, Stop frequency 1MHz. Log sweep, 1 second sweep, Marker Frequency 550 Hz, Manual Trigger.

Output:

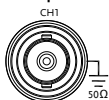



1. Press Sweep, Start (F3).
- 

2. Press 1 + 0 + mHz (F2).
- 

3. Press Sweep, Stop (F4).
- 

Input: N/A

4. Press 1 + MHz (F5).
- 

5. Press Sweep, Type (F2), Log (F2).
- 

6. Press Sweep, More (F5), SWP Time (F1).
- 

7. Press 1 + SEC (F2).
- 

8. Press Sweep, More (F5), Marker (F4), ON/OFF (F2), Freq (F1).
- 

9. Press 5 + 5 + 0 + Hz (F3).

10. Press the Output key.

11. Press Sweep, Source (F1), Manual (F3), Trigger (F1).

Burst

Example: Burst Mode, N-Cycle (Internally triggered), 1kHz burst frequency, Burst count = 5, 10 ms Burst period, 0° burst phase, Internal trigger, 10 us delay, rising edge trigger out

Output:

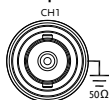

1. Press **FREQ/Rate** 1 kHz (F4).

2. Press **Burst**, **N Cycle** (F1), **Cycles** (F1).

Input: N/A

3. Press 5 + **Cyc** (F2).

4. Press **Burst**, **N Cycle** (F1), **Period** (F4).

5. Press 1 + 0 + **mSEC** (F2).

6. Press **Burst**, **N Cycle** (F1), **Phase** (F3).

7. Press 0 + **Degree** (F2).

8. Press **Burst**, **N Cycle** (F1), **TRIG set** (F5), **INT** (F1).

9. Press Burst, N Cycle (F1), TRIG set (F5), Delay (F4).



10. Press 1 + 0 + uSEC (F2).



11. Press Burst, N Cycle (F1), TRIG set (F5), TRIG out (F5), ON/OFF (F3), Rise (F1).



12. Press the Output key.



ARB

ARB–Add Built-In Waveform

Example: ARB Mode, Exponential Rise. Start 0, Length 100, Scale 327.

Output:

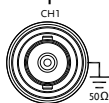

1. Press ARB, Built in (F3), Wave (F4), Math(F2), use the scroll wheel to select Exporise and then press Select(F5).

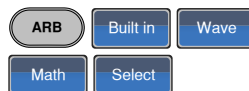

2. Press Start (F1), 0 + Enter (F2), Return.



3. Press Length (F2), 100, Enter (F2), Return.



4. Press Scale (F3), 327, Enter (F2), Return, Done (F5).



ARB- Add Point

Example: ARB Mode, Add point, Address 40, data 300.

Output:

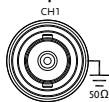

1. Press ARB, Edit (F2), Point (F1), Address (F1)



2. Press 4 + 0 + Enter (F2), Return





3. Press Data (F2), 3+0+0, Enter (F2). 

ARB- Add Line

Example: ARB Mode, Add line, Address:Data (10:30, 50:100)

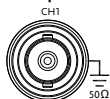
Output:



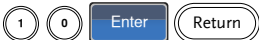
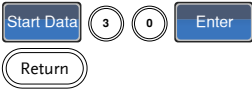
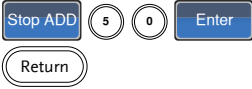
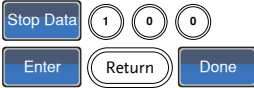

1. Press ARB, Edit (F2), Line (F2), Start ADD (F1). 
2. Press 1 + 0 + Enter (F2), Return. 
3. Press Start Data (F2), 3 + 0, Enter (F2), Return. 
4. Press Stop ADD (F3), 5 + 0, Enter (F2), Return. 
5. Press Stop Data (F4), 1 + 0 + 0, Enter (F2), Return, Done (F5). 





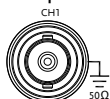

ARB– Output Section

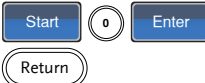
Example: ARB Mode, Output ARB Waveform, Start 0, Length 1000.

Output:





1. Press ARB, Output (F4). 
2. Press Start (F1), 0 + Enter (F2), Return. 

3. Press Length (F2), 1 +    
0 + 0, Enter (F2), 
Return. 

Utility Menu

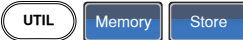

Save

Example: Save to Memory file #5.

1. Press UTIL, Memory (F1), Store (F1).
The diagram shows three buttons in a row: a white button with a black border labeled 'UTIL', a blue button labeled 'Memory', and a blue button labeled 'Store'.
2. Choose a setting using the scroll wheel and press Done (F5).
The diagram shows a scroll wheel with a circular arrow around it, and a blue button labeled 'Done' to its right.

Recall

Example: Recall Memory file #5.



1. Press UTIL, Memory (F1), Recall (F2).
The diagram shows three buttons in a row: a white button with a black border labeled 'UTIL', a blue button labeled 'Memory', and a blue button labeled 'Recall'.
2. Choose a setting using the scroll wheel and press Done (F5).
The diagram shows a scroll wheel with a circular arrow around it, and a blue button labeled 'Done' to its right.

Frequency Counter

Frequency Counter



Example: Turn on the frequency counter. Gate time: 1 second.

Output: N/A

1. Press UTIL, Counter  

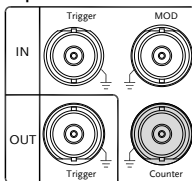
Input:







2. Press Gate Time (F1), and press 1 Sec (F3)   to choose a gate time of 1 second.

3. Connect the signal of interest to the Frequency counter input on the rear panel.

Coupling





Frequency Coupling

Example: Frequency Coupling

1. Press UTIL, Dual Chan (F4) to enter the coupling function.  
2. Press Freq Cpl (F1) to select the frequency coupling function. 
3. Press Offset (F2). The offset is the frequency difference between CH1 and CH2. Use the number keys or scroll wheel to enter the offset. 

Amplitude Coupling

Example: Amplitude Coupling

1. Press UTIL, Dual Chan (F4) to enter the coupling function.  
2. Press Ampl Cpl (F2), ON (F1) to select the amplitude coupling function.  

3. Couples the amplitude and offset between both channels. Any changes in amplitude in the current channel are reflected in the other channel.

Tracking

Example: Tracking

1. Press UTIL, Dual Chan (F4) to enter the coupling function.



2. Press Tracking (F3), ON (F2) to turn on the tracking function.



3. When tracking is turned on, parameters such as amplitude and frequency from the current channel are mirrored on the other channel.

Menu Tree

Conventions Use the menu trees as a handy reference for the function generator functions and properties. The AFG-2225 menu system is arranged in a hierarchical tree. Each hierarchical level can be navigated with the operation or soft menu keys. Pressing the Return key will return you to the previous menu level.

Waveform

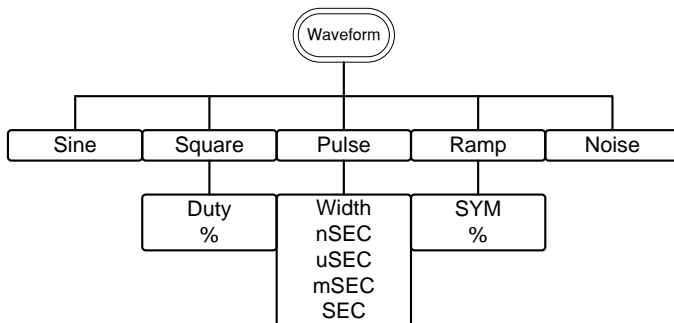

ARB-Display

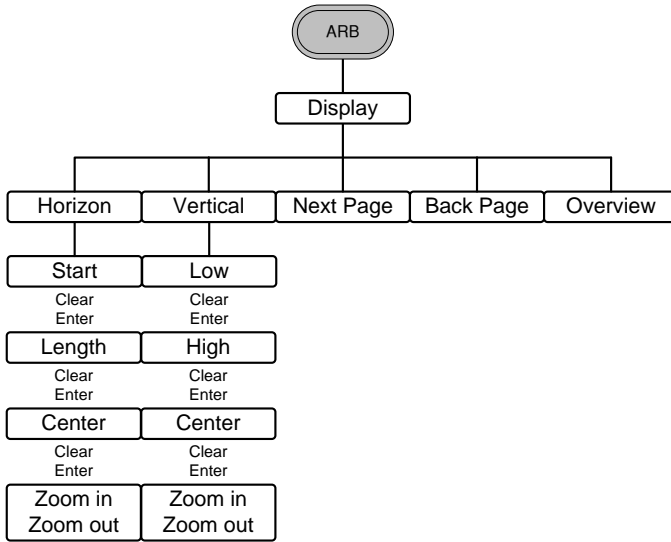

ARB-Edit

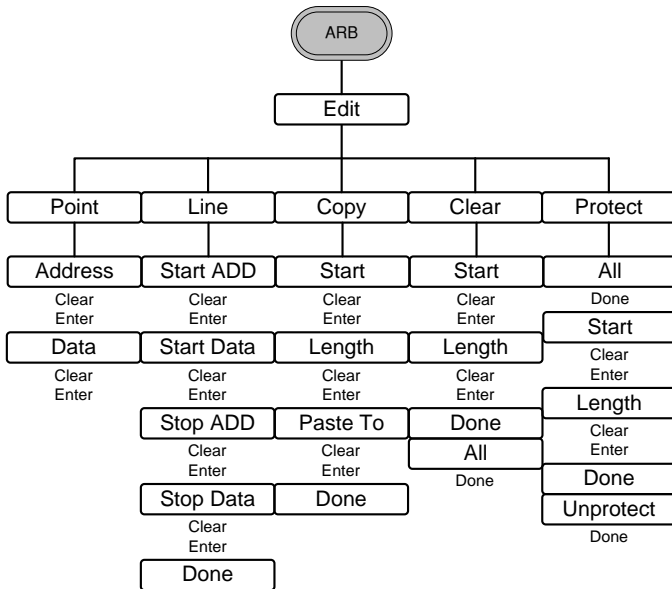

ARB- Built In

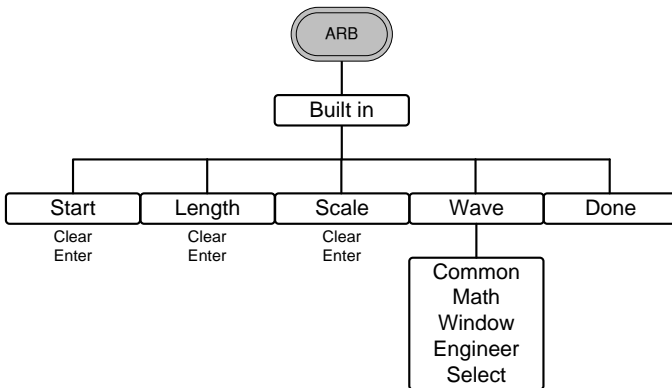

ARB-Save

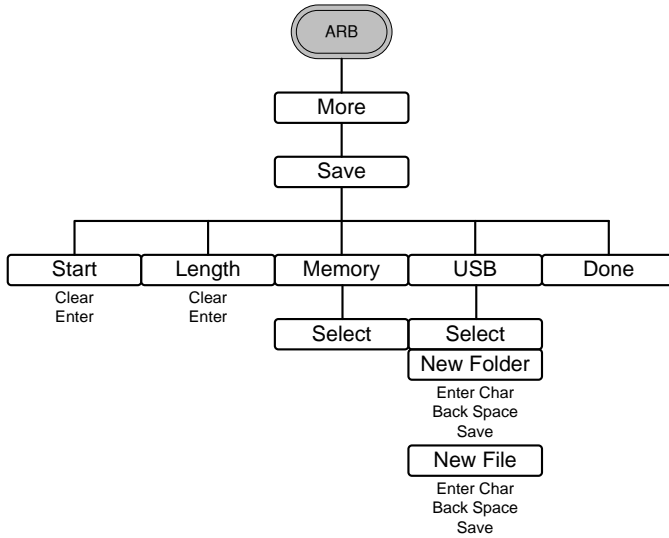

ARB-Load

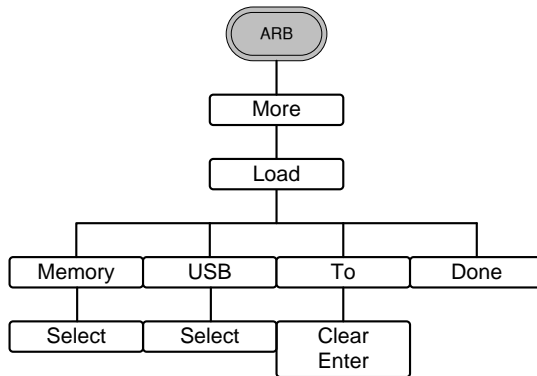

ARB-Output

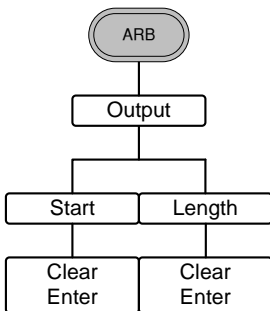

MOD

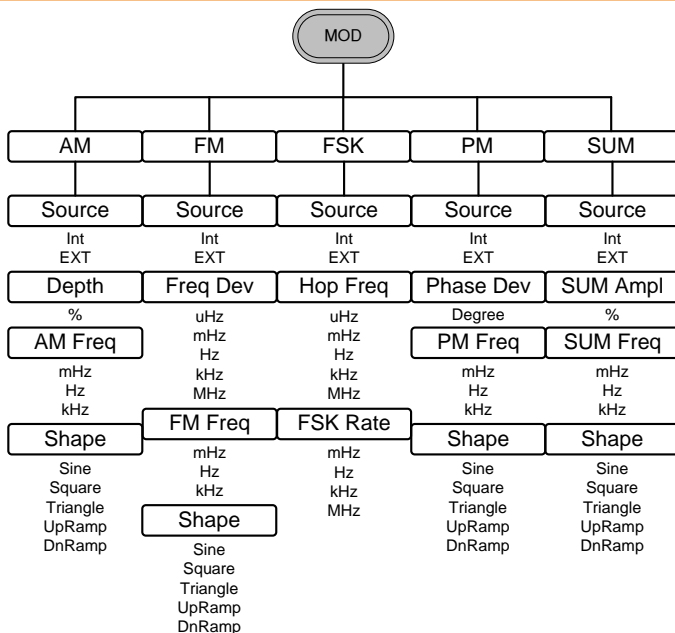

SWEEP

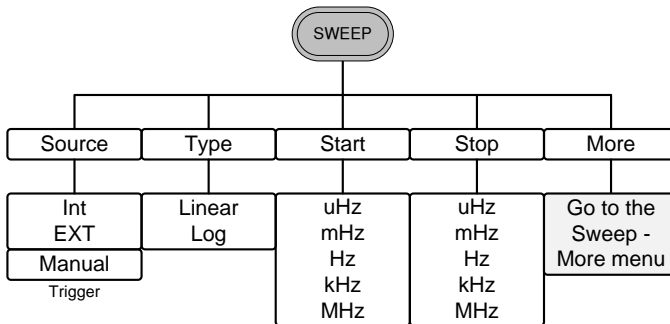

SWEEP- More

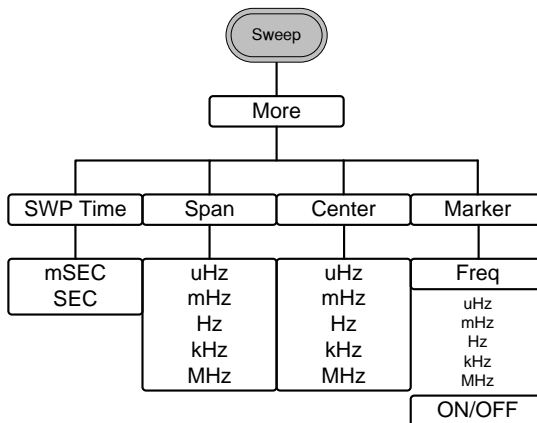

Burst- N Cycle

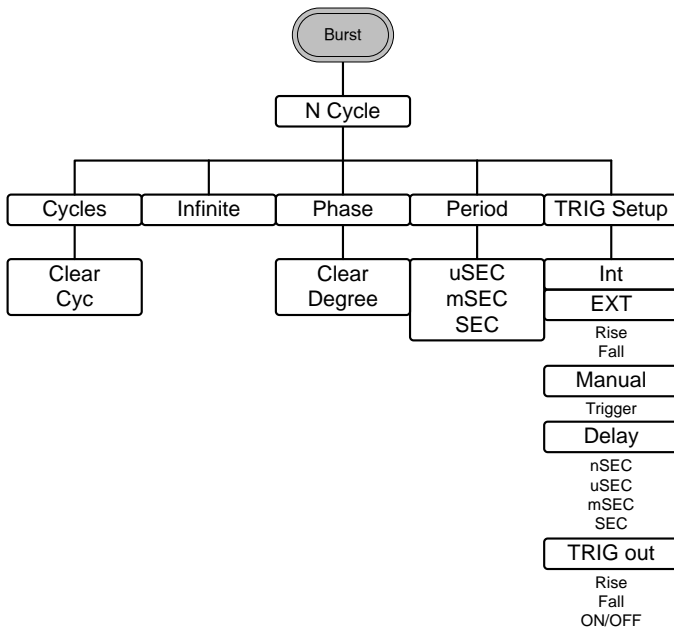

Burst – Gate

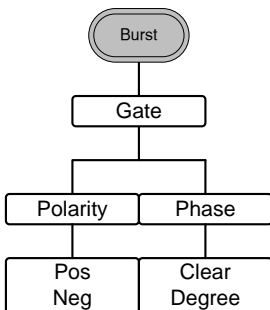

UTIL

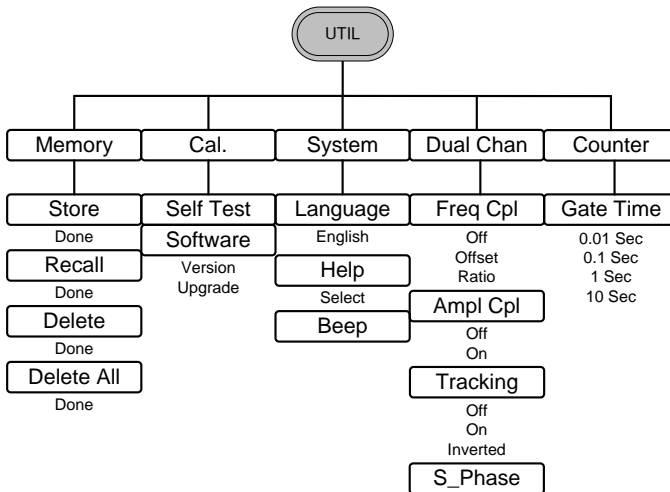

CH1/CH2

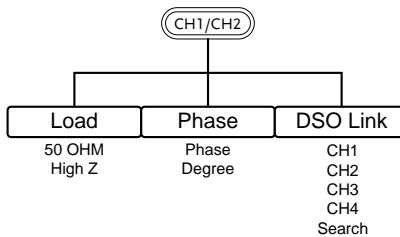

Default Settings

The Preset key is used to restore the default panel settings.



Output Settings	Function	Sine Wave
	Frequency	1kHz
	Amplitude	3.000 V _{pp}
	Offset	0.00V dc
	Output units	V _{pp}
	Output terminal	50Ω
Modulation		
(AM/FM/FSK/PM/SUM)		
	Carrier wave	1kHz sine wave
	Modulation wave	100Hz sine wave
	AM depth	100%
	FM deviation	100Hz
	FSK hop frequency	100Hz
	FSK frequency	10Hz
	PM phase deviation	180°
	SUM amplitude	50%
	Modem status	Off
Sweep		
	Start/Stop frequency	100Hz/1kHz
	Sweep time	1s
	Sweep type	Linear
	Sweep status	Off

Burst	Burst frequency	1kHz
	Ncycle	1
	Burst period	10ms
	Burst starting phase	0°
	Burst status	Off
System Settings	Power off signal	On
	Display mode	On
	Error queue	Cleared
	Memory settings	No change
	Output	Off
Trigger	Trigger source	Internal (immediate)
Calibration	Calibration Menu	Restricted

OPERATION

The Operation chapter shows how to output basic waveform functions. For details on modulation, sweep, burst and arbitrary waveforms, please see the Modulation and Arbitrary waveform chapters on pages 64 and 147.

Select a Waveform	55
Sine Wave.....	55
Square Wave	56
Setting the Pulse Width	57
Setting a Ramp Waveform	58
Selecting a Noise Waveform.....	59
Setting the Frequency	60
Setting the Amplitude	62
Setting the DC Offset.....	63

Select a Waveform

The AFG-2225 can output 5 standard waveforms: sine, square, pulse, ramp and noise.

Sine Wave





Panel Operation 1. Press the Waveform key.

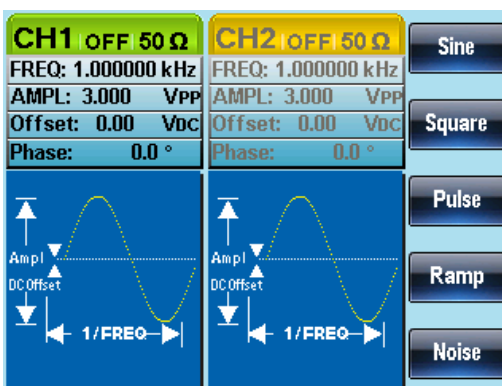



2. Press F1 (Sine).

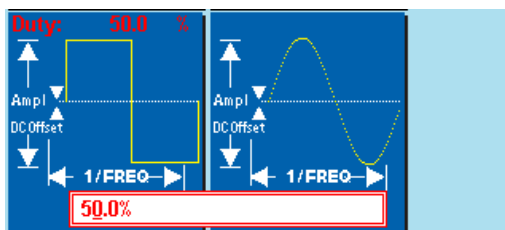

Square Wave

- Panel Operation
1. Press the Waveform key. 
 2. Press F2 (Square) to create a square waveform.  
 3. Press F1 (Duty). The Duty parameter will be highlighted in the parameter window.  

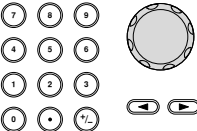

4. Use the arrow keys and scroll wheel or number pad to enter the Duty range. 
5. Press F2 (%) to select % units.  

Range	Frequency	Duty Range
	$\leq 100\text{kHz}$	1.0%~99.0%
	100kHz~ $\leq 1\text{MHz}$	10.0%~90.0%
	$> 1\text{MHz} \sim 25\text{MHz}$	50% (Fixed)

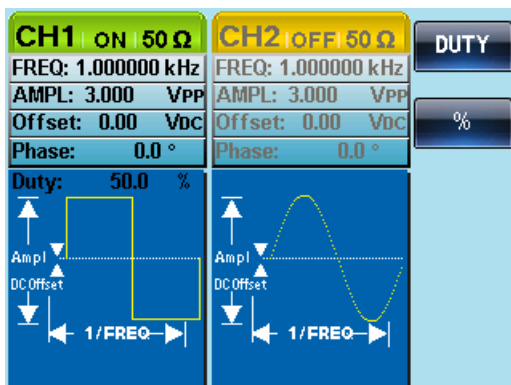

Setting the Pulse Width

Panel Operation 1. Press the Waveform key.



2. Press F3 (Pulse) to create a pulse width waveform.





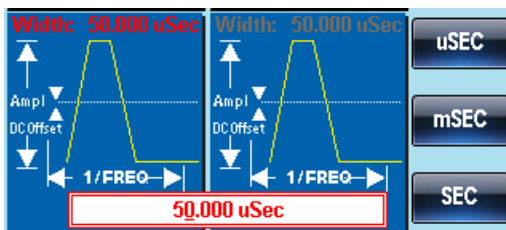

3. Press F1 (Width). The Width parameter will be highlighted in the parameter window.

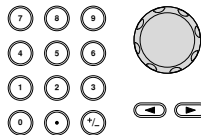

4. Use the arrow keys and scroll wheel or number pad to enter the pulse width.





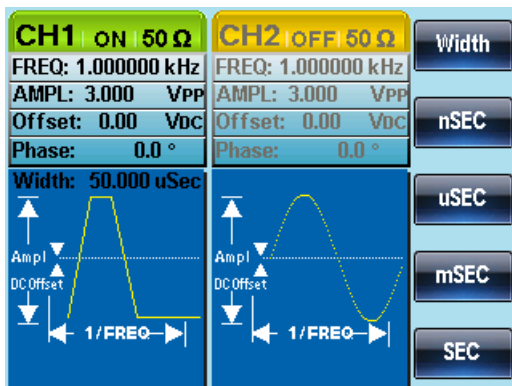

5. Press F2~F5 choose the unit  ~ 
 

Range	Pulse Width	20ns~1999.9s
 Note	Minimum Pulse Width	Frequency \leq 25MHz: 20ns pulse width. Frequency \leq 100 kHz: 1/4096 duty cycle.
	Resolution	Frequency \leq 25MHz: 20ns pulse width. Frequency \leq 100 kHz: 1/4096 duty cycle.



Setting a Ramp Waveform

- Panel Operation
1. Press the Waveform key. 
 2. Press F4 (Ramp) to create a ramp waveform.  
 3. Press F1 (SYM). The SYM parameter will be highlighted in the parameter window.  

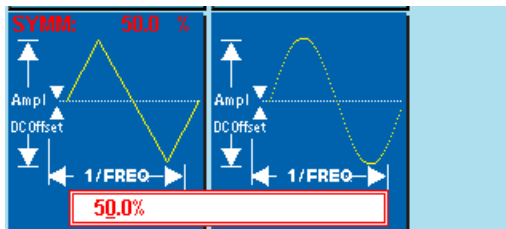

- Use the arrow keys and scroll wheel or number pad to enter the symmetry percentage.

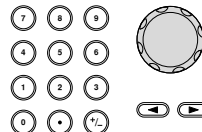

- Press F2 (%) to choose % units.



Range

Symmetry

0%~100%

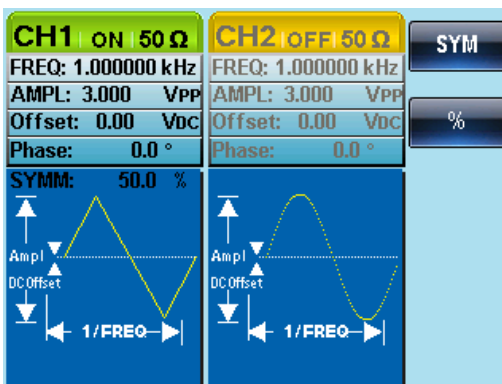

Selecting a Noise Waveform

- Press the Waveform key.



- Press F5 (Noise).



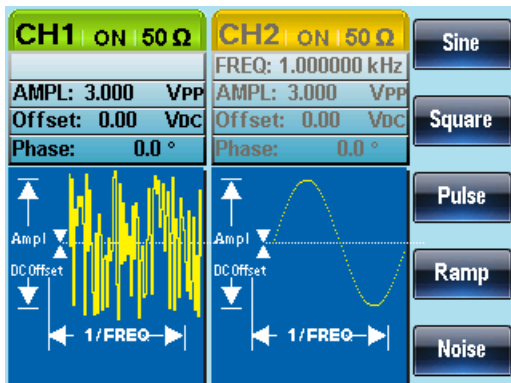

Setting the Frequency

Panel Operation 1. Press the **FREQ/Rate** key.



2. The **FREQ** parameter will become highlighted in the parameter window.



3. Use the arrow keys and scroll wheel or number pad to enter the frequency.

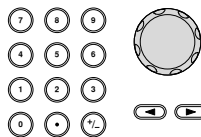

4. Choose a frequency unit by pressing **F1~F5**.

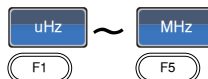

Range	Sine wave	1μHz~25MHz
	Square wave	1μHz~25MHz
	Pulse wave	500μHz~25MHz

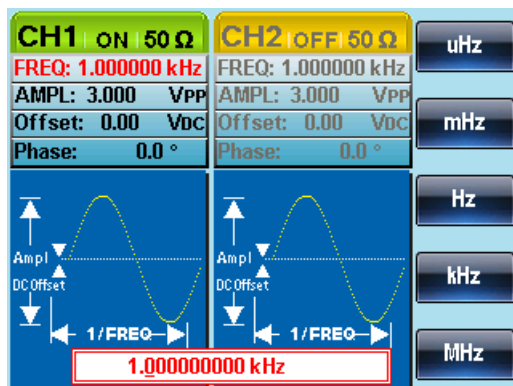
Ramp wave 1 μ Hz~1MHz

Setting the Amplitude

Panel Operation 1. Press the AMPL key.



2. The AMPL parameter will become highlighted in the parameter window.



3. Use the arrow keys and scroll wheel or number pad to enter the amplitude.

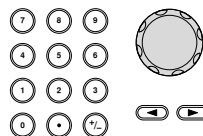

4. Choose a unit type by pressing F1~F5.

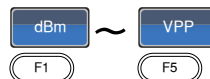

	50Ω load	High Z
Range	1mVpp~10Vpp	2mVpp~20Vpp
Unit	Vpp, Vrms, dBm	

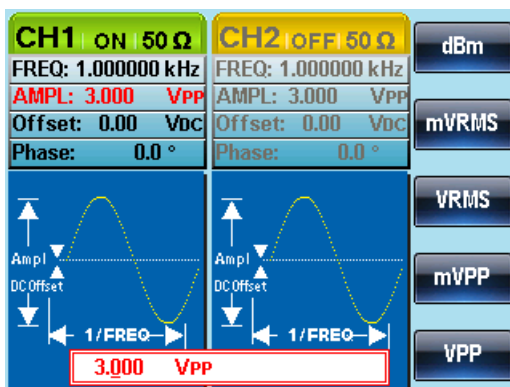

Setting the DC Offset

Panel Operation 1. Press the DC Offset key.



2. The DC Offset parameter will become highlighted in the parameter window.



3. Use the arrow keys and scroll wheel or number pad to enter the DC Offset.

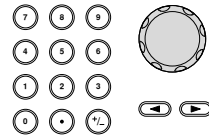

4. Press F1 (mVDC) or F2 (VDC) to choose a voltage range.

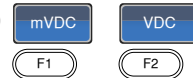

	50Ω load	High Z
Range	±5Vpk	±10Vpk

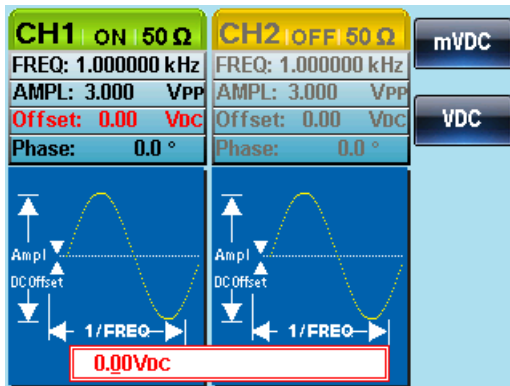

M MODULATION

The AFG-2225 Series Arbitrary Function Generators are able to produce AM, FM, FSK, PM and SUM modulated waveforms. Depending on the type of waveform produced, different modulation parameters can be set. Only one modulation mode can be active at any one time. The function generator also will not allow sweep or burst mode to be used with AM/FM. Activating a modulation mode will turn the previous modulation mode off.

Amplitude Modulation (AM)	66
Selecting AM Modulation	67
AM Carrier Shape	67
Carrier Frequency	68
Modulating Wave Shape	69
AM Frequency	70
Modulation Depth	72
Selecting the (AM) Modulation Source	73
Frequency Modulation (FM)	75
Selecting Frequency Modulation (FM)	76
FM Carrier Shape	76
FM Carrier Frequency	77
FM Wave Shape	78
FM Frequency	79
Frequency Deviation	81
Selecting (FM) Modulation Source	82
Frequency Shift Keying (FSK) Modulation	84
Selecting FSK Modulation	85
FSK Carrier Shape	85
FSK Carrier Frequency	86
FSK Hop Frequency	87
FSK Rate	88
FSK Source	90
Phase Modulation (PM)	91
Selecting Phase Modulation (PM)	92
PM Carrier Waveform	93
PM Carrier Frequency	93

PM Wave Shape	94
PM Frequency.....	95
Phase Deviation.....	97
Select the PM Source	98
SUM modulation	100
Selecting SUM modulation.....	101
SUM Carrier Waveform.....	101
SUM Carrier Frequency.....	102
SUM Waveform.....	103
Modulating Waveform Frequency.....	104
SUM Amplitude.....	105
Select the SUM Amplitude Source	106
Frequency Sweep	108
Selecting Sweep Mode.....	109
Setting Start and Stop Frequency	109
Center Frequency and Span	111
Sweep Mode.....	113
Sweep Time	114
Marker Frequency.....	115
Sweep Trigger Source.....	116
Burst Mode	118
Selecting Burst Mode.....	119
Burst Modes.....	119
Burst Frequency	120
Burst Cycle/Burst Count	121
Infinite Burst Count.....	123
Burst Period.....	123
Burst Phase	125
Burst Trigger Source	126
Burst Delay	128
Burst Trigger Output.....	129

Amplitude Modulation (AM)

An AM waveform is produced from a carrier waveform and a modulating waveform. The amplitude of the modulated carrier waveform depends on the amplitude of the modulating waveform. The AFG-2225 function generator can set the carrier frequency, amplitude and offset as well as internal or external modulation sources.

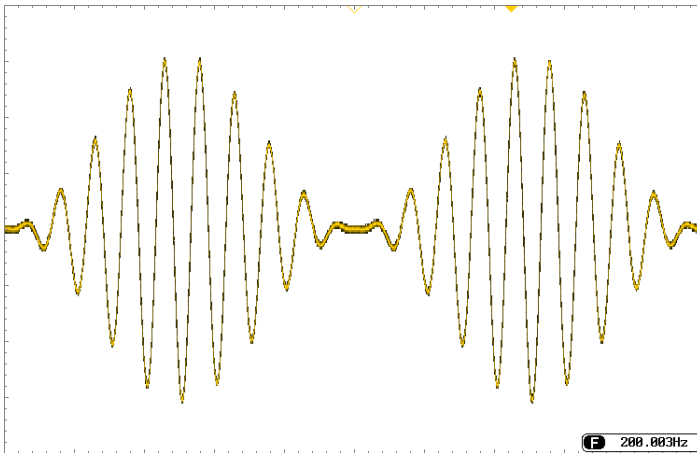

Selecting AM Modulation

Panel Operation 1. Press the MOD key.



2. Press F1 (AM).

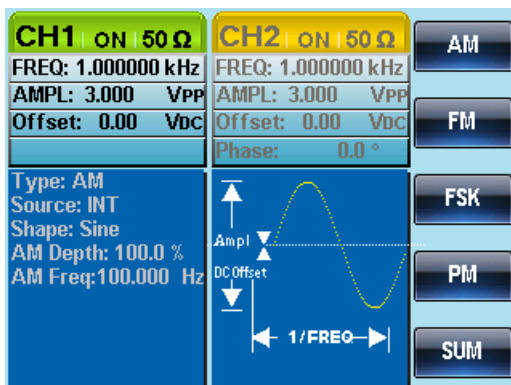

AM Carrier Shape

Background

Sine, square, ramp, pulse or arbitrary waveforms can be used as the carrier shape. The default waveform shape is set to sine. Noise is not available as a carrier shape. Before the carrier shape can be selected, choose AM modulation mode, see above.

Select a Standard Carrier Shape 1. Press the Waveform key.



2. Press F1~F4 to choose the carrier wave shape.

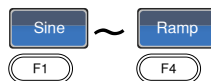

Select an Arbitrary Waveform Carrier Shape. 3. See the Arbitrary waveform quick reference or chapter to use an arbitrary waveform. Page 37 Page 147

Range AM Carrier Shape sine, square, Ramp,Pulse, arbitrary waveform

Carrier Frequency

The maximum carrier frequency depends on the carrier shape selected. The default carrier frequency for all carrier shapes is 1kHz.

Panel Operation 1. With a carrier waveform selected, press the  FREQ/Rate key.

2. The FREQ parameter will become highlighted in the parameter window.

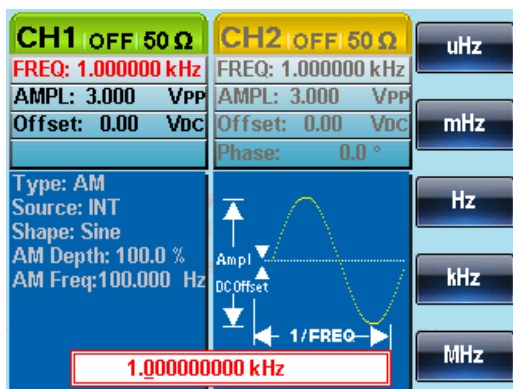

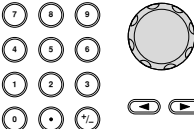
3. Use the arrow keys and scroll wheel or number pad to enter the carrier frequency. 

4. Press F1~F5 to select the frequency range.

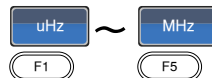

Range	Carrier Shape	Carrier Frequency
	Sine wave	1 μ Hz~ 25MHz
	Square wave	1 μ Hz~25MHz
	Ramp wave	1 μ Hz~1MHz
	Pulse wave	500uHz~25MHz
	Default frequency	1 kHz

Modulating Wave Shape

The function generator can accept internal as well as external sources. The AFG-2225 has sine, square, triangle, up ramp and down ramp modulating waveform shapes. Sine waves are the default wave shape.

Panel Operation

1. Press the MOD key.



2. Press F1 (AM).



3. Press F4 (Shape).



4. Press F1 ~ F5 to select the waveform shape.

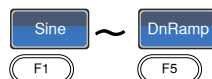

5. Press Return to return to the previous menu.



Note

Square wave	50% Duty cycle
UpRamp	100% Symmetry
Triangle	50% Symmetry
DnRamp	0% Symmetry

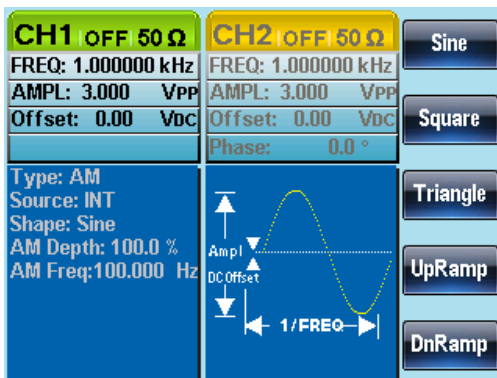

AM Frequency

The frequency of the modulation waveform (AM Frequency) can be set from 2mHz to 20kHz.

Panel Operation 1. Press the MOD key.



2. Press F1 (AM).



3. Press F3 (AM Freq)



4. The AM Freq parameter will become highlighted in the Waveform display area.

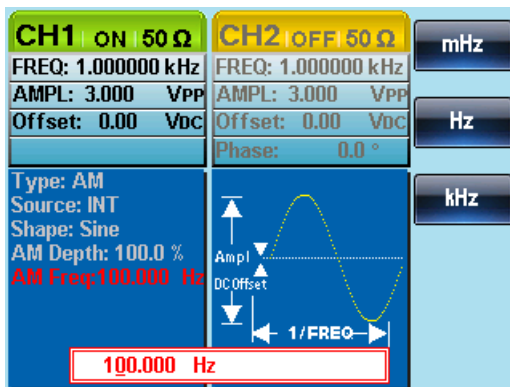

5. Use the arrow keys and scroll wheel or number pad to enter the AM frequency.

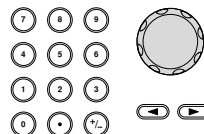

6. Press F1~F3 to select the frequency range.

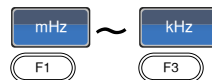

Range	Modulation frequency	2mHz~20kHz
	Default frequency	100Hz

Modulation Depth

Modulation depth is the ratio (as a percentage) of the unmodulated carrier amplitude and the minimum amplitude deviation of the modulated waveform. In other words, modulation depth is the maximum amplitude of the modulated waveform compared to the carrier waveform as a percentage.

Panel Operation 1. Press the MOD key.



2. Press F1 (AM).



3. Press F2 (Depth).



4. The AM Depth parameter will become highlighted in the waveform display area.

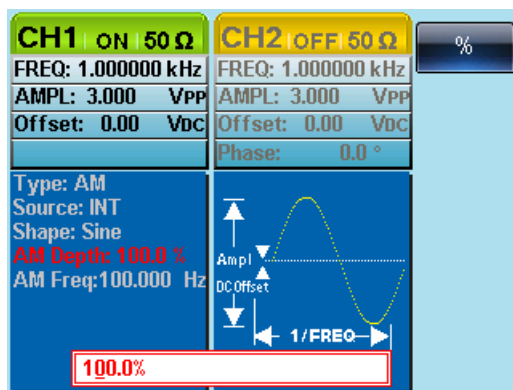

5. Use the arrow keys and scroll wheel or number pad to enter the AM depth.

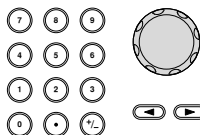

6. Press F1 (%) to choose % units.













Range	Depth	0%~120%
	Default depth	100%

Note When the modulation depth is greater than 100%, the output cannot exceed $\pm 5V_{Peak}$ (10k Ω load).

If an external modulation source is selected, modulation depth is limited to $\pm 5V$ from the MOD INPUT terminal on the rear panel. For example, if the modulation depth is set to 100%, then the maximum amplitude is +5V, and the minimum amplitude is -5V.

Selecting the (AM) Modulation Source

The function generator will accept an internal or external source for AM modulation. The default source is internal.

- Panel Operation**
1. Press the MOD key. 
 2. Press F1 (AM).  
 3. Press F1 (Source).  
 4. Press F1 (INT) or F2 (EXT) to select the modulation source.   
 
 5. Press Return to go back to the previous menu. 

External Source Use the MOD INPUT terminal on the rear panel when using an external source.

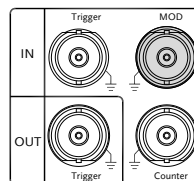

Note If an external modulation source is selected, modulation depth is limited to $\pm 5V$ from the MOD INPUT terminal on the rear panel. For example, if modulation depth is set to 100%, then the maximum amplitude is +5V, and the minimum amplitude is -5V.

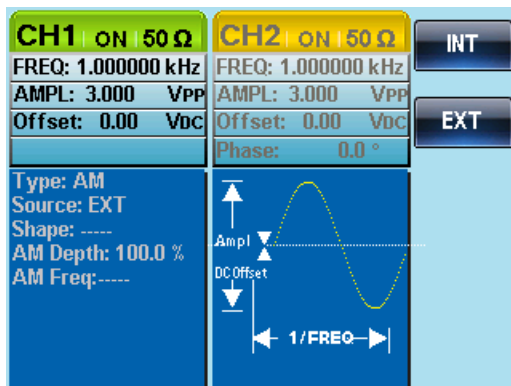

Frequency Modulation (FM)

A FM waveform is produced from a carrier waveform and a modulating waveform. The instantaneous frequency of the carrier waveform varies with the magnitude of the modulating waveform. When using the AFG-2225 function generator, only one type of modulated waveform can be created at any one time.

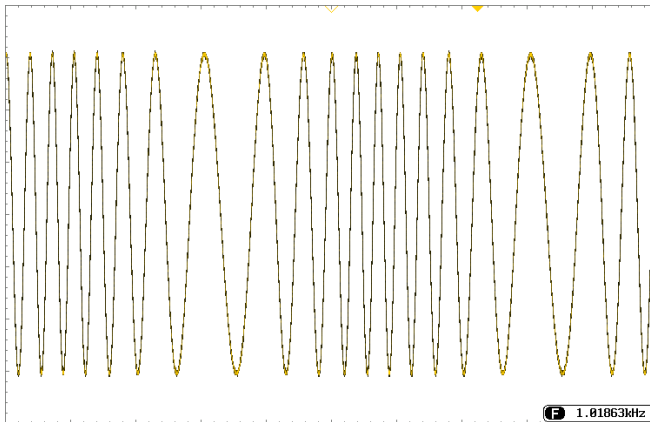

Selecting Frequency Modulation (FM)

When FM is selected, the modulated waveform depends on the carrier frequency, the output amplitude and offset voltage.

Panel Operation 1. Press the MOD key.



2. Press F2 (FM).

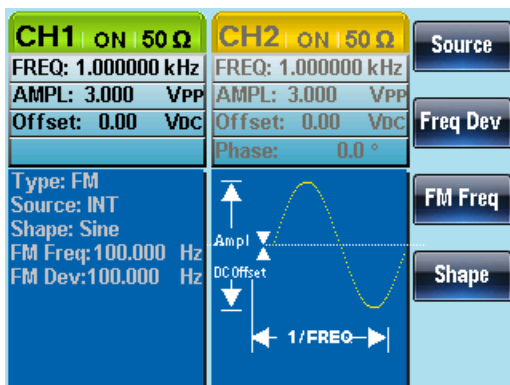

FMCarrier Shape

Background The default waveform shape is set to sine. Noise and pulse waveforms cannot be used as a carrier wave.

Panel Operation 1. Press the Waveform key.



2. Press F1~F4 to select the carrier shape.

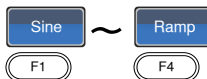

Range

Carrier Shape

Sine, Square, Ramp.

FM Carrier Frequency

When using the AFG-2225 function generator, the carrier frequency must be equal to or greater than the frequency deviation. If the frequency deviation is set to value greater than the carrier frequency, the deviation is set to the maximum allowed. The maximum frequency of the carrier wave depends on the waveform shape chosen.

- Panel Operation
1. To select the carrier frequency, press the
FREQ/Rate key.



2. The FREQ parameter will become highlighted in the parameter window.

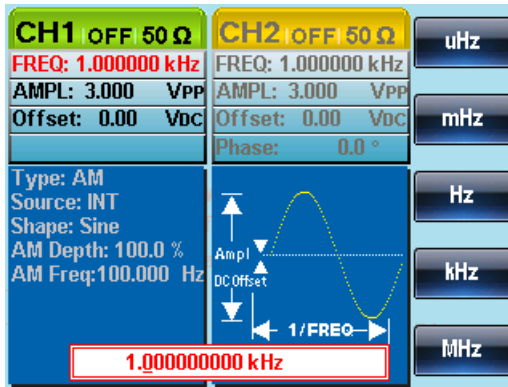

3. Use the arrow keys and scroll wheel or number pad to enter the carrier frequency.

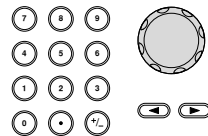

4. Press F1~F5 to select the frequency unit.

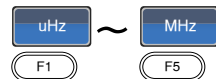

Range











Carrier Shape
Sine

Carrier Frequency
1μHz~25MH

Square	1μHz~15MHz
Ramp	1μHz~1MHz
Default frequency	1kHz

FM Wave Shape

The function generator can accept internal as well as external sources. The AFG-2225 has sine, square, triangle, positive and negative ramps (UpRamp, DnRamp) as the internal modulating waveform shapes. Sine is the default wave shape.

- | | | |
|------------|---|--|
| Background | 1. Select MOD. |  |
| | 2. Press F2 (FM). |   |
| | 3. Press F4 (Shape). |   |
| | 4. Press F1 ~ F5 to select the waveform shape. |  ~ 
  |
| | 5. Press Return to return to the previous menu. |  |

Range	Square wave	50% Duty cycle
	UpRamp	100% Symmetry
	Triangle	50% Symmetry
	DnRamp	0% Symmetry

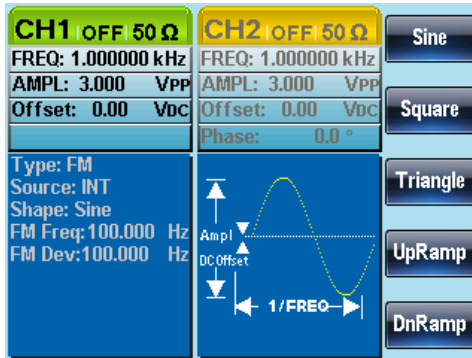

FM Frequency

The frequency of the modulation waveform (FM Frequency) can be set from 2mHz to 20kHz.

Panel Operation 1. Press the MOD key.



2. Press F2 (FM).



3. Press F3 (FM Freq).



- The FM Freq parameter will become highlighted in waveform display panel.

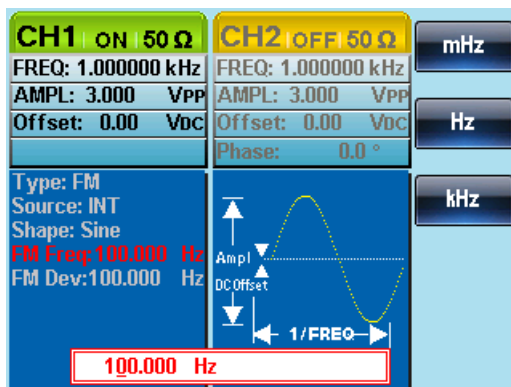

- Use the arrow keys and scroll wheel or number pad to enter the FM frequency.

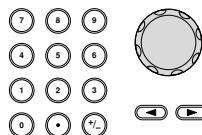



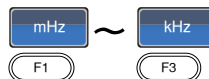

- Press F1~F3 to select the frequency unit.



Range	Modulation frequency	2mHz~20kHz
	Default frequency	100Hz

Frequency Deviation

The frequency deviation is the peak frequency deviation from the carrier wave and the modulated wave.

- Panel Operation
1. Press the MOD key. 
 2. Press F2 (FM).  
 3. Press F2 (Freq Dev).  
 4. The Freq Dev parameter will become highlighted in the waveform display panel.

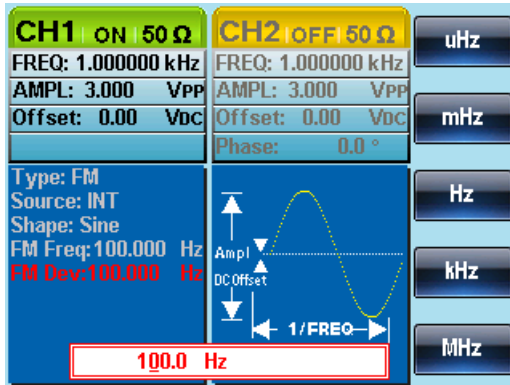

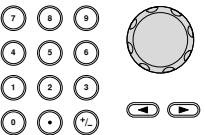
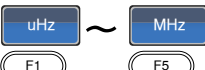









5. Use the arrow keys and scroll wheel or number pad to enter the frequency deviation. 
6. Press F1~ F5 to choose the frequency units. 

Range	Frequency Deviation	DC~25MHz DC~15MHz(square) DC~1MHz (Ramp)
	Default depth	100Hz

Selecting (FM) Modulation Source

The function generator will accept an internal or external source for FM modulation. The default source is internal.

- Panel Operation
1. Press the MOD key. 
 2. Press F2 (FM).  
 3. Press F1 (Source).  
 4. To select the source, press F1 (Internal) or F2 (External).   
 
 5. Press Return to return to the previous menu. 

External Source Use the MOD INPUT terminal on the rear panel when using an external source.

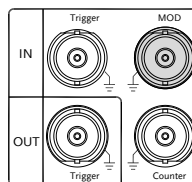

Note

If an external modulating source is selected, the frequency deviation is limited to the $\pm 5V$ MOD INPUT terminal on the rear panel. The frequency deviation is proportional to the signal level of the modulation in voltage. For example, if the modulation in voltage is +5V, then the frequency deviation would be equal to the set frequency deviation. Lower signal levels reduce the frequency deviation while negative voltage levels produce frequency deviations with frequencies below the carrier waveform.

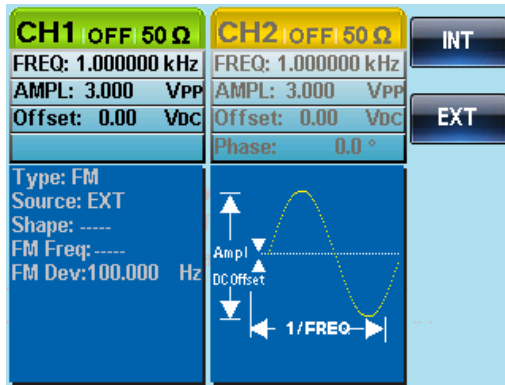

Frequency Shift Keying (FSK) Modulation

Frequency Shift Keying Modulation is used to shift the frequency output of the function generator between two preset frequencies (carrier frequency, hop frequency). The frequency at which the carrier and hop frequency shift is determined by the internal rate generator or the voltage level from the Trigger INPUT terminal on the rear panel.

Only one modulation mode can be used at once. When FSK modulation is enabled, any other modulation modes will be disabled. Sweep and Burst also cannot be used with FSK modulation. Enabling FSK will disable Sweep or Burst mode.

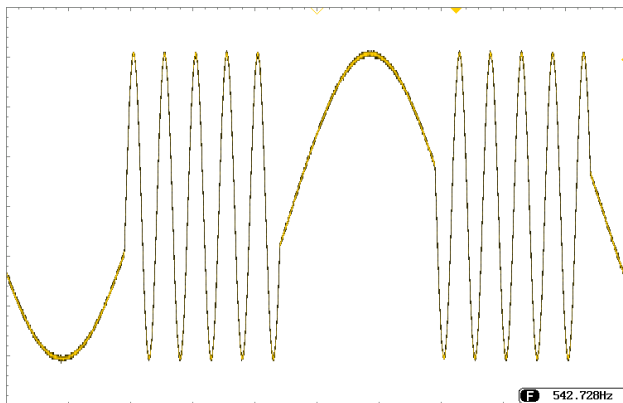

Selecting FSK Modulation

When using FSK mode, the output waveform uses the default settings for carrier frequency, amplitude and offset voltage.

Panel Operation 1. Press the MOD key.



2. Press F3 (FSK).

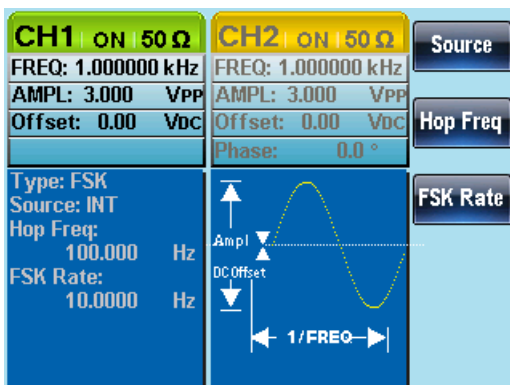

FSK Carrier Shape

Background The default waveform shape is set to sine. Noise waveforms cannot be used as carrier waves.

Panel Operation 1. Press the Waveform key.



2. Press F1~F4 to choose the carrier wave shape.

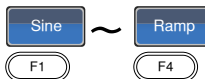

Range Carrier Shape Sine, Square, Pulse, Ramp

FSK Carrier Frequency

The maximum carrier frequency depends on the carrier shape. The default carrier frequency for all carrier shapes is 1kHz. The voltage level of the Trigger INPUT signal controls the output frequency when EXT is selected. When the Trigger INPUT signal is logically low the carrier frequency is output and when the signal is logically high, the hop frequency is output.

Panel Operation 1. Press the **FREQ/Rate** key to select the carrier frequency. 

2. The **FREQ** parameter will become highlighted in the parameter window.

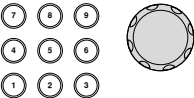

3. Use the arrow keys and scroll wheel or number pad to enter the carrier frequency. 

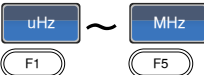
4. Press **F1~F5** to select the FSK frequency units. 

Range	Carrier Shape	Carrier Frequency
	Sine wave	1μHz~25MHz
	Square wave	1μHz~15MHz
	Ramp wave	1μHz~1MHz
	Pulse wave	500μHz~15MHz
	Default frequency	1kHz

FSK Hop Frequency

The default Hop frequency for all waveform shapes is 100 Hz. A square wave with a duty cycle of 50% is used for the internal modulation waveform. The voltage level of the Trigger INPUT signal controls the output frequency when EXT is selected. When the Trigger INPUT signal is logically low the carrier frequency is output and when the signal is logically high, the hop frequency is output.

Panel Operation 1. Press the MOD key.



2. Press F3 (FSK).



3. Press F2 (Hop Freq).



4. The Hop Freq parameter will become highlighted in the Waveform Display area.

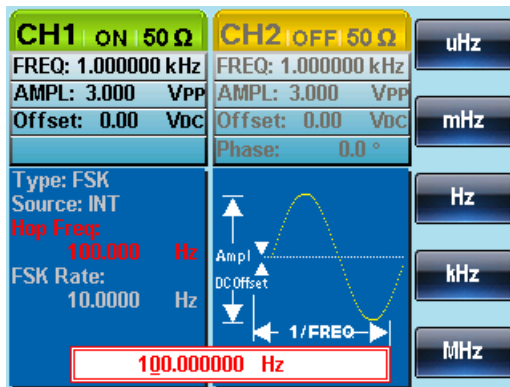

5. Use the arrow keys and scroll wheel or number pad to enter the hop frequency.

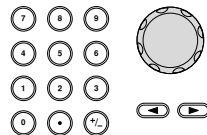

6. Press F1~F5 to select the frequency range.

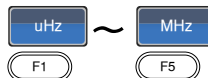

Range	Waveform	Carrier Frequency
	Sine wave	1μHz~25MHz
	Square wave	1μHz~15MHz
	Ramp wave	1μHz~1MHz
	Pulse wave	500μHz~15MHz
	Default frequency	100Hz

FSK Rate

FSK Rate function is used to determine rate at which the output frequency changes between the carrier and hop frequencies. The FSK Rate function only applies to internal FSK sources.

- Panel Operation 1. Select the MOD key.



2. Press F3 (FSK).



3. Press F3 (FSK Rate).



4. The FSK Rate parameter will become highlighted in the waveform display area.

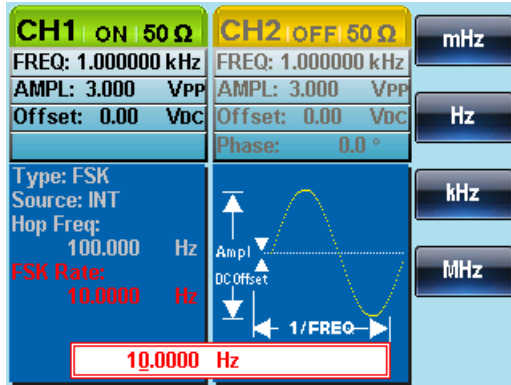

5. The arrow keys and scroll wheel or number pad to enter the FSK rate.

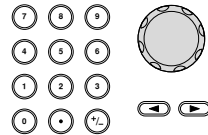

6. Press F1~F4 to select the frequency unit.

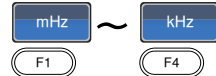











Range	FSK Rate	2mHz~100kHz
	Default	10Hz

Note If an external source is selected, FSK Rate settings are ignored.

FSK Source

The AFG-2225 accepts internal and external FSK sources, with internal as the default source. When the FSK source is set to internal, the FSK rate is configured using the FSK Rate function. When an external source is selected the FSK rate is equal to the frequency of the Trigger INPUT signal on the rear panel.

- Panel Operation
1. Press the MOD key. 
 2. Press F3 (FSK).  
 3. Press F1 (Source).  
 4. Press F1 (Internal) or F2 (External) to select the FSK source.    
 5. Press Return to return to the previous menu. 

Note Note that the Trigger INPUT terminal cannot configure edge polarity.

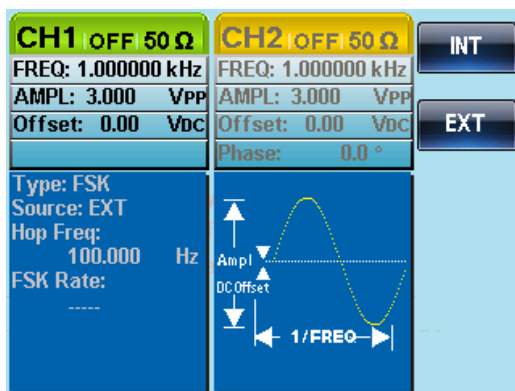

Phase Modulation (PM)

The phase deviation of the carrier waveform deviates from a reference phase value in proportion to changes in the modulating waveform.

Only one mode of modulation can be enabled at any one time. If PM is enabled, any other modulation mode will be disabled. Likewise, burst and sweep modes cannot be used with PM and will be disabled when PM is enabled.

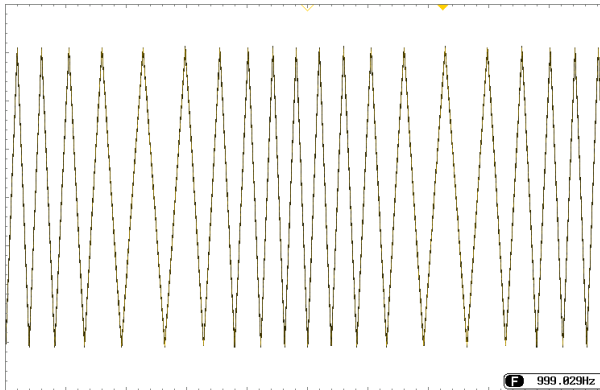

Selecting Phase Modulation (PM)

When selecting PM, the current setting of the carrier frequency, the amplitude modulation frequency, output, and offset voltage must be considered.

Panel Operation 1. Press the MOD key.



2. Press F4 (PM).



The screenshot displays the control panel for two channels, CH1 and CH2, both set to Phase Modulation (PM). The settings are as follows:

Channel	Source	Phase Dev	PM Freq	Shape
CH1	Source	Phase Dev	PM Freq	Shape
CH2	Source	Phase Dev	PM Freq	Shape

Specific parameter values shown in the interface:

- CH1:** ON 50 Ω, FREQ: 1.000000 kHz, AMPL: 3.000 VPP, Offset: 0.00 Vdc
- CH2:** ON 50 Ω, FREQ: 1.000000 kHz, AMPL: 3.000 VPP, Offset: 0.00 Vdc, Phase: 0.0 °
- CH1 Summary:** Type: PM, Source: INT, Shape: Sine, Phase Dev: 180.0 °, PM Freq: 100.000 Hz

The central display shows a sine wave with labels for Amplitude (Ampl), DC Offset, and Period (1/FREQ).

PM Carrier Waveform

Background PM uses a sine wave as default. Noise and Pulse waveform cannot be used with phase modulation.

Panel Operation

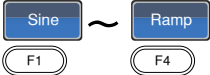
1. Press the Waveform key. 
2. Press F1 ~ F4 to select the waveform. 

Range Carrier Waveform Sine wave, Square wave, ramp wave.

PM Carrier Frequency

Selects the maximum carrier frequency for the carrier waveform. The default carrier frequency is 1kHz.

Panel Operation

1. Press the **FREQ/Rate** key to select the carrier frequency. 
2. The **FREQ** parameter will become highlighted in the parameter window.

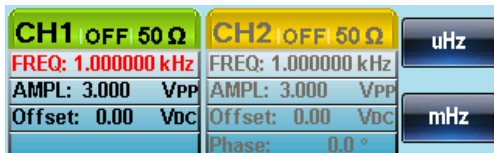

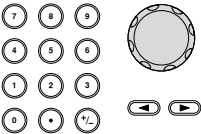
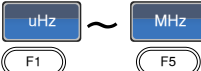









3. Use the arrow keys and scroll wheel or number pad to enter the carrier frequency. 
4. Press F1~F5 to select the frequency unit. 

Range	Carrier Wave	Carrier Frequency
	Sine wave	1μHz~25MH
	Square wave	1μHz~15MHz
	Ramp wave	1μHz~1MHz
	Default frequency	1 kHz

PM Wave Shape

The function generator can accept internal or external sources. The internal sources can include sine, square, triangle, up ramp and down ramp. The default wave shape is sine.

- Panel Operation
- Select the MOD key. 
 - Press F4 (PM).  
 - Press F4 (Shape).  
 - Press F1~F5 to select a waveform shape.    
 - Press Return to return to the previous menu. 

Range	Waveform	
	Square wave	50% Duty Cycle
	Up Ramp	100% Symmetry
	Triangle	50% Symmetry
	Dn Ramp	0% Symmetry

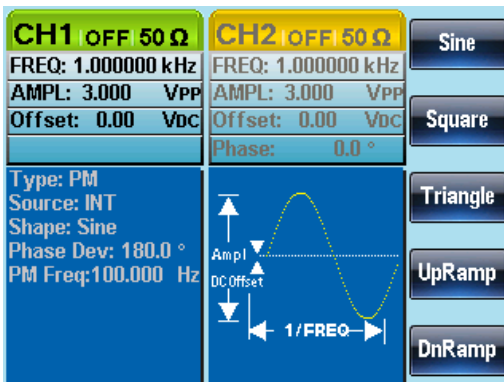

PM Frequency

The frequency of the modulation waveform (PM Frequency) can be set from 2mHz to 20kHz.

Panel Operation 1. Press the MOD key.



2. Press F4 (PM).



3. Press F3 (PM Freq).



4. The PM Freq parameter will become highlighted in the Waveform Display area.

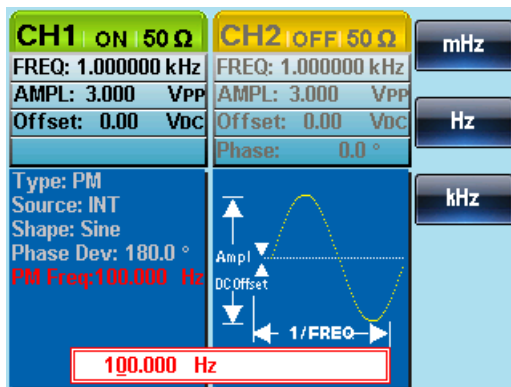

5. Use the arrow keys and scroll wheel or number pad to enter the PM frequency.

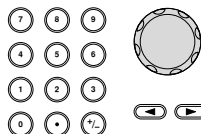





6. Press F1~F3 to select the frequency unit range.





Range	Modulation frequency	2mHz~20kHz
	Default frequency	100Hz

Phase Deviation

The maximum phase deviation depends on the the carrier wave frequency and the modulated waveform.

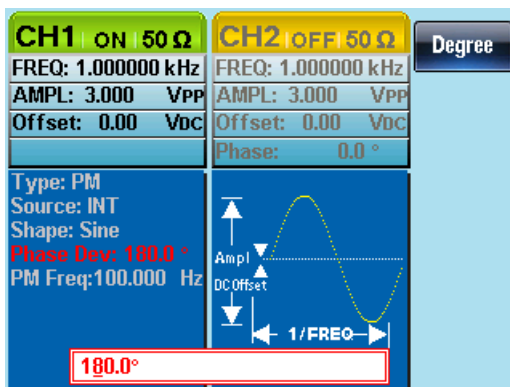
- Panel operation
1. Press the MOD key. 
 2. Press F4 (PM).  
 3. Press F2 (Phase Dev).  
 4. The Phase Dev parameter will become highlighted in the waveform display area.

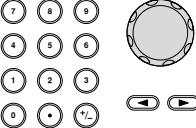











5. Use the arrow keys and scroll wheel or number pad to enter the phase deviation. 
6. Press F1 to select the phase units.  

Range	Phase deviation/shift	0~360°
	Default phase	180°

Select the PM Source

The function generator accepts internal or external sources for phase modulation. The default source is internal.

- Panel Operation
1. Press the MOD key. 
 2. Press F4 (PM).  
 3. Press F1 (Source).  
 4. Press F1 (INT) or F2 (EXT) to select the source.    
 5. Press return to return to the previous menu. 

External Source Use the MOD INPUT terminal on the rear panel when using an external source.

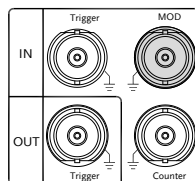

Note If the modulation source is set to external, the phase deviation is controlled by the $\pm 5V$ MOD INPUT terminal on the rear panel. For example, if the modulation voltage is +5V, then the phase deviation is equal to the phase deviation setting. If the modulation voltage is less than +5V, then the phase deviation will be less than the phase deviation setting.

CH1 OFF 50 Ω	CH2 OFF 50 Ω	INT
FREQ: 1.000000 kHz	FREQ: 1.000000 kHz	EXT
AMPL: 3.000 VPP	AMPL: 3.000 VPP	
Offset: 0.00 Vdc	Offset: 0.00 Vdc	
Phase: 0.0 °		
Type: PM Source: EXT Shape: ---- Phase Dev: 180.0 ° PM Freq: ----		
		

SUM modulation

Sum modulation adds a modulating signal to a carrier wave. Typically, sum modulation is used to add noise to a carrier wave. The modulating signal is added as a percentage of the carrier amplitude.

If SUM is enabled, any other modulation mode will be disabled. Likewise, burst and sweep modes cannot be used with SUM and will be disabled when SUM is enabled.

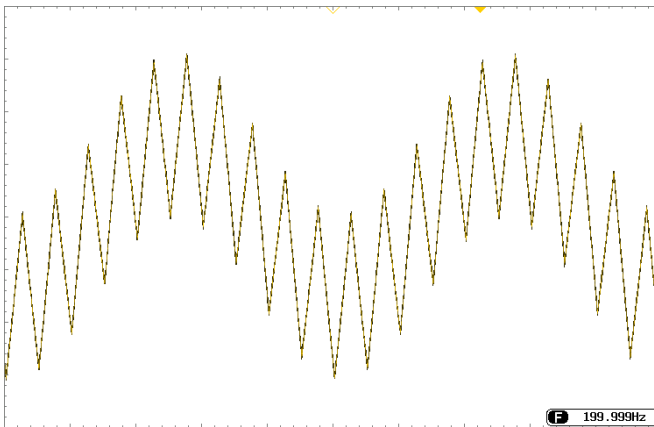

Selecting SUM modulation

For SUM modulation, the modulated waveform amplitude and offset is determined by the carrier wave.

Panel Operation 1. Press the MOD key.



2. Press F5 (SUM).

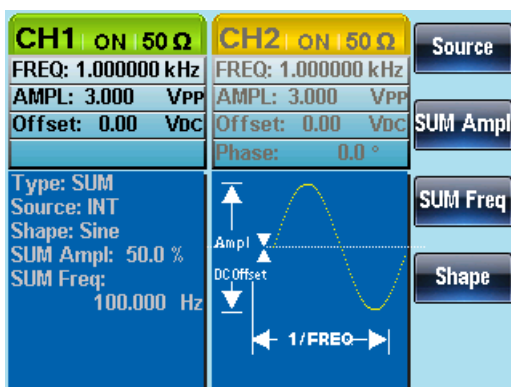

SUM Carrier Waveform

Background

The SUM carrier waveform is a sinewave by default.

Panel Operation 1. Press the Waveform key.



2. Press F1~F5 to select the carrier waveform.

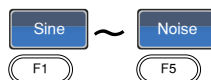

Range

Carrier Waveform

Sine, square, pulse, ramp and noise wave.

SUM Carrier Frequency

The maximum carrier frequency depends on the selected carrier waveform. The default carrier frequency is 1kHz.

Panel Operation 1. Press the **FREQ/Rate** key to select the carrier frequency.



2. The **FREQ** parameter will become highlighted in the parameter window.



3. Use the arrow keys and scroll wheel or number pad to enter the frequency.

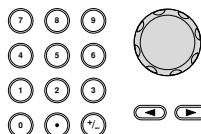



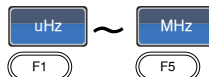







4. Press **F1 ~ F5** to select the frequency units.



Range	Carrier Waveform	Carrier Frequency
	Sine wave	1μHz~25MH
	Square wave	1μHz~25MHz
	Pulse wave	500μHz~25MHz
	Ramp wave	1μHz~1MHz
	Default frequency	1 kHz

SUM Waveform

The function generator can accept internal and external sources. The AFG-2225 includes sine, square, triangle, UpRamp and DnRamp as internal sources. The default waveform is sine.



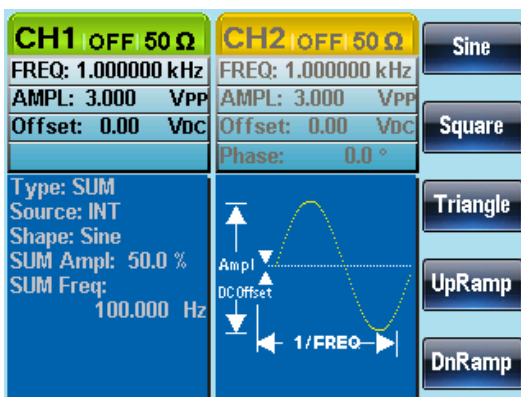

- Panel Operation
1. Press the MOD key. 
 2. Press F5 (SUM).  
 3. Press F4 (Shape).  
 4. Press F1~F5 to select the source waveform.    
 5. Press Return to return to the previous menu. 

Range	Square wave	50% Duty cycle
	Up ramp	100% Symmetry
	Triangle	50% Symmetry
	Down ramp	0% Symmetry





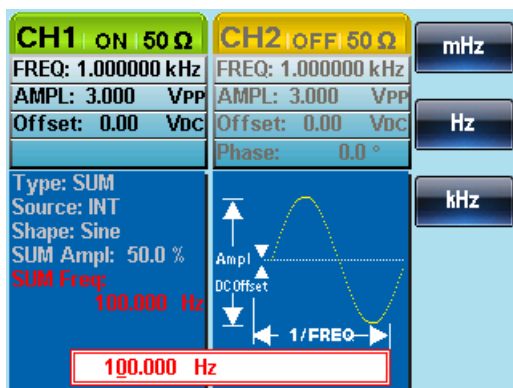

Modulating Waveform Frequency

The frequency of the modulating waveform (SUM Frequency) can be set from 2mHz to 20kHz.

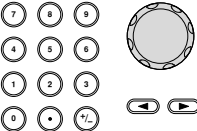
- Panel Operation
1. Press the MOD key. 
 2. Press F5 (SUM).  
 3. Press F3 (SUM Freq).  
 4. The SUM Freq parameter will become highlighted in the waveform display area.







5. Use the arrow keys and scroll wheel or number pad to enter the SUM frequency. 
6. Press F1~F3 to select the frequency units.    



Range	Modulating range	2mHz~20kHz
	Default frequency	100Hz

SUM Amplitude

The SUM amplitude is the offset (in percent relative to the carrier) of the signal that is added to the carrier.

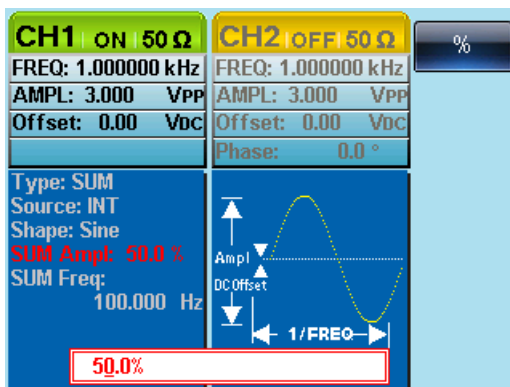
- Panel Operation
1. Press the MOD key. 
 2. Press F5 (SUM).  
 3. Press F2 (SUM Ampl).  
 4. In the waveform display area, the SUM Ampl will be highlighted.

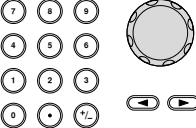











5. Use the arrow keys and scroll wheel or number pad to enter the SUM amplitude. 
6. Press F1 to select the percentage unit.  

Range	Sum amplitude	0~100%
	Default amplitude	50%

Select the SUM Amplitude Source

The signal generator can accept internal or external sources for the SUM amplitude modulation.

- | | | |
|-----------------|---|--|
| Panel Operation | 1. Press the MOD key. |  |
| | 2. Press F5 (SUM). |   |
| | 3. Press F1 (Source). |   |
| | 4. Press F1 (INT) or F2 (EXT) to select the source. |   
  |
| | 5. Press Return to return to the previous menu. |  |

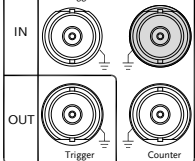
External Source	Use the MOD INPUT terminal on the rear panel when using an external source.	
-----------------	---	---

Note If an external modulation source is selected, the SUM amplitude is controlled by the $\pm 5V$ from the MOD INPUT terminal on the rear panel. For example, if the SUM amplitude is set to 50%, then the maximum amplitude (150% of the carrier) will be at +5V, and the minimum amplitude (50% of the carrier) will be at -5V.

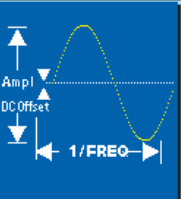
CH1 OFF 50 Ω	CH2 OFF 50 Ω	INT
FREQ: 1.000000 kHz	FREQ: 1.000000 kHz	EXT
AMPL: 3.000 VPP	AMPL: 3.000 VPP	
Offset: 0.00 VDC	Offset: 0.00 VDC	
	Phase: 0.0 °	
Type: SUM Source: EXT Shape: ---- SUM Ampl: 50.0 % SUM Freq: ----		

Frequency Sweep

The function generator can perform a sweep for sine, square or ramp waveforms, but not noise, and pulse. When Sweep mode is enabled, Burst or any other modulation modes will be disabled. When sweep is enabled, burst mode is automatically disabled.

In Sweep mode the function generator will sweep from a start frequency to a stop frequency over a number of designated steps. The step spacing of the sweep can linear or logarithmic. The function generator can also sweep up or sweep down in frequency. If manual or external sources are used, the function generator can be used to output a single sweep.

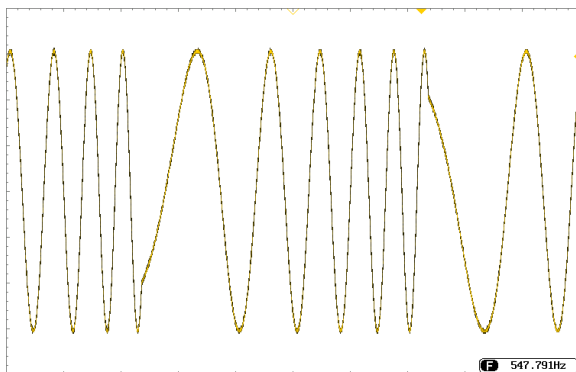

Selecting Sweep Mode

The Sweep button is used to output a sweep. If no settings have been configured, the default settings for output amplitude, offset and frequency are used.



Setting Start and Stop Frequency

The start and stop frequencies define the upper and lower sweep limits. The function generator will sweep from the start through to the stop frequency and cycle back to the start frequency. The sweep is phase continuous over the full range sweep range (1 μ Hz-25MHz).

Panel Operation 1. Press the SWEEP key.



2. Press F3 (Start) or F4 (Stop) to select the start or stop frequency.

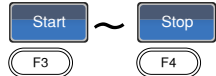

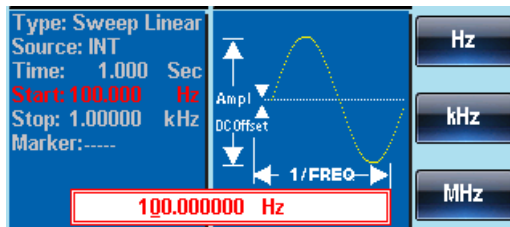

3. The Start or Stop parameter will become highlighted in the waveform display area.

Start

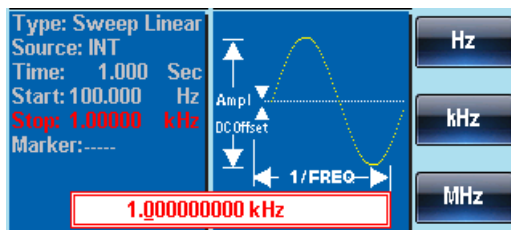

Stop

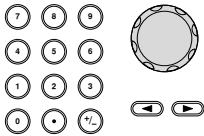

4. Use the arrow keys and scroll wheel or number pad to enter the Stop/Start frequency.
 
5. Press F1~F5 to select the Start/Stop frequency units.
 

Range	Sweep Range	1μHz~25MHz (Sine wave) 1μHz~1MHz (Ramp wave) 1μHz~15MHz (Square wave)
	Start - Default	100Hz
	Stop - Default	1kHz

Note

To sweep from low to high frequencies, set the start frequency less than the stop frequency.

To sweep from high to low frequencies, set the start frequency greater than the stop frequency.

When marker is off, the SYNC signal is a square wave with a duty cycle of 50%. At the start of the sweep, the SYNC signal is at a TTL low level that rises to a TTL high level at the frequency midpoint. The frequency of the SYNC signal is equal to the sweep time.

When marker is on, at the start of the sweep, the SYNC signal is at a TTL high level that drops to a TTL low level at the marker. The SYNC signal is output from the mark output terminal.

Center Frequency and Span

A center frequency and span can be set to determine the upper and lower sweep limits (start/stop).

Panel Operation

1. Press the SWEEP key.



2. Press F5 (More).



3. Press F2 (Span) or F3 (Center) to select the span or center.

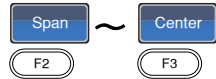

4. The Span or Center parameters will become highlighted in the waveform display area.

Span

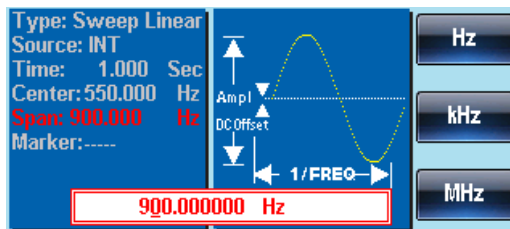

Center

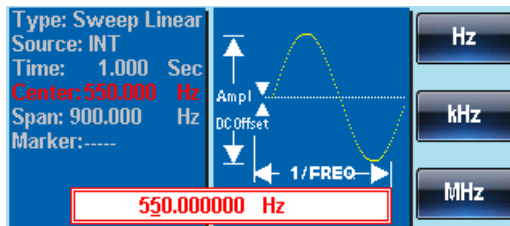

5. Use the arrow keys and scroll wheel or number pad to enter the Span/Center frequency.

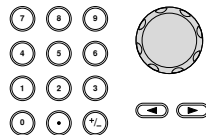

6. Press F1~F5 to select the Start/Stop frequency units.

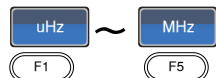

Range	Center frequency	1 μ Hz~25MHz (sine wave) 1 μ Hz~1MHz (Ramp wave) 1 μ Hz~15MHz (square wave)
	Span frequency	DC~25MHz (sine wave) DC ~1MHz (Ramp wave) 1 μ Hz~15MHz (square wave)
	Default center	550Hz
	Default span	900Hz

Note

To sweep from low to high frequencies, set a positive span.









To sweep from high to low frequencies, set a negative span.

When marker is off, the SYNC signal is a square wave with a duty cycle of 50%. At the start of the sweep, the SYNC signal is at a TTL low level that rises to a TTL high level at the frequency midpoint. The frequency of the SYNC signal is equal to the sweep time.

When marker is on, at the start of the sweep, the SYNC signal is at a TTL high level that drops to a TTL low level at the marker. The SYNC signal is output from the mark output terminal.

Sweep Mode

Sweep mode is used to select between linear or logarithmic sweeping. Linear sweeping is the default setting.

- Panel Operation
1. Press the SWEEP key. 
 2. Press F2 (Type).  
 3. To select linear or logarithmic sweep, press F1 (Linear) or F2 (Log).    
 4. Press Return to return to the previous menu. 

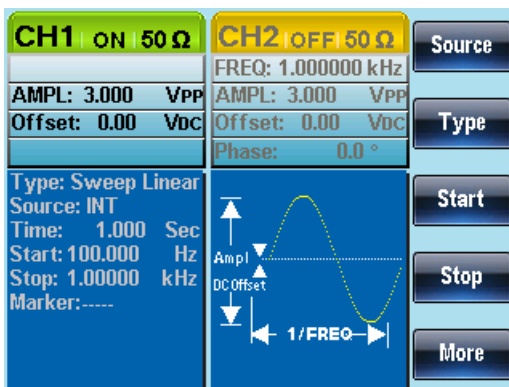

Sweep Time

The sweep time is used to determine how long it takes to perform a sweep from the start to stop frequencies. The function generator automatically determines the number of discrete frequencies used in the scan depending on the length of the scan.

Panel Operation 1. Press the SWEEP key.



2. Press F5 (More).



3. Press F1 (SWP Time).



4. The Time parameter will become highlighted in the waveform display area.

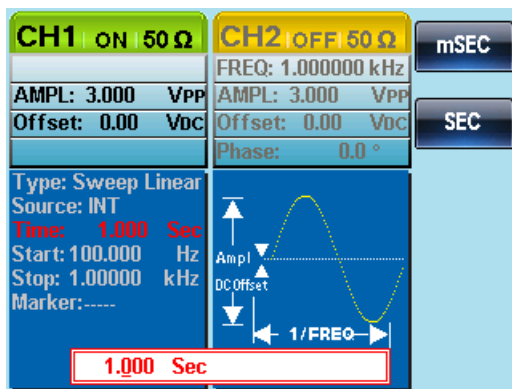

5. Use the selector keys and scroll wheel or number pad to enter the Sweep time.

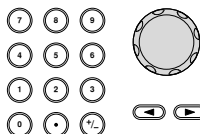









6. Press F1~F2 to select the time unit.



Range	Sweep time	1ms ~ 500s
	Default time	1s

Marker Frequency

The marker frequency is the frequency at which the marker signal goes low (The marker signal is high at the start of each sweep). The marker signal is output from the Trigger OUT terminal on the rear panel. The default is 550 Hz.

- Panel Operation
1. Press the SWEEP key. 
 2. Press F5 (More).  
 3. Press F4 (Marker).  
 4. Press F2 (ON/OFF) to toggle the marker on or off.  
 5. Press F1 (Freq) to select the marker frequency.  
 6. The Marker parameter will become highlighted in the waveform display area.

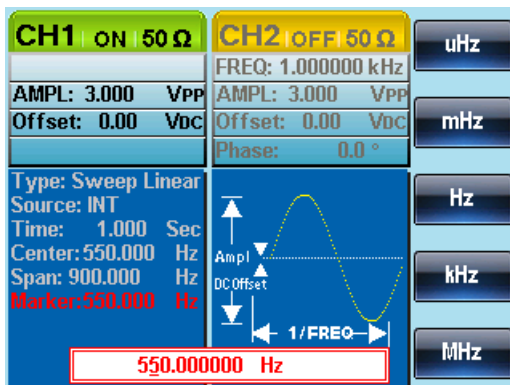

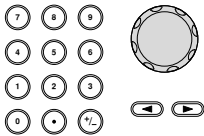
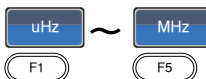
7. Use the arrow keys and scroll wheel or number pad to enter the frequency. 
8. Press F1~F5 to select the frequency unit. 



Range	Frequency	1μHz~25MHz (Sine wave) 1μHz~1MHz (Ramp wave) 1μHz~15MHz square wave)
	Default	550Hz

Note The marker frequency must be set to a value between the start and stop frequencies. If no value is set, the marker frequency is set to the average of the start and stop frequencies.

Marker mode will override SYNC mode settings when sweep mode is active.

Sweep Trigger Source

In sweep mode the function generator will sweep each time a trigger signal is received. After a sweep output has completed, the function generator outputs the start frequency and waits for a trigger signal before completing the sweep. The default trigger source is internal.

- Panel Operation**
1. Press the SWEEP key. 
 2. Press F1 (Source). 

3. To select the trigger source, press F1 (Internal), F2 (External) or F3 (Manual).

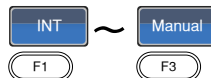

4. Press Return to return to the previous menu.



Note

Using the Internal source will produce a continuous sweep using the sweep time settings.

With an external source, a sweep is output each time a trigger pulse (TTL) is received from the Trigger IN terminal on the rear panel.

The trigger period must be equal to or greater than the sweep time plus 1ms.

5. If manual is selected, press F1 (Trigger) to manually start each sweep.



CH1 OFF 50 Ω	CH2 OFF 50 Ω	Source
AMPL: 3.000 VPP	FREQ: 1.000000 kHz	Type
Offset: 0.00 Vdc	AMPL: 3.000 VPP	Start
Type: Sweep Linear	Offset: 0.00 Vdc	Stop
Source: INT	Phase: 0.0 °	More
Time: 1.000 Sec		
Start: 100.000 Hz		
Stop: 1.00000 kHz		
Marker: ----		
Trigger Out: Rise		

Burst Mode

The function generator can create a waveform burst with a designated number of cycles. Burst mode supports sine, square and ramp waveforms.

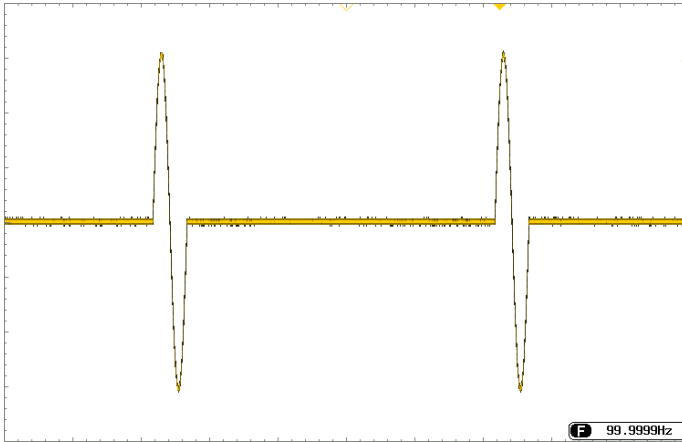

Selecting Burst Mode

When burst mode is selected, any modulation or sweep modes will be automatically disabled. If no settings have been configured, the default settings for output amplitude, offset and frequency are used.



Burst Modes

Burst mode can be configured using Triggered (N Cycle mode) or Gated mode. Using N Cycle/Triggered mode, each time the function generator receives a trigger, the function generator will output a specified number of waveform cycles (burst). After the burst, the function generator will wait for the next trigger before outputting another burst. N Cycle is the default Burst mode. Triggered mode can use internal or external triggers.

The alternative to using a specified number of cycles, Gated mode uses the external trigger to turn on or off the output. When the Trigger INPUT signal is high, waveforms are continuously output. When the Trigger INPUT signal goes low, the waveforms will stop being output after the last waveform completes its period. The voltage level of the output will remain equal to the starting phase of the burst waveforms, ready for the signal to go high again.

Burst Mode	Burst Count	Burst Period	Phase	Trigger Source
Triggered (Int)	Available	Available	Available	Immediate
Triggered (Ext)	Available	Not used	Available	EXT, Bus
Gated pulse (Ext)	Not used	Not used	Available	Unused

In Gated mode, burst count, burst cycle and trigger source are ignored. If a trigger is input, then the trigger will be ignored and will not generate any errors.

Panel Operation 1. Press the Burst key.



2. To select either N Cycle (F1) or Gate (F2).

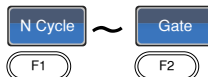

Burst Frequency

In the N Cycle and Gated modes, the waveform frequency sets the repetition rate of the burst waveforms. In N-Cycle mode, the burst is output at the waveform frequency for the number of cycles set. In Gated mode the waveform frequency is output while the trigger is high. Burst mode supports sine, square or ramp waveforms.

Panel Operation 1. Press the **FREQ/Rate** key.



2. The **FREQ** parameter will become highlighted in the parameter window.



3. Use the arrow keys and scroll wheel or number pad to enter the frequency.

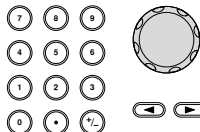

4. Press F1~F5 to select the frequency unit.

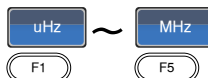





Range	Frequency	1uHz~25MHz
	Frequency – Ramp	1uHz~1MHz
	Default	1kHz

Note Waveform frequency and burst period are not the same. The burst period is the time between the bursts in N-Cycle mode.

Burst Cycle/Burst Count

The burst cycle (burst count) is used to define the number of cycles that are output for a burst waveform. Burst cycle is only used with N-cycle mode (internal, external or manual source). The default burst cycle is 1.

- Panel Operation
1. Press the Burst key. 
 2. Press F1 (N Cycle).  
 3. Press F1 (Cycles).  
 4. The Cycles parameter will become highlighted in the Waveform Display area.

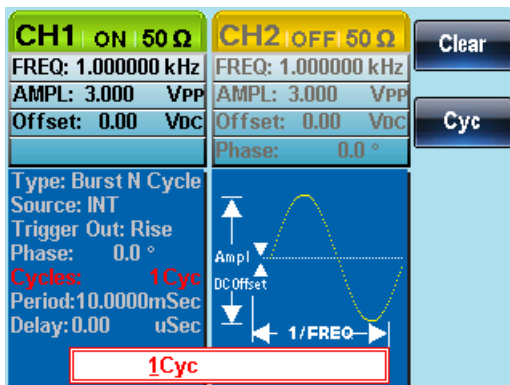

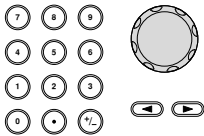
- 5. Use the arrow keys and scroll wheel or number pad to enter the number of cycles.
 

- 6. Press F2 to select the Cyc unit.
 

Range	Cycles	1~65535
-------	--------	---------

Note Burst cycles are continuously output when the internal trigger is selected. The burst period determines the rate of bursts and the time between bursts.

Burst cycle must be less than the product of the burst period and wave frequency.

$$\text{Burst Cycle} < (\text{Burst Period} \times \text{Wave Frequency})$$

If the burst cycle exceeds the above conditions, the burst period will be automatically increased to satisfy the above conditions.

If gated burst mode is selected, burst cycle is ignored. Though, if the burst cycle is changed remotely whilst in gated mode, the new burst cycle is remembered when used next.

Infinite Burst Count

- Panel Operation
1. Press the Burst key. Burst
 2. Press F1 (N Cycle). N Cycle F1
 3. Press F2 (Infinite). Infinite F2

Note Infinite burst is only available when using manual triggering.

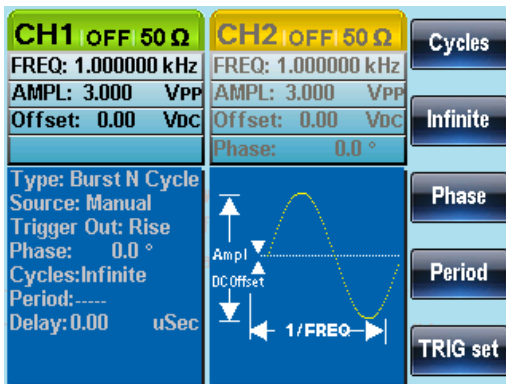

Burst Period

The burst period is used to determine the time between the start of one burst and the start of the next burst. It is only used for internally triggered bursts.

- Panel Operation
1. Press the Burst key. Burst
 2. Press F1 (N Cycle). N Cycle F1

3. Press F4 (Period).



4. The Period parameter will become highlighted in the Waveform Display area.

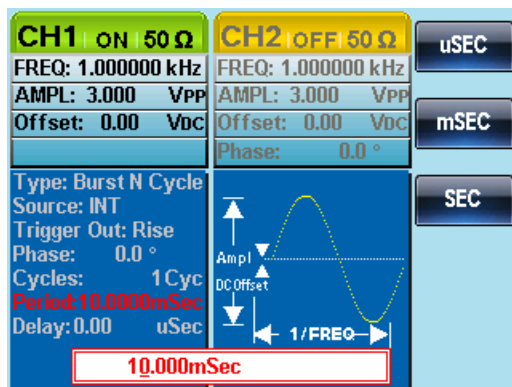

5. Use the arrow keys and scroll wheel or number pad to enter period time.

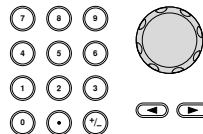

6. Press F1~F3 to choose the period time unit.



Range	Period time	1ms~500s
	Default	10ms

Note





Burst period is only applicable for internal triggers. Burst period settings are ignored when using gated burst mode or for external and manual triggers.

The burst period must be large enough to satisfied the condition below:



Burst Period > Burst Count / Wave frequency + 200ns.

Burst Phase

Burst Phase defines the starting phase of the burst waveform. The default is 0°.

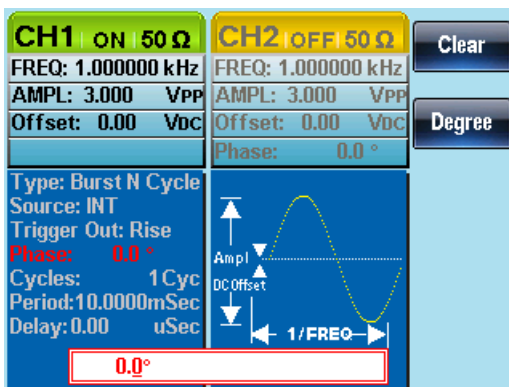
- Panel Operation
1. Press the Burst key. 
 2. Press F1 (N Cycle).  
 3. Press F3 (Phase).  
 4. The Phase parameter will become highlighted in the Waveform Display area.

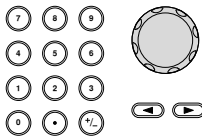

5. Use the arrow keys and scroll wheel or number pad to enter the phase. 
6. Press F2 (Degree) to select the phase unit.  

Range	Phase	-360° ~ +360°
	Default	0°









Note When using sine, square, triangle or ramp waveforms, 0° is the point where the waveforms are at zero volts.

0° is the starting point of a waveform. For sine, square or Triangle, Ramp waveforms, 0° is at 0 volts (assuming there is no DC offset).

Burst Phase is used for both N cycle and Gated burst modes. In gated burst mode, when the Trigger INPUT signal goes low the output is stopped after the current waveform is finished. The voltage output level will remain equal to the voltage at the starting burst phase.

Burst Trigger Source

Each time the function generator receives a trigger in triggered burst (N-Cycle) mode, a waveform burst is output. The number of waveforms in each burst is designated by the burst cycle (burst count). When a burst has completed, the function generator waits for the next trigger. Internal source is the default triggered burst (N-cycle) mode on power up.

- | | | |
|-----------------|---|--|
| Panel Operation | 1. Press the Burst key. |  |
| | 2. Press F1 (N Cycle). |   |
| | 3. Press F5 (TRIG set). |   |
| | 4. Choose a trigger type by pressing F1 (INT), F2 (EXT) or F3 (Manual). |  ~ 
  |

Manual Triggering

If a manual source is selected, the Trigger softkey (F1) must be pressed each time to output a burst.

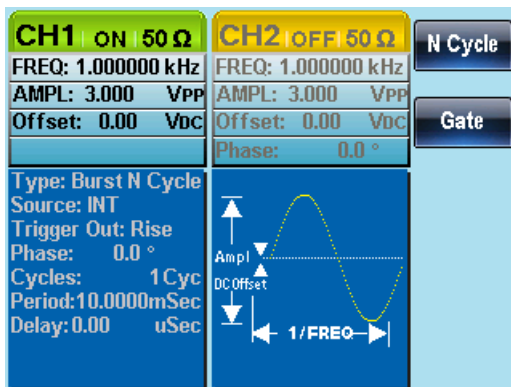

Note







When the internal trigger source is chosen, the burst is output continuously at a rate defined by the burst period setting. The interval between bursts is defined by the burst period.

When the external trigger is selected the function generator will receive a trigger signal (TTL) from the Trigger INPUT terminal on the rear panel. Each time the trigger is received, a burst is output (with the defined number of cycles). If a trigger signal is received during a burst, it is ignored.

When using the manual or external trigger only the burst phase and burst cycle/count are applicable, the burst period is not used.

A time delay can be inserted after each trigger, before the start of a burst.

Burst Delay

- Panel Operation
1. Press the Burst key. 
 2. Press F1 (N Cycle).  
 3. Press F5 (TRIG set).  
 4. Press F4 (Delay).  
 5. The Delay parameter will become highlighted in the Waveform Display area.

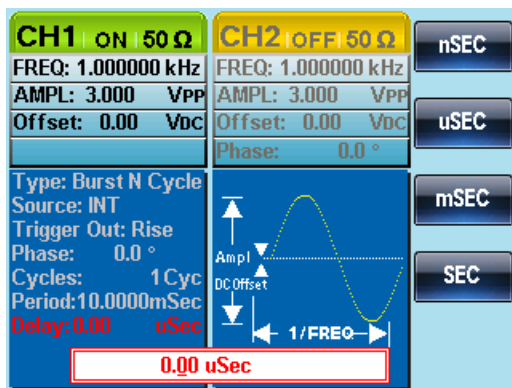

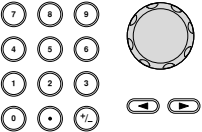
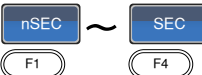











6. Use the selector keys and scroll wheel or number pad to enter period time. 
7. Press F1~F4 to choose the delay time unit. 

Range	Delay time	0s~655350nS
	Default	0s

Burst Trigger Output

The Trig Out terminal on the rear panel can be used for burst or sweep modes to output a rising edge TTL compatible trigger signal. By default the trigger signal is rising edge. The trigger signal is output at the start of each burst.

- Panel Operation
1. Press the Burst key. 
 2. Press F1 (N Cycle).  
 3. Press F5 (TRIG set).  
 4. Press F5 (TRIG out).  
 5. Press F3 (ON/OFF) to toggle Trigger out ON/OFF.  
 6. Select F1 (Rise) or F2 (Fall) edge trigger.    

Note When the internal trigger is selected, a square wave with a 50% duty cycle is output at the beginning of each burst.

Trig Out cannot be used with manual triggering and will be disabled if manual triggering is set.

For manual triggering, a pulse is output (>1us) from the Trig Out connector at the start of each burst.

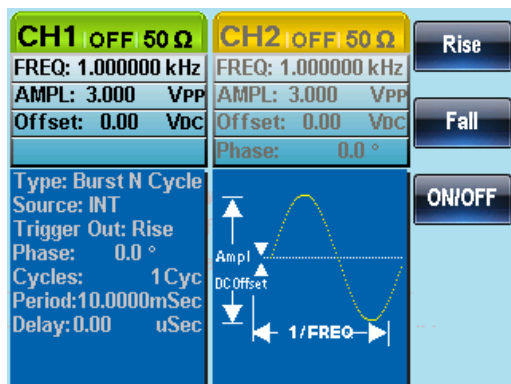

SECONDARY SYSTEM **FUNCTION SETTINGS**

The secondary system functions are used to store and recall settings, view help files, view the software version, update the firmware, set the buzzer.

Save and Recall	132
System and Settings	136
System and Settings	136
Viewing and Updating the Firmware	136
Setting the Buzzer Sound	137

Save and Recall

The AFG-2225 has non-volatile memory to store instrument state and ARB data. There are 10 memory files numbered 0~9. Each memory file can either store arbitrary waveform data (ARB), settings or both. When data (ARB or Setting data) is stored in a memory file, the data will be shown in red. If a file has no data, it will be shown in blue.

Save/Recall Properties	ARB
	<ul style="list-style-type: none"> • Rate • Frequency • Length • Display horizontal
	Setting
	<ul style="list-style-type: none"> • Functions <ul style="list-style-type: none"> • Waveform • Frequency • Pulse Width • Square wave Duty • Ramp Symmetry • Amplitude • Amplitude unit • Offset • Modulation type • Beep setting • Impedance • Main output • Sweep <ul style="list-style-type: none"> • Source • Type • Marker
	<ul style="list-style-type: none"> • Display vertical • Output Start • Output length
	<ul style="list-style-type: none"> • AM <ul style="list-style-type: none"> • Source • Shape • Depth • AM frequency • FM <ul style="list-style-type: none"> • Source • Shape • Deviation • FM frequency • FSK <ul style="list-style-type: none"> • Source • Shape • Rate • Hop frequency • PM <ul style="list-style-type: none"> • Source

- Time
- Start frequency
- Stop frequency
- Center frequency
- Span frequency
- Marker frequency
- Shape
- Phase deviation
- Frequency
- Burst Type
- Source
- Trigger out
- Type
- Cycles
- Phase
- Period
- Delay

Panel Operation 1. Press the UTIL key.



2. Press F1 (Memory).



3. Use the scroll wheel to highlight a memory file number.

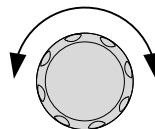

4. Choose a file operation:

Press F1 to store a file, press F2 to recall a file, or press F3 to delete a file.

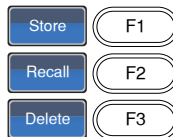

5. Use the scroll wheel to highlight the data type.

ARB, Setting or ARB+Setting

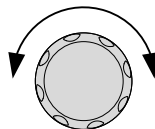

6. Press F5 (Done) to choose the data type.



Range	Memory file	Memory0 ~ Memory9
	Data type	ARB, Setting, ARB+Setting

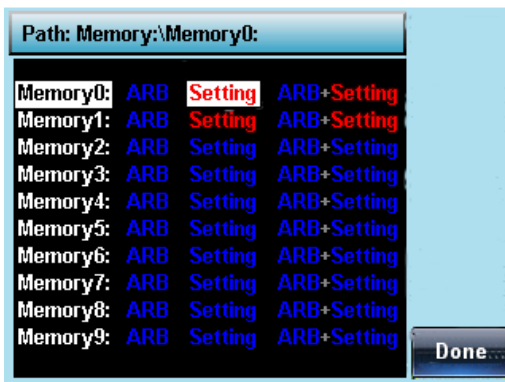

7. Press F5 (Done) to confirm the operation.



Delete All

8. To delete all the files for Memory0~Memory9, press F4.



9. Press F1 (Done) to confirm the deletion of all files.



System and Settings

There are a number of miscellaneous settings and firmware settings that can be configured.

Viewing and Updating the Firmware

View Version

1. Press the UTIL key.



2. Press F2 (Cal.).



3. Press F2 (Software).



4. Press F1 (Version) to view the firmware version.



The version information will be shown on screen:
Instrument, Version, FPGA Revision

Update Firmware

5. To update the firmware, insert a USB flash drive with a firmware file in the USB host drive. Press F2 (Upgrade).











Note

The firmware file (*.bin) must be located in a directory, directly off the USB root directory.



Setting the Buzzer Sound

Background Turns the beeper on or off.

- Panel Operation
1. Press the UTIL key. 
 2. Press F3 (System).  
 3. Press F3 (Beep) to toggle the buzzer sound on or off.  
 4. Press F1(ON) or Press F2(OFF)    



Frequency Counter

Example: Turn on the frequency counter. Gate time: 1 second.

- Output: N/A
1. Press UTIL, F5 (Counter).  

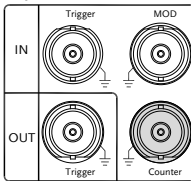
Input:





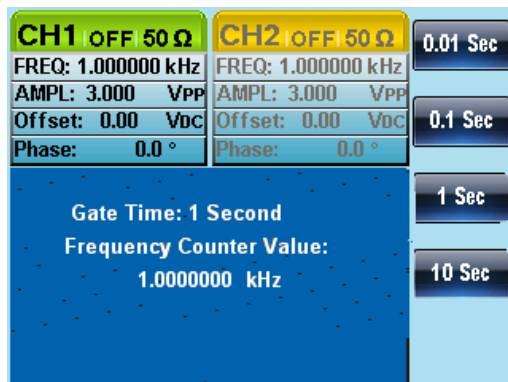

2. Press F1 (Gate Time), and press F3 (1 Sec) to choose a gate time of 1 second.  
3. Connect the signal of interest to the Frequency counter input on the rear panel.
4. Input a 1kHz square wave signal into the Counter input on the rear panel. Set the gate time to 1S.



Frequency Coupling

Example: Frequency Coupling

1. Press UTIL, F4 (Dual Chan) to enter the coupling function.  
2. Press F1 (Freq Cpl) to select the frequency coupling function. 
3. Press F2 (Offset). The offset is the frequency difference between CH1 and CH2. Use the number keys or scroll wheel to enter the offset. 

There are two different coupling modes. They are calculated as follows:

$$\text{Offset} = \text{CH2} - \text{CH1}$$

$$\text{Ratio} = \text{CH2} / \text{CH1}$$

4. Input an offset value of 1kHz.
Press F1~ F5 to select the units.

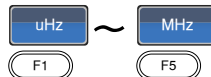

The frequency of channel 2 becomes 2kHz (CH2=CH1 + Offset).

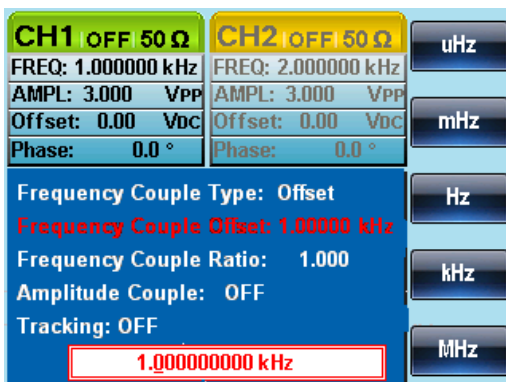



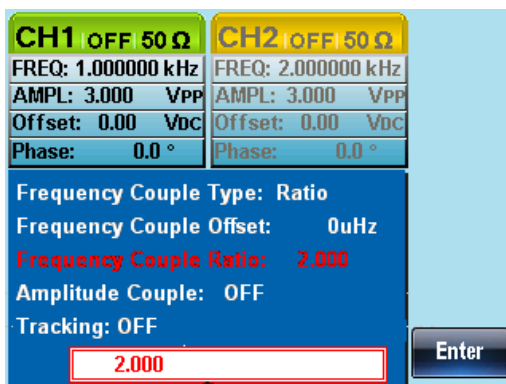

5. Change the frequency coupling mode to Ratio.
Set the ratio to 2.

The frequency of CH2 automatically changes accordingly to match the ratio (CH2=CH1*Ratio).



Amplitude Coupling



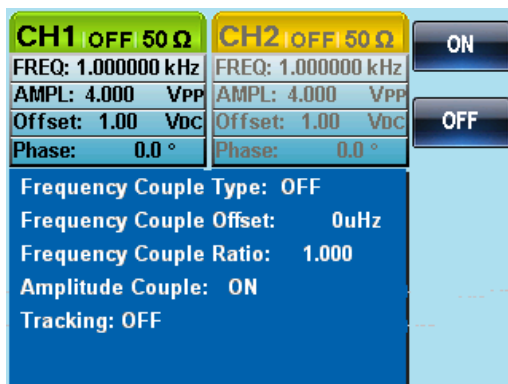

Example: Amplitude Coupling

1. The following assumes that the amplitude has already been set to 4Vpp with a DC offset of 1Vdc.
2. Press UTIL, F4 (Dual Chan) to enter the coupling function.
 

3. Press F2 (Ampl Cpl), F1 (ON) to select the amplitude coupling function.
 

4. The amplitude and offset between both channel is coupled. Any changes in amplitude in the current channel is reflected in the other channel.



Tracking

Example: Tracking

1. The method for outputting a square wave has been previously described. Use this method to output a 2kHz squarewave from CH1 with an amplitude of 5Vpp and a DC offset of 1Vdc.
2. Press UTIL, F4 (Dual Chan) to enter the coupling function.  
3. Press F3 (Tracking), F2 (On) to turn on the tracking function.  
4. When tracking is turned on, parameters such as amplitude and frequency from the current channel are mirrored on the other channel.

CH1 OFF 50 Ω	CH2 OFF 50 Ω	OFF
FREQ: 2.000000 kHz	FREQ: 2.000000 kHz	ON
AMPL: 5.000 VPP	AMPL: 5.000 VPP	
Offset: 1.00 VDC	Offset: 1.00 VDC	
Phase: 0.0 °	Phase: 0.0 °	
Frequency Couple Type: OFF Frequency Couple Offset: 0uHz Frequency Couple Ratio: 1.000 Amplitude Couple: OFF Tracking: ON		Inverted

CH1 OFF 50 Ω	CH2 OFF 50 Ω	Sine
FREQ: 2.000000 kHz	FREQ: 2.000000 kHz	Square
AMPL: 5.000 VPP	AMPL: 5.000 VPP	
Offset: 1.00 VDC	Offset: 1.00 VDC	
Phase: 0.0 °	Phase: 0.0 °	
Duty: 50.0 %	Duty: 50.0 %	Pulse
		Ramp
		Noise

C CHANNEL SETTINGS

The channel settings chapter shows how to set the output impedance, output phase and DSO connection settings.

Output Impedance	143
Selecting the Output Phase	144
Synchronizing the Phase.....	145
DSO Link	146

Output Impedance

Background The AFG-2225 has selectable output impedances: 50Ω or high impedance. The default output impedance is 50Ω. The output impedances are to be used as a reference only. If the actual load impedance is different to that specified, then the actual amplitude and offset will vary accordingly.

Panel Operation 1. Press the CH1/CH2 key. 

Note The load function can only be used if the ARB, MOD, SWEEP or BURST functions are not active.

2. Press F1 (Load).  

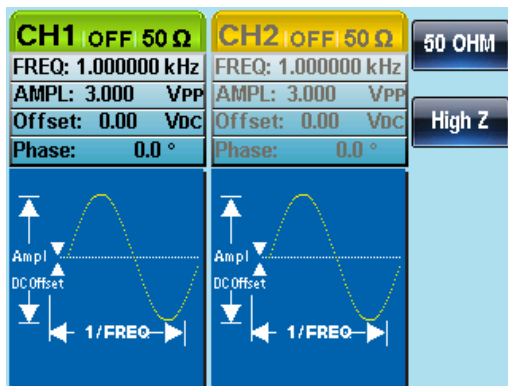

3. Select F1 (50 OHM) or F2 (High Z) to select the output impedance.



Selecting the Output Phase

Panel operation 1. Press the CH1/CH2 key. CH1/CH2

Note The phase function can only be used if the ARB, MOD, SWEEP or BURST functions are not active.

2. Press F4 (Phase) and then press F1 (Phase) Phase F4



3. The Phase parameter in the parameter window will become highlighted.



4. Use the arrow keys and scroll wheel or number pad to enter the output phase.

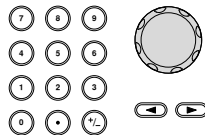



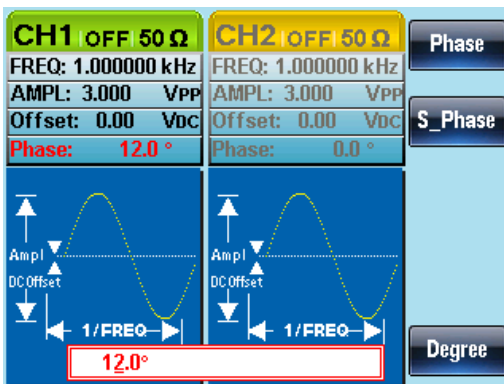

5. Press F5 (Degree).



Synchronizing the Phase

Background Synchronizes both the outputs on the AFG-2225.

- Panel Operation**
1. Press the CH1/CH2 key. 
 2. Press F4 (Phase).  
 3. Press F2 (S_Phase) to synchronize the phase of the channels.  

DSO Link

Background DSO Link enables the AFG-2225 to receive lossless data from a GDS-2000 Series DSO to create ARB data.

1. Connect the AFG-2225 USB host port to the GDS-2000's USB B device port.

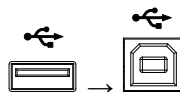

Panel Operation 2. Press the CH1/CH2 key.



3. Press F5 (DSO Link).



4. Press F1 (Search).



5. To select a DSO channel, Press F2 (CH1), F3 (CH2), F4 (CH3) or F5 (CH4). The acquired data can then be displayed.

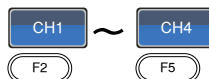

A

ARBITRARY WAVEFORMS



















The AFG-2225 can create user-defined arbitrary waveforms with a sample rate of 120MHz. Each waveform can include up to 4k of data points with a vertical range of ± 511 .

Inserting Built-In Waveforms	148
Create an AbsAtan Waveform	148
Display an Arbitrary Waveform	150
Set the Horizontal Display Range	150
Set the Vertical Display Properties	152
Page Navigation (Back Page)	154
Page Navigation (Next Page)	156
Display	158
Editing an Arbitrary Waveform	159
Adding a Point to an Arbitrary Waveform	159
Adding a Line to an Arbitrary Waveform	160
Copy a Waveform	162
Clear the Waveform	164
ARB Protection	166
Output an Arbitrary Waveform	169
Output Arbitrary Waveform	169
Saving/Loading an Arbitrary Waveform	171
Saving a Waveform to Internal Memory	171
Saving a Waveform to USB Memory	172
Load a Waveform from Internal Memory	175
Load a Waveform from USB	178

Inserting Built-In Waveforms

The AFG-2225 includes 66 common waveforms, such as math waveforms, windowing functions and engineering waveforms.

Create an AbsAtan Waveform

- Panel Operation
1. Press the ARB key. 
 2. Press F3(Built in).  
 3. Press F4(Wave).  
 4. Press F1(Common).  
 5. Use the scroll wheel to select " AbsAtan" from the built-in Common waveforms.
 6. Press F5(Select) to select AbsAtan waveform  
 7. Press F1(Start) and set the start position of the AbsAtan waveform.  
 8. You can also change the length and scale of the waveform by pressing F2(Length) or F3(Scale).  
 
 9. Press F5 (Done) to complete the operation  
 10. Press return to return to the previous menu. 
-

Below an Absatan wave created at start:0, Length: 33,
Scale: 511

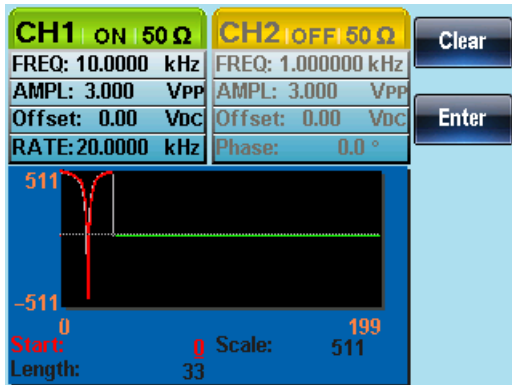





Display an Arbitrary Waveform



Set the Horizontal Display Range

The horizontal window bounds can be set in one of two ways: Using a start point and length, or a center point and length.







Panel Operation

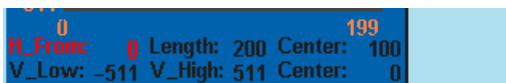

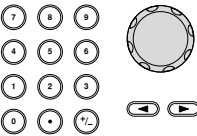
1. Press the ARB key. 
2. Press F1 (Display) to enter the display menu.  
3. Press F1 (Horizon) to enter the horizontal menu.  



Using a Start Point

4. Press F1(Start)  
5. The H_From parameter will become highlighted.



6. Use the arrow keys and scroll wheel or number pad to enter the H_From value. 
7. Press Clear (F1) to cancel.  
8. Press F2 (Enter) to save the settings.  
9. Press Return to return to the previous menu. 

Setting the Length 10. Repeat steps 4~9 for Length  

Using a Center Point 11. Repeat steps 4~9 for Center  

Zoom in 12. To zoom into the arbitrary waveform, press F4 (Zoom In). The Zoom In function will reduce the length by half each time the function is used. The minimum allowable length is 3.



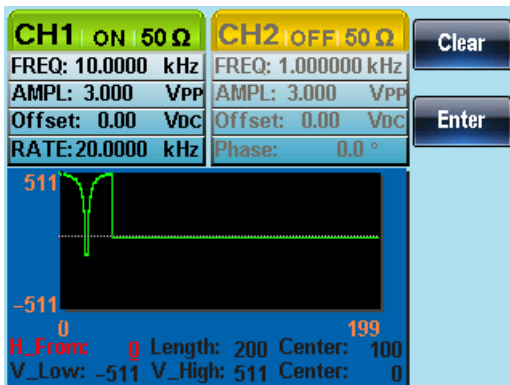

Zoom out 13. To zoom out from the center point of the waveform, press F5 (Zoom out). The Zoom out function will increase the length by 2. The maximum allowable length is 4096.



Below, an arbitrary waveform has a start of 0, length of 200 and is centered at 100.



Set the Vertical Display Properties

Like the horizontal properties, the vertical display properties of the waveform display can be created in two ways: Setting high and low values, or setting the center point.

- Panel Operation
1. Press the ARB key. 
 2. Press F1 (Display).  
 3. Press F2 (Vertical).  

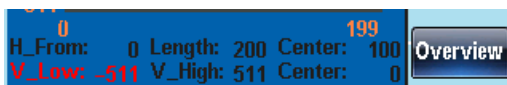

- Setting the Low Point
4. Press F1 (Low).  

5. The V_Low parameter will become highlighted.

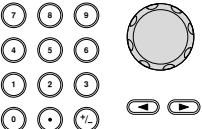



6. Use the arrow keys and scroll wheel or number pad to enter the V_Low value. 

7. Press Clear (F1) to cancel.  

8. Press F2 (Enter) to save the settings.  

9. Press Return to return to the previous menu. 

- Setting the High Point
10. Repeat steps 4~9 for V_High (F2).  

Setting the Center Point 11. Repeat steps 4~9 for Center Point (F3). Center F3

Zoom 12. To zoom in from the center of the arbitrary waveform, press F4 (Zoom in). The Zoom in function will reduce the length by half each time the function is used. The minimum allowable vertical low is -2, and the minimum vertical high is 2. Zoom in F4



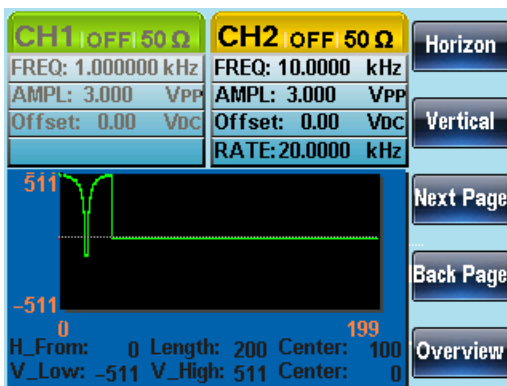

13. To zoom out of the waveform, press F5 (Zoom out). The Zoom out function will increase the length by 2. The Vertical low maximum can be set to -511 and the vertical high maximum can be set to +511. Zoom out F5

Below, the AbsAtan wave is with a vertical low of -511, a vertical high 511 and a center of 0.



Page Navigation (Back Page)

Background When viewing the waveform, the display window can be moved forward and backward using the Next/Back Page functions.

- Panel Operation**
1. Press the ARB key. 
 2. Press F1 (Display).  
 3. Press F4 (Back Page) to move the display window one view length backward.  

$$H_From^* = H_From - Length$$

$$Center^* = Center - Length$$

*Length until 0

Below, shows the display after Back Page has been pressed.

H_From: 200 → 0





Length: 200

Center: 300 → 100



Page Navigation (Next Page)

Background When viewing the waveform, the display window can be moved forward and backward using the Next/Back Page functions.

- Panel Operation**
1. Press the ARB key. 
 2. Press F1 (Display).  
 3. Press F3 (Next Page) to move the display window one view length forward.  

$$H_From^* = H_From + Length$$

$$Center = Center + Length$$

$$*H_From + Length \leq 4096$$

Below, shows the display after Next Page has been pressed.

H_From: 0 → 200

Length: 200

Center: 100 → 300

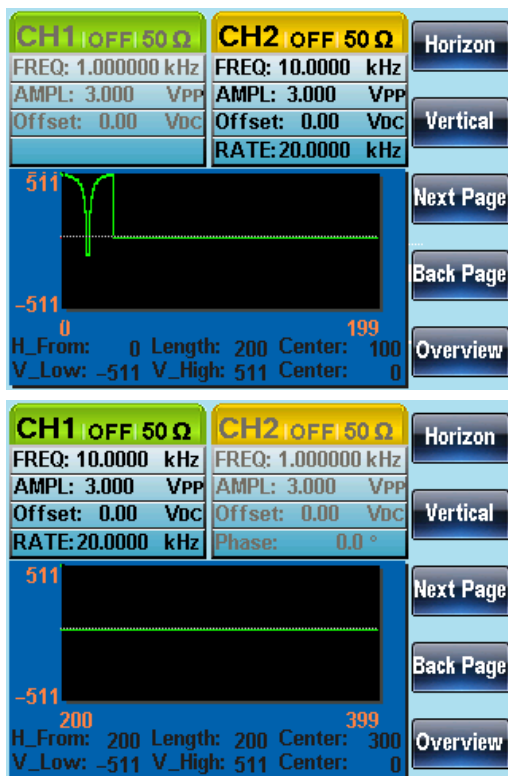

Display

Panel Operation

1. Press the ARB key.



2. Press F1 (Display).



3. To make the display window cover the whole waveform, press F5 (Overview).



Horizontal: 0~4095

Vertical: 511~ -511

Below shows the display after Overview has been selected.

H_From: 0 → 0

Length: 400→4096

Center:200→ 2048

Vertical low/high: ±511

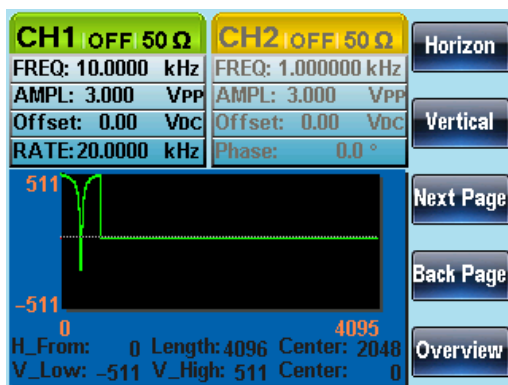

Editing an Arbitrary Waveform

Adding a Point to an Arbitrary Waveform

Background The AFG-2225 has a powerful editing function that allows you to create points or lines anywhere on the waveform.

Panel Operation 1. Press the ARB key.



2. Press F2 (Edit).



3. Press F1 (Point).



4. Press F1 (Address).



5. The Address parameter becomes highlighted.



6. Use the arrow keys and scroll wheel or number pad to enter the Address value.

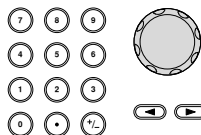

7. Press F2 (Enter) to save the settings.



8. Press Return to return to the previous menu.



9. Press F2 (Data).



10. The Data parameter will become highlighted.

11. Use the selector keys and scroll wheel or number pad to enter a Data value.

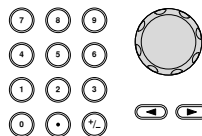

12. Press F2 (Enter) to save the settings.



13. Press Return to return to the previous menu.



14. Press return again to go back to the ARB menu.



In the following figure the edited address is shown in red.

Address 100, Data 200

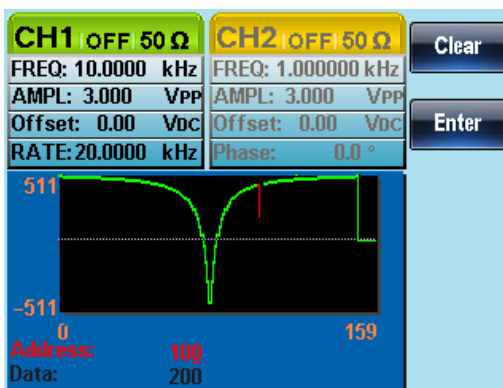

Adding a Line to an Arbitrary Waveform

Background

The AFG-2225 has a powerful editing function that allows you to create points or lines anywhere on the waveform.

Panel Operation 1. Press the ARB key.



2. Press F2 (Edit).



3. Press F2 (Line).



4. Press F1 (Start ADD).



5. The Start Address parameter will be highlighted in red.



6. Use the arrowkeys keys and scroll wheel or number pad to enter the start address.

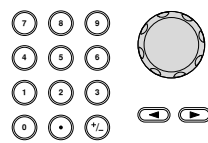

7. Press F2 (Enter) to save the settings.



8. Press Return to return to the previous menu.



9. Repeat steps 4~8 for Start Data (F2), Stop Address (F3) and Stop Data (F4).

10. Press F5 (Done) to confirm the line edit.



11. Press Return to return to the previous menu.



The red line was created below with the following properties:

Start Address: 0, Start Data: 0

Stop Address: 32, Stop Data: 0

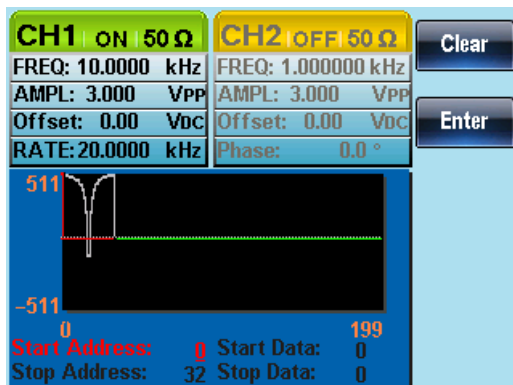

Copy a Waveform

Panel Operation 1. Press the ARB key.



2. Press F2 (Edit).



3. Press F3 (Copy).



4. Press F1 (Start).



5. The Copy From properties will become highlighted in red.



6. The the arrow keys and scroll wheel or number pad to enter the Copy From address.

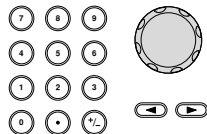

7. Press F2 (Enter) to save the settings.



8. Press Return to return to the previous menu.



9. Repeat steps 4~8 for Length (F2) and Paste To (F3).

10. Press F5 (Done) to confirm the selection.



11. Press Return to return to the previous menu.



A section of the waveform from points 0~33 was copied to points 50~83:

Copy From: 0
 Length: 33
 To: 50

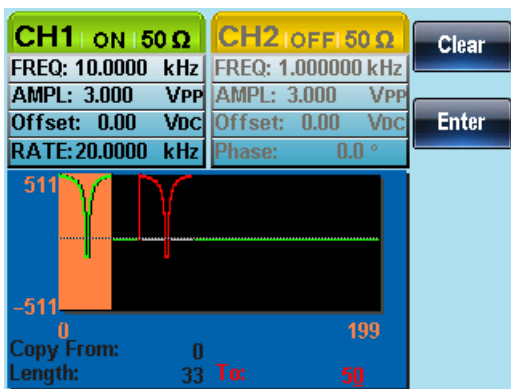

Clear the Waveform

Panel Operation 1. Press the ARB key.



2. Press F2 (Edit).



3. Press F4 (Clear).



4. Press F1 (Start).



5. The Clear From properties will become highlighted in red.



6. Use the arrow keys and scroll wheel or number pad to enter the Clear From address.

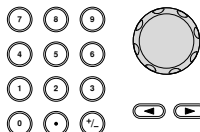

7. Press F2 (Enter) to save the settings.



8. Press Return to return to the previous menu.



9. Repeat steps 4~8 for Length (F2).



10. Press F3 (Done) to clear the selected section of the arbitrary waveform.



Delete All

11. Press F4 (ALL) to delete the whole waveform.



12. Press F1 (Done) again to confirm the deletion.



13. Press Return return to the previous menu.



Clear From: 20, Length: 33.

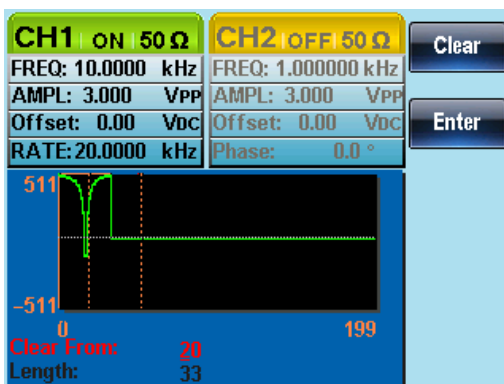

The same area after being cleared:

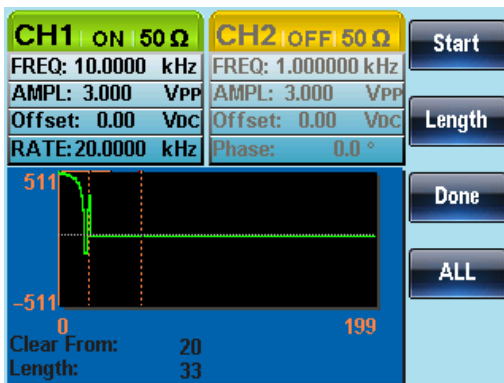

The result after the whole waveform is deleted:



ARB Protection

The protection function designates an area of the arbitrary waveform that cannot be altered.

Panel Operation 1. Press the ARB key.



2. Press F2 (Edit).



3. Press F5 (Protect).





4. Press F2 (Start).



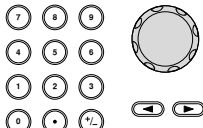

5. The Protect Start properties will become highlighted in red.





6. Use the arrow keys and scroll wheel or number pad to enter the Protect Start address. 

7. Press F2 (Enter) to save the settings. 

8. Press Return to return to the previous menu. 

9. Repeat steps 4~8 for Length (F3). 

10. Press F4 (Done) to confirm the protected area. 

Protect All 11. Press F1 (ALL) to protect the whole waveform. 

12. Press F1 (Done) to confirm. 

Unprotect All 13. Press F5 (Unprotect) to unprotect the whole waveform. 

14. Press F1 (Done) to confirm. 

15. The waveform background will return back to black. The property "Protect Off" be will grayed out.

Below, the protected areas of the waveform are shown with an orange background:

Start:0, Length: 100.

The image displays two screenshots of the AFG-2225 Series User Manual's waveform protection interface. The top screenshot shows the 'Protect Off' state, where the waveform area is black. The bottom screenshot shows the 'Protect On' state, where the waveform area is orange. The interface includes parameter settings for CH1 and CH2, and a vertical column of control buttons on the right.

CH1 OFF 50 Ω	CH2 OFF 50 Ω	Clear
FREQ: 10.0000 kHz	FREQ: 1.000000 kHz	Enter
AMPL: 3.000 VPP	AMPL: 3.000 VPP	
Offset: 0.00 Vdc	Offset: 0.00 Vdc	
RATE: 20.0000 kHz	Phase: 0.0 $^{\circ}$	

511
-511
0
Protect Start: 0
Length: 100
Protect Off 199

CH1 ON 50 Ω	CH2 OFF 50 Ω	ALL
FREQ: 10.0000 kHz	FREQ: 1.000000 kHz	Start
AMPL: 3.000 VPP	AMPL: 3.000 VPP	
Offset: 0.00 Vdc	Offset: 0.00 Vdc	
RATE: 20.0000 kHz	Phase: 0.0 $^{\circ}$	

511
-511
0
Protect Start: 0
Length: 100
Protect On 199

Length
Done
Unprotect

Output an Arbitrary Waveform

The arbitrary waveform generator can output up to 4k points (2~4096).

Output Arbitrary Waveform

Panel Operation 1. Press the ARB key.



2. Press F4 (Output).



3. Press F1 (Start).



4. The Start property will become highlighted in red.



5. Use the arrow keys and scroll wheel or number pad to enter the Start address.

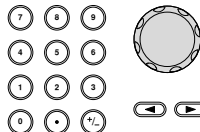

6. Press F2 (Enter) to confirm the start point.



7. Press Return to return to the previous menu.



8. Repeat steps 4~7 for Length (F2).



9. Press Return to return to the previous menu.



The front panel terminal will output the following waveform.



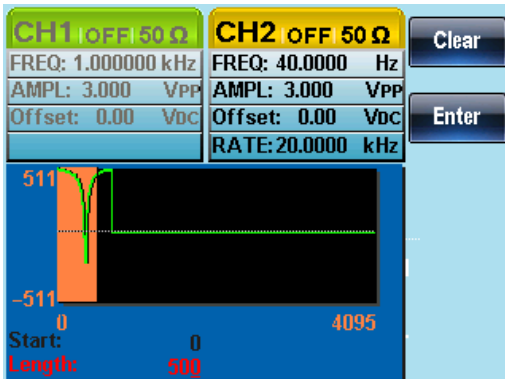





Start 0, Length 500

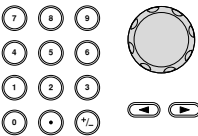

Saving/Loading an Arbitrary Waveform

The AFG-2225 can save and load arbitrary waveforms from 10 internal memory slots. Arbitrary waveforms can also be saved and loaded from a USB memory stick.

Saving a Waveform to Internal Memory

- Panel Operation
1. Press the ARB key. 
 2. Press F5 (More). 
 3. Press F1 (Save). 
 4. Press F1 (Start). 
 5. The Start property will become highlighted in red.
 6. Use the arrow keys and scroll wheel or number pad to enter the Start address. 
 7. Press F2 (Enter) to confirm the start point. 
 8. Press Return to return to the previous menu. 
 9. Repeat steps 4~8 for Length (F2). 
 10. Press F3 (Memory). 

11. Select a memory file using the scroll wheel.

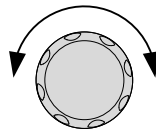

Memory0~Memory9

12. Press F1 (Select) to save the selected memory file.



13. Press Return to return to the previous menu.



Below the file Memory0 is selected using the scroll wheel.

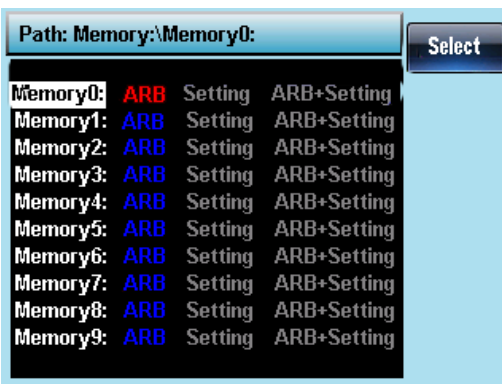

Saving a Waveform to USB Memory

Panel Operation 1. Press the ARB key.



2. Press F5 (More).



3. Press F1 (Save).



4. Press F1 (Start).



5. The Start property will become highlighted in red.

6. Use the arrow keys and scroll wheel or number pad to enter the Start address.

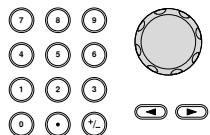

7. Press F2 (Enter) to confirm the start point.



8. Press Return to return to the previous menu.



9. Repeat steps 4~8 for Length (F2).



10. Press F4 (USB).



11. Use the scroll wheel to navigate the file system.

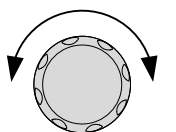

12. Press Select to select directories or files.



Create a Folder 1. Press F2 (New Folder).



2. The text editor will appear with a default folder name of "NEW_FOL".

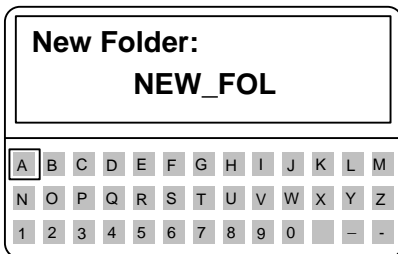

3. Use the scroll wheel to move the cursor.

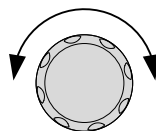

4. Use F1 (Enter Char) or F2 (Backspace) to create a folder name.



5. Press F5 (Save) to save the folder name.



Create a New File 1. Press F3 (New File).



2. The text editor will appear with a default file name of "NEW_FIL".

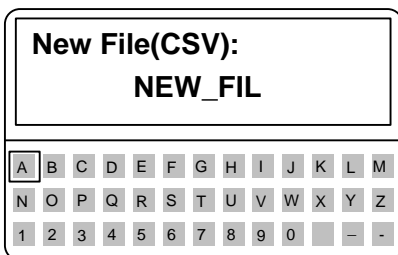

- Use the scroll wheel to move the cursor.

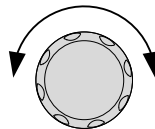

- Use F1 (Enter Char) or F2 (Backspace) to create a file name.



- Press F5 (Save) to save the file name.



Below the folder, BIN, has been created in the root directory.

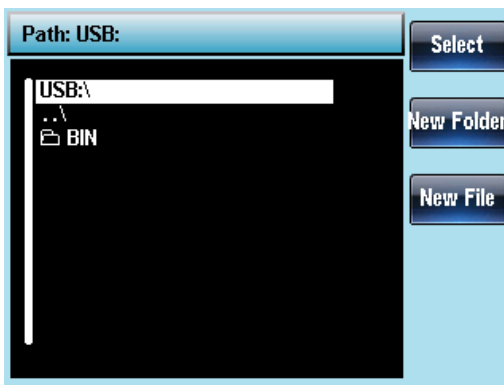

Load a Waveform from Internal Memory

- Panel Operation
- Press the ARBkey.



- Press F5 (More).



- Press F2 (Load).



- Press F1 (Memory).



5. Use the scroll wheel to choose a memory file.

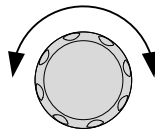

6. Press Select to load the selected memory file.



7. Press F3 (To) to choose the starting point for the loaded waveform.



8. The Load To parameter will become highlighted in red.



9. Use the selector keys and scroll wheel or number pad to enter the starting point.

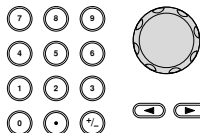

10. Press F2(Enter) to confirm the start point.



11. Press Return to return to the previous menu.















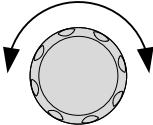

12. Press F4(Done).

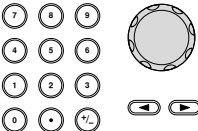

Below the file Memory0 is selected using the scroll wheel loaded to position 0.

Load a Waveform from USB

- Panel Operation
1. Press the ARB key. 
 2. Press F5 (More).  
 3. Press F2 (Load).  
 4. Press F2 (USB).  
 5. Use the scroll wheel to choose a file name. 
 6. Press F1 (Select) to select the file to load.  
 7. Press F3 (To) to choose the starting point for the loaded waveform.  
 8. The Load To property will become highlighted in red.
 9. Use the arrow keys and scroll wheel or number pad to enter the starting point. 
 10. Press F2(Enter) to confirm the Start point.  
 11. Press F4(Done).  

Below the file AFG.CSV is selected using the scroll wheel loaded to position 0.

The screenshot shows a file selection interface. At the top, a path is set to "USB:". Below this, a scrollable list shows the contents of the USB drive: ".\", "FKP", and "AFG.CSV". A "Select" button is located to the right of the list. Below the file selection area, there are two columns of settings for Channel 1 (CH1) and Channel 2 (CH2). Each column has a "Clear" button to its right. At the bottom, a waveform display shows a red pulse on a black background. The pulse starts at 0 and reaches a peak of 511. The x-axis is labeled "Load Vec" and has markers at 0 and 199. The y-axis has markers at 511 and -511.

CH1 OFF 50 Ω	CH2 OFF 50 Ω
FREQ: 10.0000 kHz	FREQ: 1.000000 kHz
AMPL: 3.000 Vpp	AMPL: 3.000 Vpp
Offset: 0.00 Vdc	Offset: 0.00 Vdc
RATE: 20.0000 kHz	Phase: 0.0 $^\circ$

Waveform Display: Load Vec (0 to 199), Y-axis (511, -511)

REMOTE INTERFACE

Establishing a Remote Connection	181
Configure USB interface	181
Remote control terminal connection.....	182
Command Syntax.....	184

Establishing a Remote Connection

The AFG-2225 supports USB remote connections.

Configure USB interface

USB configuration	PC side connector	Type A, host
	AFG-2225 side connector	Type B, slave
	Speed	1.1/2.0 (full speed)

Panel Operation 1. Connect the USB cable to the rear panel USB B (slave) port.



- When the PC asks for the USB driver, select XXXXXXXX.inf included in the software package or download the driver from the GW website, www.gwinstek.com.

Remote control terminal connection

Terminal application	<p>Invoke the terminal application such as MTTY (Multi-Threaded TTY). For USB, set the COM port, baud rate, stop bit, data bit, and parity accordingly.</p> <p>To check the COM port No, see the Device Manager in the PC. For WinXP, Control panel → System → Hardware tab.</p>
Functionality check	<p>Run this query command via the terminal.</p> <pre>*!dn?</pre> <p>This should return the Manufacturer, Model number, Serial number, and Firmware version in the following format.</p> <pre>GW INSTEK, AFG-2225, SN:XXXXXXXX, Vm.mm</pre> <p>Note: ^j or ^m can be used as the terminal character when using a terminal program.</p>
PC Software	<p>The proprietary PC software, downloadable from GWInstek website, can be used for remote control.</p>
Display	<p>When a remote connection is established all panel keys are locked bar F5.</p> <ol style="list-style-type: none"> Press REM/LOCK (F5) to return the function generator to local mode. <div style="display: flex; align-items: center; margin-left: 20px;"> <div style="border: 1px solid black; padding: 2px 5px; margin-right: 10px;">REM/LOCK</div> <div style="border: 1px solid black; border-radius: 15px; padding: 2px 10px; margin-right: 10px;">F5</div> </div>

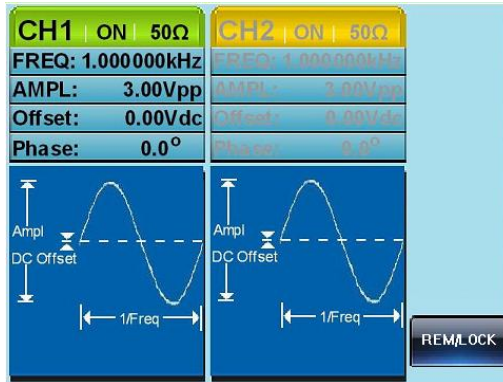

Command Syntax

Compatible standard	<ul style="list-style-type: none"> • IEEE488.2, 1992 (fully compatible) • SCPI, 1994 (partially compatible)
---------------------	---

Command Tree The SCPI standard is an ASCII based standard that defines the command syntax and structure for programmable instruments.

Commands are based on a hierarchical tree structure. Each command keyword is a node on the command tree with the first keyword as the root node. Each sub node is separated with a colon.

Shown below is a section of the `SOURce[1|2]` root node and the `:PM` and `:PULSe` sub nodes.

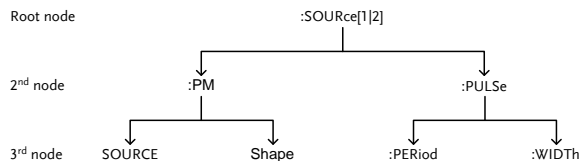

Command types Commands can be separated in to three distinct types, simple commands, compound commands and queries.

Simple	A single command with/without a parameter
Example	*OPC
Compound	Two or more commands separated by a colon (:) with/without a parameter
Example	SOURce1:PULSe:WIDTh

Query	A query is a simple or compound command followed by a question mark (?). A parameter (data) is returned. The maximum or minimum value for a parameter can also be queried where applicable.
Example	SOURce1:FREQuency? SOURce1:FREQuency? MIN

Command forms Commands and queries have two different forms, long and short. The command syntax is written with the short form of the command in capitals and the remainder (long form) in lower case.

The diagram shows the command `SOURce1:DCOffset`. Brackets are drawn under `SOURce1` and `DCOffset`. Below the `SOURce1` bracket is the word "short". Above the `SOURce1` bracket is the word "long". Below the `DCOffset` bracket is the word "short". Above the `DCOffset` bracket is the word "long".

The commands can be written in capitals or lower-case, just so long as the short or long forms are complete. An incomplete command will not be recognized.

Below are examples of correctly written commands:

```
LONG  SOURce1:DCOffset
      SOURCE1:DCOFFSET
      source1:dcoffset
```

```
SHORT SOUR1:DCO
      sour1:dco
```

Command Format	$\text{SOURce1:DCOffset} \underbrace{\langle \text{offset} \rangle}_{\substack{2 \\ 3 \\ 4}} \text{LF}$	1: command header 2: single space 3: parameter 4: message terminator
-------------------	---	---

Square Brackets [] Commands that contain squares brackets indicate that the contents are optional. The function of the command is the same with or without the square bracketed items. Brackets are not sent with the command.

For example, the frequency query below can use any of the following 3 forms:

SOURce1:FREQuency? [MINimum|MAXimum]

SOURce1:FREQuency? MAXimum

SOURce1:FREQuency? MINimum

SOURce1:FREQuency?

Braces {} Commands that contain braces indicate one item within the braces must be chosen. Braces are not sent with the command.

Angled Brackets <> Angle brackets are used to indicate that a value must be specified for the parameter. See the parameter description below for details. Angled brackets are not sent with the command.

Bars | Bars are used to separate multiple parameter choices in the command format.

Parameters	Type	Description	Example
	<Boolean>	Boolean logic	0, 1/ON,OFF
	<NR1>	integers	0, 1, 2, 3
	<NR2>	decimal numbers	0.1, 3.14, 8.5
	<NR3>	floating point	4.5e-1, 8.25e+1
	<NRf>	any of NR1, 2, 3	1, 1.5, 4.5e-1

<NRf+> <Numeric>	NRf type with a suffix including MINimum, MAXimum or DEFault parameters.	1, 1.5, 4.5e-1 MAX, MIN,
<aard>	Arbitrary ASCII characters.	
<discrete>	Discrete ASCII character parameters	IMM, EXT, MAN
<frequency> <peak deviation in Hz> <rate in Hz>	NRf+ type including frequency unit suffixes.	1 KHZ, 1.0 HZ, MHZ
<amplitude>	NRf+ type including voltage peak to peak.	VPP
<offset>	NRf+ type including volt unit suffixes.	V
<seconds>	NRf+ type including time unit suffixes.	NS, S MS US
<percent> <depth in percent>	NRf type	N/A
Message terminators	LF CR	line feed code (new line) and carriage return.
	LF	line feed code (new line)
	EOI	IEEE-488 EOI (End-Or-Identify)
 Note	λj or λm should be used when using a terminal program.	

Command Separators	Space	A space is used to separate a parameter from a keyword/command header.
	Colon (:)	A colon is used to separate keywords on each node.
	Semicolon (;)	A semi colon is used to separate subcommands that have the same node level. For example: SOURce[1 2]:DCOffset? SOURce[1 2]:OUTPut? →SOURce1:DCOffset?;OUTPut?
	Colon + Semicolon (;:)	A colon and semicolon can be used to combine commands from different node levels. For example: SOURce1:PM:SOURce? SOURce:PULSe:WIDTh? →SOURce1:PM:SOURce?;;SOURce:PULSe:WIDTh?
	Comma (,)	When a command uses multiple parameters, a comma is used to separate the parameters. For example: SOURce:APPLy:SQUare 10KHZ, 2.0 VPP, -1V

Command List

System Commands	193
SYSTem:ERRor?	193
*IDN?	193
*RST	194
SYSTem:VERSion?	194
*OPC	194
*OPC?	195
*WAI	195
Status Register Commands	196
*CLS	196
*ESE	196
*ESR?	197
*STB?	197
*SRE	198
System Remote Commands	199
SYSTem:LOCal	199
SYSTem:REMote	199
Apply Commands	200
SOURce[1 2]:APPLY:SINusoid	202
SOURce[1 2]:APPLY:SQUare	202
SOURce[1 2]:APPLY:RAMP	203
SOURce[1 2]:APPLY:PULSe	203
SOURce[1 2]:APPLY:NOISe	204
SOURce[1 2]:APPLY:USER	204
SOURce[1 2]:APPLY?	205
Output Commands	206
SOURce[1 2]:FUNction	206
SOURce[1 2]:FREQuency	207
SOURce[1 2]:AMPlitude	209
SOURce[1 2]:DCOffset	210
SOURce[1 2]:SQUare:DCYCLE	211
SOURce[1 2]:RAMP:SYMMetry	212
OUTPut[1 2]	213
OUTPut[1 2]:LOAD	213
SOURce[1 2]:VOLTage:UNIT	214
Pulse Configuration Commands	216
SOURce[1 2]:PULSe:PERiod	216
SOURce[1 2]:PULSe:WIDTh	217
Amplitude Modulation (AM) Commands	218
AM Overview	218
SOURce[1 2]:AM:STATe	219

SOURce[1 2]:AM:SOURce	219
SOURce[1 2]:AM:INternal:FUNction	220
SOURce[1 2]:AM:INternal:FREQuency	221
SOURce[1 2]:AM:DEPth	221
Frequency Modulation (FM) Commands	223
FM Overview	223
SOURce[1 2]:FM:STATe	224
SOURce[1 2]:FM:SOURce	224
SOURce[1 2]:FM:INternal:FUNction	225
SOURce[1 2]:FM:INternal:FREQuency	226
SOURce[1 2]:FM:DEVIation	226
Frequency-Shift Keying (FSK) Commands	228
FSK Overview	228
SOURce[1 2]:FSKey:STATe	228
SOURce[1 2]:FSKey:SOURce	229
SOURce[1 2]:FSKey:FREQuency	229
SOURce[1 2]:FSKey:INternal:RATE	230
Phase Modulation (PM) Commands	232
PM Overview	232
SOURce[1 2]:PM:STATe	233
SOURce[1 2]:PM:SOURce	233
SOURce[1 2]:PM:INternal:FUNction	234
SOURce[1 2]:PM:INternal:FREQuency	234
SOURce[1 2]:PM:DEVIation	235
SUM Modulation (SUM) Commands	236
SUM Overview	236
SOURce[1 2]:SUM:STATe	237
SOURce[1 2]:SUM:SOURce	237
SOURce[1 2]:SUM:INternal:FUNction	238
SOURce[1 2]:SUM:INternal:FREQuency	238
SOURce[1 2]:SUM:AMPL	239
Frequency Sweep Commands	240
Sweep Overview	240
SOURce[1 2]:SWEep:STATe	241
SOURce[1 2]:FREQuency:STARt	242
SOURce[1 2]:FREQuency:STOP	242
SOURce[1 2]:FREQuency:CENTer	243
SOURce[1 2]:FREQuency:SPAN	244
SOURce[1 2]:SWEep:SPACing	245
SOURce[1 2]:SWEep:TIME	245
SOURce[1 2]:SWEep:SOURce	246
SOURce[1 2]:MARKer:FREQuency	247
SOURce[1 2]:MARKer	247
Burst Mode Commands	249

Burst Mode Overview.....	249
SOURce[1 2]:BURSt:STATe	251
SOURce[1 2]:BURSt:MODE	251
SOURce[1 2]:BURSt:NCYCles	252
SOURce[1 2]:BURSt:INTernal:PERiod	253
SOURce[1 2]:BURSt:PHASe	254
SOURce[1 2]:BURSt:TRIGger:SOURce	254
SOURce[1 2]:BURSt:TRIGger:DELay	255
SOURce[1 2]:BURSt:TRIGger:SLOPe	256
SOURce[1 2]:BURSt:GATE:POLarity	257
SOURce[1 2]:BURSt:OUTPut:TRIGger:SLOPe	257
OUTPut[1 2]:TRIGger	258
Arbitrary Waveform Commands	260
Arbitrary Waveform Overview	260
SOURce[1 2]:FUNCTion USER	261
DATA:DAC	261
SOURce[1 2]:ARB:EDIT:COPIY	262
SOURce[1 2]:ARB:EDIT:DELeTe	263
SOURce[1 2]:ARB:EDIT:DELeTe:ALL	263
SOURce[1 2]:ARB:EDIT:POINt.....	263
SOURce[1 2]:ARB:EDIT:LINE	264
SOURce[1 2]:ARB:EDIT:PROTeCt.....	264
SOURce[1 2]:ARB:EDIT:PROTeCt:ALL	265
SOURce[1 2]:ARB:EDIT:UNProteCt.....	265
SOURce[1 2]:ARB:OUTPut	265
COUNTER	266
COUNTER:STATE.....	266
COUNter:GATe	266
COUNter:VALue?	267
PHASE.....	267
SOURce[1 2]:PHASe.....	267
SOURce[1 2]:PHASe:SYNChronize.....	268
SOURce[1 2]:PHASe:SYNChronize.....	268
SOURce1:PHASe:SYNChronize.....	268
COUPLE	268
SOURce[1 2]:FREQuency:COUPle:MODE.....	268
SOURce[1 2]:FREQuency:COUPle:OFFSet	269
SOURce[1 2]:FREQuency:COUPle:RATio	269
SOURce[1 2]:AMPlitude:COUPle:STATe	269
SOURce[1 2]:TRACk	270
Save and Recall Commands	271
*SAV	271
*RCL	271
MEMory:STATe:DELeTe.....	271

MEMory:STATe:DELeTe ALL 272

System Commands

SYSTEM:ERRor?

System Query

Description Reads an error from the error queue. See page 292 for details regarding the error queue.

Query Syntax **SYSTEM:ERRor?**

Return parameter <string> Returns an error string, <256 ASCII characters.

Example **SYSTEM:ERRor?**
-138 Suffix not allowed
 Returns an error string.

*IDN?

System Query

Description Returns the function generator manufacturer, model number, serial number and firmware version number in the following format:
 GW INSTEK,AFG-2225,SN:XXXXXXXX,Vm.mm

Query Syntax ***IDN?**

Return parameter <string>

Example ***IDN?**
 GW INSTEK,AFG-2225,SN:XXXXXXXX,Vm.mm
 Returns the identification of the function generator.

***RST** System Command

Description Reset the function generator to its factory default state.

Note Note the *RST command will not delete instrument save states in memory.

Syntax ***RST**

SYSTEM:VERSion? System Query

Description Performs a system version query. Returns a string with the instrument, firmware version, FPGA revision

Query Syntax **SYSTEM:VERSion?**

Return parameter <string>

Example **SYST:VERS?**
 AFG-2225 VX.XXX_XXXX
 Returns the year and version for that year (1).

***OPC** System Command

Description This command sets the Operation Complete Bit (bit 0) of the Standard Event Status Register after the function generator has completed all pending operations. For the AFG-2225, the *OPC command is used to indicate when a sweep or burst has completed.

Note Before the OPC bit is set, other commands may be executed.

Syntax ***OPC**

*OPC?		System Query
Description	Returns the OPC bit to the output buffer when all pending operations have completed. I.e. when the OPC bit is set.	
Note	Commands cannot be executed until the *OPC? query has completed.	
Query Syntax	*OPC?	
Return parameter	1	
Example	*OPC? 1 Returns a "1" when all pending operations are complete.	
*WAI		System Command
Description	This command waits until all pending operations have completed before executing additional commands. I.e., when the OPC bit is set.	
Note	This command is only used for triggered sweep and burst modes.	
Syntax	*WAI	

Status Register Commands

***CLS** System Command

Description The *CLS command clears all the event registers, the error queue and cancels an *OPC command.

Syntax ***CLS**

***ESE** System Command

Description The Standard Event Status Enable command determines which events in the Standard Event Status Event register can set the Event Summary Bit (ESB) of the Status Byte register. Any bit positions set to 1 enable the corresponding event. Any enabled events set bit 5 (ESB) of the Status Byte register.

Note The *CLS command clears the event register, but not the enable register.

Syntax ***ESE <enable value>**

Parameter <enable value> 0~255

Example ***ESE 20**
 Sets a bit weight of 20 (bits 2 and 4).

Query Syntax ***ESE?**

Return Parameter	Bit	Register	Bit	Register
	0	Not used	4	Message Available
	1	Not used	5	Standard Event
	2	Error Queue	6	Master Summary
	3	Questionable Data	7	Not used

Example ***ESE?**
 4
 Bit 2 is set.

***ESR?** System Command

Description Reads and clears the Standard Event Status Register. The bit weight of the standard event status register is returned.

Note The *CLS will also clear the standard event status register.

Query Syntax ***ESR?**

Return Parameter	Bit	Register	Bit	Register
	0	Operation Complete	4	Execution Error
	1	Not Used	5	Command Error
	2	Query Error	6	Not Used
	3	Device Error	7	Power On

Query Example ***ESR?**
 5
 Returns the bit weight of the standard event status register (bit 0 and 2).

***STB?** System Command

Description Reads the Status byte condition register.

Note Bit 6, the master summary bit, is not cleared.

Syntax ***STB?**

***SRE** System Command

Description The Service Request Enable Command determines which events in the Status Byte Register are allowed to set the MSS (Master summary bit). Any bit that is set to "1" can cause the MSS bit to be set.

Note The *CLS command clears the status byte event register, but not the enable register.

Syntax ***SRE <enable value>**

Parameter <enable value> 0~255

Example ***SRE 12**

Sets a bit weight of 12 (bits 2 and 3) for the service request enable register.

Query Syntax ***SRE?**

Return Parameter	Bit	Register	Bit	Register
	0	Not used	4	Message Available
	1	Not used	5	Standard Event
	2	Error Queue	6	Master Summary
	3	Questionable Data	7	Not used

Query Example ***SRE?**
12

Returns the bit weight of the status byte enable register.

System Remote Commands

SYSTem:LOCal System Command

Description	Sets the function generator to local mode. In local mode, all front panel keys are operational.
-------------	---

Syntax	SYSTem:LOCal
--------	---------------------

Example	SYST:LOC
---------	-----------------

SYSTem:REMOte System Command

Description	Disables the front panel keys and puts the function generator into remote mode
-------------	--

Syntax	SYSTem:REMOte
--------	----------------------

Example	SYST:REM
---------	-----------------

Apply Commands

The APPLy command has 5 different types of outputs (Sine, Square, Ramp, Pulse, Noise,). The command is the quickest, easiest way to output waveforms remotely. Frequency, amplitude and offset can be specified for each function.

As only basic parameters can be set with the Apply command, other parameters use the instrument default values.

The Apply command will set the trigger source to immediate and disable burst, modulation and sweep modes. Turns on the output command OUTPut[1 | 2] ON. The termination setting will not be changed.

As the frequency, amplitude and offset parameters are in nested square brackets, amplitude can only be specified if the frequency has been specified and offset can only be specified if amplitude has been set. For the example:

```
SOURce[1 | 2]:APPLy:SINusoid [<frequency> [<amplitude>
[,<offset>] ]]
```

Output Frequency For the output frequency, MINimum, MAXimum and DEFault can be used. The default frequency for all functions is set to 1 kHz. The maximum and minimum frequency depends on the function used. If a frequency output that is out of range is specified, the max/min frequency will be used instead. A "Data out range error will be generated" from the remote terminal.

**Output
Amplitude**

When setting the amplitude, MINimum, MAXimum and DEFault can be used. The range depends on the function being used and the output termination (50Ω or high impedance). The default amplitude for all functions is 100 mVpp (50Ω).

If the amplitude has been set and the output termination is changed from 50Ω to high impedance, the amplitude will double. Changing the output termination from high impedance to 50Ω will half the amplitude.

Vrms, dBm or Vpp units can be used to specify the output unit to use with the current command. The VOLT:UNIT command can be used to set the units when no unit is specified with the Apply command. If the output termination is set to high impedance, dBm units cannot be used. The units will default to Vpp.

The output amplitude can be affected by the function and unit chosen. Vpp and Vrms or dBm values may have different maximum values due to differences such as crest factor. For example, a 5Vrms square wave must be adjusted to 3.536 Vrms for a sine wave.

DC Offset voltage The offset parameter can be set to MINimum, MAXimum or DEFault. The default offset is 0 volts. The offset is limited by the output amplitude as shown below.

$$|V_{offset}| < V_{max} - V_{pp}/2$$

If the output specified is out of range, the maximum offset will be set.

The offset is also determined by the output termination (50Ω or high impedance). If the offset has been set and the output termination has changed from 50Ω to high impedance, the offset will double. Changing the output termination from high impedance to 50Ω will half the offset.

SOURce[1 2]:APPLy:SINusoid		Source Specific Command
Description	Outputs a sine wave from the selected channel when the command has executed. Frequency, amplitude and offset can also be set.	
Syntax	SOURce[1 2]:APPLy:SINusoid [<frequency> [,<amplitude> [,<offset>]]]	
Parameter	<frequency>	1μHz~25MHz
	<amplitude>	1mVpp~10Vpp (50Ω) (3.536 Vrms)
	<offset>	-4.99V~4.99V (50Ω)
Example	SOUR1:APPL:SIN 2KHZ,MAX,MAX Sets frequency to 2kHz and sets the amplitude and offset to the maximum.	

SOURce[1 2]:APPLy:SQUare		Source Specific Command
Description	Outputs a square wave from the selected channel when the command has executed. Frequency, amplitude and offset can also be set. The duty cycle is set to 50%.	
Syntax	SOURce[1 2]:APPLy:SQUare [<frequency> [,<amplitude> [,<offset>]]]	
Parameter	<frequency>	1μHz~25MHz
	<amplitude>	1mVpp~10Vpp (50Ω)
	<offset>	-4.99V~4.99V (50Ω)
Example	SOUR1:APPL:SQU 2KHZ,MAX,MAX	

Sets frequency to 2kHz and sets the amplitude and offset to the maximum.

SOURce[1|2]:APPLy:RAMP Source Specific Command

Description Outputs a ramp wave from the selected channel when the command has executed. Frequency, amplitude and offset can also be set. The symmetry is set to 50%.

Syntax **SOURce[1|2]:APPLy:RAMP [<frequency> [,<amplitude> [,<offset>]]]**

Parameter	<frequency>	1μHz~1MHz
	<amplitude>	1mVpp~10Vpp (50Ω)
	<offset>	-4.99V~4.99V (50Ω)

Example **SOUR1:APPL:RAMP 2KHZ,MAX,MAX**
 Sets frequency to 2kHz and sets the amplitude and offset to the maximum.

SOURce[1|2]:APPLy:PULSe Source Specific Command

Description Outputs a pulse waveform from the selected channel when the command has executed. Frequency, amplitude and offset can also be set.

Note The PW settings from the SOURce[1|2]:PULS:WIDT command are preserved. Edge and pulse width may be adjusted to supported levels. Repetition rates will be approximated from the frequency. For accurate repetition rates, the period should be adjusted using the SOURce[1|2]:PULS:PER command

Syntax **SOUR[1|2]:APPLy:PULSe [<frequency> [,<amplitude> [,<offset>]]]**

Parameter	<frequency>	500μHz~25MHz
	<amplitude>	1mVpp~10Vpp (50Ω)

	<code><offset></code>	<code>-4.99V~4.99V (50Ω)</code>
--	-----------------------------	---------------------------------

Example **SOUR1:APPL:PULS 1KHZ,MIN,MAX**

Sets frequency to 1kHz and sets the amplitude to minimum and the and offset to the maximum.

SOURce[1|2]:APPLy:NOISe Source Specific Command

Description Outputs Gaussian noise. Amplitude and offset can also be set.

Note Frequency cannot be used with the noise function; however a value (or DEFault) must be specified. The frequency is remembered for the next function used.

Syntax **SOURce[1|2]:APPLy:NOISe [<frequency|DEFault> [,<amplitude> [,<offset>]]]**

Parameter	<code><frequency></code>	Not applicable
	<code><amplitude></code>	1mVpp~10Vpp (50Ω)
	<code><offset></code>	-4.99V~4.99V (50Ω)

Example **SOUR1:APPL:NOIS DEF, 3.0, 1.0**

Sets the amplitude to 3 volts with an offset of 1 volt.

SOURce[1|2]:APPLy:USER Source Specific Command

Description Outputs an arbitrary waveform from the selected channel. The output is that specified from the FUNC:USER command.

Note Frequency and amplitude cannot be used with the DC function; however a value (or DEFault) must be specified. The values are remembered for the next function used.

Syntax	SOURce[1 2]:APPLY:USER [<frequency> [<amplitude> [<offset>]]]	
--------	---	--

Parameter	<frequency>	1 μ Hz~60MHz
	<amplitude>	1mVpp~10Vpp (50 Ω)
	<offset>	-4.99V~4.99V (50 Ω)

Example	SOUR1:APPL:USER
---------	------------------------

SOURce[1 2]:APPLY?	Source Specific Command
---------------------------	-------------------------

Description	Outputs a string with the current settings.
-------------	---

Note	The string can be passed back appended to the Apply Command.
------	--

Syntax	SOURce[1 2]:APPLY?
--------	---------------------------

Return Parameter	<string>	Function, frequency, amplitude, offset
------------------	----------	--

Example	SOUR1:APPL? SIN +5.000000000000E+03,+3.0000E+00,-2.50E+00 Returns a string with the current function and parameters, Sine, 5kHz, 3 Vpp, -2.5V offset.
---------	--

Output Commands

Unlike the Apply commands, the Output commands are low level commands to program the function generator.

This section describes the low-level commands used to program the function generator. Although the APPLy command provides the most straightforward method to program the function generator, the low-level commands give you more flexibility to change individual parameters.

	Source Specific Command
SOURce[1 2]:FUNction	
Description	The FUNction command selects and outputs the selected output. The User parameter outputs an arbitrary waveform previously set by the SOURce[1 2]:FUNC:USER command.
Note	<p>If the function mode is changed and the current frequency setting is not supported by the new mode, the frequency setting will be altered to next highest value.</p> <p>Vpp and Vrms or dBm amplitude values may have different maximum values due to differences such as crest factor. For example, if a 5Vrms square wave is changed to a sinewave, then the Vrms is automatically adjusted to 3.536.</p> <p>The modulation, burst and sweep modes can only be used with some of the basic waveforms. If a mode is not supported, the conflicting mode will be disabled. See the table below.</p>

	Sine	Square	Ramp	Pulse	Noise	ARB
AM	✓	✓	✓	✓	×	✓
FM	✓	✓	✓	×	×	×
PM	✓	✓	✓	×	×	×
FSK	✓	✓	✓	✓	×	×
SUM	✓	✓	✓	✓	✓	×
SWEEP	✓	✓	✓	×	×	×
BURST	✓	✓	✓	×	×	×

Syntax **SOURce[1|2]:FUNCtion {SINusoid|SQUare|RAMP|PULSe|NOISe| USER}**

Example **SOUR1:FUNC SIN**
Sets the output as a sine function.

Query Syntax **SOURce[1|2]:FUNCtion?**

Return Parameter SIN, SQU, RAMP, PULS, NOIS, USER Returns the current output type.

Example **SOUR1:FUNC?**
SIN
Current output is sine.

SOURce[1|2]:FREQuency Source Specific Command

Description The SOURce[1 | 2]:FREQuency command sets the output frequency for the selected channel. The query command returns the current frequency setting.

Note The maximum and minimum frequency depends on the function mode.

Sine, Square	1μHz~25MHz
Ramp	1μHz~1MHz
Pulse	500μHz~25MHz

Noise	Not applicable
User	1μHz~60MHz

If the function mode is changed and the current frequency setting is not supported by the new mode, the frequency setting will be altered to next highest value.

The duty cycle of square waveforms depends on the frequency settings.

1.0% to 99.0% (*frequency* ≤ 100 KHz)

10% to 90% ($100 \text{ KHz} \leq \textit{frequency} \leq 1\text{MHz}$)

50% (*frequency* ≤ 25 MHz)

If the frequency is changed and the set duty cycle cannot support the new frequency, the highest duty cycle available at that frequency will be used. A “settings conflict” error will result from the above scenario.

Syntax	SOURce[1 2]:FREQuency {<frequency> MINimum MAXimum}
--------	--

Example	SOUR1:FREQ MAX Sets the frequency to the maximum for the current mode.
---------	--

Query Syntax	SOURce[1 2]:FREQuency?
--------------	-------------------------------

Return Parameter	<NR3> Returns the frequency for the current mode.
------------------	--

Example	SOUR1:FREQ? MAX +1.0000000000000E+06 The maximum frequency that can be set for the current function is 1MHz.
---------	---

SOURce[1 2]:AMPLitude	Source Specific Command
-----------------------	----------------------------

Description	The SOURce[1 2]:AMPLitude command sets the output amplitude for the selected channel. The query command returns the current amplitude settings.
-------------	---

Note	<p>The maximum and minimum amplitude depends on the output termination. The default amplitude for all functions is 100 mVpp (50Ω). If the amplitude has been set and the output termination is changed from 50Ω to high impedance, the amplitude will double. Changing the output termination from high impedance to 50Ω will half the amplitude.</p>
------	---

The offset and amplitude are related by the following equation.

$$|V_{offset}| < V_{max} - V_{pp}/2$$

If the output termination is set to high impedance, dBm units cannot be used. The units will default to Vpp.

The output amplitude can be affected by the function and unit chosen. Vpp and Vrms or dBm values may have different maximum values due to differences such as crest factor. For example, a 5Vrms square wave must be adjusted to 3.536 Vrms for a sine wave.

The amplitude units can be explicitly used each time the SOURce[1 | 2]:AMPLitude command is used. Alternatively, the VOLT:UNIT command can be used to set the amplitude units for all commands.

Syntax **SOURce[1|2]:AMPlitude {< amplitude> |MINimum|MAXimum}**

Example **SOUR1:AMP MAX**
 Sets the amplitude to the maximum for the current mode.

Query Syntax **SOURce[1|2]:AMPlitude? {MINimum|MAXimum}**

Return Parameter <NR3> Returns the amplitude for the current mode.

Example **SOUR1:AMP? MAX**
 +5.0000E+00
 The maximum amplitude that can be set for the current function is 5 volts.

Source Specific Command

SOURce[1|2]:DCOffset

Description Sets or queries the DC offset for the current mode.

Note
 The offset parameter can be set to MINimum, MAXimum or DEFault. The default offset is 0 volts. The offset is limited by the output amplitude as shown below.

$$|V_{offset}| < V_{max} - V_{pp}/2$$

If the output specified is out of range, the maximum offset will be set.

The offset is also determined by the output termination (50Ω or high impedance). If the offset has been set and the output termination has changed from 50Ω to high impedance, the offset will double. Changing the output termination from high impedance to 50Ω will half the offset.

Syntax	SOURce[1 2]:DCOffset {< offset> MINimum MAXimum}	
Example	SOUR1:DCO MAX Sets the offset to the maximum for the current mode.	
Query Syntax	SOURce[1 2]:DCOffset? {MINimum MAXimum}	
Return Parameter	<NR3>	Returns the offset for the current mode.
Example	SOUR1:DCO? +3.0000E+00 The offset for the current mode is set to +3 volts.	

SOURce[1|2]:SQUare:DCYCLE Source Specific Command

Description	Sets or queries the duty cycle for square waves only. The setting is remembered if the function mode is changed. The default duty cycle is 50%.	
Note	<p>The duty cycle of square waveforms depend on the frequency settings.</p> <p>1.0% to 99.0% (<i>frequency</i> ≤ 100 KHz)</p> <p>10% to 90% (100 KHz ≤ <i>frequency</i> ≤ 1MHz)</p> <p>50% (<i>frequency</i> ≤ 25 MHz)</p> <p>If the frequency is changed and the set duty cycle cannot support the new frequency, the highest duty cycle available at that frequency will be used. A “settings conflict” error will result from the above scenario.</p> <p>For square waveforms, the Apply command and AM/FM modulation modes ignore the duty cycle settings.</p>	
Syntax	SOURce[1 2]:SQUare:DCYCLE {< percent> MINimum MAXimum}	

Example	SOUR1:SQU:DCYC MAX Sets the duty cycle to the highest possible for the current frequency.
Query Syntax	SOURce[1 2]:SQUare:DCYCLE? {MINimum MAXimum}
Return Parameter	<NR3> Returns the duty cycle as a percentage.
Example	SOUR1:SQU:DCYC? +5.00E+01 The duty cycle is set 50%.

SOURce[1|2]:RAMP:SYMMetry Source Specific Command

Description	Sets or queries the symmetry for ramp waves only. The setting is remembered if the function mode is changed. The default symmetry is 50%.
Note	For ramp waveforms, the Apply command and AM/FM modulation modes ignore the current symmetry settings.
Syntax	SOURce[1 2]:RAMP:SYMMetry {< percent> MINimum MAXimum}
Example	SOUR1:RAMP:SYMM MAX Sets the symmetry to the 100%.
Query Syntax	SOURce[1 2]:RAMP:SYMMetry? {MINimum MAXimum}
Return Parameter	<NR3> Returns the symmetry as a percentage.
Example	SOUR1:RAMP:SYMMetry? +1.0000E+02 The symmetry is set as 100%.

OUTPut[1 2]		Source Specific Command
Description	Enables/Disables or queries the front panel output from the selected channel. The default is set to off.	
Note	<p>If the output is overloaded by an external voltage, the output will turn off and an error message will be displayed. The overload must first be removed before the output can be turned on again with output command.</p> <p>Using the Apply command automatically sets the front panel output to on.</p>	
Syntax	OUTPut[1 2] {OFF ON}	
Example	OUTP1 ON Turns the channel 1 output on.	
Query Syntax	OUTPut[1 2]?	
Return Parameter	1	ON
	0	OFF
Example	OUTP1? 1 The channel 1 output is currently on.	

OUTPut[1 2]:LOAD		Source Specific Command
Description	Sets or queries the output termination. Two impedance settings can be chosen, DEFault (50Ω) and INFinity (high impedance >10 kΩ). The output termination is to be used as a reference only. If the output termination is set 50Ω but the actual load impedance is not 50Ω, then the amplitude and offset will not be correct.	
Note	If the amplitude has been set and the output termination is changed from 50Ω to high impedance, the amplitude will double. Changing	

the output termination from high impedance to 50Ω will half the amplitude.

If the output termination is set to high impedance, dBm units cannot be used. The units will default to Vpp.

Syntax	OUTPut[1 2]:LOAD {DEFault INFinity}	
Example	OUTP1:LOAD DEF Sets the channel 1 output termination to 50Ω.	
Query Syntax	OUTPut[1 2]:LOAD?	
Return Parameter	DEF	Default
	INF	INFinity
Example	OUTP1:LOAD? DEF The output termination for channel 1 is set to 50Ω.	

SOURce[1|2]:VOLTage:UNIT Source Specific Command

Description	Sets or queries the output amplitude units. There are three types of units: VPP, VRMS and DBM.	
Note	<p>The units set with the VOLTage:UNIT command will be used as the default unit for all amplitude units unless a different unit is specifically used for a command.</p> <p>If the output termination is set to high impedance, dBm units cannot be used. The Units will automatically default to Vpp.</p>	
Syntax	SOURce[1 2]:VOLTage:UNIT {VPP VRMS DBM}	
Example	SOUR1:VOLT:UNIT VPP Sets the amplitude units to Vpp.	
Query Syntax	SOURce[1 2]:VOLTage:UNIT?	
Return Parameter	VPP	Vpp
	VRMS	Vrms

DBM

dBm

Example

SOUR1:VOLT:UNIT?

VPP

The amplitude units are set to Vpp.

Pulse Configuration Commands

The pulse chapter is used to control and output pulse waveforms. Unlike the APPLY command, low level control is possible including setting the rise time, fall time, period and pulse width.

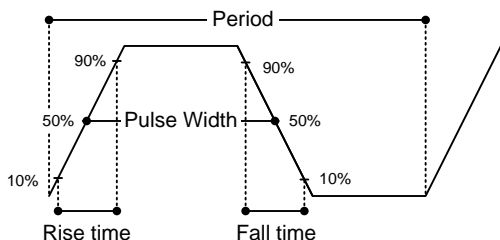

	Source Specific Command
SOURCE[1 2]:PULSE:PERIOD	Source Specific Command
Description	Sets or queries the pulse period. The default period is 1 ms.
Note	<p>The pulse period must be greater than the pulse width and edge time(1.6x) combined.</p> <p>$Pulse\ Width + (1.6 * Edge\ Time) < Period$</p> <p>If the edge time or pulse width are too great, they will automatically be reduced to fit the period by the function generator.</p> <p>The PULSE:PERIOD function will change the period for all functions, not just for the pulse waveforms. If a different function is chosen and the current period is out of range, the period will be automatically adjusted to suit the new function.</p>
Syntax	SOURCE[1 2]:PULSE:PERIOD {<seconds> MINimum MAXimum}
Example	SOUR1:PULS:PER MIN Sets the period to the minimum time allowed.
Query Syntax	SOURCE[1 2]:PULSE:PERIOD? [MINimum MAXimum]
Return Parameter	<seconds> 40ns~2000s

Example	SOUR1:PULS:PER? +1.0000E+01 The period is set to 10 seconds.	
	SOURce[1 2]:PULSe:WIDTh	Source Specific Command
Description	Sets or queries the pulse width. The default pulse width is 100us. The minimum pulse width is affected by the period time. If the period is over 20 or 200 seconds, then the minimum pulse width is 1us and 10us, respectively. Pulse width is defined as the time from the rising to falling edges (at a threshold of 50%).	
Note	The pulse width cannot be less than the edge time times 1.6. Pulse Width > 1.6 * Edge Time The pulse width must be less than the period minus the edge time (x1.6). Pulse Width < Period - (1.6 *Edge Time)	
Syntax	SOURce[1 2]:PULSe:WIDTh {<seconds> MINimum MAXimum}	
Example	SOUR1:PULS:WIDT MAX Sets the pulse width to the maximum allowed.	
Query Syntax	SOURce[1 2]:PULSe:WIDTh? [MINimum MAXimum]	
Return Parameter	<seconds>	20 ns ~ 1999.9 seconds
Example	SOUR1:PULS:WIDT? MIN +8.0000E-09 The pulse width is set to 8 nanoseconds.	

Amplitude Modulation (AM) Commands

AM Overview

To successfully create an AM waveform, the following commands must be executed in order.

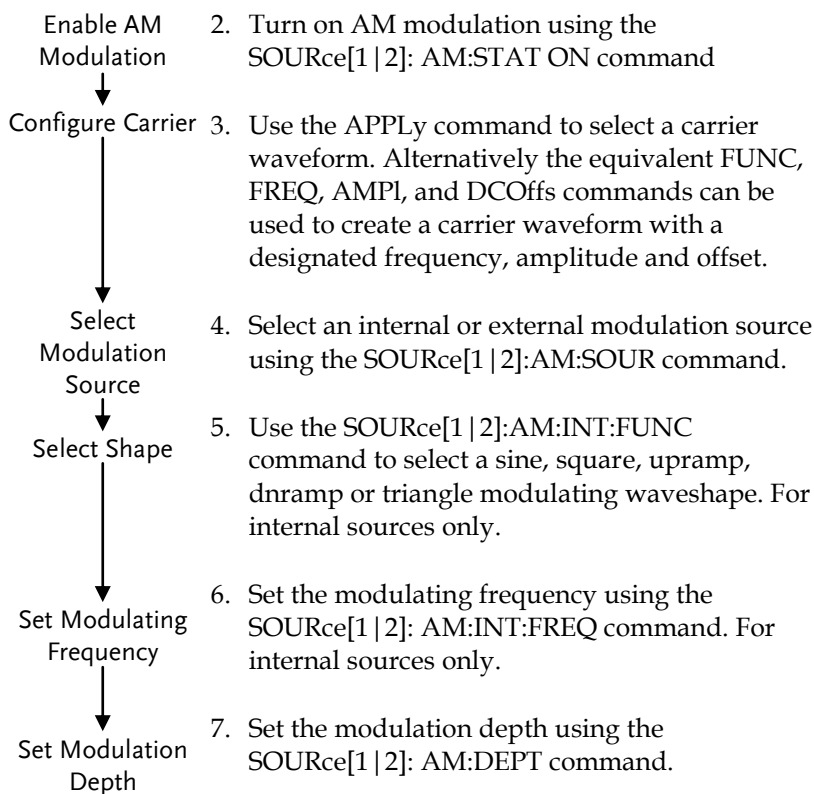

SOURce[1 2]:AM:STATe		Source Specific Command
Description	Sets or disables AM modulation. By default AM modulation is disabled. AM modulation must be enabled before setting other parameters.	
Note	Burst or sweep mode will be disabled if AM modulation is enabled. As only one modulation is allowed at any one time, other modulation modes will be disabled when AM modulation is enabled.	
Syntax	SOURce[1 2]:AM:STATe {OFF ON}	
Example	SOUR1:AM:STAT ON Enables AM modulation.	
Query Syntax	SOURce[1 2]:AM:STATe?	
Return Parameter	0	Disabled (OFF)
	1	Enabled (ON)
Example	SOUR1:AM:STAT? 1 AM modulation mode is currently enabled.	
SOURce[1 2]:AM:SOURce		Source Specific Command
Description	Sets or queries the modulation source as internal or external. Internal is the default modulation source.	
Note	If an external modulation source is selected, modulation depth is limited to $\pm 5V$ from the MOD INPUT terminal on the rear panel. For example, if modulation depth is set to 100%, then the maximum amplitude is +5V, and the minimum amplitude is -5V.	
Syntax	SOURce[1 2]:AM:SOURce {INTernal EXTernal}	

Example **SOUR1:AM:SOUR EXT**

 Sets the modulation source to external.

Query Syntax **SOURce[1|2]:AM:SOURce?**

Return Parameter	INT	Internal
	EXT	External

Example **SOUR1:AM:SOUR?**
INT

 The modulation source is set to internal.

SOURce[1|2]:AM:INTernal:FUNCtion Source Specific Command

Description Sets the shape of the modulating waveform from sine, square, triangle, upramp and dn ramp. The default shape is sine.

Note Square and triangle waveforms have a 50% duty cycle. Upramp and dn ramp have a symmetry of 100% and 0%, respectively.

Syntax **SOURce[1|2]:AM:INTernal:FUNCtion**
{SINusoid|SQUare|TRIangle|UPRamp|DNRamp}

Example **SOUR1:AM:INT:FUNC SIN**

 Sets the AM modulating wave shape to sine.

Query Syntax **SOURce[1|2]:AM:INTernal:FUNCtion?**

Return Parameter	SIN	Sine	UPRAMP	Upramp
	SQU	Square	DNRAMP	Dn ramp
	TRI	Triangle		

Example **SOUR1:AM:INT:FUNC?**
SIN

 The shape for the modulating waveform is Sine.

SOURce[1 2]:AM:INTernal:FREQuency		Source Specific Command
Description	Sets the frequency of the internal modulating waveform only. The default frequency is 100Hz.	
Syntax	SOURce[1 2]:AM:INTernal:FREQuency {<frequency> MINimum MAXimum}	
Parameter	<frequency>	2 mHz~ 20 kHz
Example	SOUR1:AM:INT:FREQ +1.0000E+02 Sets the modulating frequency to 100Hz.	
Query Syntax	SOURce[1 2]:AM:INTernal:FREQuency? [MINimum MAXimum]	
Return Parameter	<NR3>	Returns the frequency in Hz.
Example	SOUR1:AM:INT:FREQ? MIN +1.0000E+02 Returns the minimum frequency allowed.	

SOURce[1 2]:AM:DEPTH		Source Specific Command
Description	Sets or queries the modulation depth for internal sources only. The default is 100%.	
Note	The function generator will not output more than $\pm 5V$, regardless of the modulation depth. The modulation depth of an external source is controlled using the $\pm 5V$ MOD INPUT terminal on the rear panel, and not the SOURce[1 2]:AM:DEPTH command.	
Syntax	SOURce[1 2]:AM:DEPTH {<depth in percent> MINimum MAXimum}	
Parameter	<depth in percent>	0~120%
Example	SOUR1:AM:DEPT 50 Sets the modulation depth to 50%.	

Query Syntax	SOURce[1 2]:AM:DEPT? [MINimum MAXimum]
Return Parameter	<NR3> Return the modulation depth as a percentage.
Example	SOUR1:AM:DEPT? +1.0000E+02 The modulation depth is 100%.

Frequency Modulation (FM) Commands

FM Overview

The following is an overview of the steps required to generate an FM waveform.

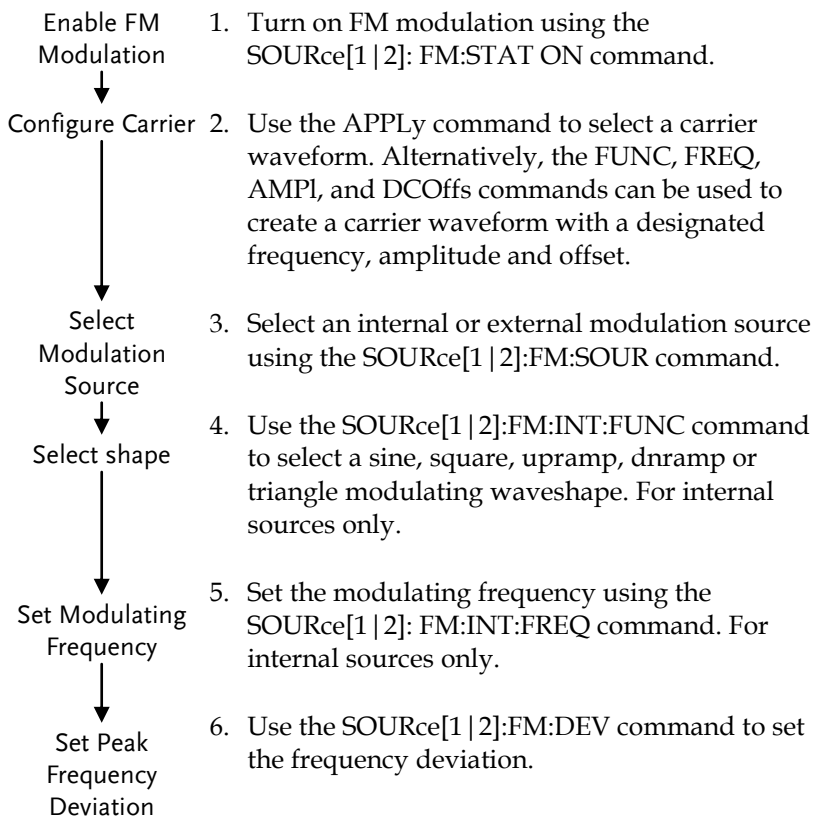

SOURce[1|2]:FM:STATe Source Specific Command

Description Sets or disables FM modulation. By default FM modulation is disabled. FM modulation must be enabled before setting other parameters.

Note Burst or sweep mode will be disabled if FM modulation is enabled. As only one modulation is allowed at any one time, other modulation modes will be disabled when FM modulation is enabled.

Syntax **SOUR[1|2]:FM:STATe {OFF|ON}**

Example **SOUR1:FM:STAT ON**
 Enables FM modulation.

Query Syntax **SOURce[1|2]:FM:STATe?**

Return Parameter 0	Disabled (OFF)
1	Enabled (ON)

Example **SOUR1:FM:STAT?**
1
 FM modulation mode is currently enabled.

SOURce[1|2]:FM:SOURce Source Specific Command

Description Sets or queries the modulation source as internal or external. Internal is the default modulation source.

Note If an external modulation source is selected, modulation depth is limited to $\pm 5V$ from the MOD INPUT terminal on the rear panel. For example, if modulation depth is set to 100%, then the maximum amplitude is +5V, and the minimum amplitude is -5V.

Syntax **SOURce[1|2]:FM:SOURce {INTernal|EXTernal}**

Example	SOUR1:FM:SOUR EXT Sets the modulation source to external.				
Query Syntax	SOURce[1 2]:FM:SOURce?				
Return Parameter	<table border="1"> <tr> <td>INT</td> <td>Internal</td> </tr> <tr> <td>EXT</td> <td>External</td> </tr> </table>	INT	Internal	EXT	External
INT	Internal				
EXT	External				
Example	SOUR1:FM:SOUR? INT The modulation source is set to internal.				

SOURce[1|2]:FM:INTernal:FUNCtion Source Specific Command

Description	Sets the shape of the modulating waveform from sine, square, triangle, upramp and dn ramp. The default shape is sine.														
Note	Square and triangle waveforms have a 50% duty cycle. Upramp and dn ramp have a symmetry of 100% and 0%, respectively.														
Syntax	SOURce[1 2]:FM:INTernal:FUNCtion {SINusoid SQUare TRIangle UPRamp DNRamp}														
Example	SOUR1:FM:INT:FUNC SIN Sets the FM modulating wave shape to sine.														
Query Syntax	SOURce[1 2]:FM:INTernal:FUNCtion?														
Return Parameter	<table border="1"> <tr> <td>SIN</td> <td>Sine</td> <td>UPRAMP</td> <td>Upramp</td> </tr> <tr> <td>SQU</td> <td>Square</td> <td>DNRAMP</td> <td>Dn ramp</td> </tr> <tr> <td>TRI</td> <td>Triangle</td> <td></td> <td></td> </tr> </table>	SIN	Sine	UPRAMP	Upramp	SQU	Square	DNRAMP	Dn ramp	TRI	Triangle				
SIN	Sine	UPRAMP	Upramp												
SQU	Square	DNRAMP	Dn ramp												
TRI	Triangle														
Example	SOUR1:FM:INT:FUNC? SIN The shape for the modulating waveform is Sine.														

SOURce[1 2]:FM:INTernal:FREQUENCY		Source Specific Command
Description	Sets the frequency of the internal modulating waveform only. The default frequency is 10Hz.	
Syntax	SOURce[1 2]:FM:INTernal:FREQUENCY {<frequency> MINimum MAXimum}	
Parameter	<frequency>	2 mHz~ 20 kHz
Example	SOUR1:FM:INT:FREQ 100 Sets the modulating frequency to 100Hz.	
Query Syntax	SOURce[1 2]:FM:INTernal:FREQUENCY? [MINimum MAXimum]	
Return Parameter	<NR3>	Returns the frequency in Hz.
Example	SOUR1:FM:INT:FREQ? MAX +2.0000E+04 Returns the maximum frequency allowed.	

SOURce[1 2]:FM:DEVIation		Source Specific Command
Description	Sets or queries the peak frequency deviation of the modulating waveform from the carrier waveform. The default peak deviation is 100Hz. The frequency deviation of external sources is controlled using the $\pm 5V$ MOD INPUT terminal on the rear panel. A positive signal ($>0\sim+5V$) will increase the deviation (up to the set frequency deviation), whilst a negative voltage will reduce the deviation.	
Note	The relationship of peak deviation to modulating frequency and carrier frequency is shown below. Peak deviation = modulating frequency - carrier frequency. The carrier frequency must be greater than or	

equal to the peak deviation frequency. The sum of the deviation and carrier frequency must not exceed the maximum frequency for a specific carrier shape. If an out of range deviation is set for any of the above conditions, the deviation will be automatically adjusted to the maximum value allowed and an “out of range” error will be generated.

For square wave carrier waveforms, the deviation may cause the duty cycle frequency boundary to be exceeded. In these conditions the duty cycle will be adjusted to the maximum allowed and a “settings conflict” error will be generated.

Syntax	SOURce[1 2]:FM:DEVIation {<peak deviation in Hz> MINimum MAXimum}	
Parameter	<peak deviation in Hz>	DC~25MHz DC~15MHz(square) DC~1MHz (Ramp)
Example	SOUR1:FM:DEV MAX Sets the frequency deviation to the maximum value allowed.	
Query Syntax	SOURce[1 2]:FM:DEVIation? [MINimum MAXimum]	
Return Parameter	<NR3>	Returns the frequency deviation in Hz.
Example	SOURce[1 2]:FM:DEVIation? MAX +1.0000E+01 Returns the maximum frequency deviation allowed.	

Frequency-Shift Keying (FSK) Commands

FSK Overview

The following is an overview of the steps required to generate an FSK modulated waveform.

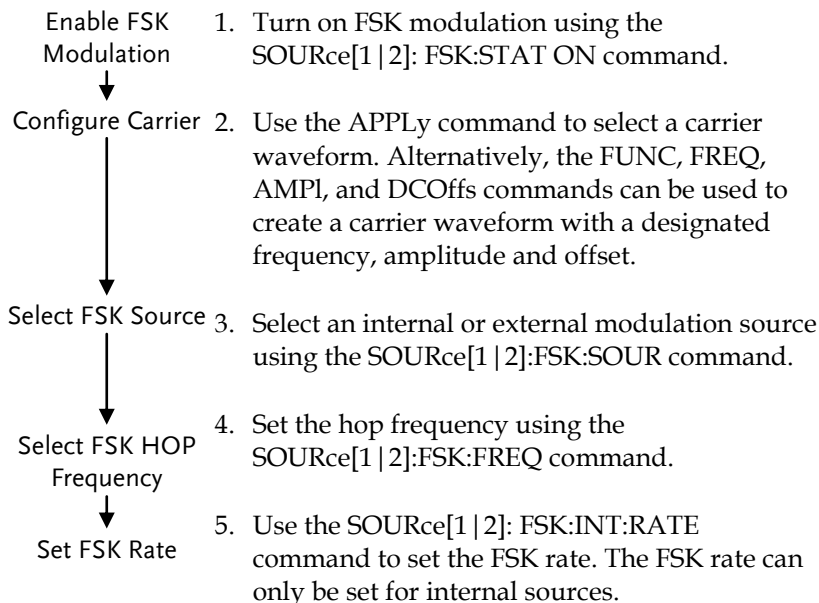

SOURce[1 2]:FSKey:STATe		Source Specific Command
Description	Turns FSK Modulation on or off. By default FSK modulation is off.	
Note	Burst or sweep mode will be disabled if FSK modulation is enabled. As only one modulation is allowed at any one time, other modulation modes will be disabled when FSK modulation is enabled.	
Syntax	SOURce[1 2]:FSKey:STATe {OFF ON}	
Example	SOUR1:FSK:STAT ON	

	Enables FSK modulation	
Query Syntax	SOURce[1 2]:FSKey:STATe?	
Return Parameter	0	Disabled (OFF)
	1	Enabled (ON)
Example	SOUR1:FSK:STAT? 1 FSK modulation is currently enabled.	

SOURce[1|2]:FSKey:SOURce Source Specific Command

Description	Sets or queries the FSK source as internal or external. Internal is the default source.	
Note	If an external FSK source is selected, FSK rate is controlled by the Trigger INPUT terminal on the rear panel.	
Syntax	SOURce[1 2]:FSKey:SOURce {INTernal EXTernal}	
Example	SOUR1:FSK:SOUR EXT Sets the FSK source to external.	
Query Syntax	SOURce[1 2]:FSKey:SOURce?	
Return Parameter	INT	Internal
	EXT	External
Example	SOUR1:FSK:SOUR? INT The FSK source is set to internal.	

SOURce[1|2]:FSKey:FREQuency Source Specific Command

Description	Sets the FSK hop frequency. The default hop frequency is set to 100Hz.	
Note	For FSK, the modulating waveform is a square wave with a duty cycle of 50%.	

Syntax	SOURce[1 2]:FSKey:FREQuency {<frequency> MINimum MAXimum}	
Parameter	<frequency>	1 μHz~25MHz(sine) 1 μHz~15MHz(Square、Pulse) 1 μHz~1MHz(Ramp)
Example	SOUR1:FSK:FREQ +1.0000E+02 Sets the FSK hop frequency to to 100Hz.	
Query Syntax	SOURce[1 2]:FSKey:FREQuency? [MINimum MAXimum]	
Return Parameter	<NR3>	Returns the frequency in Hz.

Example	SOUR1:FSK:FREQ? MAX +2.5000E+06 Returns the maximum hop frequency allowed.	
---------	--	--

SOURce[1|2]:FSKey:INTernal:RATE Source Specific Command

Description	Sets or queries the FSK rate for internal sources only.	
Note	External sources will ignore this command.	
Syntax	SOURce[1 2]:FSKey:INTernal:RATE {<rate in Hz> MINimum MAXimum}	
Parameter	<rate in Hz>	2 mHz~100 kHz
Example	SOUR1:FSK:INT:RATE MAX Sets the rate to the maximum (100kHz).	
Query Syntax	SOURce[1 2]:FSKey:INTernal:RATE? [MINimum MAXimum]	
Return Parameter	<NR3>	Returns the FSK rate in Hz.

Example

SOUR1:FSK:INT:RATE? MAX

+1.0000E+05

Returns the maximum FSK rate allowed.

Phase Modulation (PM) Commands

PM Overview

The following is an overview of the steps required to generate a PM modulated waveform.

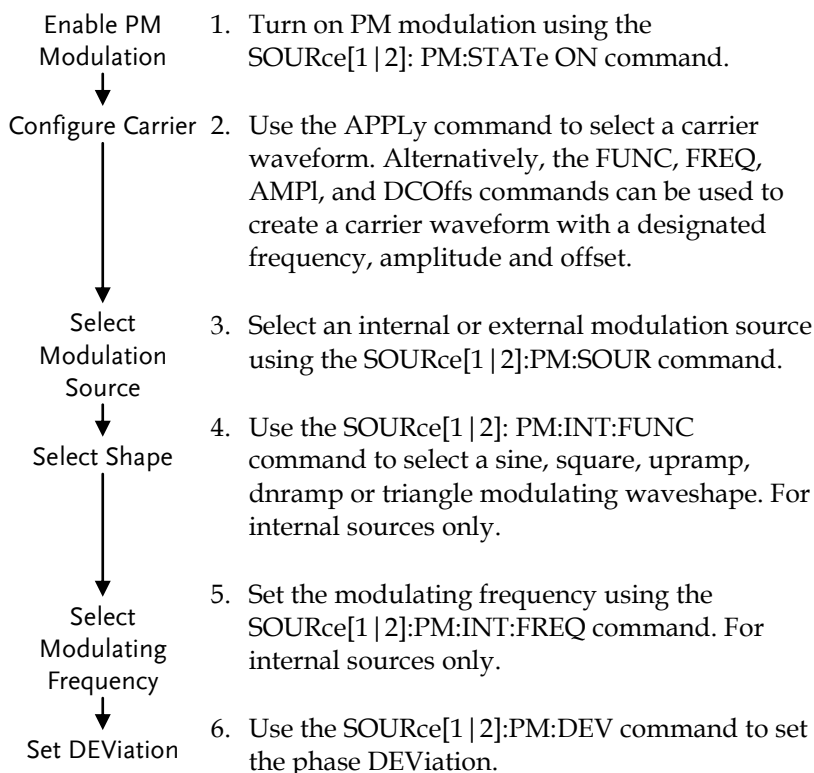

SOURce[1|2]:PM:STATe Source Specific Command

Description Turns PM Modulation on or off. By default PM modulation is off.

Note Burst or sweep mode will be disabled if PM modulation is enabled. As only one modulation is allowed at any one time, other modulation modes will be disabled when PM modulation is enabled.

Syntax **SOURce[1|2]:PM:STATe {OFF|ON}**

Example **SOUR1:PM:STAT ON**
Enables PM modulation

Query Syntax **SOURce[1|2]:PM:STATe?**

Return Parameter	0	Disabled (OFF)
	1	Enabled (ON)

Example **SOUR1:PM:STAT?**
1
PM modulation is currently enabled.

SOURce[1|2]:PM:SOURce Source Specific Command

Description Sets or queries the PM source as internal or external. Internal is the default source.

Note If an external PM source is selected, the phase modulation is controlled by the MOD INPUT terminal on the rear panel.

Syntax **SOURce[1|2]:PM:SOURce {INTernal|EXTernal}**

Example **SOUR1:PM:SOUR EXT**
Sets the PM source to external.

Query Syntax **SOURce[1|2]:PM:SOURce?**

Return Parameter	INT	Internal
	EXT	External

Example **SOUR1:PM:SOUR?**
INT
 The PM source is set to internal.

SOURce[1|2]:PM:INTernal:FUNction Source Specific Command

Description Sets the shape of the modulating waveform from sine, square, triangle, upramp and dn ramp. The default shape is sine.

Note Square and triangle waveforms have a 50% duty cycle. Upramp and dn ramp have a symmetry to 100% and 0%, respectively. .

Syntax **SOURce[1|2]:PM:INTernal:FUNction**
{SINusoid|SQUare|TRIangle|UPRamp|DNRamp}

Example **SOUR1:PM:INT:FUN SIN**
 Sets the PM modulating wave shape to sine. .

Query Syntax **SOURce[1|2]:PM:INTernal:FUNction?**

Return Parameter	SIN	Sine	UPRAMP	Upramp
	SQU	Square	DNRAMP	Dn ramp
	TRI	Triangle		

Example **SOUR1:PM:INT:FUNC?**
SIN
 The shape for the modulating waveform is Sine.

SOURce[1|2]:PM:INTernal:FREQuency Source Specific Command

Description Sets the modulating waveform frequency for internal sources. The default frequency is set to 100Hz.

Syntax **SOURce[1|2]:PM:INTernal:FREQuency**
{<frequency>|MINimum|MAXimum}

Parameter <frequency> 2 mHz~ 20 kHz

Example **SOUR1:PM:INT:FREQ MAX**
 Sets the frequency to the maximum value.

Query Syntax **SOURce[1|2]:PM:INTernal:FREQuency?**

Return Parameter <NR3> Returns the frequency in Hz.

Example **SOUR1:PM:INT:FREQ? MAX**
+2.0000E+04
 Returns the modulating frequency. (20kHz)

SOURce[1|2]:PM:DEVIation Source Specific Command

Description Sets or queries the phase deviation of the modulating waveform from the carrier waveform. The default phase deviation is 180°.

Note For external sources, the phase deviation is controlled by the ±5V MOD Input terminal on the rear panel. If the phase deviation is set to 180 degrees, then +5V represents a deviation of 180 degrees. A lower input voltage will decrease the set phase deviation.

Syntax **SOURce[1|2]:PM:DEVIation {< phase>|minimum |maximum}**

Parameter <percent> 0°~360°

Example **SOUR1:PM:DEVIation +3.0000E+01**
 Sets the deviation to 30°.

Query Syntax **SOURce[1|2]:PM:DEVIation?**

Return Parameter <NR3> Returns the deviation .

Example **SOUR1:PM:DEVIation?**
+3.0000E+01
 The current deviation is 30°.

SUM Modulation (SUM) Commands

SUM Overview

The following is an overview of the steps required to generate a SUM modulated waveform.

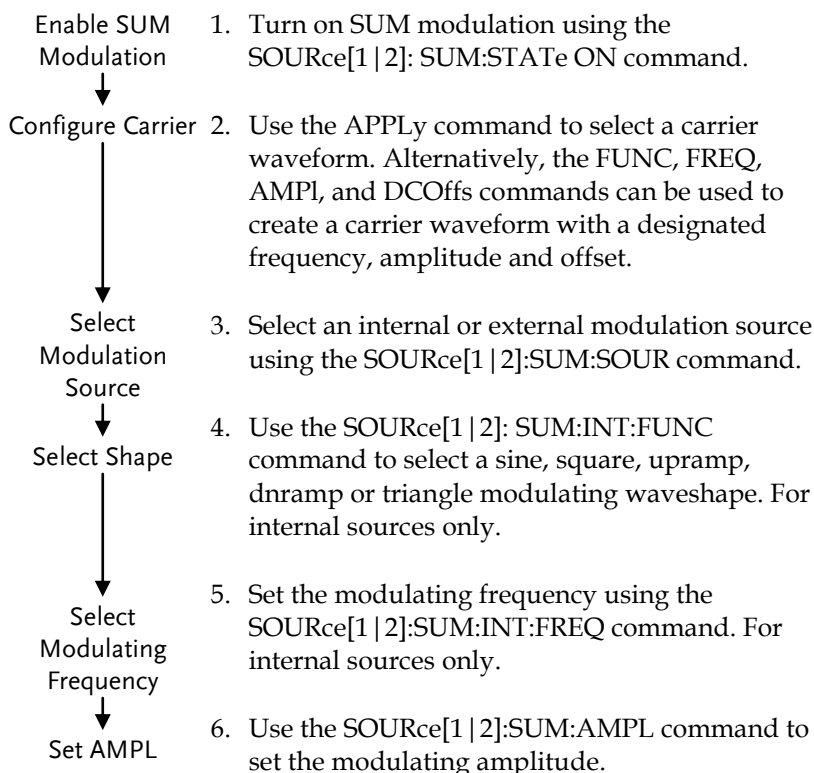

SOURce[1|2]:SUM:STATe Source Specific Command

Description Turns SUM Modulation on or off. By default SUM modulation is off.

Note Burst or sweep mode will be disabled if SUM modulation is enabled. As only one modulation is allowed at any one time, other modulation modes will be disabled when SUM modulation is enabled.

Syntax **SOURce[1|2]:SUM:STATe {OFF|ON}**

Example **SOUR1:SUM:STAT ON**
Enables SUM modulation

Query Syntax **SOURce[1|2]:SUM:STATe?**

Return Parameter 0 Disabled (OFF)

1 Enabled (ON)

Example **SOUR1:SUM:STAT?**
ON
SUM modulation is currently enabled.

SOURce[1|2]:SUM:SOURce Source Specific Command

Description Sets or queries the SUM source as internal or external. Internal is the default source.

Note If an external SUM source is selected, the amplitude is controlled by the MOD INPUT terminal on the rear panel.

Syntax **SOURce[1|2]:SUM:SOURce {INTernal|EXTernal}**

Example **SOUR1:SUM:SOUR EXT**
Sets the SUM source to external.

Query Syntax **SOURce[1|2]:SUM:SOURce?**

Return Parameter INT Internal

	EXT			External
--	-----	--	--	----------

Example **SOUR1:SUM:SOUR?**
INT
 The SUM source is set to internal.

SOURce[1 2]:SUM:INTernal:FUNction	Source Specific Command
--	-------------------------

Description Sets the shape of the modulating waveform from sine, square, triangle, upramp and dnramp. The default shape is sine.

Note Square and triangle waveforms have a 50% duty cycle. Upramp and dnramp have a symmetry to 100% and 0%, respectively. .

Syntax **SOURce[1|2]:SUM:INTernal:FUNction**
{SINusoid|SQUare|TRIangle|UPRamp|DNRamp}

Example **SOUR1:SUM:INT:FUN SIN**
 Sets the SUM modulating wave shape to sine.

Query Syntax **SOURce[1|2]:SUM:INTernal:FUNction?**

Return Parameter	SIN	Sine	UPRAMP	Upramp
	SQU	Square	DNRAMP	Dnramp
	TRI	Triangle		

Example **SOUR1:SUM:INT:FUNC?**
SIN
 The shape for the modulating waveform is Sine.

SOURce[1 2]:SUM:INTernal:FREQuency	Source Specific Command
---	-------------------------

Description Sets the modulating waveform frequency for internal sources. The default frequency is set to 100Hz.

Syntax **SOURce[1|2]:SUM:INTernal:FREQuency**
{<frequency>|MINimum|MAXimum}

Parameter	<frequency>	2 mHz~ 20 kHz
Example	SOUR1:SUM:INT:FREQ MAX Sets the frequency to the maximum value.	
Query Syntax	SOURce[1 2]:SUM:INTernal:FREQuency?	
Return Parameter	<NR3>	Returns the frequency in Hz.
Example	SOUR1:SUM:INT:FREQ? MAX +2.0000E+04 Returns the modulating frequency (20kHz).	

SOURce[1|2]:SUM:AMPL Source Specific Command

Description	Sets or queries the amplitude of the modulating waveform from the carrier waveform. The default phase amplitude is 50%.	
Note	If an external SUM source is selected, the amplitude of the modulated waveform is controlled using the $\pm 5V$ MOD INPUT terminal on the rear panel. A positive signal ($>0\sim+5V$) will increase the AMPLitude (up to the set amplitude), whilst a negative voltage will reduce the amplitude.	
Syntax	SOURce[1 2]:SUM:AMPL{< percent> minimum maximum}	
Parameter	<percent>	0%~100%
Example	SOUR1:SUM:AMPLitude +3.0000E+01 Sets the amplitude to 30%.	
Query Syntax	SOURce[1 2]:SUM:AMPLitude?	
Return Parameter	<NR3>	Returns the amplitude .
Example	SOUR1:SUM:AMPLitude? +3.0000E+01 The current amplitude is 30%.	

Frequency Sweep Commands

Sweep Overview

Below shows the order in which commands must be executed to perform a sweep.

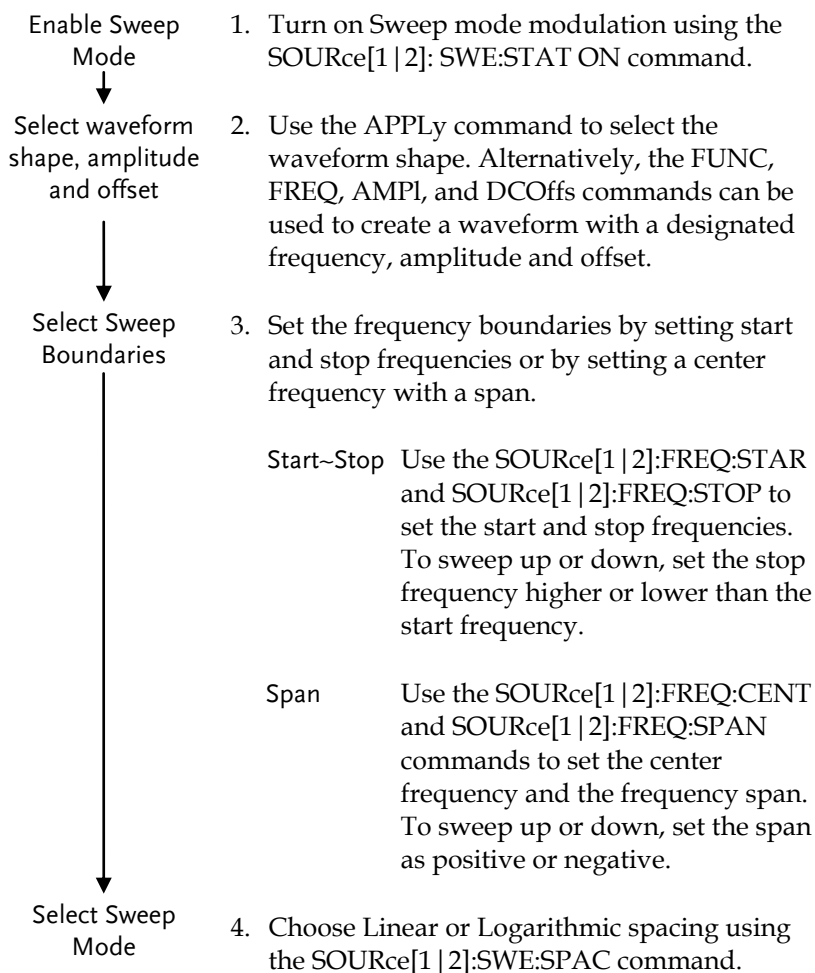

- | | |
|---|--|
| Select Sweep Time
↓
Select the sweep trigger source
↓
Select the marker frequency | 5. Choose the sweep time using the <code>SOURce[1 2]:SWE:TIME</code> command.

6. Select an internal or external sweep trigger source using the <code>SOURce[1 2]:SOUR</code> command.

7. To output a marker frequency from the trigger out, use The <code>SOURce[1 2]:MARK:FREQ</code> command. To enable marker frequency output, use the <code>SOURce[1 2]:MARK ON</code> command. |
|---|--|

The marker frequency can be set to a value within the sweep span.

	Source Specific Command
<code>SOURce[1 2]:SWEep:STATe</code>	
Description	Sets or disables Sweep mode. By default Sweep is disabled. Sweep modulation must be enabled before setting other parameters.
Note	Any modulation modes or Burst mode will be disabled if sweep mode is enabled.
Syntax	<code>SOURce[1 2]:SWEep:STATe {OFF ON}</code>
Example	<code>SOUR1:SWE:STAT ON</code> Enables sweep mode.
Query Syntax	<code>SOURce[1 2]:SWEep:STATe?</code>
Return Parameter	0 Disabled (OFF)
	1 Enabled (ON)
Example	<code>SOUR1:SWE:STAT?</code> 1 Sweep mode is currently enabled.

SOURce[1|2]:FREQuency:STARt Source Specific Command

Description	Sets the start frequency of the sweep. 100Hz is the default start frequency.	
Note	To sweep up or down, set the stop frequency higher or lower than the start frequency.	
Syntax	SOURce[1 2]:FREQuency:STARt {<frequency> MINimum MAXimum}	
Parameter	<frequency>	1μHz~ 25MHz 1μHz~ 15MHz(Square) 1μHz~ 1MHz (Ramp)
Example	SOUR1:FREQ:STAR +2.0000E+03 Sets the start frequency to 2kHz.	
Query Syntax	SOURce[1 2]:FREQuency:STARt? [MINimum MAXimum]	
Return Parameter	<NR3>	Returns the start frequency in Hz.
Example	SOUR1:FREQ:STAR? MAX +8.0000E+0 Returns the maximum start frequency allowed.	

SOURce[1|2]:FREQuency:STOP Source Specific Command

Description	Sets the stop frequency of the sweep. 1 kHz is the default start frequency.	
Note	To sweep up or down, set the stop frequency higher or lower than the start frequency.	
Syntax	SOURce[1 2]:FREQuency:STOP {<frequency> MINimum MAXimum}	

Parameter	<frequency>	1μHz~ 25MHz 1μHz~ 15MHz(Square) 1μHz~ 1MHz (Ramp)
Example	SOUR1:FREQ:STOP +2.0000E+03 Sets the stop frequency to 2kHz.	
Query Syntax	SOURce[1 2]:FREQuency:STOP? [MINimum MAXimum]	
Return Parameter	<NR3>	Returns the stop frequency in Hz.
Example	SOUR1:FREQ:STOP? MAX +8.0000E+00 Returns the maximum stop frequency allowed.	
SOURce[1 2]:FREQuency:CENTer		Source Specific Command
Description	Sets and queries the center frequency of the sweep. 550 Hz is the default center frequency.	
Note	The maximum center frequency depends on the sweep span and maximum frequency: max center freq = max freq - span/2	
Syntax	SOURce[1 2]:FREQuency:CENTer {<frequency> MINimum MAXimum}	
Parameter	<frequency>	450Hz~ 25MHz 450Hz~ 15MHz(Square) 450Hz~ 1MHz (Ramp)
Example	SOUR1:FREQ:CENt +2.0000E+03 Sets the center frequency to 2kHz.	
Query Syntax	SOURce[1 2]:FREQuency:CENTer? [MINimum MAXimum]	
Return Parameter	<NR3>	Returns the stop frequency in Hz.

Example **SOUR1:FREQ:CENT? MAX**
+8.0000E+00

Returns the maximum center frequency allowed, depending on the span.

SOURce[1|2]:FREQuency:SPAN

Source Specific
Command

Description Sets and queries the frequency span of the sweep. 900 Hz is the default frequency span. The span frequency is equal to the stop-start frequencies.

Note To sweep up or down, set the span as positive or negative.

The maximum span frequency has a relationship to the center frequency and maximum frequency:
 $\text{max freq span} = 2(\text{max freq} - \text{center freq})$

Syntax **SOURce[1|2]:FREQuency:SPAN**
{<frequency>|MINimum|MAXimum}

Parameter <frequency>

1μHz~ 25MHz
1μHz~ 15MHz(Square)
1μHz~ 1MHz (Ramp)

Example **SOUR1:FREQ:SPAN +2.0000E+03**

Sets the frequency span to 2kHz.

Query Syntax **SOURce[1|2]:FREQuency:SPAN? [MINimum|MAXimum]**

Return Parameter <NR3>

Returns the frequency span in Hz.

Example **SOUR1:FREQ:SPAN?**
+2.0000E+03

Returns the frequency span for the current sweep.

SOURce[1|2]:SWEep:SPACing Source Specific Command

Description	Sets linear or logarithmic sweep spacing. The default spacing is linear.	
Syntax	SOURce[1 2]:SWEep:SPACing {LINear LOGarithmic}	
Example	SOUR1:SWE:SPAC LIN Sets the spacing to linear.	
Query Syntax	SOURce[1 2]:SWEep:SPACing?	
Return Parameter	LIN	Linear spacing
	LOG	Logarithmic spacing
Example	SOUR1:SWE:SPAC? LIN The spacing is currently set as linear.	

SOURce[1|2]:SWEep:TIME Source Specific Command

Description	Sets or queries the sweep time. The default sweep time is 1 second.	
Note	The function generator automatically determines the number of frequency points that are used for the sweep based on the sweep time.	
Syntax	SOURce[1 2]:SWEep:TIME {<seconds> MINimum MAXimum}	
Parameter	<seconds>	1 ms ~ 500 s
Example	SOUR1:SWE:TIME +1.0000E+00 Sets the sweep time to 1 second.	
Query Syntax	SOURce[1 2]:SWEep:TIME? {<seconds> MINimum MAXimum}	
Return Parameter	<NR3>	Returns sweep time in seconds.

SOURce[1|2]:MARKer:FREQuency Source Specific Command

Description Sets or queries the marker frequency. The default marker frequency is 550 Hz. The marker frequency is used to output a trigger out signal from the trigger terminal on the rear panel.

Note The marker frequency must be between the start and stop frequencies. If the marker frequency is set to a value that is out of the range, the marker frequency will be set to the center frequency and a “settings conflict” error will be generated.

Syntax **SOURce[1|2]:MARKer:FREQuency {<frequency>|MINimum|MAXimum}**

Parameter <frequency> 1 μHz ~ 25 MHz
1 μHz ~ 1 MHz (Ramp)

Example **SOUR1:MARK:FREQ +1.0000E+03**
Sets the marker frequency to 1 kHz.

Query Syntax **SOURce[1|2]:MARKer:FREQuency? [MINimum] MAXimum]**

Return Parameter <NR3> Returns the marker frequency in Hz.

Example **SOUR1:MARK:FREQ? MAX +1.0000E+03**
Returns the marker frequency (1 kHz).

SOURce[1|2]:MARKer Source Specific Command

Description Turns the marker frequency on or off. The default is off.

Note **MARKer ON** The SYNC signal goes logically high at the start of each sweep and goes low at the marker frequency.

MARKer OFF The SYNC terminal outputs a square wave with a 50% duty cycle at the start of each sweep.

Syntax **SOURce[1|2]:MARKer {OFF|ON}**

Example **SOUR1:MARK ON**
 Enables the marker frequency.

Query Syntax **SOURce[1|2]:MARKer?**

Return Parameter	0	Disabled
	1	Enabled

Example **SOUR1:MARK?**
1
 The marker frequency is enabled.

Burst Mode Commands

Burst Mode Overview

Burst mode can be configured to use an internal trigger (N Cycle mode) or an external trigger (Gate mode) using the Trigger INPUT terminal on the rear panel. Using N Cycle mode, each time the function generator receives a trigger, the function generator will output a specified number of waveform cycles (burst). After the burst, the function generator will wait for the next trigger before outputting another burst. N Cycle is the default Burst mode.

The alternative to using a specified number of cycles, Gate mode uses the external trigger to turn on or off the output. When the Trigger INPUT signal is high*, waveforms are continuously output (creating a burst). When the Trigger INPUT signal goes low*, the waveforms will stop being output after the last waveform completes its period. The voltage level of the output will remain equal to the starting phase of the burst waveforms, ready for the signal to go high* again.

*assuming the Trigger polarity is not inverted.

Only one burst mode can be used at any one time. The burst mode depends on the source of the trigger (internal, external, manual) and the source of the burst.

Burst Mode & Source	Function		
	N Cycle*	Cycle	Phase
Triggered – IMMEDIATE, BUS	Available	Available	Available
Triggered - EXTERNAL, MANUAL	Available	Unused	Available
Gated pulse - IMMEDIATE	Unused	Unused	Available

*burst count

The following is an overview of the steps required to generate a burst waveform.

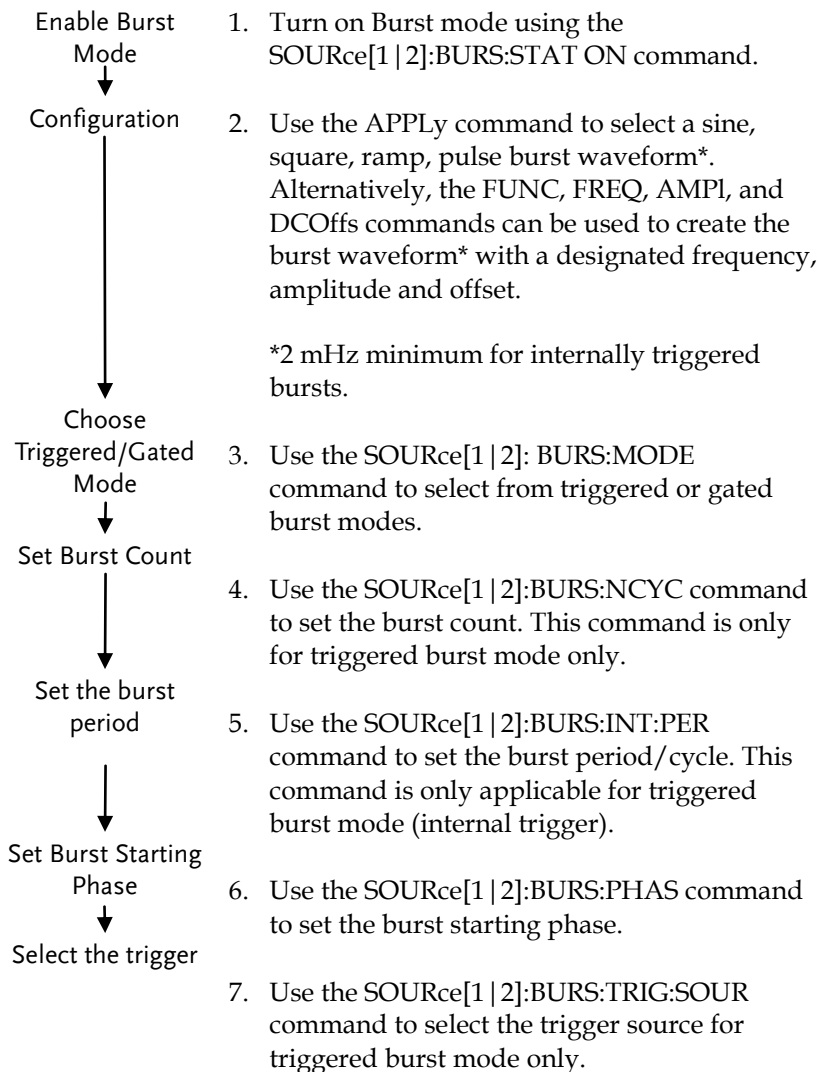

SOURce[1|2]:BURSt:STATe Source Specific Command

Description	Turns burst mode on or off. By default burst mode is turned off.
Note	When burst mode is turned on, sweep and any modulation modes are disabled.
Syntax	SOURce[1 2]:BURSt:STATe {OFF ON}
Example	SOUR1:BURS:STAT ON Turns burst mode on.
Query Syntax	SOURce[1 2]:BURSt:STATe?
Return Parameter	0 Disabled 1 Enabled
Example	SOUR1:BURS:STAT? 0 Burst mode is off.

SOURce[1|2]:BURSt:MODE Source Specific Command

Description	Sets or queries the burst mode as gated or triggered. The default burst mode is triggered.
Note	The burst count, period, trigger source and any manual trigger commands are ignored in gated burst mode.
Syntax	SOURce[1 2]:BURSt:MODE {TRIGgered GATed}
Example	SOUR1:BURS:MODE TRIG Sets the burst mode to triggered.
Query Syntax	SOURce[1 2]:BURSt:MODE?
Return Parameter	TRIG Triggered mode GAT Gated mode

Example **SOUR1:BURS:MODE?**
TRIG
 The current burst mode is triggered.

SOURce[1|2]:BURSt:NCYCles Source Specific Command

Description Sets or queries the number of cycles (burst count) in triggered burst mode. The default number of cycles is 1. The burst count is ignored in gated mode.

Note If the trigger source is set to immediate, the product of the burst period and waveform frequency must be greater than the burst count:
 Burst Period X Waveform frequency > burst count
 If the burst count is too large, the burst period will automatically be increased and a “Settings conflict” error will be generated.
 Only sine and square waves are allowed infinite burst above 25 MHz.

Syntax **SOURce[1|2]:BURSt:NCYCles{< # cycles> |INFinity|MINimum |MAXimum}**

Parameter	<# cycles>	1~65535 cycles.
	INFinity	Sets the number to continuous.
	MINimum	Sets the number to minimum allowed.
	MAXimum	Sets the number to maximum allowed.

Example **SOUR1:BURS:NCYCl INF**
 Sets the number of burst cycles to continuous (infinite).

Query Syntax **SOURce[1|2]:BURSt:NCYCles? [MINimum|MAXimum]**

Return Parameter	<NR3>	Returns the number of cycles.
	INF	INF is returned if the number of cycles is continuous.

Example	SOUR1:BURS:NCYC? +1.0000E+02 The burst cycles are set to 100.	
	SOURce[1 2]:BURSt:INTernal:PERiod	Source Specific Command
Description	Sets or queries the burst period. Burst period settings are only applicable when the trigger is set to immediate. The default burst period is 10 ms. During manual triggering, external triggering or Gate burst mode, the burst period settings are ignored.	
Note	The burst period must be long enough to output the designated number of cycles for a selected frequency. Burst period > burst count / (waveform frequency + 200 ns) If the period is too short, it is automatically increased so that a burst can be continuously output. A "data out of range" error will also be generated.	
Syntax	SOURce[1 2]:BURSt:INTernal:PERiod {<seconds> MINimum MAXimum}	
Parameter	<seconds > 1 ms ~ 500 seconds	
Example	SOUR1:BURS:INT:PER +1.0000E+01 Sets the period to 10 seconds.	
Query Syntax	SOURce[1 2]:BURSt:INTernal:PERiod? [MINimum MAXimum]	
Return Parameter	<NR3> Returns the burst period in seconds.	
Example	SOUR1:BURS:INT:PER? +1.0000E+01 The burst period is 10 seconds.	

SOURce[1|2]:BURSt:PHASe Source Specific Command

Description	<p>Sets or queries the starting phase for the burst. The default phase is 0 degrees. At 0 degrees, sine square and ramp waveforms are at 0 volts.</p> <p>In gated burst mode, waveforms are continuously output (burst) when the Trig signal is true. The voltage level at the starting phase is used to determine the voltage level of the signal in-between bursts.</p>
Note	<p>The phase command is not used with pulse waveforms.</p>
Syntax	<p>SOURce[1 2]:BURSt:PHASe {<angle> MINimum MAXimum}</p>
Parameter	<p><angle> -360 ~ 360 degrees</p>
Example	<p>SOUR1:BURSt:PHAS MAX</p> <p>Sets the phase to 360 degrees.</p>
Query Syntax	<p>SOURce[1 2]:BURSt:PHASe? [MINimum MAXimum]</p>
Return Parameter	<p><NR3> Returns the phase angle in degrees.</p>
Example	<p>SOUR1:BURSt:PHAS? +1.2000E+02</p> <p>The burst phase is 120 degrees.</p>

SOURce[1|2]:BURSt:TRIGger:SOURce Source Specific Command

Description	<p>Sets or queries the trigger source for triggered burst mode. In triggered burst mode, a waveform burst is output each time a trigger signal is received and the number of cycles is determined by the burst count.</p> <p>There are three trigger sources for triggered burst mode:</p>
-------------	--

	Immediate	A burst is output at a set frequency determined by the burst period.
	External	EXTERNAL will output a burst waveform after each external trigger pulse. Any additional trigger pulse signals before the end of the burst are ignored.
	Manual	Manual triggering will output a burst waveform after the trigger softkey is pressed.
Note	<p>If the APPLY command was used, the source is automatically set to IMMEDIATE.</p> <p>The *OPC/*OPC? command/query can be used to signal the end of the burst.</p>	
Syntax	SOURCE[1 2]:BURSt:TRIGger:SOURce {IMMEDIATE EXTERNAL MANual}	
Example	<p>SOUR1:BURS:TRIG:SOUR EXT</p> <p>Sets the burst trigger source to external.</p>	
Query Syntax	SOURCE[1 2]:BURSt:TRIGger:SOURce?	
Return Parameter	IMM	Immediate
	EXT	External
	MANual	Manual
Example	<p>SOUR1:BURS:TRIG:SOUR?</p> <p>IMM</p> <p>The burst trigger source is set to immediate.</p>	
	SOURCE[1 2]:BURSt:TRIGger:DELay	Source Specific Command
Description	<p>The DELAY command is used to insert a delay (in seconds) before a burst is output. The delay starts after a trigger is received. The default delay is 0 seconds.</p>	

Syntax	SOURce[1 2]: BURSt:TRIGger:DElay {<seconds> MINimum MAXimum}	
Parameter	<seconds>	0~655350 nS
Example	SOUR1:BURS:TRIG:DEL +1.0000E+01 Sets the trigger delay to 10 seconds.	
Query Syntax	SOURce[1 2]:BURSt:TRIGger:DElay? [MINimum MAXimum]	
Return Parameter	<NRf>	Delay in seconds
Example	SOUR1:BURS:TRIG:DEL ? +1.0000E+01 The trigger delay is 10 seconds.	

SOURce[1|2]:BURSt:TRIGger:SLOPe Source Specific Command

Description	Sets or queries the trigger edge for externally triggered bursts from the Trigger INPUT terminal on the rear panel. By default the trigger is rising edge (Positive).	
Syntax	SOURce[1 2]:BURSt:TRIGger:SLOPe {POSitive NEGative}	
Parameter	POSitive	rising edge
	NEGative	falling edge
Example	SOUR1:BURS:TRIG:SLOP NEG Sets the trigger slope to negative.	
Query Syntax	SOURce[1 2]:BURSt:TRIGger:SLOPe?	
Return Parameter	POS	rising edge
	NEG	falling edge
Example	SOUR1:BURS:TRIG:SLOP ? NEG The trigger slope is negative.	

SOURce[1|2]:BURSt:GATE:POLarity Source Specific Command

Description In gated mode, the function generator will output a waveform continuously while the external trigger receives logically true signal from the Trigger INPUT terminal. Normally a signal is logically true when it is high. The logical level can be inverted so that a low signal is considered true.

Syntax **SOURce[1|2]:BURSt:GATE:POLarity {NORMAL|INVertes}**

Parameter	NORMAL	Logically high
	INVertes	Logically low

Example **SOUR1:BURSt:GATE:POL INV**
Sets the state to logically low (inverted).

Query Syntax **SOURce[1|2]:BURSt:GATE:POLarity?**

Return Parameter	NORM	Normal(High) logical level
	INV	Inverted (low) logical level

Example **SOUR1:BURSt:GATE:POL?**
INV
The true state is inverted(logically low).

SOURce[1|2]:BURSt:OUTPut:TRIGger:SLOPe Source Specific Command

Description Sets or queries the trigger edge of the trigger output signal. The signal is output from the trigger out terminal on the rear panel. The default trigger output slope is positive.

Immediate	50% duty cycle square wave is output at the start of each burst.
-----------	--

External	Trigger output disabled.
----------	--------------------------

Gated mode	Trigger output disabled.
------------	--------------------------

	Manual	A >1 ms pulse is output at the start of each burst.
Syntax	SOURce[1 2]:BURSt:OUTPut:TRIGger:SLOPe {POSitive NEGative}	
Parameter	POSitive	Rising edge.
	NEGative	Falling edge.
Example	SOUR1:BURSt:OUTP:TRIG:SLOP POS Sets the trigger output signal slope to positive (rising edge).	
Query Syntax	SOURce[1 2]:BURSt:OUTPut:TRIGger:SLOPe?	
Return Parameter	POS	Rising edge.
	NEG	Falling edge.
Example	SOUR1:BURSt:OUTP:TRIG:SLOP? POS The trigger output signal slope to positive.	

OUTPut[1|2]:TRIGger Source Specific Command

Description	Sets or queries the trigger output signal on or off. By default the signal is disabled. When enabled, a TTL compatible square wave is output.	
Syntax	OUTPut[1 2]:TRIGger {OFF ON}	
Parameter	OFF	Turns the output off.
	ON	Turns the output on.
Example	OUTP1:TRIG ON Turns the output on.	
Query Syntax	OUTPut[1 2]:TRIGger?	
Return Parameter	0	Disabled
	1	Enabled
Query Example	OUTP1:TRIG? 1	

The trigger output is enabled.

Arbitrary Waveform Commands

Arbitrary Waveform Overview

Use the steps below to output an arbitrary waveform over the remote interface.

- | | |
|---|---|
| Output Arbitrary Waveform | 1. Use the SOURce[1 2]:FUNCtion USER command to output the arbitrary waveform currently selected in memory. |
| ↓ | |
| Select Waveform Frequency, amplitude and offset | 2. Use the APPLy command to select frequency, amplitude and DC offset. Alternatively, the FUNC, FREQ, AMPL, and DCOffs commands can be used. |
| ↓ | |
| Load Waveform Data | 3. Waveform data (1 to 4096 points per waveform) can be downloaded into volatile memory using the DATA:DAC command. Binary integer or decimal integer values in the range of ± 511 can be used. |
| ↓ | |
| Set Waveform Rate | 4. The waveform rate is the product of the number of points in the waveform and the waveform frequency. |

$$\text{Rate} = \text{Hz} \times \# \text{ points}$$

Range:	Rate: 120MHz
	Frequency: 60MHz
	# points: 1~4096

SOURce[1|2]:FUNCTion USER Source Specific Command

Description Use the SOURce[1 |2]:FUNCTion USER command to output the arbitrary waveform currently selected in memory. The waveform is output with the current frequency, amplitude and offset settings.

Syntax **SOURce[1|2]:FUNCTion USER**

Example **SOUR1:FUNC USER**
 Selects and outputs the current waveform in memory.

DATA:DAC Source Specific Command

Description The DATA:DAC command is used to download binary or decimal integer values into memory using the IEEE-488.2 binary block format or as an ordered list of values.

Note The integer values (± 511) correspond to the maximum and minimum peak amplitudes of the waveform. For instance, for a waveform with an amplitude of 5Vpp (0 offset), the value 511 is the equivalent of 2.5 Volts. If the integer values do not span the full output range, the peak amplitude will be limited.

The IEEE-488.2 binary block format is comprised of three parts:

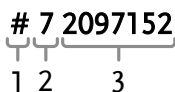

1. Initialization character (#)
2. Digit length (in ASCII) of the number of bytes
3. Number of bytes

IEEE 488.2 uses two bytes to represent waveform

	data (16 bit integer). Therefore the number of bytes is always twice the number of data points.	
Syntax	DATA:DAC VOLATILE, <start>, {<binary block> <value>, <value>, ... }	
Parameter	<start>	Start address of the arbitrary waveform
	<binary block>	
	<value>	Decimal or integer values ±511
Example	DATA:DAC VOLATILE, #216 Binary Data The command above downloads 5 data values (stored in 16 bytes) using the binary block format. DATA:DAC VOLATILE, 1000, 511, 200, 0, -200, -511 Downloads the data values (511, 200, 0, -200, -511) to address 1000.	

	SOURce[1 2]:ARB:EDIT:COPY	Source Specific Command
Description	Copies a segment of a waveform to a specific starting address.	
Syntax	SOURce[1 2]:ARB:EDIT:COPY [<start>[,<length>[,<paste>]]]	
Parameter	<start>	Start address: 0~4095
	<length>	1 ~ 4096
	<paste>	Paste address: 0~4095
Example	SOUR1:ARB:EDIT:COPY 1000, 256, 1257 Copies 256 data values starting at address 1000 and copies them to address 1257.	

SOURce[1 2]:ARB:EDIT:DELeTe		Source Specific Command
Description	Deletes a segment of a waveform from memory. The segment is defined by a starting address and length.	
Note	A waveform/ waveform segment cannot be deleted when output.	
Syntax	SOURce[1 2]:ARB:EDIT:DELeTe [<START>[,<LENGTh>]]	
Parameter	<START>	Start address: 0~4095
	<LENGTh>	1 ~ 4096
Example	SOURce1:ARB:EDIT:DEL 1000, 256 Deletes a section of 256 data points from the waveform starting at address 1000.	

SOURce[1 2]:ARB:EDIT:DELeTe:ALL		Source Specific Command
Description	Deletes all user-defined waveforms from non-volatile memory and the current waveform in volatile memory.	
Note	A waveform cannot be deleted when output.	
Syntax	SOURce[1 2]:ARB:EDIT:DELeTe:ALL	
Example	SOUR1:ARB:EDIT:DEL:ALL Deletes all user waveforms from memory.	

SOURce[1 2]:ARB:EDIT:POINt		Source Specific Command
Description	Edit a point on the arbitrary waveform.	
Note	A waveform/ waveform segment cannot be deleted when output.	
Syntax	SOURce[1 2]:ARB:EDIT:POINt [<address> [, <data>]]	
Parameter	<address>	Address of data point: 0~4095

	<code><data></code>	Value data: ± 511
--	---------------------------	-----------------------

Example **SOUR1:ARB:EDIT:POIN 1000, 511**

Creates a point on the arbitrary waveform at address 1000 with the highest amplitude.

SOURce[1|2]:ARB:EDIT:LINE Source Specific Command

Description Edit a line on the arbitrary waveform. The line is created with a starting address and data point and a finishing address and data point.

Note A waveform/waveform segment cannot be deleted when output.

Syntax **SOURce[1|2]:ARB:EDIT:LINE**
[<address1>[,<data>[,<address2>[,<data2>]]]]

Parameter	<code><address1></code>	Address of data point1: 0~4095
	<code><data1></code>	Value data2: ± 511
	<code><address2></code>	Address of data point2: 0~4095
	<code><data2></code>	Value data2: ± 511

Example **SOUR1:ARB:EDIT:LINE 40, 50, 100, 50**

Creates a line on the arbitrary waveform at 40,50 to 100,50.

SOURce[1|2]:ARB:EDIT:PROTect Source Specific Command

Description Protects a segment of the arbitrary waveform from deletion or editing.

Syntax **SOURce[1|2]:ARB:EDIT:PROTect**
[<START>[,<LENGth>]

Parameter	<code><START></code>	Start address: 0~4095
	<code><LENGth></code>	1 ~ 4096

Example **SOUR1:ARB:EDIT:PROT 40, 50**

Protects a segment of the waveform from address 40 for 50 data points.

SOURce[1|2]:ARB:EDIT:PROTECT:ALL Source Specific Command

Description Protects the arbitrary waveform currently in non-volatile memory/ currently being output.

Syntax **SOURce[1|2]:ARB:EDIT:PROTECT:ALL**

Example **SOUR1:ARB:EDIT:PROT:ALL**

SOURce[1|2]:ARB:EDIT:UNProtect Source Specific Command

Description Uprotects the arbitrary waveform currently in non-volatile memory/ currently being output.

Syntax **SOURce[1|2]:ARB:EDIT:UNProtect**

Example **SOUR1:ARB:EDIT:UNP**

SOURce[1|2]:ARB:OUTPut Source Specific Command

Description Output the current arbitrary waveform in volatile memory. A specified start and length can also be designated.

Syntax **SOURce[1|2]:ARB:OUTPut [<START>[,<LENGTH>]]**

Parameter <START> Start address*: 0~4096

<LENGTH> Length*: 0 ~ 4096

* Start + Length ≤ currently output arbitrary waveform

Example **SOUR1:ARB:OUTP 20 200**

Outputs the current arbitrary waveform in memory.

COUNTER

The frequency counter function can be turned on remotely to control the frequency counter.

COUNTER:STATE	Instrument Command
----------------------	-----------------------

Description	Turns the frequency counter function on or off.
Syntax	COUNter:STATe {ON OFF}
Example	COUNter:STATe ON Turns the frequency counter on
Query Syntax	COUNter:STATe?
Return Parameter	1 ON 0 OFF
Example	COUNter:STATe? 1 Turns on the frequency counter.

COUNter:GATe	Instrument Command
---------------------	-----------------------

Description	Sets the gate time for the frequency counter.
Syntax	COUNter:GATe {0.01 0.1 1 10}
Example	COUNter:GATe 1 Sets the gate time to 1S.
Syntax	COUNter:GATe? {max min}
Example	COUNter:GATe? 1 Returns the gate time: 1S.

COUNter:VALue? Instrument
Command

Description Returns the current value from the frequency counter.

Syntax COUNter:VALue?

Example **COUNter:VALue?**
+5.00E+02
Returns the frequency as 500Hz.

PHASE

The phase command remotely controls the phase and channel synchronization.

SOURce[1|2]:PHASe Instrument
Command

Description Sets the phase.

Syntax **SOURce[1|2]:PHASe** {<phase>|<MIN>|<MAX>}

Parameter	phase	-180~180
	min	Sets the phase to the minimum value.
	max	Sets the phase to the maximum value.

Example **SOURce1:PHASe 25**
Sets the phase of channel 1 to 25°.

Query Syntax **SOURce[1|2]:PHASe? {MAX|MIN}**

Return Parameter phase Returns the current phase.

Example **SOURce1:PHASe?**
26
Returns the phase of channel 1 as 26°.

SOURce[1|2]:PHASe:SYNChronize Instrument
Command

Description	Synchronizes the phase of channel 1 and channel 2. SOURce1 or SOURce2 has not effect on this command.
Syntax	SOURce[1 2]:PHASe:SYNChronize
Example	SOURce1:PHASe:SYNChronize Synchronizes the phase of channel 1 and channel 2.

COUPLE

The Couple commands can be used to remotely set the frequency coupling and amplitude coupling.

SOURce[1|2]:FREQUency:COUPlE:MODE Instrument
Command

Description	Set the frequency coupling mode.
Syntax	SOURce[1 2]:FREQUency:COUPlE:MODE {Off Offset Ratio}
Example	SOURce1:FREQUency:COUPlE:MODE Offset Sets the frequency coupling mode to offset.
Query Syntax	SOURce[1 2]:FREQUency:COUPlE:MODE ?
Return Parameter	Off Disables frequency coupling. Offset Set frequency coupling to offset mode. Ratio Sets frequency coupling to ratio mode.
Example	SOURce1:FREQUency:COUPlE:MODE ? Off Frequency coupling is turned off.

SOURce[1|2]:FREQUency:COUPle:OFFSet Instrument Command

Description Sets the offset frequency when the frequency coupling mode is set to offset.

Syntax **SOURce[1|2]:FREQUency:COUPle:OFFSet {frequency}**

Example **SOURce1:FREQUency:COUPle:OFFSet 2khz**

Sets the offset frequency to 2kHz (the frequency of CH2 minus CH1 is 2kHz).

Syntax **SOURce[1|2]:FREQUency:COUPle:OFFSet?**

Example **SOURce1:FREQUency:COUPle:OFFSet?**

+2.0000E+03

The offset of channel 2 from channel 1 is 2kHz.

SOURce[1|2]:FREQUency:COUPle:RATio Instrument Command

Description Sets the frequency coupling ratio when frequency coupling is set to ratio mode.

Syntax **SOURce[1|2]:FREQUency:COUPle:RATio {ratio}**

Example **SOURce1:FREQUency:COUPle:RATio 2**

Set the CH2 to CH1 frequency ratio to 2.

Query Syntax **SOURce[1|2]:FREQUency:COUPle:RATio?**

Example **SOURce1:FREQUency:COUPle:RATio?**

+2.0000E+00

Returns the CH2 to CH1 frequency ratio as 2.

SOURce[1|2]:AMPLitude:COUPle:STATe Instrument Command

Description Enables or disables the amplitude coupling.

Syntax **SOURce[1|2]:AMPLitude:COUPle:STATe {ON | Off}**

Example	SOURce1:AMPLitude:COUPlE:STATe on
Description	Turns amplitude coupling on.
Query Syntax	SOURce[1 2]:AMPLitude:COUPlE:STATe?
Return Parameter	1 ON 0 Off
Example	SOURce1:AMPLitude:COUPlE:STATe? 1 Amplitude coupling has been enabled.

	Instrument Command
SOURce[1 2]:TRACk	
Description	Turns tracking on or off.
Syntax	SOURce[1 2]:TRACk {ON OFF INVerted}
Example	SOURce1:TRACk ON Turns tracking on. Channel 2 will “track” the changes of channel 1.
Query Syntax	SOURce[1 2]:TRACk?
Return Parameter	ON ON OFF OFF INV INVerted
Example	SOURce1:TRACk? ON Channel tracking is turned on.

Save and Recall Commands

Up to 10 different instrument states can be stored to non-volatile memory (memory locations 0~9).

*SAV		Instrument Command
Description	Saves the current instrument state to a specified save slot. When a state is saved, all the current instrument settings, functions and waveforms are also saved.	
Note	The *SAV command doesn't save waveforms in non-volatile memory, only the instrument state. The *RST command will not delete saved instrument states from memory.	
Syntax	*SAV {0 1 2 3 4 5 6 7 8 9}	
Example	*SAV 0 Save the instrument state to memory location 0.	
*RCL		Instrument Command
Description	Recall previously saved instrument states from memory locations 0~9.	
Syntax	*RCL {0 1 2 3 4 5 6 7 8 9}	
Example	*RCL 0 Recall instrument state from memory location 0.	
MEMory:STATe:DELeTe		Instrument Command
Description	Delete memory from a specified memory location.	
Syntax	MEMory:STATe:DELeTe {0 1 2 3 4 5 6 7 8 9}	
Example	MEM:STAT:DEL 0	

Delete instrument state from memory location 0.

	Instrument Command
MEMory:STATe:DELeTe ALL	
Description	Delete memory from all memory locations, 0~9.
Syntax	MEMory:STATe:DELeTe ALL
Example	MEM:STAT:DEL ALL Deletes all the instrument states from memory locations 0~9.

Error Messages

The AFG-2225 has a number of specific error codes. Use the SYSTem:ERRor command to recall the error codes. For more information regarding the error queue.

Command Error Codes

-101 Invalid character

An invalid character was used in the command string. Example: #, \$, %.

```
SOURce1:AM:DEPTH MIN%
```

-102 Syntax error

Invalid syntax was used in the command string. Example: An unexpected character may have been encountered, like an unexpected space.

```
SOURce1:APPL:SQUare , 1
```

-103 Invalid separator

An invalid separator was used in the command string. Example: a space, comma or colon was incorrectly used.

```
APPL:SIN 1 1000 OR SOURce1:APPL:SQUare
```

-108 Parameter not allowed

The command received more parameters than were expected. Example: An extra (not needed) parameter was added to a command

```
SOURce1:APPL? 10
```

-109 Missing parameter

The command received less parameters than expected. Example: A required parameter was omitted.

```
SOURce1:APPL:SQUare
```

-112 Program mnemonic too long

A command header contains more than 12 characters:

```
OUTP:SYNCHRONIZATION ON
```

-113 Undefined header

An undefined header was encountered. The header is syntactically correct. Example: the header contains a character mistake.

```
SOUR1:AMM:DEPT MIN
```

-123 Exponent too large

Numeric exponent exceeds 32,000. Example:

```
SOURce[1 | 2]:BURSt:NCYCles 1E34000
```

-124 Too many digits

The mantissa (excluding leading 0's) contains more than 255 digits.

-128 Numeric data not allowed

An unexpected numeric character was received in the command. Example: a numeric parameter is used instead of a character string.

```
SOURce1:BURSt:MODE 123
```

-131 Invalid suffix

An invalid suffix was used. Example: An unknown or incorrect suffix may have been used with a parameter.

```
SOURce1:SWEep:TIME 0.5 SECS
```

-138 Suffix not allowed

A suffix was used where none were expected. Example: Using a suffix when not allowed.

```
SOURce1:BURSt: NCYCles 12 CYC
```

-148 Character data not allowed

A parameter was used in the command where not allowed. Example: A discrete parameter was used where a numeric parameter was expected.

```
SOUR1:MARK:FREQ ON
```

-158 String data not allowed

An unexpected character string was used where none were expected. Example: A character string is used instead of a valid parameter.

SOURce1:SWEep:SPACing 'TEN'

-161 Invalid block data

Invalid block data was received. Example: The number of bytes sent with the DATA:DAC command doesn't correlate to the number of bytes specified in the block header.

-168 Block data not allowed

Block data was received where block data is not allowed. Example:

SOURce1:BURSt: NCYCles #10

-170~178 expression errors

Example: The mathematical expression used was not valid.

Execution Errors

-211 Trigger ignored

A trigger was received but ignored. Example: Triggers will be ignored until the function that can use a trigger is enabled (burst, sweep, etc.).

-223 Too much data

Data was received that contained too much data. Example: An arbitrary waveform with over 4096 points cannot be used.

-221 Settings conflict; turned off infinite burst to allow immediate trigger source

Example: Infinite burst is disabled when an immediate trigger source is selected. Burst count set to 65535 cycles.

-221 Settings conflict; infinite burst changed trigger source to MANUAL

Example: The trigger source is changed to immediate from manual when infinite burst mode is selected.

-221 Settings conflict; burst period increased to fit entire burst

Example: The function generator automatically increases the burst period to allow for the burst count or frequency.

-221 Settings conflict; burst count reduced

Example: The burst count is reduced to allow for the waveform frequency if the burst period is at it's maximum.

-221 Settings conflict; trigger delay reduced to fit entire burst

Example: The trigger delay is reduced to allow the current period and burst count.

-221 Settings conflict; triggered burst not available for noise

Example: Triggered burst cannot be used with noise.

-221 Settings conflict; amplitude units changed to Vpp due to high-Z load

Example: If a high impedance load is used, dBm units cannot be used. The units are automatically set to Vpp.

-221 Settings conflict; trigger output disabled by trigger external

Example: The trigger output terminal is disabled when an external trigger source is selected.

-221 Settings conflict; trigger output connector used by FSK

Example: The trigger output terminal cannot be used in FSK mode.

-221 Settings conflict; trigger output connector used by burst gate

Example: The trigger output terminal cannot be used in gated burst mode.

-221 Settings conflict;trigger output connector used by trigger external

Example: The trigger output connector is disabled when the trigger source is set to external.

-221 Settings conflict;frequency reduced for pulse function

Example: When the function is changed to pulse, the output frequency is automatically reduced if over range.

-221 Settings conflict;frequency reduced for ramp function

Example: When the function is changed to ramp, the output frequency is automatically reduced if over range.

-221 Settings conflict;frequency made compatible with burst mode

Example: When the function is changed to burst, the output frequency is automatically adjusted if over range.

-221 Settings conflict;frequency made compatible with FM

Example: When the function is changed to FM, the frequency is automatically adjusted to suit the FM settings.

-221 Settings conflict;burst turned off by selection of other mode or modulation

Example: Burst mode is disabled when sweep or a modulation mode is enabled.

-221 Settings conflict;FSK turned off by selection of other mode or modulation

Example: FSK mode is disabled when burst, sweep or a modulation mode is enabled.

-221 Settings conflict;FM turned off by selection of other mode or modulation

Example: FM mode is disabled when burst, sweep or a modulation mode is enabled.

-221 Settings conflict;AM turned off by selection of other mode or modulation

Example: AM mode is disabled when burst, sweep or a modulation mode is enabled.

-221 Settings conflict; sweep turned off by selection of other mode or modulation

Example: Sweep mode is disabled when burst or a modulation mode is enabled.

-221 Settings conflict;not able to modulate this function

Example: A modulated waveform cannot be generated with dc voltage, noise or pulse waveforms.

-221 Settings conflict;not able to sweep this function

Example: A swept waveform cannot be generated with dc voltage, noise or pulse waveforms.

-221 Settings conflict;not able to burst this function

Example: A burst waveform cannot be generated with the dc voltage function.

-221 Settings conflict;not able to modulate noise, modulation turned off

Example: A waveform cannot be modulated using the noise function.

-221 Settings conflict;not able to sweep pulse, sweep turned off

Example: A waveform cannot be swept using the pulse function.

-221 Settings conflict;not able to modulate dc, modulation turned off

Example: A waveform cannot be modulated using the dc voltage function.

-221 Settings conflict;not able to sweep dc, modulation turned off

Example: A waveform cannot be swept using the dc voltage function.

-221 Settings conflict;not able to burst dc, burst turned off

Example: The burst function cannot be used with the dc voltage function.

-221 Settings conflict;not able to sweep noise, sweep turned off

Example: A waveform cannot be swept using the noise function.

-221 Settings conflict;pulse width decreased due to period

Example: The pulse width has been adjusted to suit the period settings.

-221 Settings conflict;amplitude changed due to function

Example: The amplitude (VRM / dBm) has been adjusted to suit the selected function. For the AFG-2225, a typical square wave has a much higher amplitude (5V Vrms) compared to a sine wave (~3.54) due to crest factor.

-221 Settings conflict;offset changed on exit from dc function

Example: The offset level is adjusted on exit from a DC function.

-221 Settings conflict;FM deviation cannot exceed carrier

Example: The deviation cannot be set higher than the carrier frequency

-221 Settings conflict;FM deviation exceeds max frequency

Example: If the FM deviation and carrier frequency combined exceeds the maximum frequency plus 100 kHz, the deviation is automatically adjusted.

-221 Settings conflict;frequency forced duty cycle change

Example: If the frequency is changed and the current duty cannot be supported at the new frequency, the duty will be automatically adjusted.

-221 Settings conflict;offset changed due to amplitude

Example: The offset is not a valid offset value, it is automatically adjusted, considering the amplitude.

$$|\text{offset}| \leq \text{max amplitude} - V_{pp}/2$$

-221 Settings conflict;amplitude changed due to offset

Example: The amplitude is not a valid value, it is automatically adjusted, considering the offset.

$$V_{pp} \leq 2X (\text{max amplitude} - |\text{offset}|)$$

-221 Settings conflict;low level changed due to high level

Example: The low level value was set too high. The low level is set 1 mV less than the high level.

-221 Settings conflict;high level changed due to low level

Example: The high level value was set too low. The high level is set 1 mV greater than the low level.

-222 Data out of range;value clipped to upper limit

Example: The parameter was set out of range. The parameter is automatically set to the maximum value allowed.

SOURce[1 | 2]:FREQuency 25.1MHz.

-222 Data out of range;value clipped to lower limit

Example: The parameter was set out of range. The parameter is automatically set to the minimum value allowed.

SOURce[1 | 2]:FREQuency 0.1μHz.

-222 Data out of range;period; value clipped to ...

Example: If the period was set to a value out of range, it is automatically set to an upper or lower limit.

-222 Data out of range;frequency; value clipped to ...

Example: If the frequency was set to a value out of range, it is automatically set to an upper or lower limit.

-222 Data out of range;user frequency; value clipped to upper limit

Example: If the frequency is set to a value out of range for an arbitrary waveform using, SOURCE[1 | 2]: APPL: USER or SOURCE[1 | 2]: FUNC:USER, it is automatically set to the upper limit.

-222 Data out of range;ramp frequency; value clipped to upper limit

Example: If the frequency is set to a value out of range for a ramp waveform using, SOURCE[1 | 2]: APPL: RAMP or SOURCE[1 | 2]: FUNC:RAMP, it is automatically set to the upper limit.

-222 Data out of range;pulse frequency; value clipped to upper limit

Example: If the frequency is set to a value out of range for a pulse waveform using, SOURCE[1 | 2]: APPL:PULS or SOURCE[1 | 2]: FUNC:PULS, it is automatically set to the upper limit.

-222 Data out of range;burst period; value clipped to ...

Example: If the burst period was set to a value out of range, it is automatically set to an upper or lower limit.

222 Data out of range;burst count; value clipped to ...

Example: If the burst count was set to a value out of range, it is automatically set to an upper or lower limit.

-222 Data out of range; burst period limited by length of burst; value clipped to upper limit

Example: The burst period must be greater than burst count divided by the frequency + 200 ns. The burst period is adjusted to satisfy these conditions.

$\text{burst period} > 200 \text{ ns} + (\text{burst count} / \text{burst frequency})$.

-222 Data out of range; burst count limited by length of burst; value clipped to lower limit

Example: The burst count must be less than burst period * the waveform frequency when the trigger source is set to immediate (SOURce[1 | 2]: TRIG:SOUR IMM). The burst count is automatically set to the lower limit.

-222 Data out of range; amplitude; value clipped to ...

Example: If the amplitude was set to a value out of range, it is automatically set to an upper or lower limit.

-222 Data out of range; offset; value clipped to ...

Example: If the offset was set to a value out of range, it is automatically set to an upper or lower limit.

-222 Data out of range; frequency in burst mode; value clipped to ...

Example: If the frequency was set to a value out of range in burst mode. The burst frequency is automatically set to an upper or lower limit, taking the burst period into account.

-222 Data out of range; frequency in FM; value clipped to ...

Example: The carrier frequency is limited by the frequency deviation (SOURce[1 | 2]: FM:DEV). The carrier frequency is automatically adjusted to be less than or equal to the frequency deviation.

-222 Data out of range;marker confined to sweep span; value clipped to ...

Example: The marker frequency is set to a value outside the start or stop frequencies. The marker frequency is automatically adjusted to either the start or stop frequency (whichever is closer to the set value).

-222 Data out of range;FM deviation; value clipped to ...

Example: The frequency deviation is outside of range. The deviation is automatically adjusted to an upper or lower limit, depending on the frequency.

-222 Data out of range;trigger delay; value clipped to upper limit

Example: The trigger delay was set to a value out of range. The trigger delay has been adjusted to the maximum (655350 nseconds).

-222 Data out of range; trigger delay limited by length of burst; value clipped to upper limit

Example: The trigger delay and the burst cycle time combined must be less than the burst period.

-222 Data out of range;duty cycle; value clipped to ...

Example: The duty cycle is limited depending on the frequency.

Duty Cycle	Frequency
50%	> 25MHz
10%~90%	100 KHz ~ 1MHz
1%~99%	< 100KHz

-222 Data out of range; duty cycle limited by frequency; value clipped to upper limit

Example: The duty cycle is limited depending on the frequency. When the frequency is greater than 50 MHz, the duty cycle is automatically limited to 50%.

-313 Calibration memory lost;memory corruption detected

Indicates that a fault (check sum error) has occurred with the non-volatile memory that stores the calibration data.

-314 Save/recall memory lost;memory corruption detected

Indicates that a fault (check sum error) has occurred with the non-volatile memory that stores the save/recall files.

-315 Configuration memory lost;memory corruption detected

Indicates that a fault (check sum error) has occurred with the non-volatile memory that stores the configuration settings.

-350 Queue overflow

Indicates that the error queue is full (over 20 messages generated, and not yet read). No more messages will be stored until the queue is empty. The queue can be cleared by reading each message, using the *CLS command or restarting the function generator.

Query Errors

-410 Query INTERRUPTED

Indicates that a command was received but the data in the output buffer from a previous command was lost.

-420 Query UNTERMINATED

The function generator is ready to return data, however there was no data in the output buffer. For example: Using the APPLY command.

-430 Query DEADLOCKED

Indicates that a command generates more data than the output buffer can receive and the input buffer is full. The command will finish execution, though all the data won't be kept.

Arbitrary Waveform Errors

-770 Nonvolatile arb waveform memory corruption detected

Indicates that a fault (check sum error) has occurred with the non-volatile memory that stores the arbitrary waveform data.

-781 Not enough memory to store new arb waveform; bad sectors

Indicates that a fault (bad sectors) has occurred with the non-volatile memory that stores the arbitrary waveform data. Resulting in not enough memory to store arbitrary data.

-787 Not able to delete the currently selected active arb waveform

Example: The currently selected waveform is being output and cannot be deleted.

800 Block length must be even

Example: As block data (DATA:DAC VOLATILE) uses two bytes to store each data point, there must be an even number of bytes for a data block.

SCPI Status Register

The status registers are used to record and determine the status of the function generator.

The function generator has a number of register groups:

Questionable Status Registers

Standard Event Status Registers

Status Byte Register

As well as the output and error queues.

Each register group is divided into three types of registers: condition registers, event registers and enable registers.

Register types

Condition Register	The condition registers indicate the state of the function generator in real time. The condition registers are not triggered. I.e., the bits in the condition register change in real time with the instrument status. Reading a condition register will not clear it. The condition registers cannot be cleared or set.
Event Register	The Event Registers indicate if an event has been triggered in the condition registers. The event registers are latched and will remain set unless the *CLS command is used. Reading an event register will not clear it.
Enable Register	The Enable register determines which status event(s) are enabled. Any status events that are not enabled are ignored. Enabled events are used to summarize the status of that register group.

AFG-2225 Status System

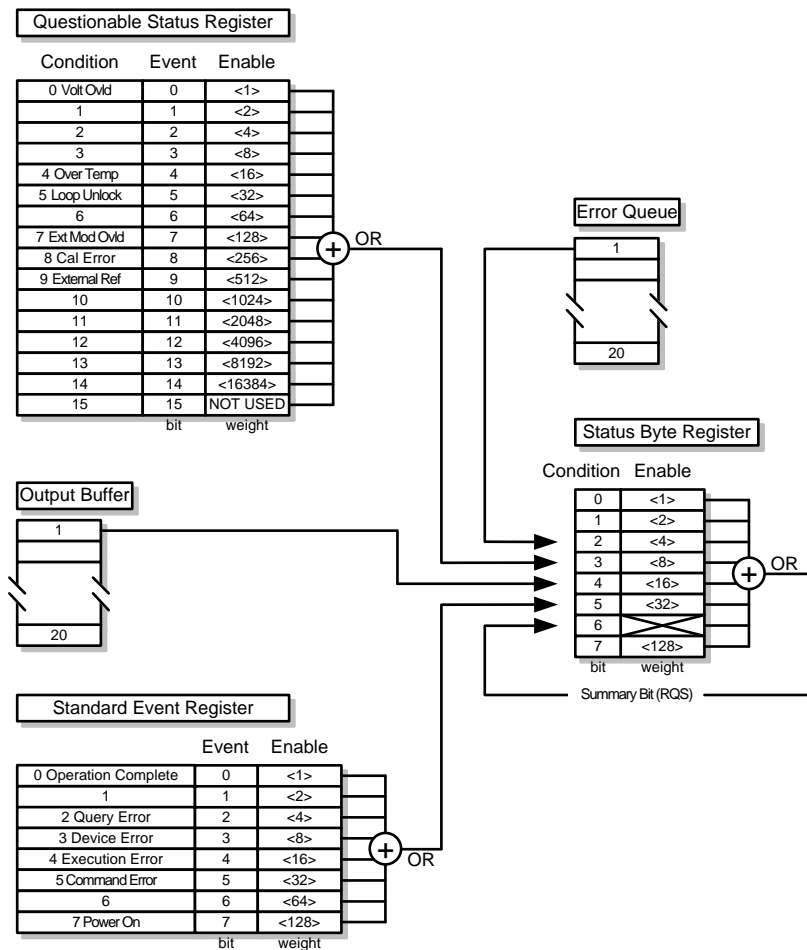

Questionable Status Register

Description	The Questionable Status Registers will show if any faults or errors have occurred.		
Bit Summary	Register	Bit	Bit Weight
	Voltage overload	0	1
	Over temperature	4	16
	Loop unlock	5	32
	Ext Mod Overload	7	128
	Cal Error	8	256
	External Reference	9	512

Standard Event Status Registers

Description	The Standard Event Status Registers indicate when the *OPC command has been executed or whether any programming errors have occurred.
Notes	<p>The Standard Event Status Enable register is cleared when the *ESE 0 command is used.</p> <p>The Standard Event Status Event register is cleared when the *CLS command or the *ESR? command is used.</p>

Bit Summary	Register	Bit	Bit Weight
	Operation complete bit	0	1
	Query Error	2	4
	Device Error	3	8
	Execution Error	4	16
	Command Error	5	32
	Power On	7	128

Error Bits	Operation complete	The operation complete bit is set when all selected pending operations are complete. This bit is set in response to the *OPC command.
	Query Error	The Query Error bit is set when there is an error reading the Output Queue. This can be caused by trying to read the Output Queue when there is no data present.
	Device Error	The Device Dependent Error indicates a failure of the self-test, calibration, memory or other device dependent error.
	Execution Error	The Execution bit indicates an execution error has occurred.
	Command Error	The Command Error bit is set when a syntax error has occurred.
	Power On	Power has been reset.

The Status Byte Register

Description The Status Byte register consolidates the status events of all the status registers. The Status Byte register can be read with the *STB? query or a serial poll and can be cleared with the *CLS command.

Clearing the events in any of the status registers will clear the corresponding bit in the Status Byte register.

Notes The Status byte enable register is cleared when the *SRE 0 command is used.

The Status Byte Condition register is cleared when the *CLS command is used.

Bit Summary	Register	Bit	Bit Weight
	Error Queue	2	4
	Questionable Data	3	8
	Message Available	4	16
	Standard Event	5	32
	Master Summary / Request Service	6	64

Status Bits	Error Queue	There are error message(s) waiting in the error queue.
	Questionable data	The Questionable bit is set when an “enabled” questionable event has occurred.
	Message Available	The Message Available bit is set when there is outstanding data in the Output Queue. Reading all messages in the output queue will clear the message available bit.

Standard Event The Event Status bit is set if an “enabled” event in the Standard Event Status Event Register has occurred.

Master Summary/Service Request bit The Master Summary Status is used with the *STB? query. When the *STB? query is read the MSS bit is not cleared.

The Request Service bit is cleared when it is polled during a serial poll.

Output Queue

Description The Output queue stores output messages in a FIFO buffer until read. If the Output Queue has data, the MAV bit in the Status Byte Register is set.

Error Queue

Description The error queue is queried using the SYSTem:ERRor? command. The Error queue will set the “Error Queue” bit in the status byte register if there are any error messages in the error queue. If the error queue is full the last message will generate a “Queue overflow” error and additional errors will not be stored. If the error queue is empty, “No error” will be returned.

Error messages are stored in the error queue in a first-in-first-out order. The errors messages are character strings that can contain up to 255 characters.

APPDENIX

AFG-2225 Specifications

The specifications apply when the function generator is powered on for at least 30 minutes under +18°C~+28°C.

AFG-2225 models		CH1	CH2
Waveforms		Sine, Square, Ramp, Pulse, Noise, ARB	
Arbitrary Functions			
	Sample Rate	120 MSa/s	
	Repetition Rate	60MHz	
	Waveform Length	4k points	
	Amplitude	10 bits	
	Resolution		
	Non-Volatile	4k points	
	Memory		
Frequency Characteristics			
Range	Sine	1uHz~25MHz	
	Square	1uHz~25MHz	
	Ramp	1MHz	
Resolution		1uHz	
Accuracy	Stability	±20 ppm	
	Aging	±1 ppm, per 1 year	
	Tolerance	≤1 mHz	
Output Characteristics			
Amplitude	Range	1mVpp to 10 Vpp (into 50Ω)	
		2mVpp to 20 Vpp (open-circuit)	
	Accuracy	1mVpp to 5 Vpp (into 50Ω) for 20MHz-25MHz	
		2mVpp to 10 Vpp (open-circuit) for 20MHz-25MHz	
		±2% of setting ±1 mVpp (at 1 kHz)	
	Resolution	1mV or 3 digits	
	Flatness	±1% (0.1dB) ≤100kHz	
±3% (0.3 dB) ≤5MHz			
±5% (0.4 dB) ≤12MHz			
±10% (0.9dB) ≤25MHz (sine wave relative to 1kHz)			
Units	Vpp, Vrms, dBm		

Offset	Range	± 5 Vpk ac +dc (into 50 Ω) ± 10 Vpk ac +dc (Open circuit) ± 2.5 Vpk ac +dc (into 50 Ω) for 20MHz-25MHz ± 5 Vpk ac +dc (Open circuit) for 20MHz-25MHz	
	Accuracy	2% of setting + 10mV+ 0.5% of amplitude	
Waveform Output	Impedance	50 Ω typical (fixed) > 10M Ω (output disabled)	
	Protection	Short-circuit protected Overload relay automatically disables main output	
Sine wave Characteristics			
	Harmonic distortion	≤ -55 dBc DC ~ 200kHz, Ampl > 0.1Vpp ≤ -50 dBc 200kHz ~ 1MHz, Ampl > 0.1Vpp ≤ -35 dBc 1MHz ~ 5MHz, Ampl > 0.1Vpp ≤ -30 dBc 5MHz ~ 25MHz, Ampl > 0.1Vpp	
Square wave Characteristics			
	Rise/Fall Time	≤ 25 ns at maximum output. (into 50 Ω load)	
	Overshoot	5%	
	Asymmetry	1% of period +5 ns	
	Variable duty Cycle	1.0% to 99.0% ≤ 100 kHz 10% to 90% ≤ 1 MHz 50% ≤ 25 MHz	
Ramp Characteristics			
	Linearity	< 0.1% of peak output	
	Variable Symmetry	0% to 100% (0.1% Resolution)	
Pulse Characteristics			
	Period	40ns~2000s	
	Pulse Width	20ns~1999.9s	
	Overshoot	<5%	
	Jitter	20ppm +10ns	
AM Modulation			
	Carrier Waveforms	Sine, Square, Ramp, Pulse, Arb	Sine, Square, Ramp, Pulse, Arb
	Modulating Waveforms	Sine, Square, Triangle, Upramp, Dnramp	Sine, Square, Triangle, Upramp, Dnramp
	Modulating Frequency	2mHz to 20kHz (Int) DC to 20kHz (Ext)	2mHz to 20kHz (Int) DC to 20kHz (Ext)
	Depth	0% to 120.0%	
	Source	Internal / External	
FM Modulation			
	Carrier Waveforms	Sine, Square, Ramp, Upramp, Dnramp	Sine, Square, Ramp, Upramp, Dnramp
	Modulating Waveforms	Sine, Square, Triangle, Upramp, Dnramp	Sine, Square, Triangle, Upramp, Dnramp
	Modulating Frequency	2mHz to 20kHz (Int) DC to 20kHz (Ext)	2mHz to 20kHz (Int) DC to 20kHz (Ext)

	Peak Deviation Source	DC to Max Frequency Internal / External	DC to Max Frequency Internal / External
Sweep	Waveforms	Sine, Square, Ramp,	Sine, Square, Ramp,
	Type	Linear or Logarithmic	Linear or Logarithmic
	Start/Stop Freq	1uHz to Max Frequency	1uHz to Max Frequency
	Sweep Time	1ms to 500s	1ms to 500s
	Source	Internal / External/Manual	Internal / External/Manual
FSK	Carrier Waveforms	Sine, Square, Ramp,Pulse	Sine, Square, Ramp,Pulse
	Modulating Waveforms	50% duty cycle square	50% duty cycle square
	Modulation Rate	2mHz to 100 kHz (INT) DC to 100 kHz(EXT)	2mHz to 100 kHz (INT) DC to 100 kHz(EXT)
	Frequency Range	1uHz to Max Frequency	1uHz to Max Frequency
	Source	Internal / External	Internal / External
PM	Carrier Waveforms	Sine, Square, Ramp	Sine, Square, Ramp
	Modulating Waveforms	Sine, Square, Triangle, Upramp, Dnramp	Sine, Square, Triangle, Upramp, Dnramp
	Modulation Frequency	2mHz to 20kHz (Int) DC to 20kHz (Ext)	2mHz to 20kHz (Int) DC to 20kHz (Ext)
	Phase deviation	0° to 360°	0° to 360°
	Source	Internal / External	Internal / External
SUM	Carrier Waveforms	Sine, Square, Ramp,Pulse,Noise	Sine, Square, Ramp,Pulse,Noise
	Modulating Waveforms	Sine, Square, Triangle, Upramp,Dnramp	Sine, Square, Triangle, Upramp,Dnramp
	Modulation Frequency	2mHz to 20kHz (Int) DC to 20kHz (Ext)	2mHz to 20kHz (Int) DC to 20kHz (Ext)
	SUM Depth	0% to 100.0%	0% to 100.0%
	Source	Internal / External	Internal / External
External Trigger Input	Type	For FSK, Burst, Sweep	
	Input Level	TTL Compatibility	
	Slope	Rising or Falling(Selectable)	
	Pulse Width	>100ns	
	Input Impedance	10kΩ, DC coupled	
External Modulation Input	Type	For AM, FM, PM, SUM	
	Voltage Range	±5V full scale	

	Input Impedance	10kΩ	
	Frequency	DC to 20kHz	
Trigger Output	Type	For Burst, Sweep, Arb	
	Level	TTL Compatible into 50Ω	
	Pulse Width	>450ns	
	Maximum Rate	1MHz	
	Fan-out	≥4 TTL Load	
	Impedance	50Ω Typical	
Dual Channel Function	Phase	-180° ~180°	-180° ~ 180°
		Synchronize phase	Synchronize phase
	Track	CH2=CH1	CH1=CH2
	Coupling	Frequency(Ratio or Difference)	Frequency(Ratio or Difference)
		Amplitude & DC Offset	Amplitude & DC Offset
	Dsolkink	√	√
Burst	Waveforms	Sine, Square, Ramp	Sine, Square, Ramp
	Frequency	1uHz~25MHz	1uHz~25MHz
	Burst Count	1 to 65535 cycles or Infinite	1 to 65535 cycles or Infinite
	Start/Stop Phase	-360 to +360	-360 to +360
	Internal Period	1ms to 500s	1ms to 500s
	Gate Source	External Trigger	External Trigger
	Trigger Source	Single, External or Internal Rate	Single, External or Internal Rate
Trigger Delay	N-Cycle, Infinite	0s to 655350ns	0s to 655350ns
Frequency Counter	Range	5Hz to 150MHz	
	Accuracy	Time Base accuracy±1 count	
	Time Base	±20ppm (23°C ±5°C) after 30 minutes warm up	
	Resolution	The maximum resolution is: 100nHz for 1Hz, 0.1Hz for 100MHz.	
	Input Impedance	1kΩ/1pf	
	Sensitivity	35mVrms ~ 30Vms (5Hz to 150MHz)	
Save/Recall		10 Groups of Setting Memories	
Interface		USB (Host&Device)	
Display		TFT	
General Specifications	Power Source	AC100~240V, 50~60Hz	
	Power Consumption	25 W (Max)	
	Operating Environment	Temperature to satisfy the specification : 18 ~ 28 °C Operating temperature : 0 ~ 40 °C Relative Humidity: < 80%, 0 ~ 40 °C Installation category : CAT II	

Operating Altitude	2000 Meters
Storage Temperature	-10~70 °C, Humidity: ≤70%
Dimensions (WxHxD)	266(W) x 107(H) x 293(D) mm
Weight	Approx. 2.5kg
Accessories	GTL-101×2 Quick Start Guide x1 CD (user manual + software) ×1 Power cord×1

EC Declaration of Conformity

We

GOOD WILL INSTRUMENT CO., LTD.

No.7-1, Jhongsing Rd., Tucheng Dist., New Taipei City 236, Taiwan

GOOD WILL INSTRUMENT (SUZHOU) CO., LTD.

No. 69, Lushan Road, Suzhou New District Jiangsu, China

declares that the below mentioned product

AFG-2225

Are herewith confirmed to comply with the requirements set out in the Council Directive on the Approximation of the Law of Member States relating to Electromagnetic Compatibility (2004/108/EC) and Low Voltage Equipment Directive (2006/95/EC). For the evaluation regarding the Electromagnetic Compatibility and Low Voltage Equipment Directive, the following standards were applied:

© EMC

EN 61326-1:	Electrical equipment for measurement, control and laboratory use — EMC requirements (2006)	
EN 61326-2-1:		
Conducted and Radiated Emissions EN 55011: 2009+A1:2010 (Class A)	Electrostatic Discharge IEC 61000-4-2: 2008	
Current Harmonic EN 61000-3-2: 2006+A2:2009	Radiated Immunity IEC 61000-4-3: 2010	
Voltage Fluctuation EN 61000-3-3: 2008	Electrical Fast Transients IEC 61000-4-4: 2012	
-----	Surge Immunity IEC 61000-4-5: 2005	
-----	Conducted Susceptibility IEC 61000-4-6: 2008	
-----	Power Frequency Magnetic Field IEC 61000-4-8: 2009	
-----	Voltage Dips/ Interrupts IEC 61000-4-11: 2004	

© Safety

Low Voltage Equipment Directive 2006/95/EC
Safety Requirements EN 61010-1: 2010

INDEX

AM commands.....	218	Frequency counter	137
Amplitude counter	140	Frequency counter commands	266
Apply commands	200	Frequency coupling	138
ARB commands	260	Front panel diagram	13
ARB error messages	285	FSK commands.....	228
Arbitrary waveforms.....	147	Function keys	
display	150	key overview	13
edit.....	159	Fuse replacement	
output.....	169	safety instruction.....	8
protection.....	166	Ground	
save and load	171	symbol.....	6
Beeper.....	137	Help menu	25
Burst commands	249	lin sweep	113
Caution symbol.....	6	List of features.....	11
Channel Settings	143	log sweep	113
Channel tracking.....	141	Menu Tree.....	44
Cleaning the instrument	8	Modulation	64
Command error codes	273	AM.....	66
Command list.....	189	carrier frequency.....	68
Coupling commands	268	carrier shape.....	67
Declaration of conformity	298	depth	72
Default settings	52	frequency	70
Digital inputs		shape	69
how to use	23	source.....	73
Display		amplitude.....	105
diagram.....	18	Burst.....	118
Disposal		count	121
symbol.....	7	delay	128
Disposal instructions.....	9	frequency	120
DSO link.....	146	modes.....	119
EN61010		output	129
measurement category.....	7		
pollution degree.....	9		
Environment			
safety instructions.....	8		
Error messages	273		
FM commands.....	223		

period	123	stop	109
phase	125	time	114
trigger	126	trigger	116
carrier frequency	102	wave	103
carrier wave	101	Operation	54
FM	75	Amplitude	62
carrier frequency	77	Frequency	60
carrier shape	76	Noise Wave	59
deviation	81	Offset	63
frequency	79	Pulse width	57
shape	78	Ramp	58
source	82	select waveform	55
frequency	104	Sine	55
FSK	84	Square	56
carrier frequency	86	Operation keys	
carrier shape	85	key overview	13
hop frequency	87	Output commands	206
rate	88	Output phase	144
source	90	Phase commands	267
PM	91	Phase sync	145
carrier frequency	93	PM commands	232
carrier shape	93	Power on/off	
deviation	97	safety instruction	7
frequency	95	Power up	20
shape	94	Pulse configuration commands	
source	98	216
source	106	Query Errors	285
SUM	100	Quick reference	21
Sweep	108	ARB	37
marker	115	burst	35
mode	113	coupling	42
span	111	frequency counter	41
start	109	modulation	29
		selecting a waveform	27
		sweep	34
		utility	40
		Rear panel diagram	16
		Remote control	180
		interface configuration	181
		Remote interface	
		Error messages	273
		functionality check	182
		SCPI registers	287
		screen lock	182
		Syntax	184
		terminal connection	182

Save and recall	132	Specifications	293
Save and Recall commands	271	Status register commands	196
SCPI registers	287	SUM commands	236
Screen lock	182	Sweep commands	240
Secondary System Settings	131	System commands	193
System and Settings	136	UK power cord	10
Service operation		Updating Firmware	136
about disassembly	7	USB	
Set output impedance	143	remote control interface	181
Setting up the instrument	19	Warning symbol	6
software download	182		