

## COMPLEMENTARY SILICON PLASTIC POWER TRANSISTORS

... designed for use in general purpose power amplifier and switching applications.

### FEATURES:

\* Collector-Emitter Sustaining Voltage -

$V_{CE(sus)}$  = 40V(Min)- TIP31, TIP32  
 60V(Min)- TIP31A, TIP32A  
 80V(Min)- TIP31B, TIP32B  
 100V(Min)- TIP31C, TIP32C

\* Collector-Emitter Saturation Voltage-  $V_{CE(sat)} = 1.2V(Max) @ I_C = 3.0 A$

\* Current Gain-Bandwidth Product  $f_T = 3.0 MHz (Min) @ I_C = 500 mA$

NPN	PNP
TIP31	TIP32
TIP31A	TIP32A
TIP31B	TIP32B
TIP31C	TIP32C

3 AMPERE  
 COMPLEMENTARY SILICON  
 POWER TRANSISTORS  
 40 -100 VOLTS  
 40 WATTS

### MAXIMUM RATINGS

Characteristic	Symbol	TIP31 TIP32	TIP31A TIP32A	TIP31B TIP32B	TIP31C TIP32C	Unit
Collector-Emitter Voltage	$V_{CEO}$	40	60	80	100	V
Collector-Base Voltage	$V_{CBO}$	40	60	80	100	V
Emitter-Base Voltage	$V_{EBO}$	5.0				V
Collector Current - Continuous - Peak	$I_C$	3.0 5.0				A
Base Current	$I_B$	1.0				A
Total Power Dissipation @ $T_C = 25^\circ C$ Derate above $25^\circ C$	$P_D$	40 0.32				W W/ $^\circ C$
Operating and Storage Junction Temperature Range	$T_J, T_{STG}$	-65 to +150				$^\circ C$

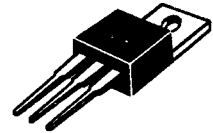

TO-220

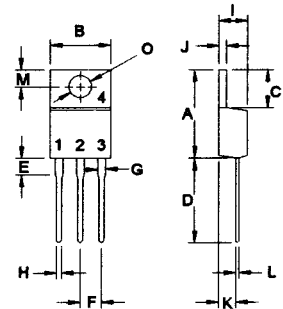

PIN 1. BASE  
 2. COLLECTOR  
 3. EMITTER  
 4. COLLECTOR(CASE)

### THERMAL CHARACTERISTICS

Characteristic	Symbol	Max	Unit
Thermal Resistance Junction to Case	$R_{\theta jc}$	3.125	$^\circ C/W$

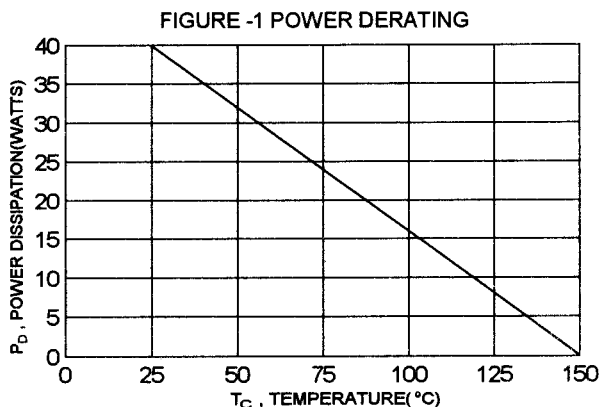

DIM	MILLIMETERS	
	MIN	MAX
A	14.68	15.31
B	9.78	10.42
C	5.01	6.52
D	13.06	14.62
E	3.57	4.07
F	2.42	3.66
G	1.12	1.36
H	0.72	0.96
I	4.22	4.98
J	1.14	1.38
K	2.20	2.97
L	0.33	0.55
M	2.48	2.98
O	3.70	3.90

**TIP31, TIP31A, TIP31B, TIP31C NPN / TIP32, TIP32A, TIP32B, TIP32C PNP**

**ELECTRICAL CHARACTERISTICS (  $T_c = 25^\circ\text{C}$  unless otherwise noted )**

Characteristic	Symbol	Min	Max	Unit
----------------	--------	-----	-----	------

**OFF CHARACTERISTICS**

Collector-Emitter Sustaining Voltage(1) ( $I_C = 30\text{ mA}$ , $I_B = 0$ )	TIP31, TIP32 TIP31A, TIP32A TIP31B, TIP32B TIP31C, TIP32C	$V_{CE(sus)}$	40 60 80 100	V
Collector Cutoff Current ( $V_{CE} = 30\text{ V}$ , $I_B = 0$ ) ( $V_{CE} = 60\text{ V}$ , $I_B = 0$ )	TIP31, TIP32, TIP31A, TIP32A TIP31B, TIP32B, TIP31C, TIP32C	$I_{CEO}$	0.3 0.3	mA
Collector Cutoff Current ( $V_{CE} = 40\text{ V}$ , $V_{EB} = 0$ ) ( $V_{CE} = 60\text{ V}$ , $V_{EB} = 0$ ) ( $V_{CE} = 80\text{ V}$ , $V_{EB} = 0$ ) ( $V_{CE} = 100\text{ V}$ , $V_{EB} = 0$ )	TIP31, TIP32 TIP31A, TIP32A TIP31B, TIP32B TIP31C, TIP32C	$I_{CES}$	0.2 0.2 0.2 0.2	mA
Emitter Cutoff Current ( $V_{EB} = 5.0\text{ V}$ , $I_C = 0$ )		$I_{EBO}$	1.0	mA

**ON CHARACTERISTICS (1)**

DC Current Gain ( $I_C = 1.0\text{ A}$ , $V_{CE} = 4.0\text{ V}$ ) ( $I_C = 3.0\text{ A}$ , $V_{CE} = 4.0\text{ V}$ )	$h_{FE}$	25 10	50	
Collector-Emitter Saturation Voltage ( $I_C = 3.0\text{ A}$ , $I_B = 375\text{ mA}$ )	$V_{CE(sat)}$		1.2	V
Base-Emitter On Voltage ( $I_C = 3.0\text{ A}$ , $V_{CE} = 4.0\text{ V}$ )	$V_{BE(on)}$		1.8	V

**DYNAMIC CHARACTERISTICS**

Current Gain - Bandwidth Product (2) ( $I_C = 500\text{ mA}$ , $V_{CE} = 10\text{ V}$ , $f_{TEST} = 1\text{ MHz}$ )	$f_T$	3.0		MHz
Small Signal Current Gain ( $I_C = 500\text{ mA}$ , $V_{CE} = 10\text{ V}$ , $f = 1\text{ kHz}$ )	$h_{fe}$	20		

(1) Pulse Test: Pulse width  $\leq 300\ \mu\text{s}$ , Duty Cycle  $\leq 2.0\%$

(2)  $f_T = |h_{fe}| \cdot f_{TEST}$

FIGURE 2 - SWITCHING TIME EQUIVALENT CIRCUIT

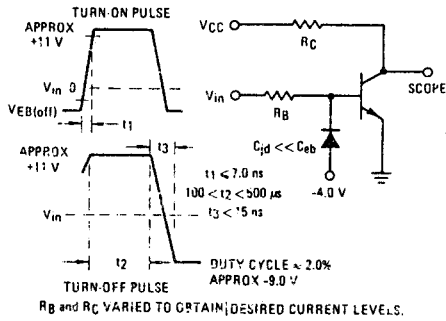

FIG-3 TURN-ON TIME

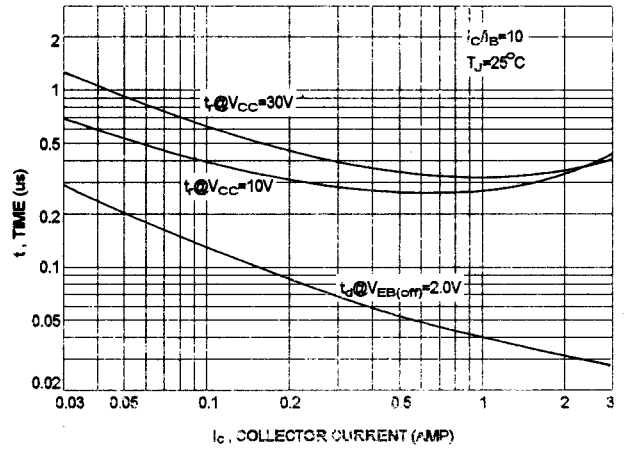

FIG-4 DC CURRENT GAIN

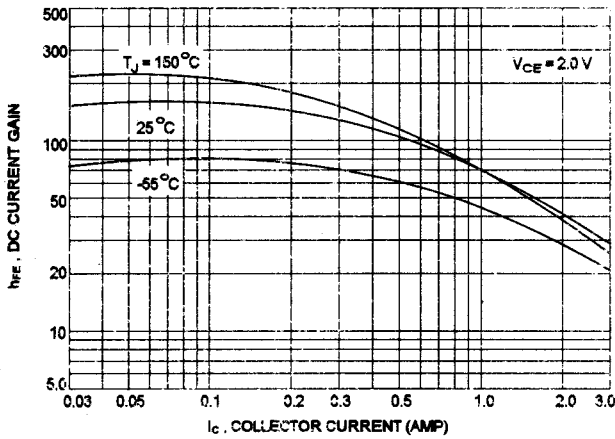

FIG-5 TURN-OFF TIME

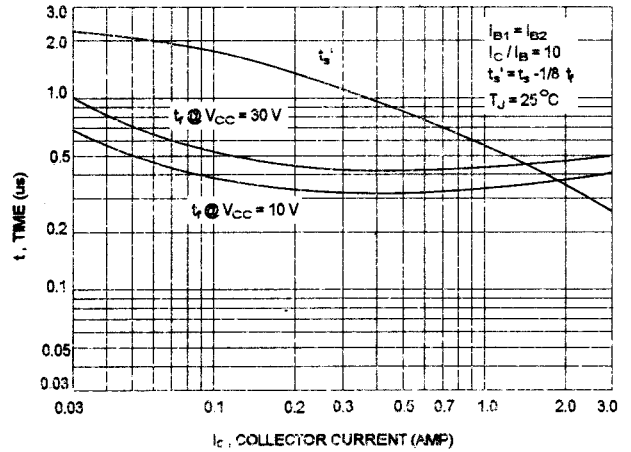
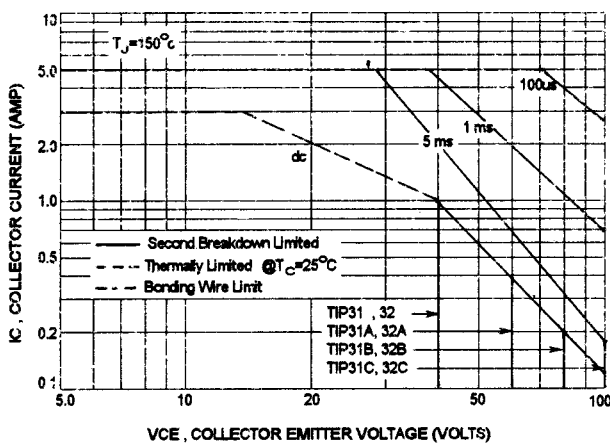

FIG-6 ACTIVE REGION SAFE OPERATING AREA



There are two limitation on the power handling ability of a transistor: average junction temperature and second breakdown safe operating area curves indicate  $I_C$ - $V_{CE}$  limits of the transistor that must be observed for reliable operation i.e., the transistor must not be subjected to greater dissipation than curves indicate.

The data of FIG-6 curve is base on  $T_{J(pk)} = 150^\circ C$ ;  $T_C$  is variable depending on power level. second breakdown pulse limits are valid for duty cycles to 10% provided  $T_{J(pk)} \leq 150^\circ C$ . At high case temperatures, thermal limitation will reduce the power that can be handled to values less than the limitations imposed by second breakdown.

TIP31, TIP31A, TIP31B, TIP31C NPN / TIP32, TIP32A, TIP32B, TIP32C PNP

FIG-7 COLLECTOR SATURATION REGION

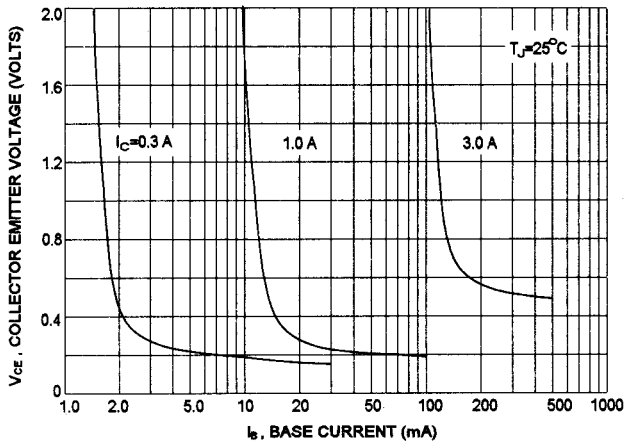

FIG-8 CAPACITANCES

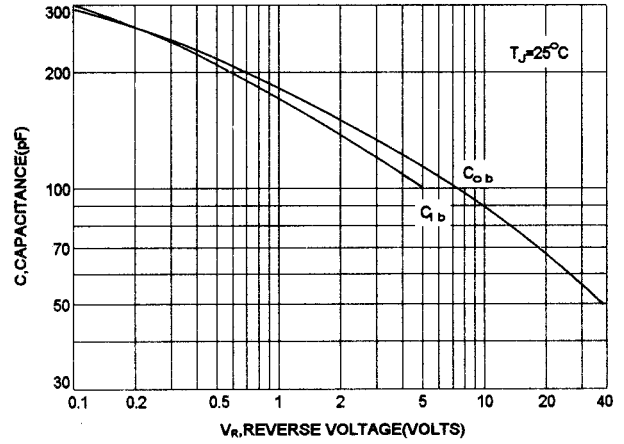

FIG-9 "ON" VOLTAGE

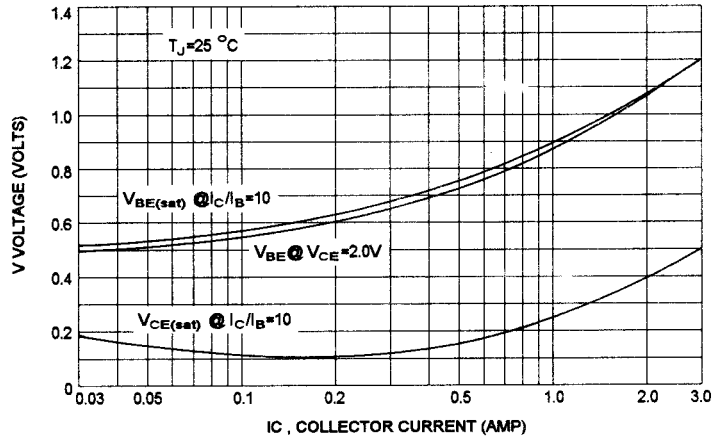

FIG-10 COLLECTOR CUT-OFF REGION

