



**TS1851
TS1852
TS1854**

1.8V INPUT/OUTPUT RAIL TO RAIL LOW POWER OPERATIONAL AMPLIFIERS

- OPERATING AT $V_{CC} = 1.8V$ to $6V$
- RAIL TO RAIL **INPUT & OUTPUT**
- EXTENDED V_{icm} ($V_{ee} - 0.2V$ to $V_{CC} + 0.2V$)
- LOW SUPPLY CURRENT ($120\mu A$)
- GAIN BANDWIDTH PRODUCT (**480kHz**)
- HIGH STABILITY (**able to drive 500pF**)
- ESD TOLERANCE (**2kV**)
- LATCH-UP IMMUNITY
- AVAILABLE IN **SOT23-5 MICROPACKAGE**

DESCRIPTION

The TS185x (Single, Dual & Quad) is operational amplifier able to operate with voltages as low as 1.8V and features both Input and Output Rail to Rail ($1.71 @ V_{CC} = 1.8V, R_L = 2k\Omega$), $120\mu A$ consumption current and 480kHz Gain Bandwidth Product.

With a such low consumption and a sufficient GBP for many applications, this Op-Amp is very well-suited for any kind of battery-supplied and portable equipment applications.

The TS1851 is housed in the space-saving 5 pin SOT23-5 package which simplifies the board design (outside dimensions are 2.8mm x 2.9mm).

APPLICATION

- Two-cell battery-powered systems
- Portable/Battery-powered electronic equipment
- Cordless phones
- Cellular phones
- Laptops
- PDAs

ORDER CODE

Part Number	Temperature Range	Package				SOT23 Marking
		N	D	P	L	
TS1851I/AI	-40, +125°C		•		•	K161/K162
TS1852I/AI		•	•	•		
TS1854I/AI		•	•	•		

N = Dual in Line Package (DIP)
D = Small Outline Package (SO) - also available in Tape & Reel (DT)
P = Thin Shrink Small Outline Package (TSSOP) - only available in Tape & Reel (PT)
L = Tiny Package (SOT23-5) - only available in Tape & Reel (LT)

PIN CONNECTIONS (top view)

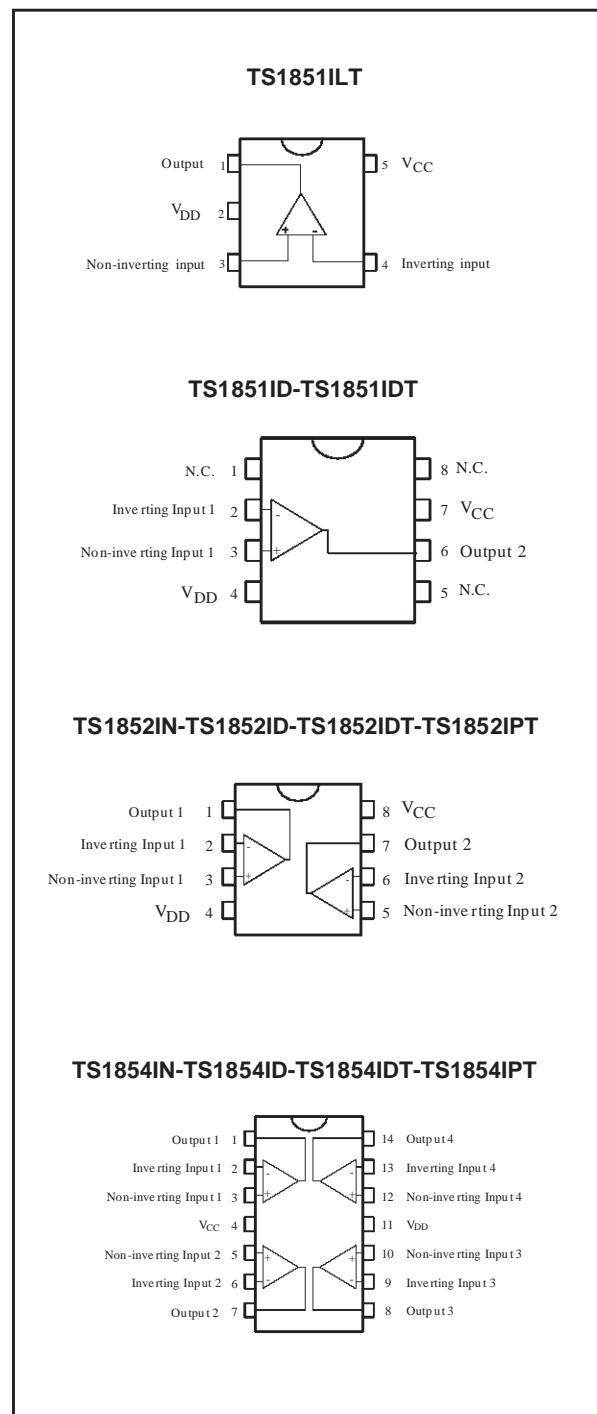

ABSOLUTE MAXIMUM RATINGS

Symbol	Parameter	Value	Unit
V_{CC}	Supply voltage ¹⁾	7	V
V_{id}	Differential Input Voltage ²⁾	± 1	V
V_i	Input Voltage ³⁾	-0.3 to $V_{CC} + 0.3$	V
T_{oper}	Operating Free Air Temperature Range	-40 to + 125	°C
T_{std}	Storage Temperature	-65 to +150	°C
T_j	Maximum Junction Temperature	150	°C
R_{thjc}	Thermal Resistance Junction to Case ⁴⁾		°C/W
	SOT23-5	81	
	DIP8	42	
	DIP14	32	
	SO8	28	
	SO14	22	
	TSSOP8	26	
	TSSOP14	21	
R_{thja}	Thermal Resistance Junction to Ambient - SOT23-5	256	°C/W
ESD	Human Body Model	2	kV
	Lead Temperature (soldering, 10sec)	260	°C

1. All voltages values, except differential voltage are with respect to network terminal.
2. Differential voltages are non-inverting input terminal with respect to the inverting input terminal.
3. The magnitude of input and output voltages must never exceed $V_{CC} + 0.3V$.
4. Short-circuits can cause excessive heating. Destructive dissipation can result from simultaneous short-circuit on all amplifiers

OPERATING CONDITIONS

Symbol	Parameter	Value	Unit
V_{CC}	Supply Voltage	1.8 to 6	V
V_{icm}	Common Mode Input Voltage Range ¹⁾	$V_{ee} - 0.2$ to $V_{CC} + 0.2$	V
V_{icm}	Common Mode Input Voltage Range ²⁾	V_{ee} to V_{CC}	V

1. At 25°C, for $1.8 \leq V_{CC} \leq 6V$, V_{icm} is extended to $V_{ee} - 0.2V$, $V_{CC} + 0.2V$.
2. In full temperature range, both Rails can be reached when V_{CC} does not exceed 5.5V.

TS1851-TS1852-TS1854

ELECTRICAL CHARACTERISTICS

$V_{CC} = +1.8V$, $V_{ee} = 0V$,

$T_{amb} = 25^{\circ}C$ (unless otherwise specified)

Symbol	Parameter	Min.	Typ.	Max.	Unit
V_{io}	Input Offset Voltage TS1851/2/4 TS1851A/2A/4A		0.1	3 1	mV
ΔV_{io}	Input Offset Voltage Drift		2		$\mu V/^{\circ}C$
I_{io}	Input Offset Current ¹⁾		1	9	nA
I_{ib}	Input Bias Current ¹⁾		10	50	nA
CMR	Common Mode Rejection Ratio $0 \leq V_{icm} \leq V_{CC}$	55	85		dB
SVR	Supply Voltage Rejection Ratio $V_{icm} = 0.5V$	70	80		dB
A_{vd}	Large Signal Voltage Gain $R_L = 10k\Omega$ $R_L = 2k\Omega$	80 70	100 88		dB
V_{OH}	High Level Output Voltage $R_L = 10k\Omega$ $R_L = 2k\Omega$	1.7 1.65	1.77 1.7		V
V_{OL}	Low Level Output Voltage $R_L = 10k\Omega$ $R_L = 2k\Omega$		40 62	70 90	mV
I_o	Output Source Current $V_{ID} = 100mV$, $V_O = V_{DD}$ Output Sink Current $V_{ID} = -100mV$, $V_O = V_{CC}$	2 2	29 46		mA
I_{CC}	Supply Current (per amplifier) $A_{VCL} = 1$, no load		120	170	μA
GBP	Gain Bandwidth Product $R_L = 10k\Omega$, $C_L = 100pF$, $f = 100kHz$	300	480		kHz
SR	Slew Rate $R_L = 10k\Omega$, $C_L = 100pF$, $AV = 1$	0.1	0.18		$V/\mu s$
ϕ_m	Phase Margin $C_L = 100pF$		60		Degrees
en	Input Voltage Noise		40		nV/\sqrt{Hz}
THD	Total Harmonic Distortion		0.01		%

1. Maximum values including unavoidable inaccuracies of the industrial test.

ELECTRICAL CHARACTERISTICS

$V_{CC} = +3V$, $V_{EE} = 0V$,

$T_{amb} = 25^{\circ}C$ (unless otherwise specified)

Symbol	Parameter	Min.	Typ.	Max.	Unit
V_{io}	Input Offset Voltage TS1851/2/4 TS1851A/2A/4A		0.1	3 1	mV
ΔV_{io}	Input Offset Voltage Drift		2		$\mu V/^{\circ}C$
I_{io}	Input Offset Current ¹⁾		1	9	nA
I_{ib}	Input Bias Current ¹⁾		10	55	nA
CMR	Common Mode Rejection Ratio $0 \leq V_{icm} \leq V_{CC}$	60	90		dB
SVR	Supply Voltage Rejection Ratio $V_{icm} = V_{CC}/2$	70	85		dB
A_{vd}	Large Signal Voltage Gain $R_L = 10k\Omega$ $R_L = 2k\Omega$	83 74	99 90		dB
V_{OH}	High Level Output Voltage $R_L = 10k\Omega$ $R_L = 2k\Omega$	2.9 2.85	2.96 2.94		V
V_{OL}	Low Level Output Voltage $R_L = 10k\Omega$ $R_L = 2k\Omega$		10 46	90 100	mV
I_o	Output Source Current $V_{ID} = 100mV$, $V_O = V_{DD}$ Output Sink Current $V_{ID} = -100mV$, $V_O = V_{CC}$	2 2	47 47		mA
I_{CC}	Supply Current (per amplifier) $A_{VCL} = 1$, no load		150	200	μA
GBP	Gain Bandwidth Product $R_L = 10k\Omega$, $C_L = 100pF$, $f = 100kHz$	370	600		kHz
SR	Slew Rate $R_L = 10k\Omega$, $C_L = 100pF$, $AV = 1$	0.12	0.2		V/ μs
ϕ_m	Phase Margin $C_L = 100pF$		60		Degrees
en	Input Voltage Noise		40		nV/ \sqrt{Hz}
THD	Total Harmonic Distortion		0.01		%

1. Maximum values including unavoidable inaccuracies of the industrial test.

TS1851-TS1852-TS1854

ELECTRICAL CHARACTERISTICS

$V_{CC} = +5V$, $V_{EE} = 0V$,

$T_{amb} = 25^{\circ}C$ (unless otherwise specified)

Symbol	Parameter	Min.	Typ.	Max.	Unit
V_{io}	Input Offset Voltage TS1851/2/4 TS1851A/2A/4A		0.1	3 1	mV
ΔV_{io}	Input Offset Voltage Drift		2		$\mu V/^{\circ}C$
I_{io}	Input Offset Current ¹⁾		1	9	nA
I_{ib}	Input Bias Current ¹⁾		16	63	nA
CMR	Common Mode Rejection Ratio $0 \leq V_{icm} \leq V_{CC}$	65	95		dB
SVR	Supply Voltage Rejection Ratio $V_{icm} = V_{CC}/2$	70	90		dB
A_{vd}	Large Signal Voltage Gain $R_L = 10k\Omega$ $R_L = 2k\Omega$	85 77	97 93		dB
V_{OH}	High Level Output Voltage $R_L = 10k\Omega$ $R_L = 2k\Omega$	4.85 4.8	4.95 4.91		V
V_{OL}	Low Level Output Voltage $R_L = 10k\Omega$ $R_L = 2k\Omega$		40 80	180 200	mV
I_o	Output Source Current $V_{ID} = 100mV$, $V_O = V_{DD}$ Output Sink Current $V_{ID} = -100mV$, $V_O = V_{CC}$	2 2	48 48		mA
I_{CC}	Supply Current (per amplifier) $A_{VCL} = 1$, no load		162	220	μA
GBP	Gain Bandwidth Product $R_L = 10k\Omega$, $C_L = 100pF$, $f = 100kHz$	380	630		kHz
SR	Slew Rate $R_L = 10k\Omega$, $C_L = 100pF$, $AV = 1$	0.13	0.25		$V/\mu s$
ϕ_m	Phase Margin $C_L = 100pF$		60		Degrees
en	Input Voltage Noise		40		nV/\sqrt{Hz}
THD	Total Harmonic Distortion		0.01		%

1. Maximum values including unavoidable inaccuracies of the industrial test.

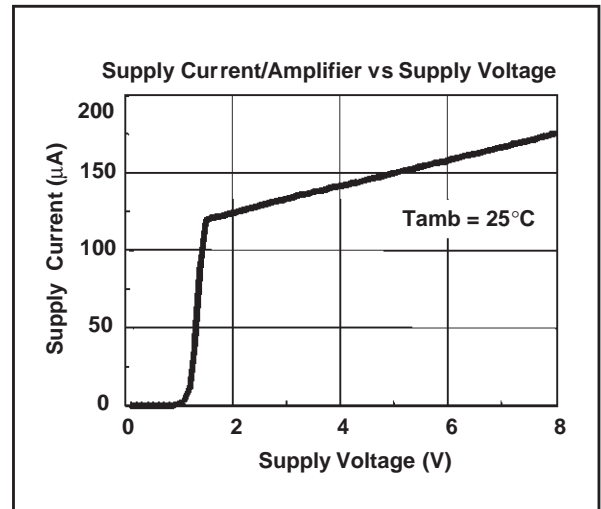
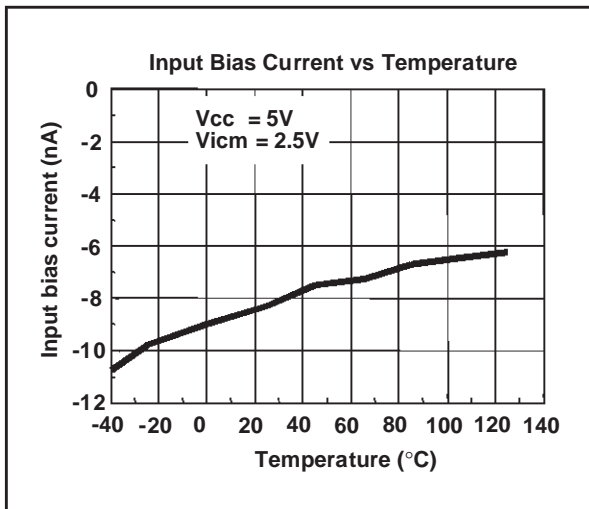
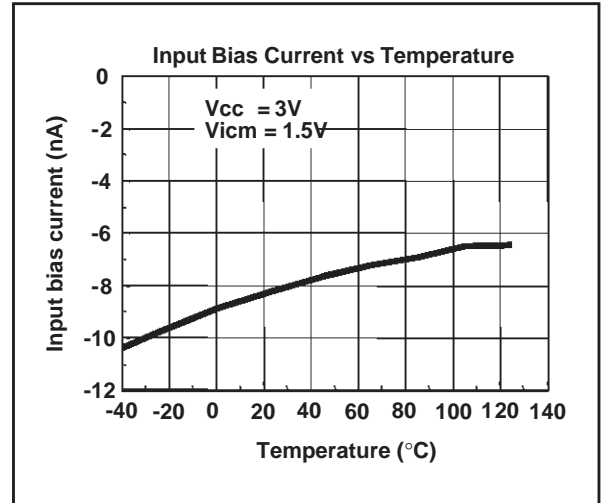
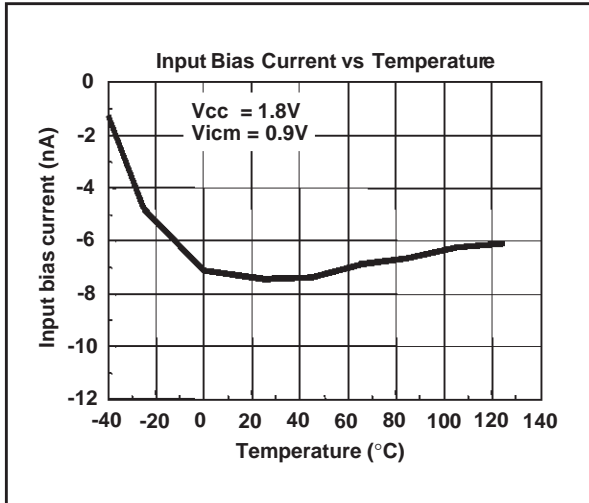
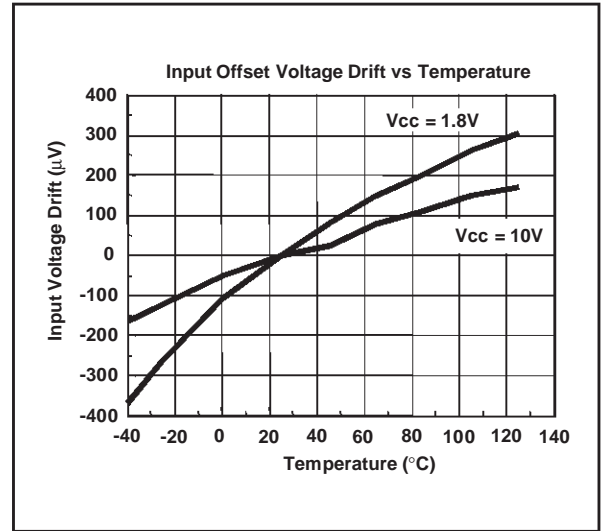
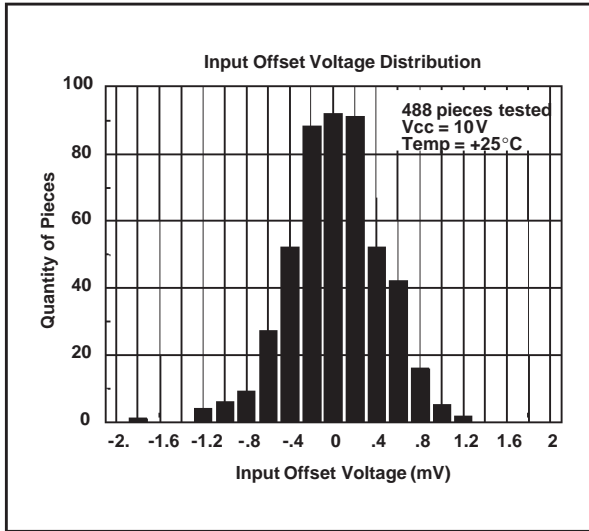

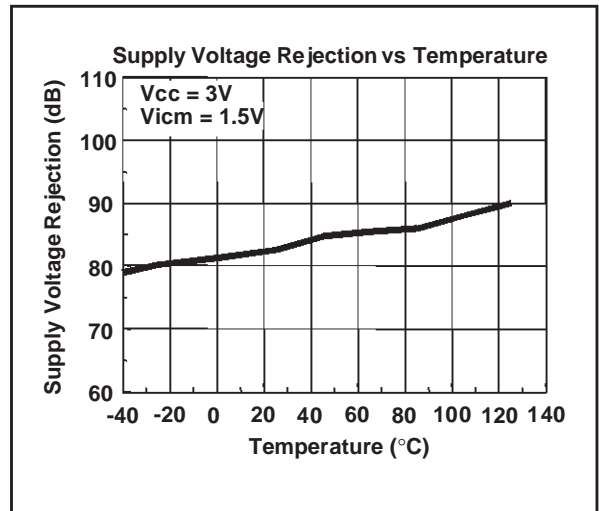
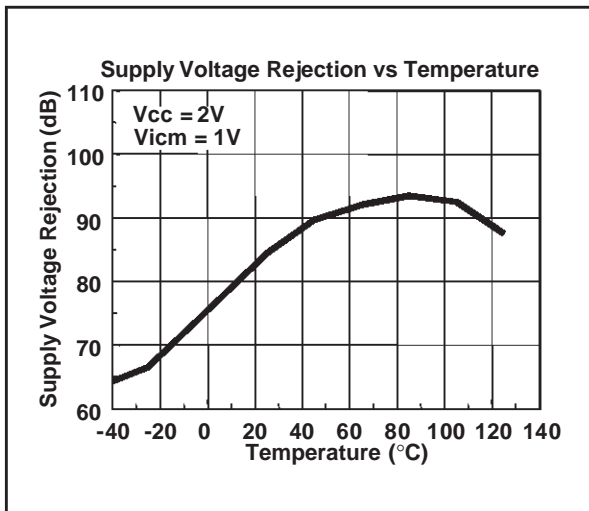
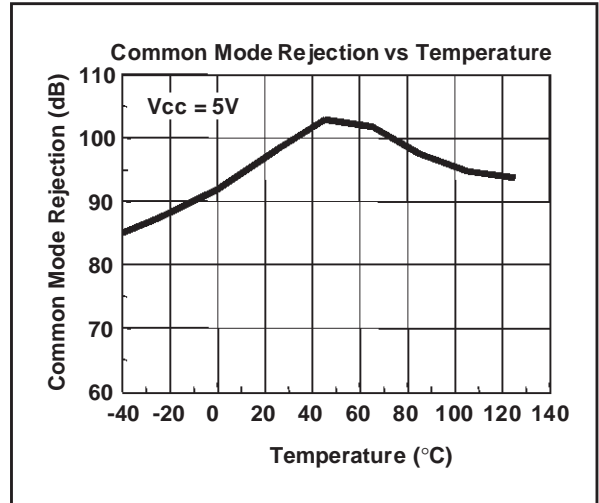
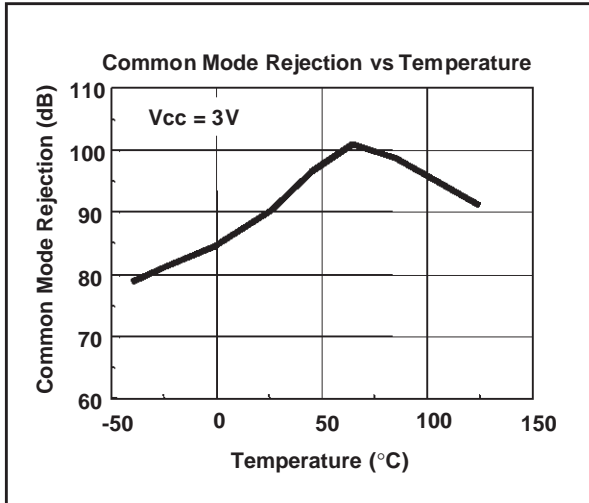
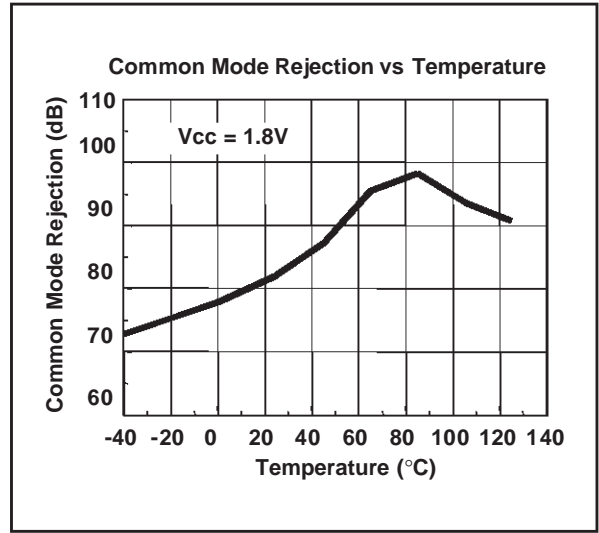
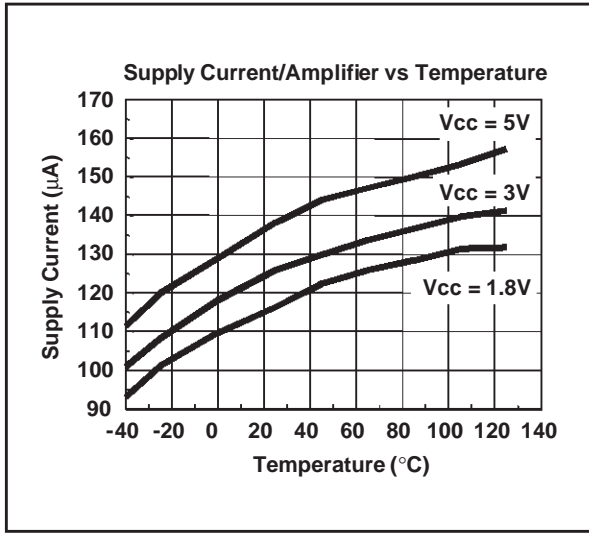

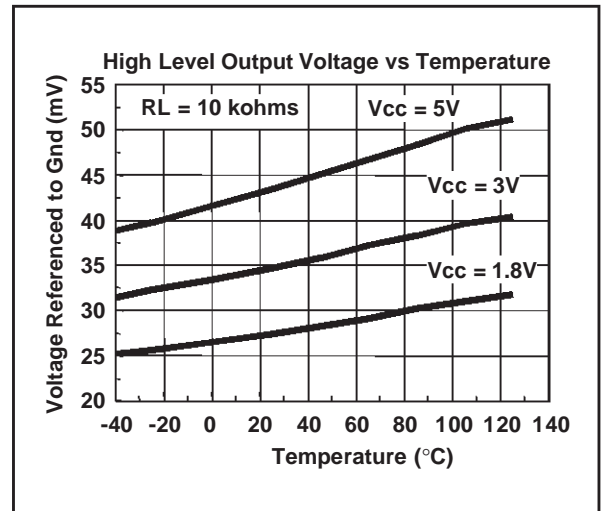
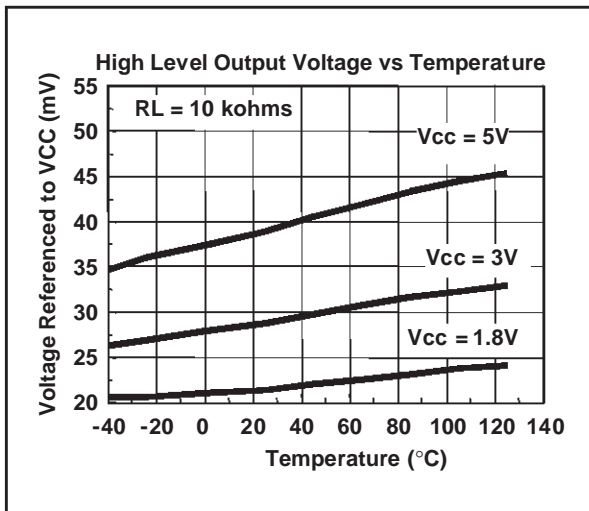
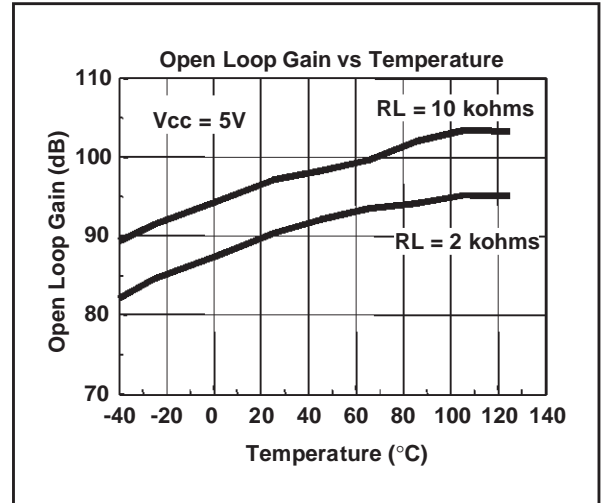
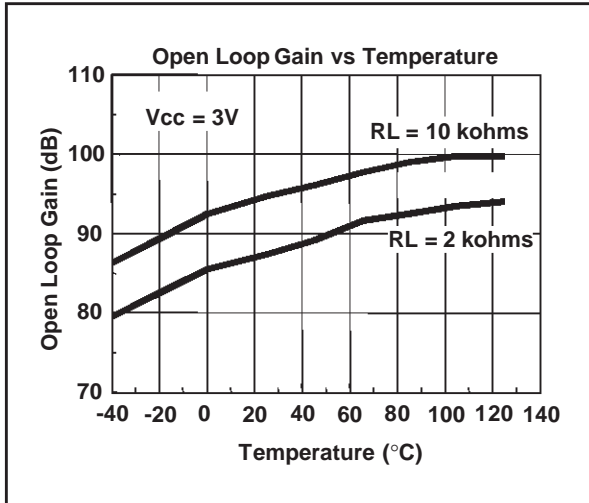
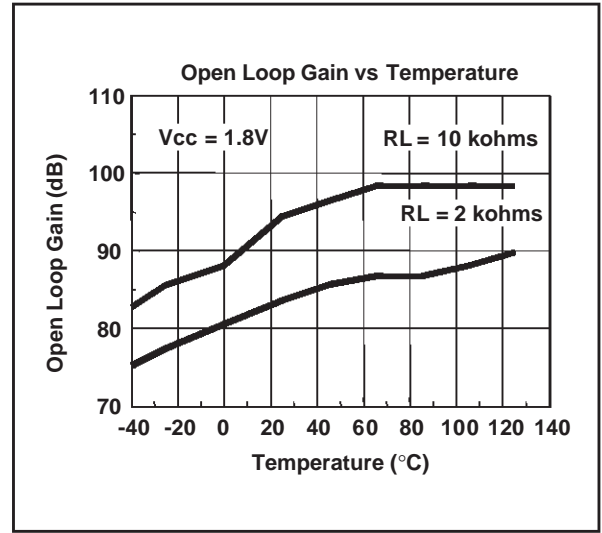
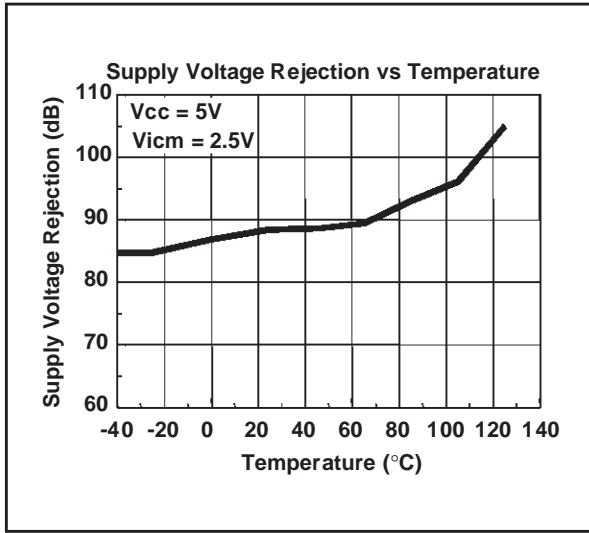

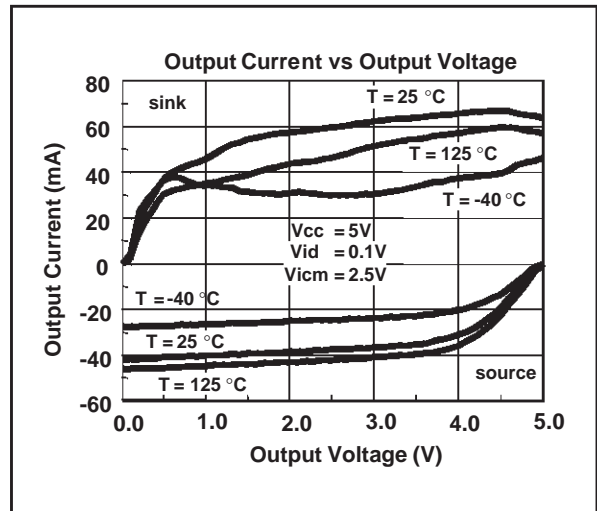
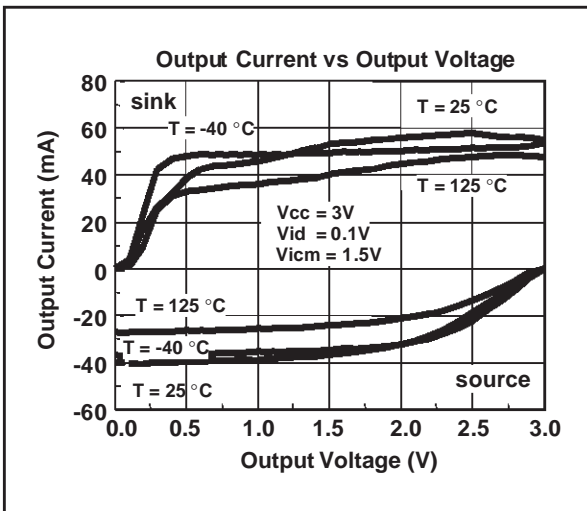
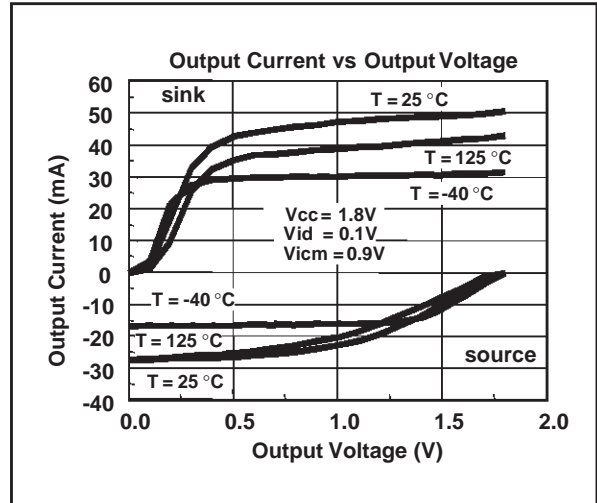
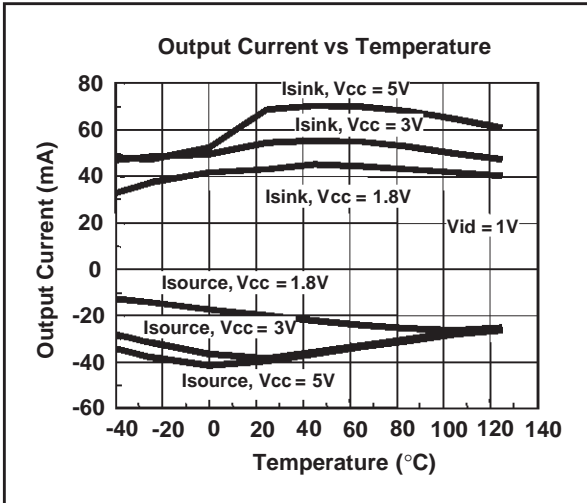
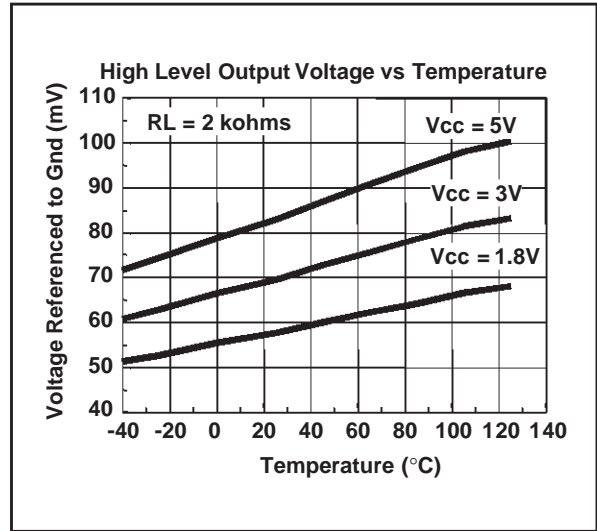
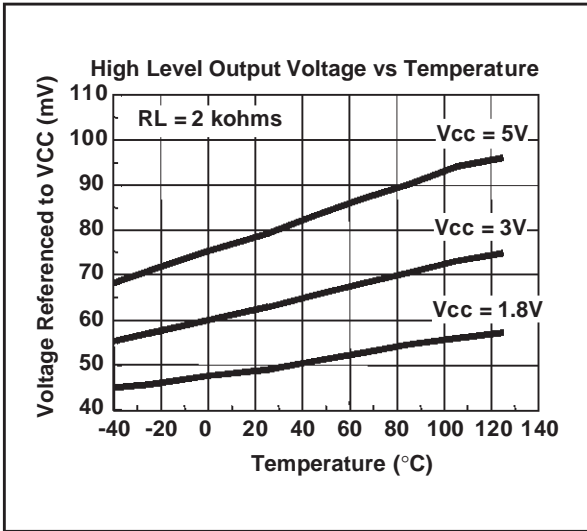

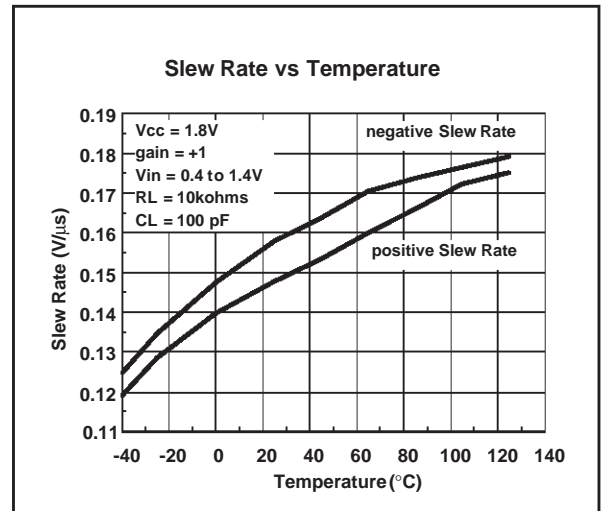
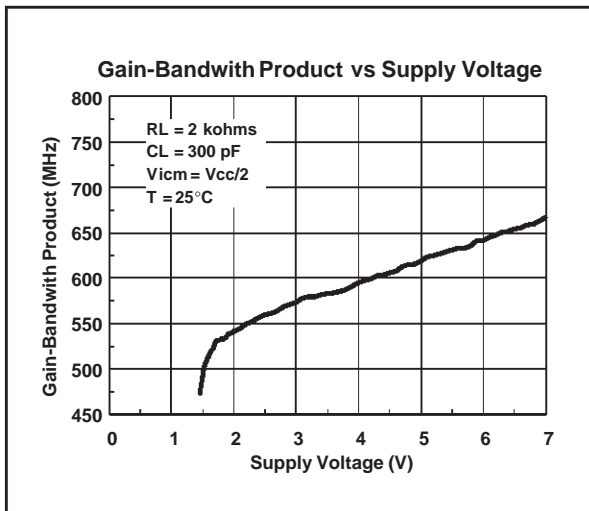
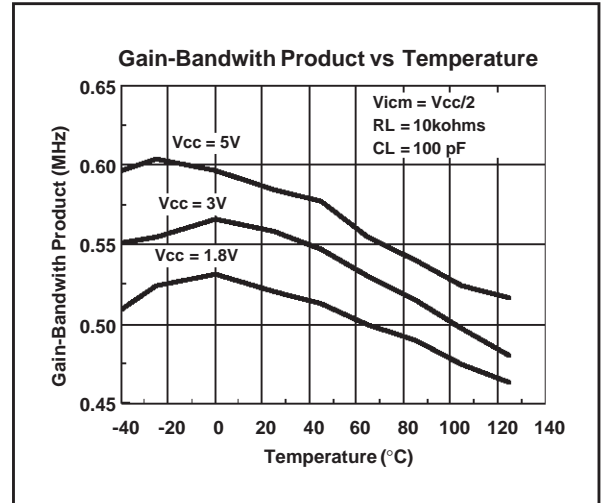
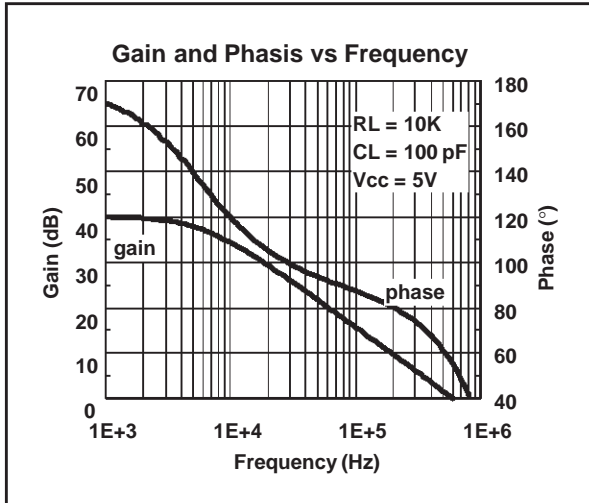
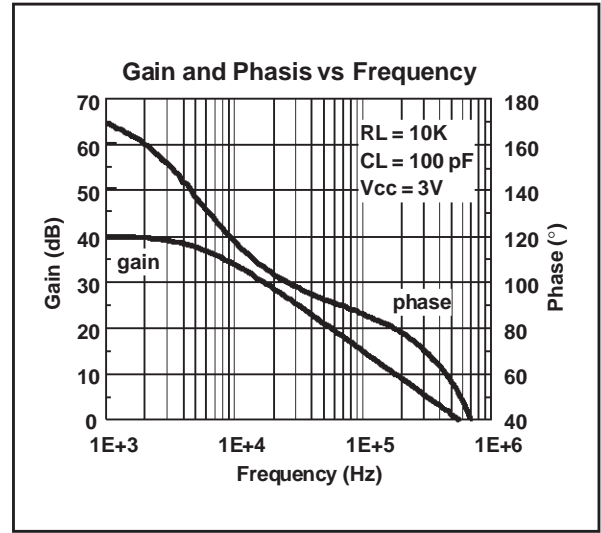
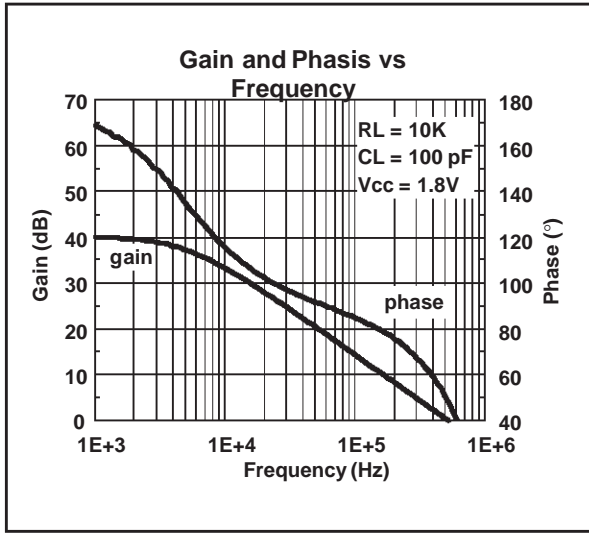

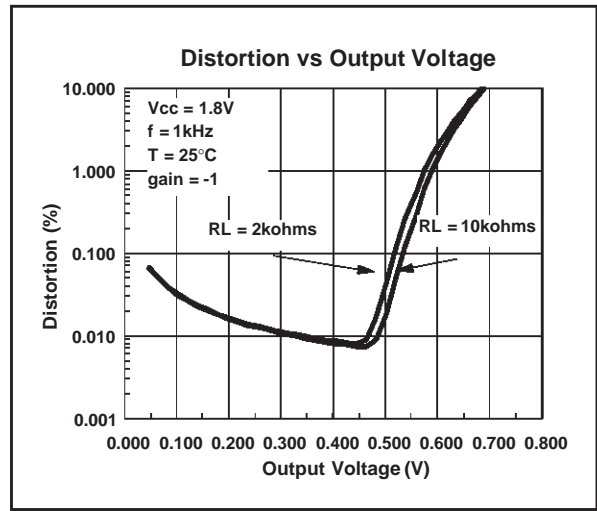
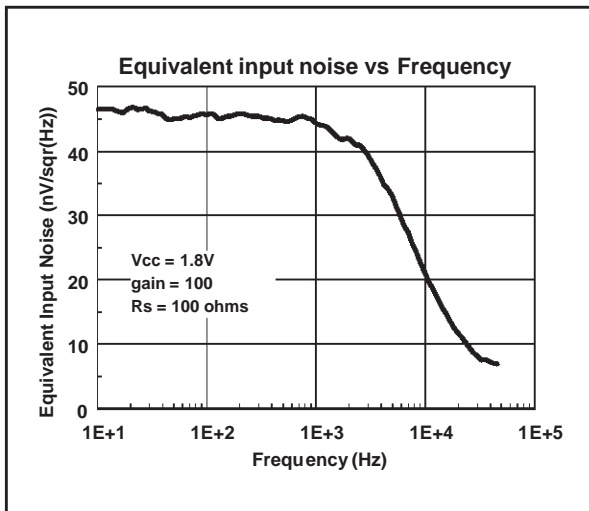
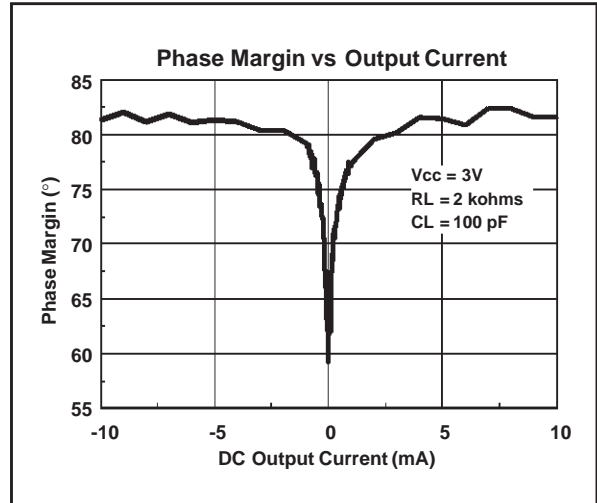
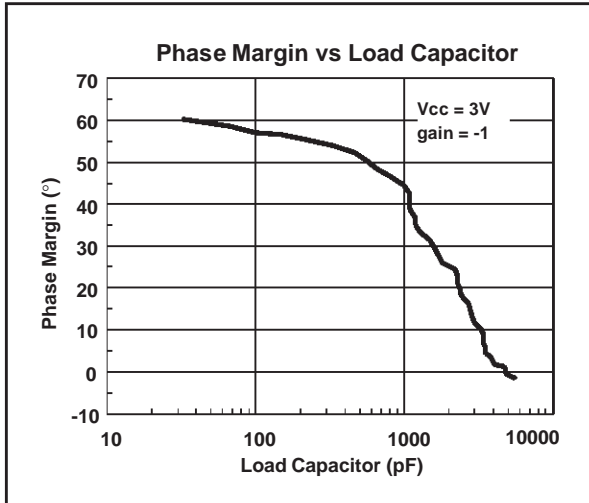
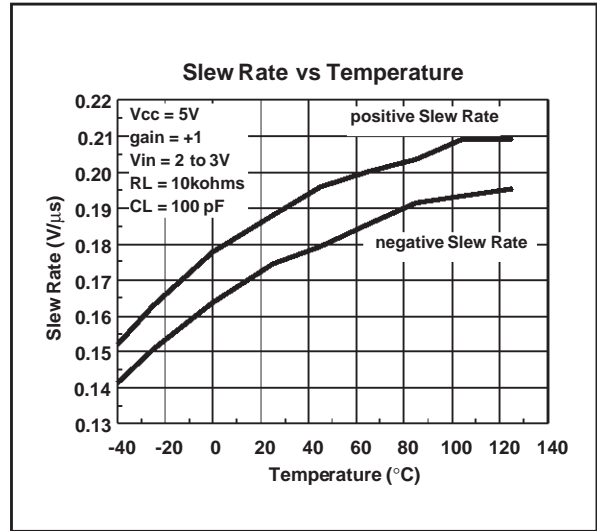
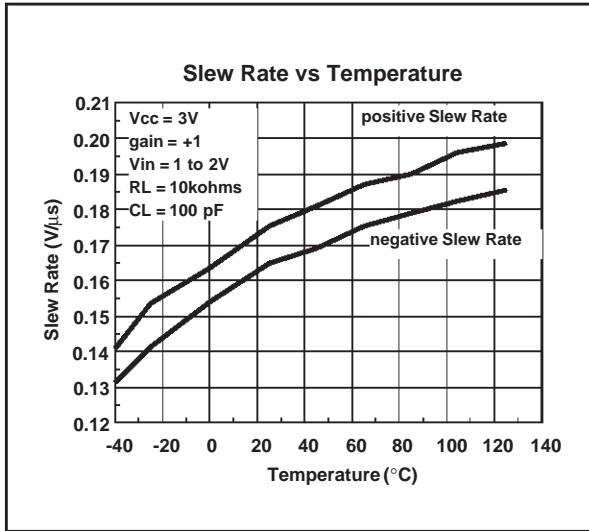

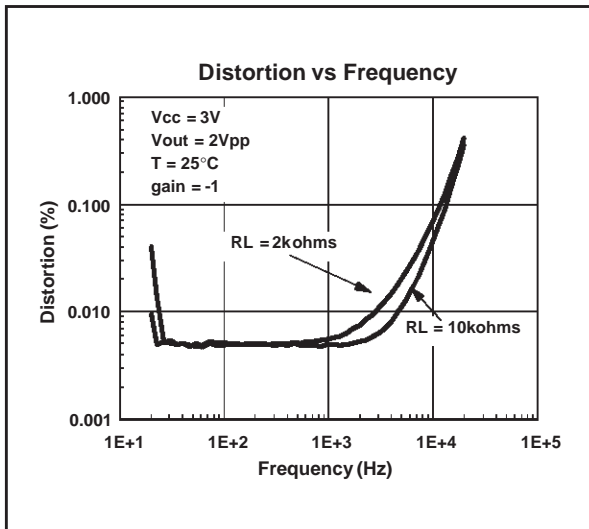
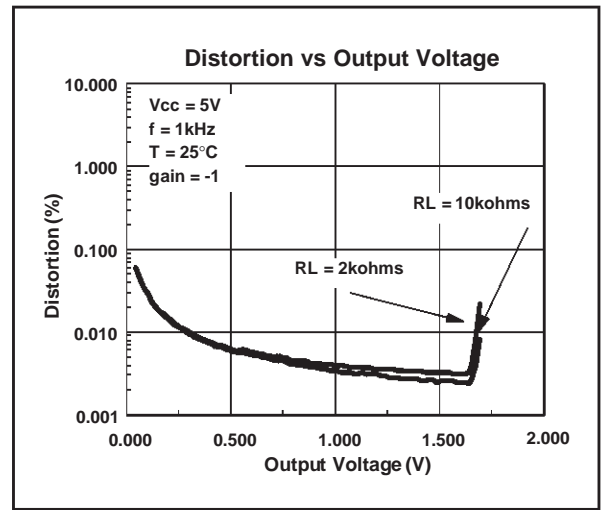
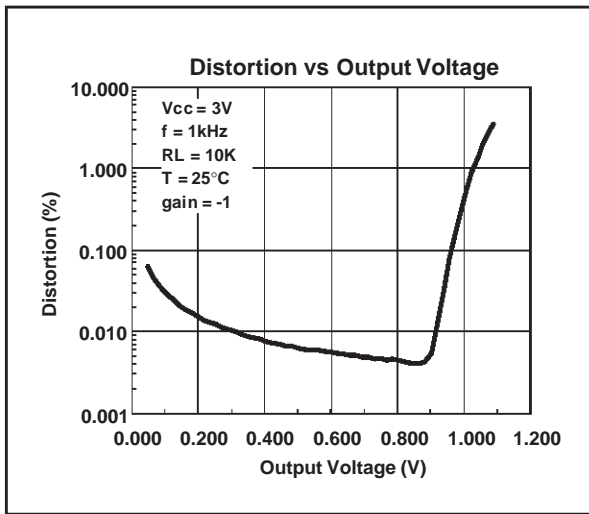

TS1851-TS1852-TS1854

TS1851ID - TS1852ID

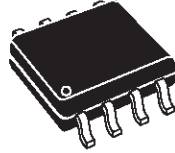

PACKAGE MECHANICAL DATA
8 PINS - PLASTIC MICROPACKAGE (SO)

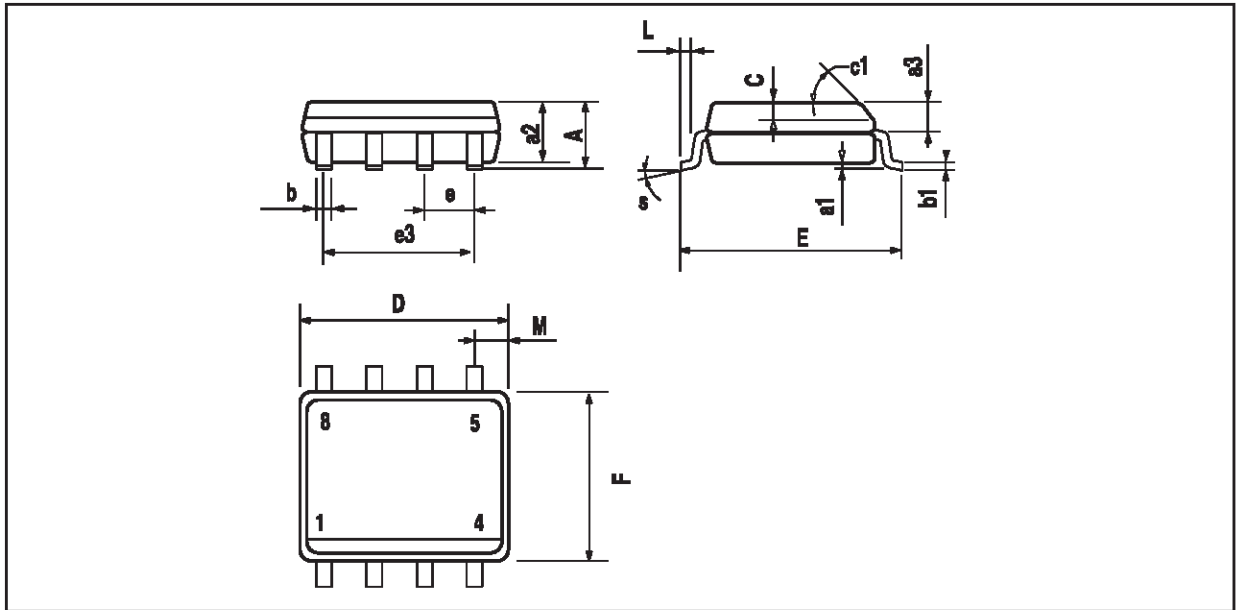

Dim.	Millimeters			Inches		
	Min.	Typ.	Max.	Min.	Typ.	Max.
A			1.75			0.069
a1	0.1		0.25	0.004		0.010
a2			1.65			0.065
a3	0.65		0.85	0.026		0.033
b	0.35		0.48	0.014		0.019
b1	0.19		0.25	0.007		0.010
C	0.25		0.5	0.010		0.020
c1	45° (typ.)					
D	4.8		5.0	0.189		0.197
E	5.8		6.2	0.228		0.244
e		1.27			0.050	
e3		3.81			0.150	
F	3.8		4.0	0.150		0.157
L	0.4		1.27	0.016		0.050
M			0.6			0.024
S	8° (max.)					

TS1852IPT

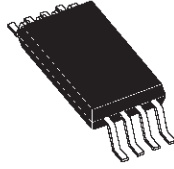

PACKAGE MECHANICAL DATA
8 PINS - THIN SHRINK SMALL OUTLINE PACKAGE

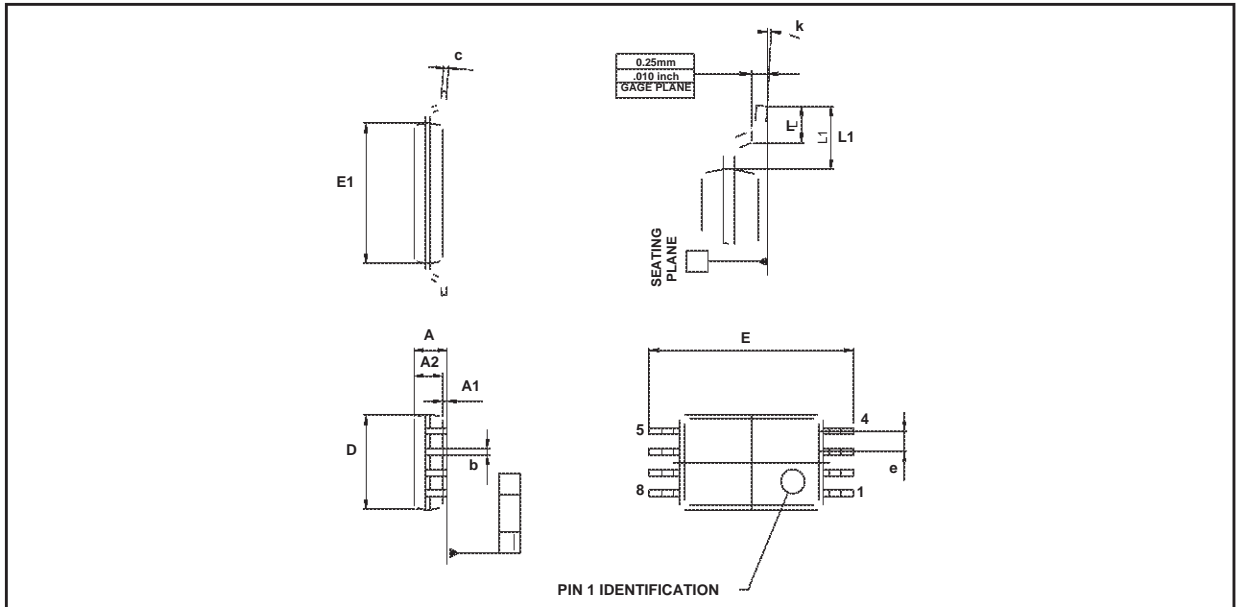

Dim.	Millimeters			Inches		
	Min.	Typ.	Max.	Min.	Typ.	Max.
A			1.20			0.05
A1	0.05		0.15	0.01		0.006
A2	0.80	1.00	1.05	0.031	0.039	0.041
b	0.19		0.30	0.007		0.15
c	0.09		0.20	0.003		0.012
D	2.90	3.00	3.10	0.114	0.118	0.122
E		6.40			0.252	
E1	4.30	4.40	4.50	0.169	0.173	0.177
e		0.65			0.025	
k	0°		8°	0°		8°
l	0.50	0.60	0.75	0.09	0.0236	0.030

TS1851-TS1852-TS1854

TS1854ID

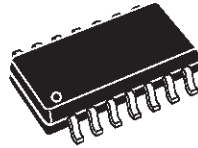

PACKAGE MECHANICAL DATA
14 PINS - PLASTIC MICROPACKAGE (SO)

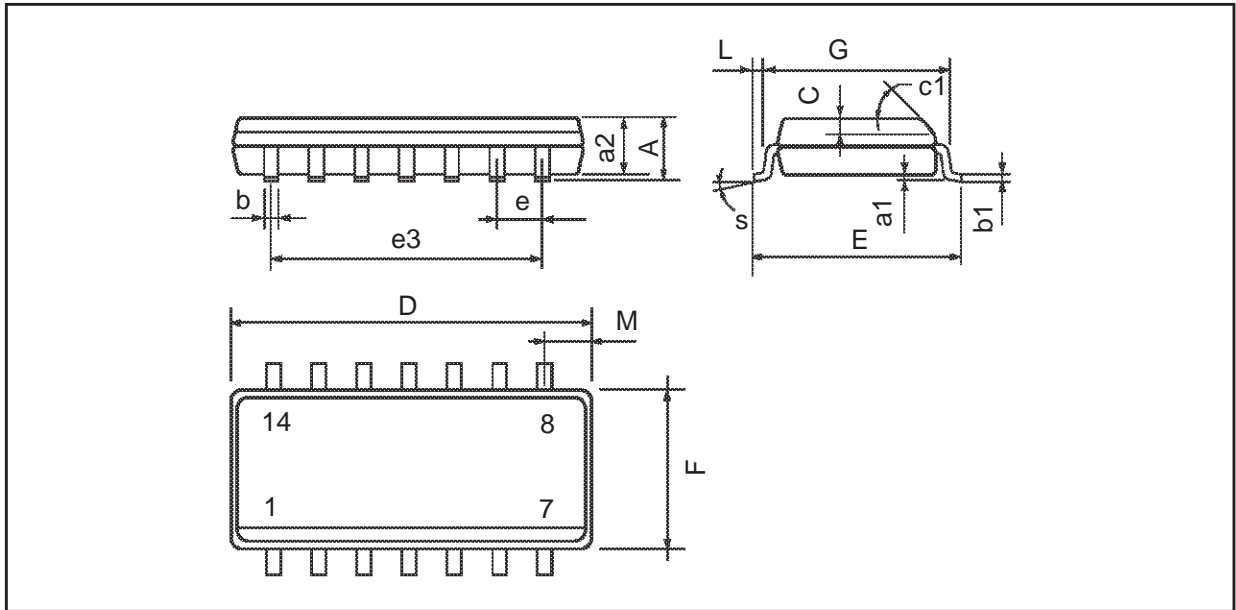

Dim.	Millimeters			Inches		
	Min.	Typ.	Max.	Min.	Typ.	Max.
A			1.75			0.069
a1	0.1		0.2	0.004		0.008
a2			1.6			0.063
b	0.35		0.46	0.014		0.018
b1	0.19		0.25	0.007		0.010
C		0.5			0.020	
c1	45° (typ.)					
D (1)	8.55		8.75	0.336		0.344
E	5.8		6.2	0.228		0.244
e		1.27			0.050	
e3		7.62			0.300	
F (1)	3.8		4.0	0.150		0.157
G	4.6		5.3	0.181		0.208
L	0.5		1.27	0.020		0.050
M			0.68			0.027
S	8° (max.)					

Note : (1) D and F do not include mold flash or protrusions - Mold flash or protrusions shall not exceed 0.15mm (.066 inc) ONLY FOR DATA BOOK.

TS1854IPT

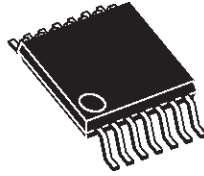

PACKAGE MECHANICAL DATA
14 PINS - THIN SHRINK SMALL OUTLINE PACKAGE

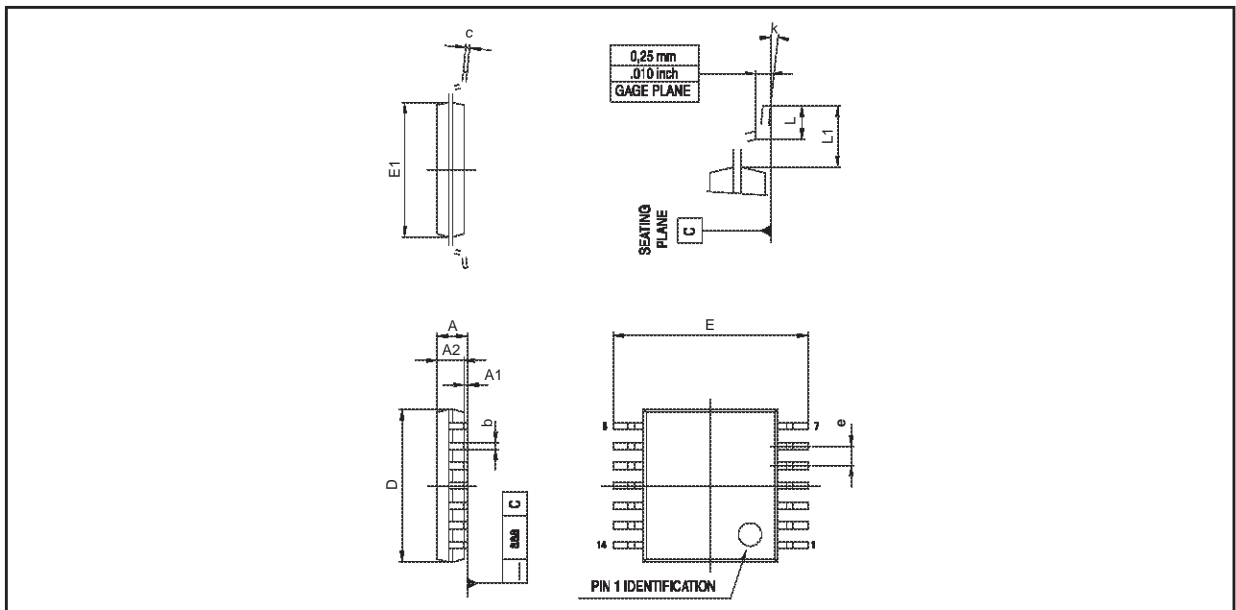

Dim.	Millimeters			Inches		
	Min.	Typ.	Max.	Min.	Typ.	Max.
A			1.20			0.05
A1	0.05		0.15	0.01		0.006
A2	0.80	1.00	1.05	0.031	0.039	0.041
b	0.19		0.30	0.007		0.15
c	0.09		0.20	0.003		0.012
D	4.90	5.00	5.10	0.192	0.196	0.20
E		6.40			0.252	
E1	4.30	4.40	4.50	0.169	0.173	0.177
e		0.65			0.025	
k	0°		8°	0°		8°
l	0.50	0.60	0.75	0.09	0.0236	0.030

TS1851-TS1852-TS1854

TS1851ILT

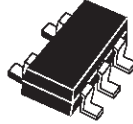

PACKAGE MECHANICAL DATA
5 PINS - TINY PACKAGE (SOT23)

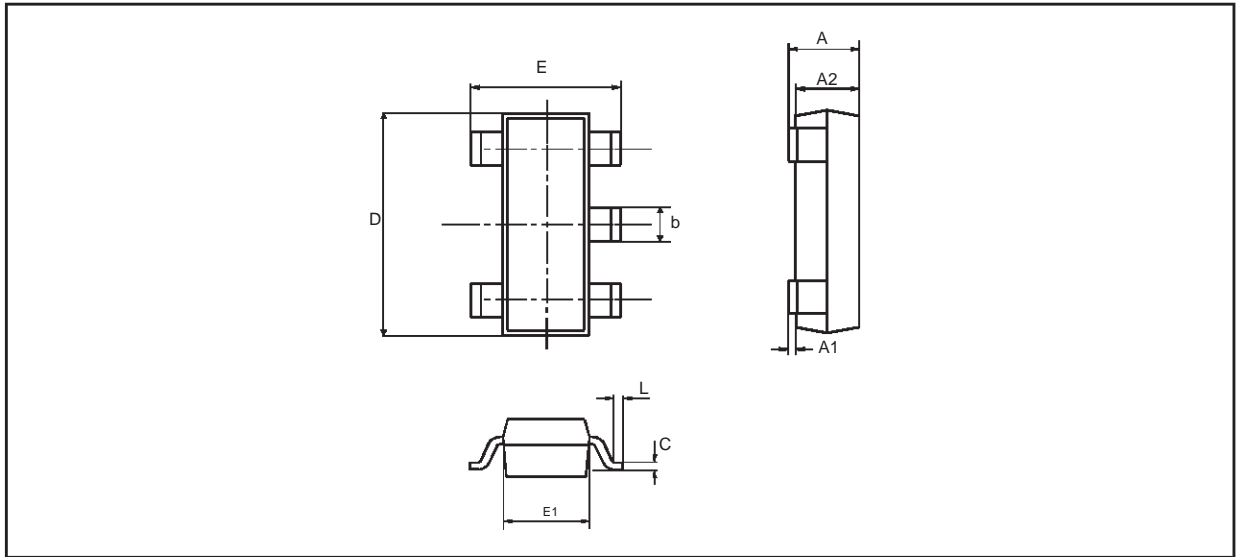

Dim.	Millimeters			Inches		
	Min.	Typ.	Max.	Min.	Typ.	Max.
A	0.90	1.20	1.45	0.035	0.047	0.057
A1	0		0.15			0.006
A2	0.90	1.05	1.30	0.035	0.041	0.051
B	0.35	0.40	0.50	0.014	0.016	0.020
C	0.09	0.15	0.20	0.004	0.006	0.008
D	2.80	2.90	3.00	0.110	0.114	0.118
D1		1.90			0.075	
e		0.95			0.037	
E	2.60	2.80	3.00	0.102	0.110	0.0118
F	1.50	1.60	1.75	0.059	0.063	0.069
L	0.10	0.5	0.60	0.004	0.014	0.024
K	0d		10d	0d		10d

Information furnished is believed to be accurate and reliable. However, STMicroelectronics assumes no responsibility for the consequences of use of such information nor for any infringement of patents or other rights of third parties which may result from its use. No license is granted by implication or otherwise under any patent or patent rights of STMicroelectronics. Specifications mentioned in this publication are subject to change without notice. This publication supersedes and replaces all information previously supplied. STMicroelectronics products are not authorized for use as critical components in life support devices or systems without express written approval of STMicroelectronics.

© The ST logo is a registered trademark of STMicroelectronics

© 2000 STMicroelectronics - Printed in Italy - All Rights Reserved
STMicroelectronics GROUP OF COMPANIES

Australia - Brazil - China - Finland - France - Germany - Hong Kong - India - Italy - Japan - Malaysia - Malta - Morocco
Singapore - Spain - Sweden - Switzerland - United Kingdom

© <http://www.st.com>

